

DISPLAY Elektronik GmbH

DATA SHEET

LCD MODULE

DEM 20232 SYH-LY-CYR22

Product Specification

Version: 3.1.3

19/Sep/2008

GENERAL SPECIFICATION

MODULE NO. :

DEM 20232 SYH-LY-CYR22

CUSTOMER P/N

VERSION NO.	CHANGE DESCRIPTION	DATE
0	ORIGINAL VERSION	09.11.2000
1	CHANGE CONTENTS	16.11.2000
2	ADD S6A0069-22	07.03.2001
3	ADD HOLES	08.08.2001
3.1.3	CHANGE IC	19.09.2008

PREPARED BY: XYP

DATE: 19.09.2008

APPROVED BY: MH

DATE: 19.09.2008

CONTENTS

1.FUNCTIONS & FEATURES ----- 2

2. MECHANICAL SPECIFICATIONS ----- 2

3. EXTERNAL DIMENSIONS.----- 3

4. BLOCK DIAGRAM----- 4

5. PIN ASSIGNMENT ----- 4

6. PCB DRAWING AND DESCRIPTION ----- 5

7. BACKLIGHT ELECTRICAL/OPTICAL SPECIFICATIONS ----- 6

8. DISPLAY DATA RAM (DDRAM)----- 6

9. MAXIMUM ABSOLUTE LIMIT ----- 6

10. ELECTRICAL CHARACTERISTICS ----- 7

11. CONTROL AND DISPLAY COMMAND ----- 9

12. CHARACTER PATTERN----- 10

13. LCD MODULES HANDLING PRECAUTIONS----- 11

14. OTHERS ----- 11

1.FUNCTIONS & FEATURES

MODULE NAME	LCD TYPE
DEM 20232 SYH-LY-CYR22	STN Yellow Green Transflective Positive Mode

- Viewing Direction : 6 o'clock
- Driving Scheme : 1/16 Duty Cycle, 1/5 Bias
- Power Supply Voltage : 5 Volt (typ.)
- Backlight Color : LED, Lightbox, Yellow Green
- V_{LCD} Adjustable For Best Contrast : 4.5 Volt (typ.)
- Display contents : 20 x 2 Characters (5 x 8 dots, Format:208 Kinds)
- Internal Memory : CGROM (13,200 bits)
: CGRAM (64 x 8 bits)
: DDRAM (80 x 8 bits for Digits)
- CGROM : CGROM of the ST7066-0T (English-Cyrillic)
- Interface : Easy Interface with a 4-bit or 8-bit MPU
- Operating Temperature : -20°C to +70°C
- Storage Temperature : -30°C to +80°C

2. MECHANICAL SPECIFICATIONS

- Module Size : 146.00 x 43.00 x 14.00 mm
- Character Pitch : 5.90 x 10.70 mm
- Character Size : 4.90 x 8.30 mm
- Character Font : 5 x 8 dots
- Dot Size : 0.90 x 0.95 mm
- Dot Pitch : 1.00 x 1.05 mm

3. EXTERNAL DIMENSIONS.

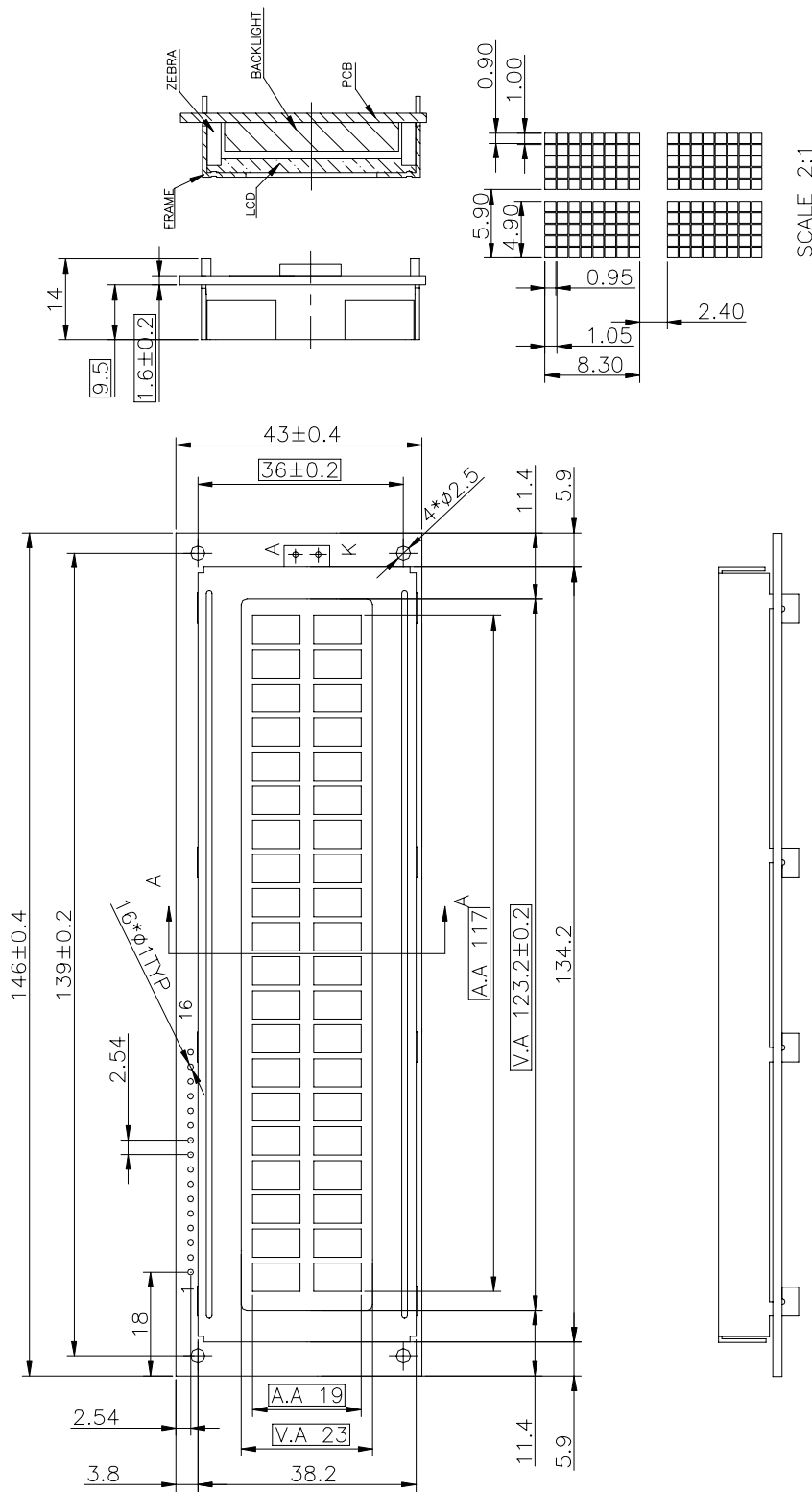

REMARKS:
1.UNMARKED TOLERANCE IS ±0.3;
2.ALL MATERIAL COMPLY WITH ROHS.

4. BLOCK DIAGRAM

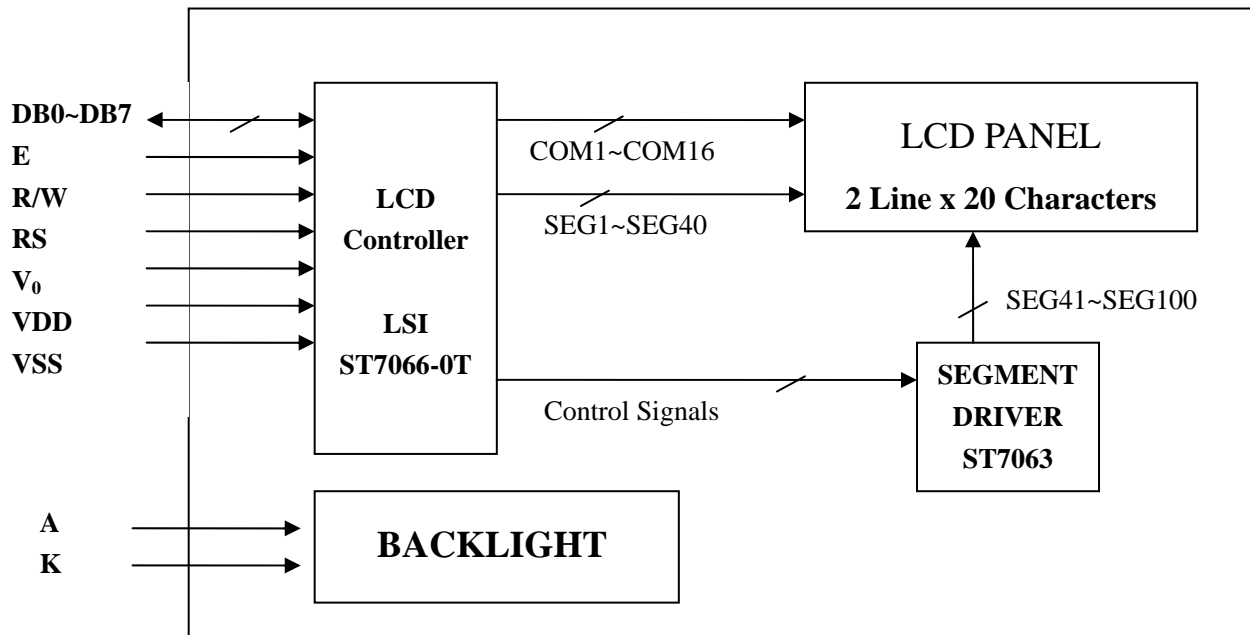

5. PIN ASSIGNMENT

Pin No.	Symbol	Function
1	V _{SS}	Ground
2	V _{DD}	Power supply
3	V ₀	Power Supply for LCD
4	RS	Select Display Data("H") or Instructions("L")
5	R/W	Read or Write Select Signal
6	E	Read/Write Enable Signal
7	DB0	Display Data Signal
8	DB1	
9	DB2	
10	DB3	
11	DB4	
12	DB5	
13	DB6	
14	DB7	
15	LED – (K)	Please also refer to 6. PCB drawing and description.
16	LED + (A)	Please also refer to 6. PCB drawing and description.

6. PCB DRAWING AND DESCRIPTION

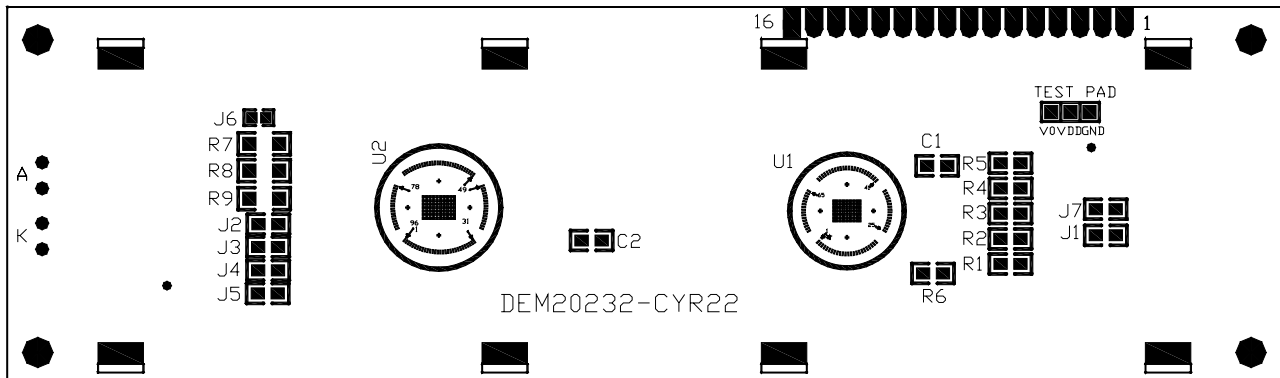

Note: The PCB drawing just for reference!

DESCRIPTION:

6-1-1. The polarity of the pin 15 and the pin 16

J3,J5	J2,J4	LED Polarity	
		15 Pin	16 Pin
Each Closed	Each open	Cathode	Anode
Each open	Each Closed	Anode	Cathode

Note: on application module, J2=J4= open, J3=J5=0 Ohm

6-1-2. The J1 is metal-bezel GND to module GND and J7 is mounting holes GND to module GND.

Note: on application module, J1=J7=0 Ohm

6-1-3. The LED resistor should be bridged when the J6 is solder-Bridge.

Note: on application module, J6=open

6-1-4. The R7 and R8 is the LED resistor.

Note: on application module R7=R8=5.6 Ohm

7. BACKLIGHT ELECTRICAL/OPTICAL SPECIFICATIONS (Ta=-20~+70°C)

Electrical/Optical Specifications

	SYMBOL	MIN.	TYP.	MAX.	UNIT	CONDITIONS
Forward Voltage	V _f	3.7	4.1	4.5	V	I _f = 270 mA
Forward Current	I _f		270		mA	
Power Disdipation	P _d		1.11		W	I _f = 270 mA
Reverse Voltage	V _R		10.0		V	
Reverse Current	I _R		0.20		mA	
Luminous Intensity	I _v	100	150		cd/m ²	I _f = 270 mA
Emission Wavelength	λ _P	569	572	575	nm	I _f =10mA Ta=25°C
Spectral Range	Δλ		35		nm	Each chip

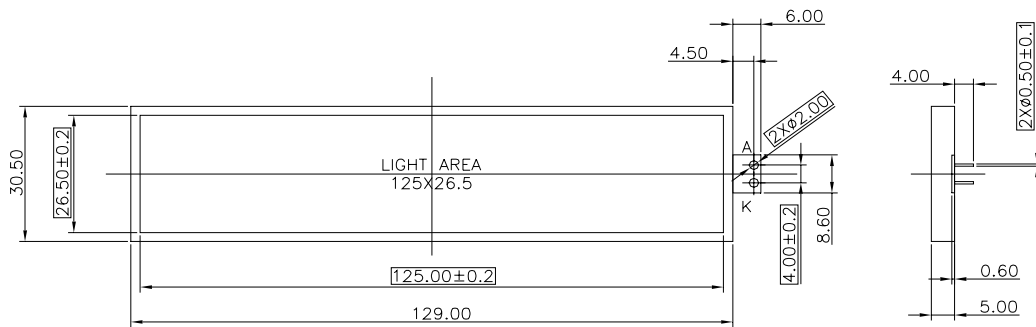

REMARKS:
 1.UNMARKED TOLERANCE IS ±0.3;
 2.ALL MATERIAL COMPLY WITH ROHS;
 3.color: yellow-green;

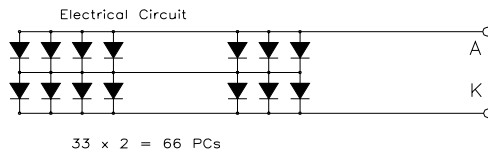

8. DISPLAY DATA RAM (DDRAM)

	1	2	3	4	5	6	7	8	9	10	11	12	13	14	15	16	17	18	19	20	← Display position
FIRST LINE	00	01	02	03	04	05	06	07	08	09	0A	0B	0C	0D	0E	0F	10	11	12	13	← DDRAM Address
SECOND LINE	40	41	42	43	44	45	46	47	48	49	4A	4B	4C	4D	4E	4F	50	51	52	53	

9. MAXIMUM ABSOLUTE LIMIT

Item	Symbol	Standard value	Unit
Power supply voltage(1)	V _{DD}	-0.3~+7.0	V
Power supply voltage(2)	V _{LCD}	V _{DD} -15.0~V _{DD} +0.3	V
Input voltage	V _{IN}	-0.3~V _{DD} +0.3	V
Operating temperature	T _{opr}	-20~+70	°C
Storage temperature	T _{stg}	-30~+80	°C

*Voltage greater than above may damage to the Circuit. V_{DD} > V₁ > V₂ > V₃ > V₄ > V₅

10. ELECTRICAL CHARACTERISTICS

10-1 DC Characteristics ($V_{DD}=4.5V\sim 5.5V, T_a=-20\sim +70^{\circ}C$)

Item	Symbol	Standard Value			Test Condition	Unit
		MIN	TYP	MAX		
Operating Voltage	V_{DD}	4.5	5	5.5	-----	V
Supply Current	I_{DD}	----	0.35	0.6	$V_{DD}=5V, f_{osc}=270kHz$	mA
LCD Driving Voltage	V_{LCD}	3.0	4.5	13.0	$V_{DD}-V_5$	V

10-2 AC Characteristics ($V_{DD}=5V, T_a=-20\sim +70^{\circ}C$)

10-2-1 Write mode (writing data from MPU to ST7066)

Characteristic	Symbol	Min	Type	Max	Unit	Test PIN
E Cycle Time	t_c	1200	---	---	ns	E
E Rise Time	t_R	---	---	25	ns	E
E Fall Time	t_F	---	---	25	ns	E
E Pulse width (High,Low)	t_{pw}	140	---	---	ns	E
R/W and RS Set-up Time	T_{AS}	0	---	---	ns	R/W,RS
R/W and RS Hold Time	T_{AH}	10	---	---	ns	R/W,RS
Data Set-up Time	T_{DSW}	40	---	---	ns	DB0~DB7
Data Hold Time	t_H	10	---	---	ns	DB0~DB7

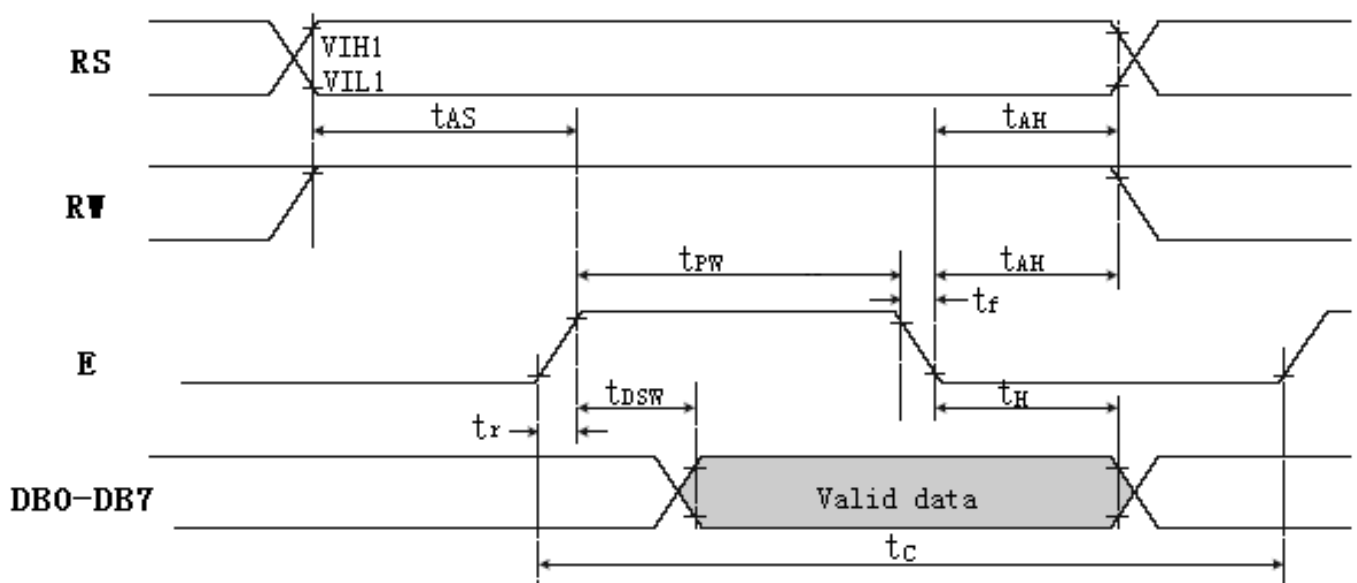

10-2-2 Read mode (reading data from MPU to ST7066)

Characteristic	Symbol	Min	Type	Max	Unit	Test PIN
E Cycle Time	t_c	1200	---	---	ns	E
E Rise Time	t_R	---	---	25	ns	E
E Fall Time	t_F	---	---	25	ns	E
E Pulse width (High, Low)	T_{PW}	140	---	---	ns	E
R/W and RS Set-up Time	T_{AS}	0	---	---	ns	R/W,RS
R/W and RS Hold Time	T_{AH}	10	---	---	ns	R/W,RS
Data Output Delay Time	t_{DDR}	---	---	100	ns	DB0~DB7
Data Hold Time	t_H	10	---	---	ns	DB0~DB7

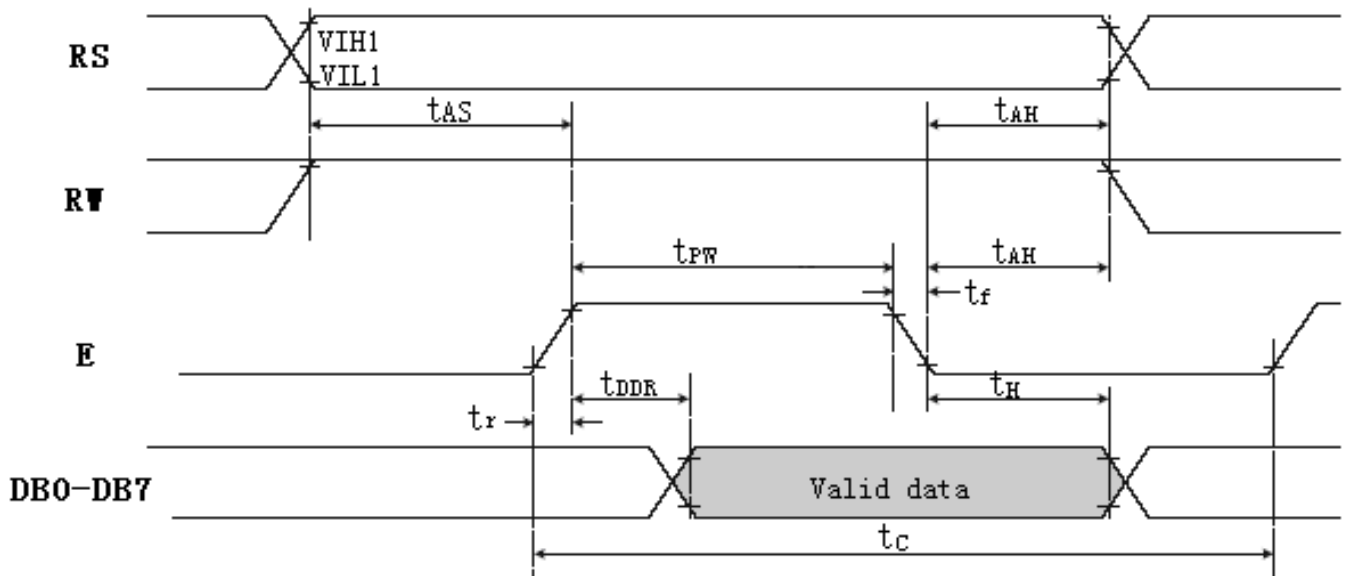

11. CONTROL AND DISPLAY COMMAND

Command	RS	R/W	DB7	DB6	DB5	DB4	DB3	DB2	DB1	DB0	Execution time (fosc=270KHz)	Remark
Clear Display	0	0	0	0	0	0	0	0	0	1	1.52ms	Write"20H" to DDRAM. And set DDRAM address to "00H" from AC
Return home	0	0	0	0	0	0	0	0	1	x	1.52ms	Set DDRAM address to "00H" from AC and return cursor to its original position if shifted. The contents of DDRAM are not changed.
Entry mode Set	0	0	0	0	0	0	0	1	I/D	S	37us	Sets cursor move direction and specifies display shift. These operations are performed during data write and read.
Display on/off control	0	0	0	0	0	0	1	D	C	B	37us	D=1: entire display on C=1: cursor on B=1: cursor position on
Cursor or Display Shift	0	0	0	0	0	1	S/C	R/L	x	x	37us	Set cursor moving and display shift control bit, and the direction, without changing DDRAM data.
function Set	0	0	0	0	1	DL	N	F	x	x	37us	DL: interface data is 8/4 bits N: number of line is 2/1 F: font size is 5x11/5x8
Set CGRAM address	0	0	0	1	AC5	AC4	AC3	AC2	AC1	AC0	37us	Set CGRAM address in address counter
Set DDRAM address	0	0	1	AC6	AC5	AC4	AC3	AC2	AC1	AC0	37us	Set DDRAM address in address counter
Read busy flag& address	0	1	BF	AC6	AC5	AC4	AC3	AC2	AC1	AC0	0us	Whether during internal operation or not can be known by reading BF. The contents of address counter can also be read.
Write data to RAM	1	0	D7	D6	D5	D4	D3	D2	D1	D0	37us	Write data into internal RAM (DDRAM/CGRAM)
Read data from RAM	1	1	D7	D6	D5	D4	D3	D2	D1	D0	37us	Read data from internal RAM (DDRAM / CGRAM)

Note:

Be sure the ST7066U is not in the busy state (BF=00 before sending an instruction from the MPU to the ST7066U. If an instruction is sent without checking the busy flag, the time between the first instruction and next instruction will take much longer than the instruction time itself. Refer to instruction table for the list of each instruction execution time.

12. CHARACTER PATTERN

№. 7066-0T

b7-b4 b3-b0	0000	0001	0010	0011	0100	0101	0110	0111	1000	1001	1010	1011	1100	1101	1110	1111
0000	CG RAM (1)			0	1	2	3	4			5	6	7	8	9	0
0001	(2)	!	1	A	Q	a	q			7	8	9	.	1	2	3
0010	(3)	"	2	B	R	b	r			E	S	e	U	U	U	U
0011	(4)	#	3	C	S	c	s			K	E	k	U	U	U	U
0100	(5)	*	4	D	T	d	t			3	7	ь	7	*	0	0
0101	(6)	%	5	E	U	e	u			K	E	e	X	U	U	U
0110	(7)	&	6	F	V	f	v			K	K	U	7	U	U	U
0111	(8)	'	7	G	W	g	w			U	E	g	U	U	U	U
1000	(1)	()	8	H	X	h	x			U	K	e	U	U	U	U
1001	(2))	9	I	Y	i	y			U	K	e	U	U	U	U
1010	(3)	*	#	J	Z	j	z			0	k	e	U	U	U	U
1011	(4)	+	3	K	C	k	c			4	g	"	W	g	U	U
1100	(5)	.	<	L	*	l	*			U	K	U	U	U	U	U
1101	(6)	-	=	M	I	m	i			b	H	2	W	U	U	U
1110	(7)	.	>	N	^	n	^			U	n	3	7	U	U	U
1111	(8)	/	?	O	_	o	_			3	T	E	"	U	U	U

13. LCD MODULES HANDLING PRECAUTIONS

- Please remove the protection foil of polarizer before using.
- The display panel is made of glass. Do not subject it to a mechanical shock by dropping it from a high place, etc.
- If the display panel is damaged and the liquid crystal substance inside it leaks out, do not get any in your mouth. If the substance come into contact with your skin or clothes promptly wash it off using soap and water.
- Do not apply excessive force to the display surface or the adjoining areas since this may cause the color tone to vary.
- The polarizer covering the display surface of the LCD module is soft and easily scratched. Handle this polarize carefully.
- To prevent destruction of the elements by static electricity, be careful to maintain an optimum work environment.
 - Be sure to ground the body when handling the LCD module.
 - Tools required for assembly, such as soldering irons, must be properly grounded.
 - To reduce the amount of static electricity generated, do not conduct assembly and other work under dry conditions.
 - The LCD module is coated with a film to protect the display surface. Exercise care when peeling off this protective film since static electricity may be generated.
- Storage precautions
When storing the LCD modules, avoid exposure to direct sunlight or to the light of fluorescent lamps. Keep the modules in bags designed to prevent static electricity charging under low temperature / normal humidity conditions (avoid high temperature / high humidity and low temperatures below 0°C). Whenever possible, the LCD modules should be stored in the same conditions in which they were shipped from our company.

14. OTHERS

- Liquid crystals solidify at low temperature (below the storage temperature range) leading to defective orientation of liquid crystal or the generation of air bubbles (black or white). Air bubbles may also be generated if the module is subjected to a strong shock at a low temperature.
- If the LCD modules have been operating for a long time showing the same display patterns may remain on the screen as ghost images and a slight contrast irregularity may also appear. Abnormal operating status can be resumed to be normal condition by suspending use for some time. It should be noted that this phenomena does not adversely affect performance reliability.
- To minimize the performance degradation of the LCD modules resulting from caused by static electricity, etc. exercise care to avoid holding the following sections when handling the modules:
 - Exposed area of the printed circuit board
 - Terminal electrode sections

X-ON Electronics

Largest Supplier of Electrical and Electronic Components

Click to view similar products for [TFT Displays & Accessories](#) category:

Click to view products by [Display Elektronik](#) manufacturer:

Other Similar products are found below :

[OAI-80038AA-2013-A](#) [HDA430T-3G1H](#) [EA CARREDIPTFT02](#) [NL6448BC20-21D](#) [NB7W-KBA04](#) [NB-ATT01](#) [NB5Q-ATT01](#) [NB5Q-KBA04](#) [NB-CN001](#) [NL12880BC20-05](#) [NL8060BC26-35C](#) [NL8060BC26-35F](#) [TCG104SVLQAPNN-AN20](#) [OAI-80038AA-2008-A](#) [315-U004B15300](#) [UMSH-8596MD-34T \(REV D\)](#) [98-0003-3490-8](#) [1044278](#) [1029309](#) [1060549](#) [DE 127-TU-30/7,5](#) [DE 128-TU-20/7,5](#) [EP-LK007TFTPCAP](#) [FR7.0A00](#) [RC2002A-TIG-CSX](#) [NL6448BC2021C](#) [TX17D01VM2EAB](#) [TX14D23VM5BAA](#)
[TCG121WXLRXVNNANX35](#) [EIC-LCD-1080P](#) [T272480C07VR01](#) [1060632](#) [TCG070WVLPAAANN-AN50](#) [TCG035QVLPDANN-GN50](#)
[1060630](#) [RFE430V-AIW-DNG](#) [T-55619GD065J-LW-ABN](#) [NHD-1.8-128160EF-SSXN-FT](#) [TCG104SVLPEANN-AN30](#) [NL6448BC33-70](#)
[NL192108BC18-06F](#) [NLB150XG02L-01](#) [NL6448BC20-30D](#) [NL10276BC16-06](#) [NL192108AC10-01D](#) [NL6448AC18-08F](#) [NL6448BC20-30F](#)
[NL12880BC20-05BD](#) [NL12880BC20-05D](#) [NL8060BC26-35BA](#)