

## Dual 1 Form A Solid State Relay (Low Capacitance)

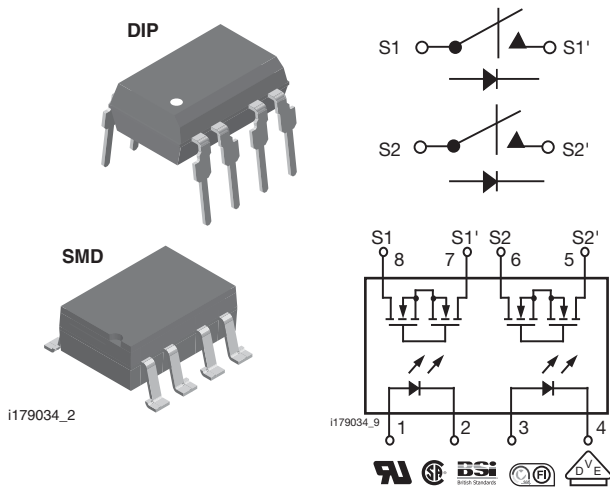

### DESCRIPTION

These dual SSRs (LH1544, dual 1 form A) are SPST normally open switches which can replace electromechanical relays in many applications. The relays provide a low-capacitance, high-voltage switch contact with high off-resistance and low switch-offset voltage. These characteristics, combined with high-speed actuation, result in an SSR which is ideal for small signal and DC instrumentation applications. The relays are constructed by using a GaAlAs LED for actuation control and an integrated monolithic die for the switch output. The die is comprised of a photodiode array, switch-control circuitry, and low-capacitance MOSFET switches.

### FEATURES

- Dual channel, LH1541 type
- Low capacitance switch (5 pF)
- Isolation test voltage 5300 V<sub>RMS</sub>
- Extremely high off-resistance
- Load voltage 200 V
- Clean bounce free switching
- Low power consumption
- High reliability monolithic detector
- Compliant to RoHS Directive 2002/95/EC and in accordance to WEEE 2002/96/EC



**RoHS**  
COMPLIANT

### APPLICATIONS

- Instrumentation
  - Thermocouple switching
  - Analog multiplexing
- Reed relay replacement
- Programmable logic controllers
- Data acquisition
- Test equipment

### AGENCY APPROVALS

- UL1577: file no. E52744 system code H, double protection
- CSA: certification no. 093751
- BSI/BABT: certification no. 7980
- DIN EN: 60747-5-2 (VDE 0884)/60747-5-5 (pending), available with option 1
- FIMKO: approval

ORDERING INFORMATION	
<div style="display: flex; justify-content: space-around; align-items: center;"> <div style="text-align: center;"> <div style="border: 1px solid black; padding: 2px 5px;">L</div> <div style="border: 1px solid black; padding: 2px 5px;">H</div> <div style="border: 1px solid black; padding: 2px 5px;">1</div> <div style="border: 1px solid black; padding: 2px 5px;">5</div> <div style="border: 1px solid black; padding: 2px 5px;">4</div> <div style="border: 1px solid black; padding: 2px 5px;">4</div> </div> <div style="text-align: center;"> <div style="border: 1px solid black; padding: 2px 5px;">A</div> <div style="border: 1px solid black; padding: 2px 5px;">#</div> <div style="border: 1px solid black; padding: 2px 5px;">#</div> </div> <div style="text-align: center;"> <div style="border: 1px solid black; padding: 2px 5px;">T</div> <div style="border: 1px solid black; padding: 2px 5px;">R</div> </div> </div> <p style="text-align: center;">PART NUMBER      ELECTR. VARIATION      PACKAGE CONFIG.      TAPE AND REEL</p> <div style="display: flex; justify-content: space-around; align-items: center;"> </div>	
<b>PACKAGE</b>	<b>UL, CSA, BSI, VDE, FIMKO</b>
SMD-8, tubes	LH1544AAC
SMD-8, tape and reel	LH1544AACTR
DIP-8, tubes	LH1544AB

# LH1544AAC, LH1544AACTR, LH1544AB



Vishay Semiconductors Dual 1 Form A Solid State Relay  
(Low Capacitance)

ABSOLUTE MAXIMUM RATINGS ( $T_{amb} = 25\text{ }^{\circ}\text{C}$ , unless otherwise specified)				
PARAMETER	TEST CONDITION	SYMBOL	VALUE	UNIT
<b>INPUT</b>				
LED continuous forward current		$I_F$	50	mA
LED reverse voltage	$I_R \leq 10\text{ }\mu\text{A}$	$V_R$	8	V
<b>OUTPUT</b>				
DC or peak AC load voltage	$I_L \leq 50\text{ }\mu\text{A}$	$V_L$	200	V
Continuous DC load current, one pole operating		$I_L$	55	mA
Continuous DC load current, two poles operating		$I_L$	40	mA
<b>SSR</b>				
Peak load current (single shot)	$t = 100\text{ ms}$	$I_P$	100	mA
Ambient temperature range		$T_{amb}$	- 40 to + 85	$^{\circ}\text{C}$
Storage temperature range		$T_{stg}$	- 40 to + 150	$^{\circ}\text{C}$
Pin soldering temperature <sup>(1)</sup>	$t = 10\text{ s max.}$	$T_{sid}$	260	$^{\circ}\text{C}$
Input to output isolation voltage		$V_{ISO}$	5300	$V_{RMS}$
Pole-to-pole isolation voltage (S1 to S2) <sup>(2)</sup>	dry air, dust free, at sea level		1600	V
Output power dissipation (continuous)		$P_{diss}$	600	mW

## Notes

- Stresses in excess of the absolute maximum ratings can cause permanent damage to the device. Functional operation of the device is not implied at these or any other conditions in excess of those given in the operational sections of this document. Exposure to absolute maximum ratings for extended periods of the time can adversely affect reliability.
- <sup>(1)</sup> Refer to reflow profile for soldering conditions for surface mounted devices (SMD). Refer to wave profile for soldering conditions for through hole devices (DIP).
- <sup>(2)</sup> Breakdown occurs between the output pins external to the package.

ELECTRICAL CHARACTERISTICS ( $T_{amb} = 25\text{ }^{\circ}\text{C}$ , unless otherwise specified)						
PARAMETER	TEST CONDITION	SYMBOL	MIN.	TYP.	MAX.	UNIT
<b>INPUT</b>						
LED forward current, switch turn-on	$I_L = 100\text{ mA}$ , $t = 10\text{ ms}$	$I_{Fon}$		0.9	2	mA
LED forward current, switch turn-off	$V_L = \pm 150\text{ V}$	$I_{Foff}$	0.2	0.8		mA
LED forward voltage	$I_F = 5\text{ mA}$	$V_F$	1.1	1.19	1.45	V
<b>OUTPUT</b>						
On-resistance	$I_F = 5\text{ mA}$ , $I_L = 50\text{ mA}$	$R_{ON}$	70	110	160	$\Omega$
Off-resistance	$I_F = 0\text{ mA}$ , $V_L = \pm 100\text{ V}$	$R_{OFF}$	0.5	10 000		$G\Omega$
Off-state leakage current	$I_F = 0\text{ mA}$ , $V_L = \pm 100\text{ V}$	$I_O$		0.01	200	nA
	$I_F = 0\text{ mA}$ , $V_L = \pm 200\text{ V}$	$I_O$			1	$\mu\text{A}$
Output capacitance	$I_F = 0\text{ mA}$ , $V_L = 1\text{ V}$	$C_O$		0		pF
Output capacitance pin 4 to 6	$I_F = 0\text{ mA}$ , $V_L = 50\text{ V}$	$C_O$		0.5		pF
Pole-to-pole Capacitance (S1 to S2)	$I_F = 5\text{ mA}$			0.5		pF
Switch offset	$I_F = 5\text{ mA}$	$V_{OS}$		0.1		$\mu\text{V}$
<b>TRANSFER</b>						
Capacitance (input to output)	$V_{ISO} = 1\text{ V}$	$C_{IO}$		1.1		pF

## Note

- Minimum and maximum values are testing requirements. Typical values are characteristics of the device and are the result of engineering evaluations. Typical values are for information only and are not part of the testing requirements.

SWITCHING CHARACTERISTICS ( $T_{amb} = 25\text{ }^{\circ}\text{C}$ , unless otherwise specified)						
PARAMETER	TEST CONDITION	SYMBOL	MIN.	TYP.	MAX.	UNIT
Turn-on time	$I_F = 5\text{ mA}$ , $I_L = 50\text{ mA}$	$t_{on}$		0.24	0.5	ms
Turn-off time	$I_F = 5\text{ mA}$ , $I_L = 50\text{ mA}$	$t_{off}$		0.13	0.5	ms

## Footnotes

The following information refers to the SSR recommended operation conditions:

- Both relays on with equal load currents. For single relay operation, refer to the LH1541 recommended operating conditions graph.



# LH1544AAC, LH1544AACTR, LH1544AB

Dual 1 Form A Solid State Relay    Vishay Semiconductors  
(Low Capacitance)

## TYPICAL CHARACTERISTICS ( $T_{amb} = 25\text{ }^{\circ}\text{C}$ , unless otherwise specified)

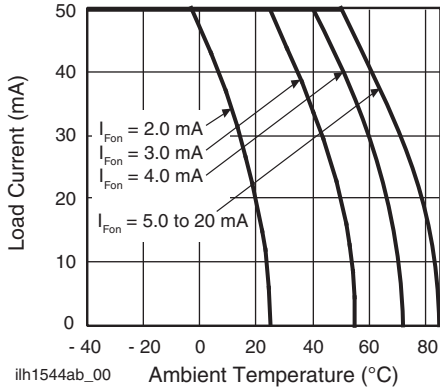

Fig. 1 - Recommended Operating Conditions

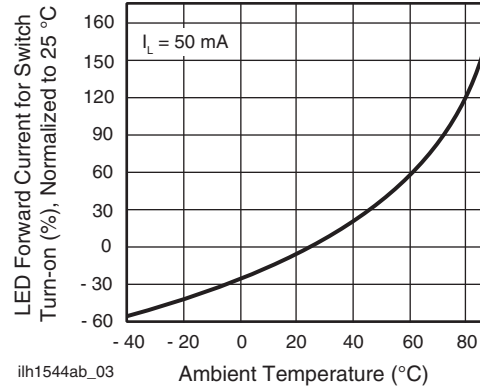

Fig. 4 - LED Current for Switch Turn-on vs. Temperature

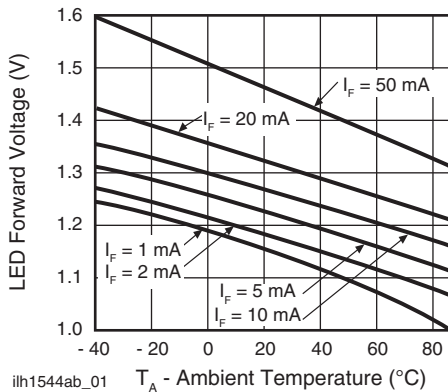

Fig. 2 - LED Voltage vs. Temperature

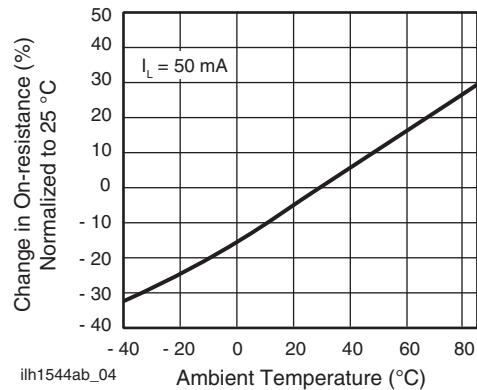

Fig. 5 - On-Resistance vs. Temperature

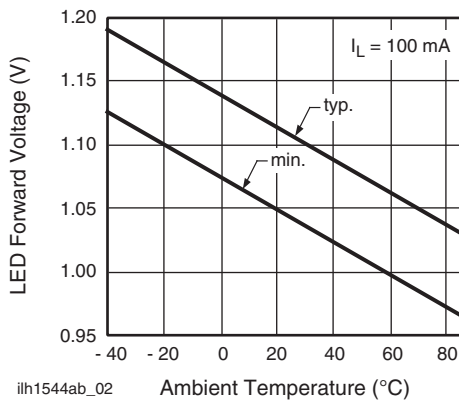

Fig. 3 - LED Dropout Voltage vs. Temperature

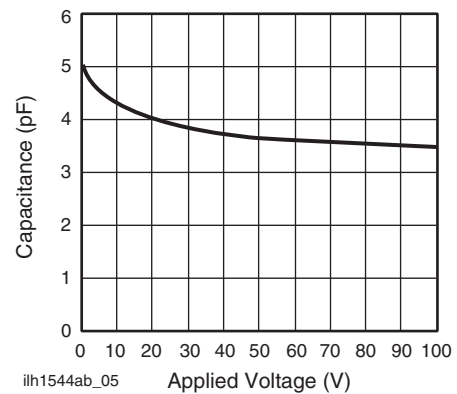

Fig. 6 - Switch Capacitance vs. Applied Voltage

# LH1544AAC, LH1544AACTR, LH1544AB



Vishay Semiconductors Dual 1 Form A Solid State Relay  
(Low Capacitance)

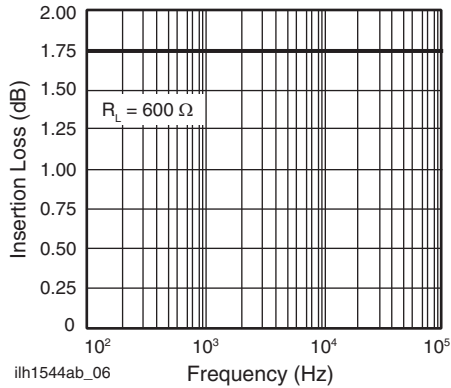

Fig. 7 - Insertion Loss vs. Frequency

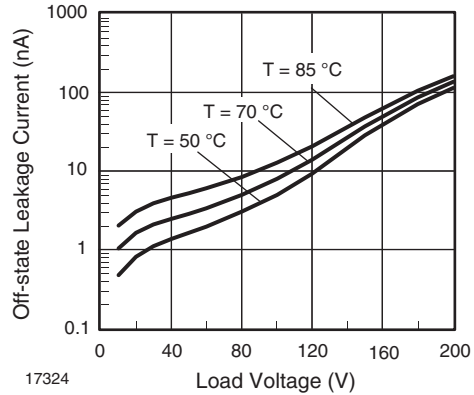

Fig. 10 - Leakage Current vs. Applied Voltage at Elevated Temperatures

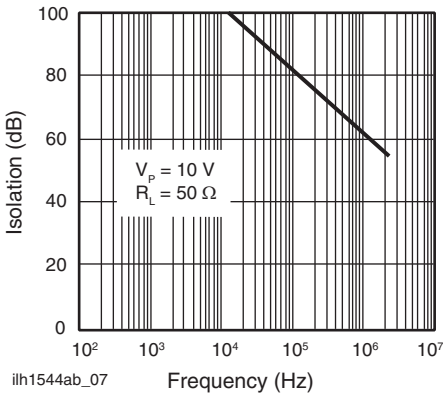

Fig. 8 - Output Isolation

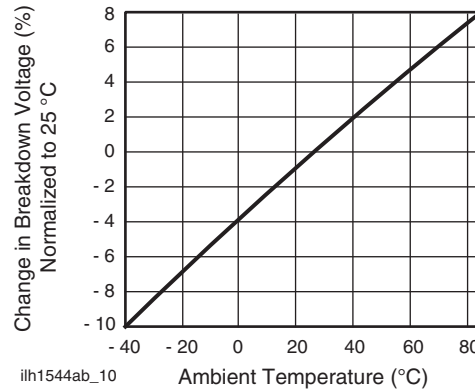

Fig. 11 - Switch Breakdown Voltage vs. Temperature

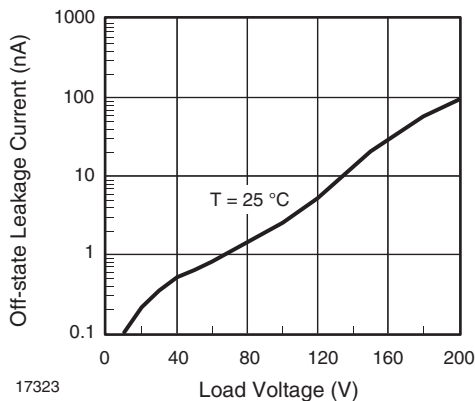

Fig. 9 - Leakage Current vs. Applied Voltage

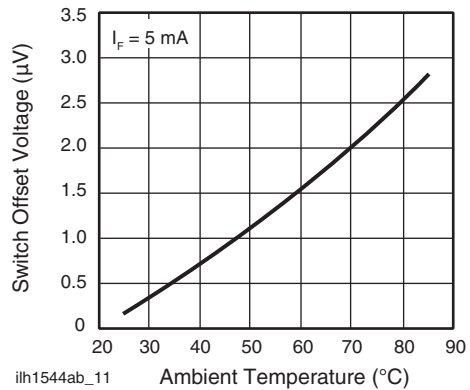

Fig. 12 - Switch Offset Voltage vs. Temperature



# LH1544AAC, LH1544AACTR, LH1544AB

Dual 1 Form A Solid State Relay Vishay Semiconductors  
(Low Capacitance)

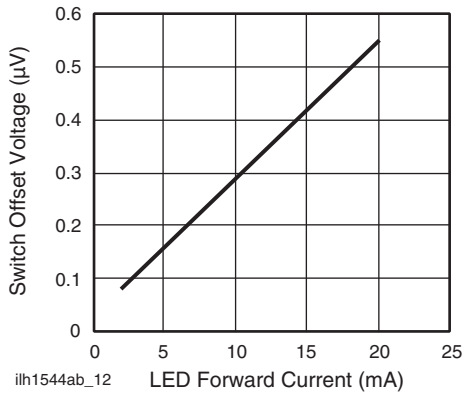

Fig. 13 - Switch Offset Voltage vs. LED Current

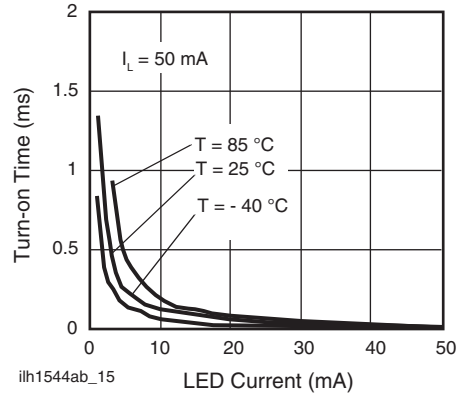

Fig. 16 - Turn-on Time vs. LED Current

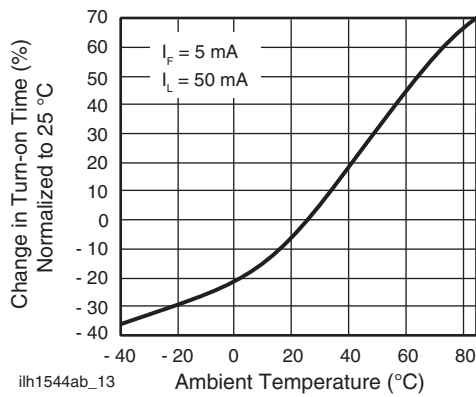

Fig. 14 - Turn-on Time vs. Temperature

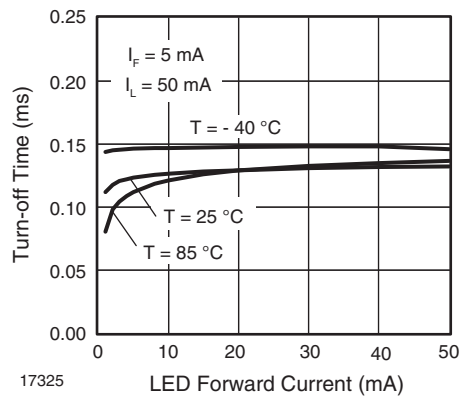

Fig. 17 - Turn-off Time vs. LED Current

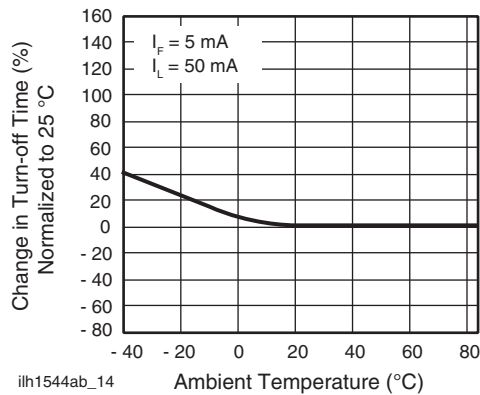

Fig. 15 - Turn-off Time vs. Temperature

# LH1544AAC, LH1544AACTR, LH1544AB



Vishay Semiconductors Dual 1 Form A Solid State Relay  
(Low Capacitance)

## PACKAGE DIMENSIONS in millimeters

DIP

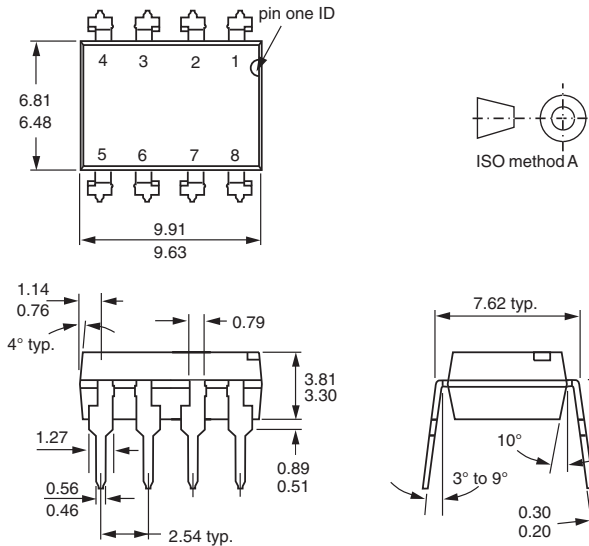

i178008

SMD

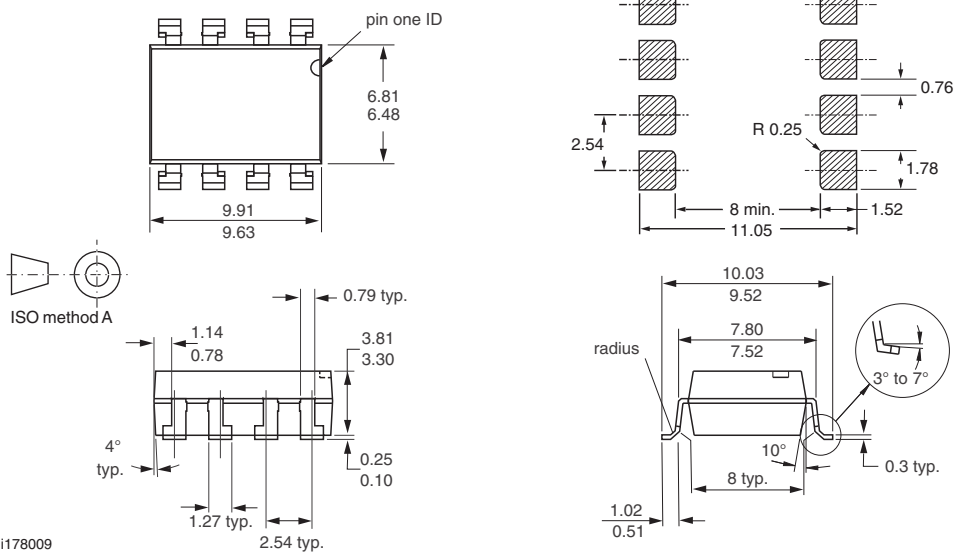

i178009

## PACKAGE MARKING (example)

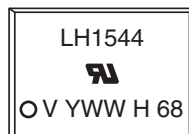

### Note

- Tape and reel suffix (TR) is not part of the package marking.



## Footprint and Schematic Information for LH1544AAC, LH1544ACTR, LH1544AB

The footprint and schematic symbols for the following parts can be accessed using the associated links. They are available in Eagle, Altium, KiCad, OrCAD / Allegro, Pulsonix, and PADS.

Note that the 3D models for these parts can be found on the Vishay product page.

PART NUMBER	FOOTPRINT / SCHEMATIC
LH1544AAC	<a href="http://www.snapeda.com/parts/LH1544AAC/Vishay/view-part">www.snapeda.com/parts/LH1544AAC/Vishay/view-part</a>
LH1544ACTR	<a href="http://www.snapeda.com/parts/LH1544ACTR/Vishay/view-part">www.snapeda.com/parts/LH1544ACTR/Vishay/view-part</a>
LH1544AB	<a href="http://www.snapeda.com/parts/LH1544AB/Vishay/view-part">www.snapeda.com/parts/LH1544AB/Vishay/view-part</a>

For technical issues and product support, please contact [optocoupleranswers@vishay.com](mailto:optocoupleranswers@vishay.com).

DIP

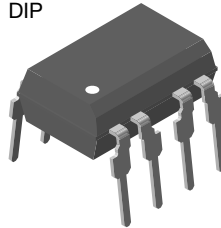

SMD

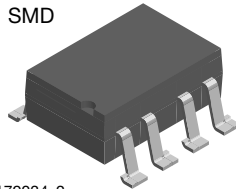

i179034\_2



## **Disclaimer**

ALL PRODUCT, PRODUCT SPECIFICATIONS AND DATA ARE SUBJECT TO CHANGE WITHOUT NOTICE TO IMPROVE RELIABILITY, FUNCTION OR DESIGN OR OTHERWISE.

Vishay Intertechnology, Inc., its affiliates, agents, and employees, and all persons acting on its or their behalf (collectively, "Vishay"), disclaim any and all liability for any errors, inaccuracies or incompleteness contained in any datasheet or in any other disclosure relating to any product.

Vishay makes no warranty, representation or guarantee regarding the suitability of the products for any particular purpose or the continuing production of any product. To the maximum extent permitted by applicable law, Vishay disclaims (i) any and all liability arising out of the application or use of any product, (ii) any and all liability, including without limitation special, consequential or incidental damages, and (iii) any and all implied warranties, including warranties of fitness for particular purpose, non-infringement and merchantability.

Statements regarding the suitability of products for certain types of applications are based on Vishay's knowledge of typical requirements that are often placed on Vishay products in generic applications. Such statements are not binding statements about the suitability of products for a particular application. It is the customer's responsibility to validate that a particular product with the properties described in the product specification is suitable for use in a particular application. Parameters provided in datasheets and / or specifications may vary in different applications and performance may vary over time. All operating parameters, including typical parameters, must be validated for each customer application by the customer's technical experts. Product specifications do not expand or otherwise modify Vishay's terms and conditions of purchase, including but not limited to the warranty expressed therein.

Except as expressly indicated in writing, Vishay products are not designed for use in medical, life-saving, or life-sustaining applications or for any other application in which the failure of the Vishay product could result in personal injury or death. Customers using or selling Vishay products not expressly indicated for use in such applications do so at their own risk. Please contact authorized Vishay personnel to obtain written terms and conditions regarding products designed for such applications.

No license, express or implied, by estoppel or otherwise, to any intellectual property rights is granted by this document or by any conduct of Vishay. Product names and markings noted herein may be trademarks of their respective owners.



## X-ON Electronics

Largest Supplier of Electrical and Electronic Components

*Click to view similar products for [Solid State Relays - PCB Mount](#) category:*

*Click to view products by [Vishay](#) manufacturer:*

Other Similar products are found below :

[M90F-2W](#) [G2-1A07-ST](#) [G2-1A07-TT](#) [G2-1B02-TT](#) [G2-DA06-ST](#) [G3CN-202PL-3-US DC12](#) [G3CN-203P DC3-28](#) [G3RDX02SNUSDC12](#)  
[PLA134S](#) [DMP6202A](#) [DS11-1005](#) [AQ3A2-ZT432VDC](#) [AQV212J](#) [AQV214SD02](#) [AQV252GAJ](#) [AQY212SXT](#) [AQY221R2SJ](#)  
[EFR1200480A150](#) [LCA220](#) [LCB110S](#) [1618400-5](#) [SR75-1ST](#) [AQV212AJ](#) [AQV238AD01](#) [AQV252GAXJ](#) [AQW414TS](#) [AQY210SXT](#)  
[AQY212ST](#) [AQY221N2V1YJ](#) [AQY275AXJ](#) [G2-1A02-ST](#) [G2-1A02-TT](#) [G2-1A03-ST](#) [G2-1A03-TT](#) [G2-1A05-ST](#) [G2-1A06-TT](#) [G2-1A23-](#)  
[TT](#) [G2-1B01-ST](#) [G2-1B01-TT](#) [G2-1B02-ST](#) [G2-DA03-ST](#) [G2-DA03-TT](#) [G2-DA06-TT](#) [G3M-203PL-UTU-1 DC24](#) [CPC2330N](#) [3-1617776-](#)  
[2](#) [CTA2425](#) [TS190](#) [LBB110S](#) [LCB126S](#)