

5mm Round With Flange Type

Infrared LED

Technical Data Sheet

Part No.: 503HIRT2E-1CC



## Features:

- Standard T-1 3/4 diameter package.
- Low forward voltage.
- Infrared Emitting Diode.
- Viewing angle =20°.
- Reliable and rugged.
- The product itself will remain within RoHS complaint Version.

## Descriptions:

The device is spectrally matched with silicon photodiode and phototransistor.

## Applications:

- Floppy disk drive.
- Optoelectronic switch.
- Camera.
- VCR.
- Video.
- Smoke detector.
- Infrared applied system.
- Free air transmission system.
- Infrared remote control units.

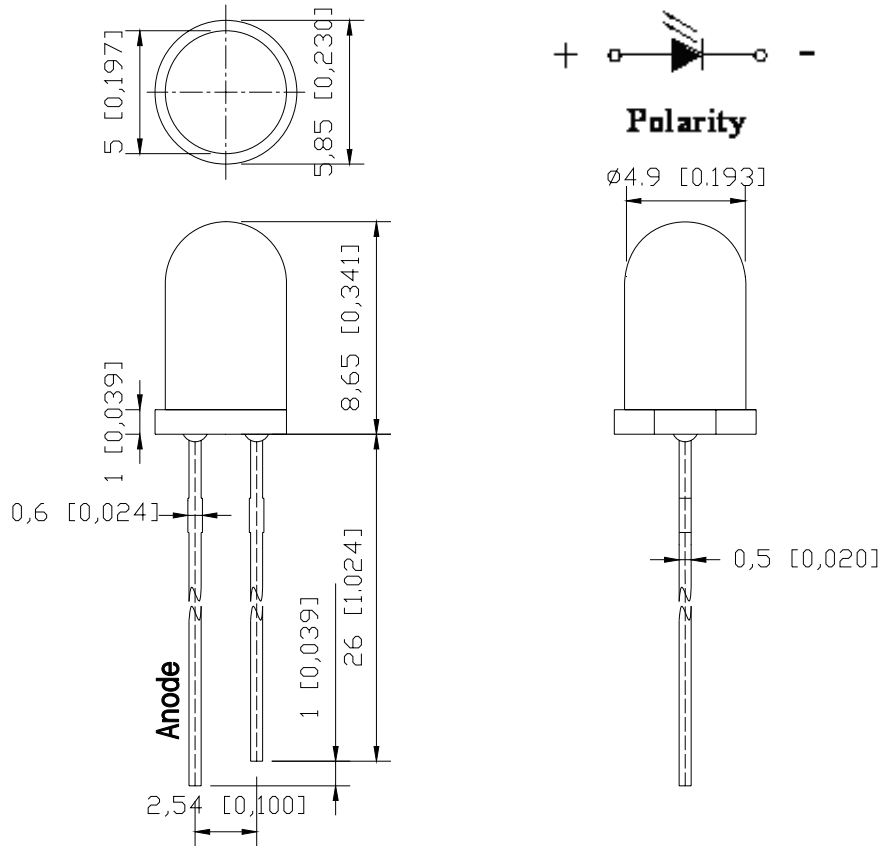
**Package Dimension:**

Part No.	Material	Lens Color	Source Color
503HIRT2E-1CC	GaAlAs	Blue Transparent	Infrared

**Notes:**

1. All dimensions are in millimeters (inches).
2. Tolerance is  $\pm 0.25$  (.010" ) unless otherwise specified.
3. Protruded resin under flange is 1.00mm (.039" ) max.
4. Specifications are subject to change without notice.

**Absolute Maximum Ratings at Ta=25**

Parameters	Symbol	Max.	Unit
Power Dissipation	PD	160	mW
Peak Forward Current (1/10 Duty Cycle, 0.1ms Pulse Width)	IFP	100	mA
Forward Current	IF	100	mA
Reverse Voltage	VR	5	V
Electrostatic Discharge (HBM)	ESD	2000	V
Operating Temperature Range	Topr	-40 to +85	
Storage Temperature Range	Tstg	-40 to +100	
Soldering Temperature	Tsld	260 for 5 Seconds	

**Electrical Optical Characteristics at Ta=25**

Parameters	Symbol	Min.	Typ.	Max.	Unit	Test Condition
Radiant Intensity	Ee	10	15	---	mW/sr	IF =20mA
Viewing Angle*	2θ <sub>1/2</sub>	---	20	---	Deg	(Note 1)
Peak Emission Wavelength	λ <sub>p</sub>	---	880	---	nm	IF=20mA
Spectral Bandwidth	λ	---	45	---	nm	IF=20mA
Forward Voltage	VF	1.00	1.30	1.60	V	IF =20mA
Reverse Current	IR	---	---	10	μA	VR=5V

**Notes:**

1. θ<sub>1/2</sub> is the off-axis angle at which the luminous intensity is half the axial luminous intensity.

Typical Electrical / Optical Characteristics Curves  
(25 Ambient Temperature Unless Otherwise Noted)

Fig.1 Forward Current vs. Ambient Temperature

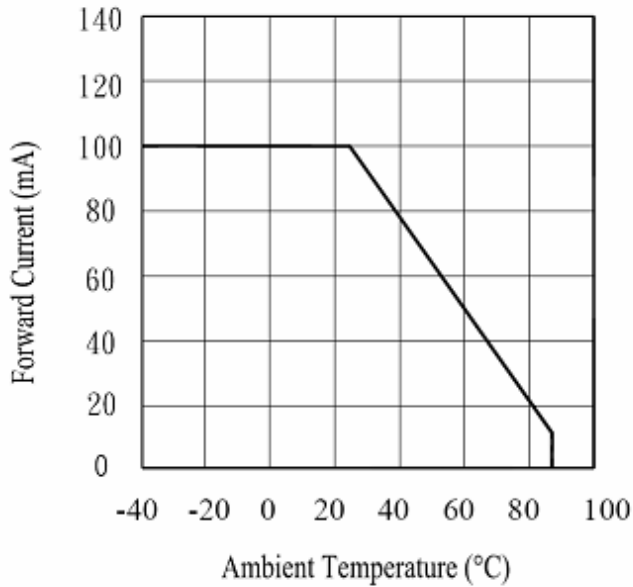

Fig.2 Spectral Distribution

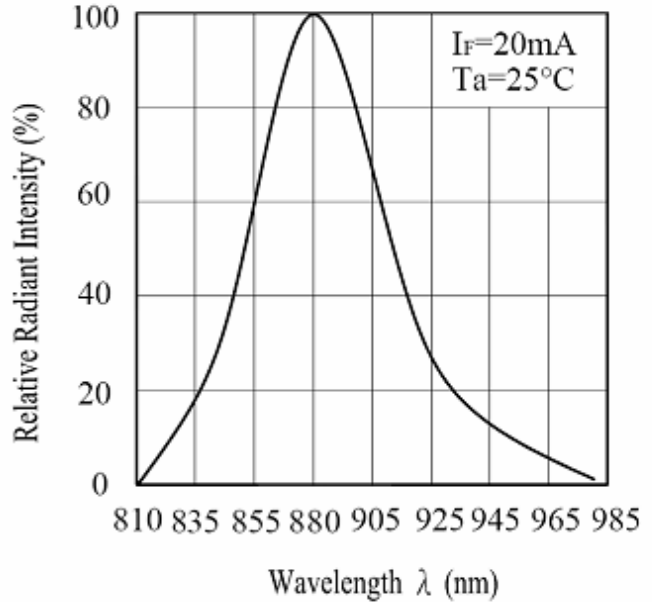

Fig.3 Peak Emission Wavelength vs. Ambient Temperature

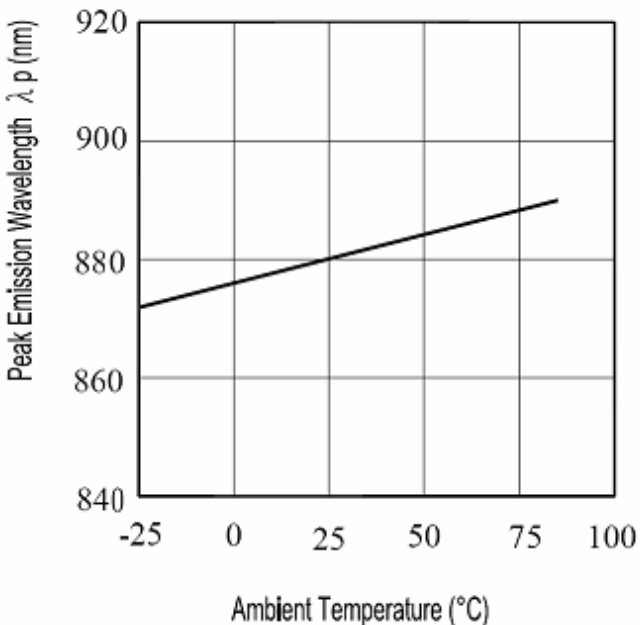

Fig.4 Forward Current vs. Forward Voltage

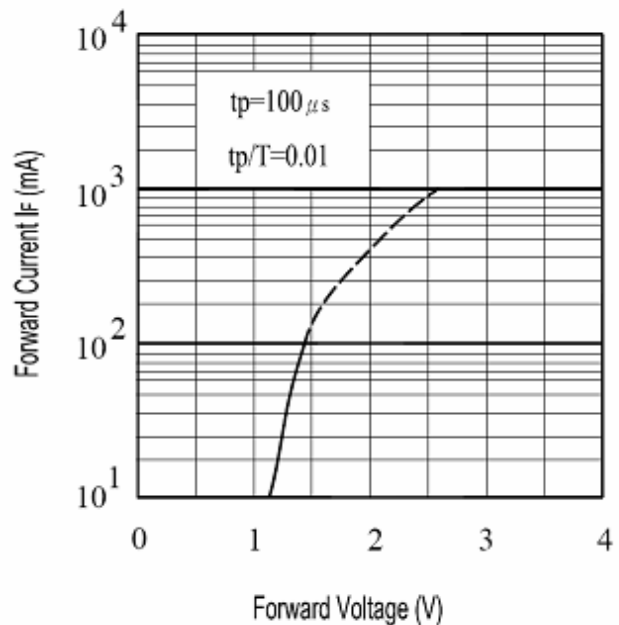

Fig.5 Relative Intensity vs.  
Forward Current

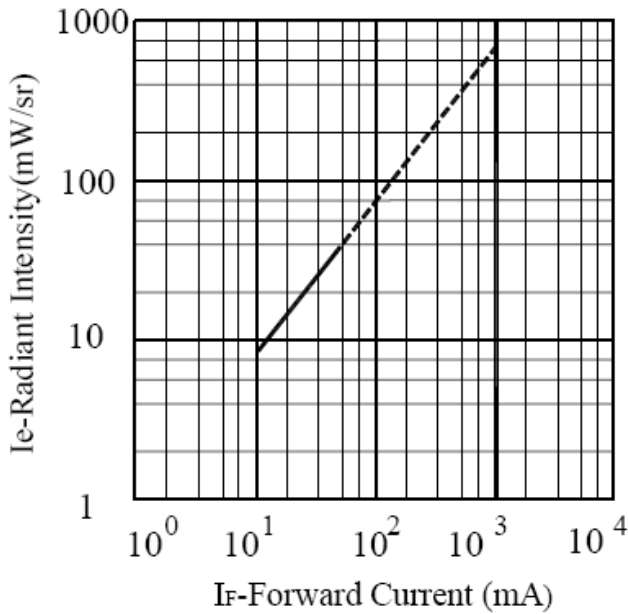

Fig.6 Relative Radiant Intensity vs.  
Angular Displacement

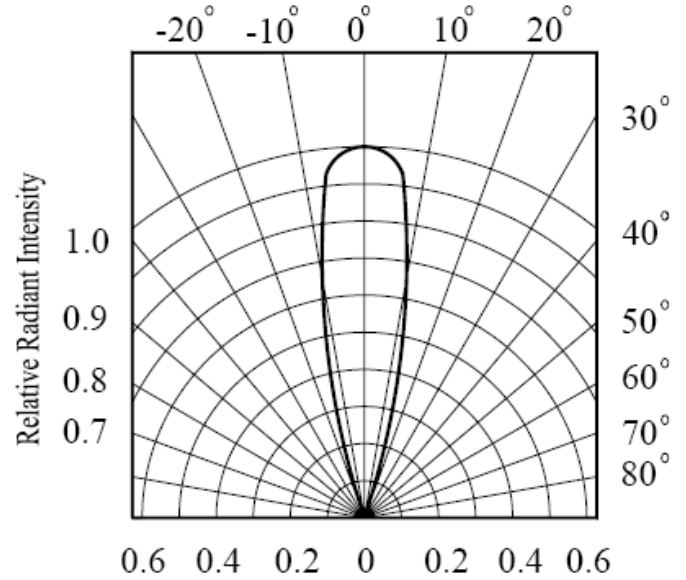

Fig.7 Relative Intensity vs.  
Ambient Temperature(°C)

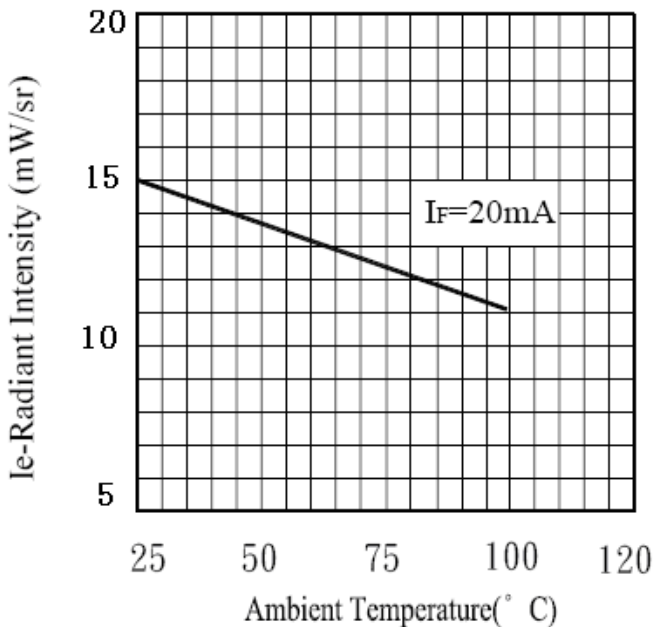
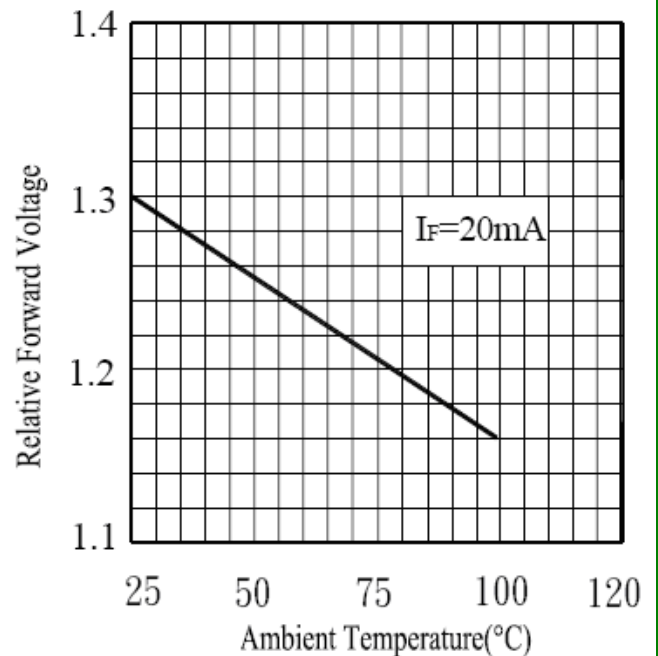

Fig.8 Forward Voltage vs.  
Ambient Temperature(°C)



## Reliability Test Items And Conditions:

The reliability of products shall be satisfied with items listed below:

Confidence level: 90%.

LTPD: 10%.

### 1) Test Items and Results:

No.	Item	Test Conditions	Test Hours/ Cycles	Sample Sizes	Failure Judgment Criteria	Ac/ Re
1	Reflow Soldering	TEMP.: 260 $\pm$ 5 5secs	6mins	22pcs	IR U $\times$ 2 Ee L $\times$ 0.8 VF U $\times$ 1.2  U: Upper Specification Limit L: Lower Specification Limit	0/1
2	Temperature Cycle	H: +100 15mins ┆ 5 mins ┆ L: -40 15mins	50Cycles	22pcs		0/1
3	Thermal Shock	H: +100 15mins ┆ 10mins ┆ L: -10 5mins	50Cycles	22pcs		0/1
4	High Temperature Storage	TEMP.: +100	1000hrs	22pcs		0/1
5	Lower Temperature Storage	TEMP.: -40	1000hrs	22pcs		0/1
6	DC Operating Life	V <sub>CE</sub> =5V	1000hrs	22pcs		0/1
7	High Temperature/ High Humidity	85 / 85% R.H	1000hrs	22pcs		0/1

### 2) Criteria for Judging The Damage:

Item	Symbol	Test Conditions	Criteria for Judgment	
			Min	Max
Forward Voltage	VF	IF = 20mA	—	F.V.*) $\times$ 1.1
Reverse Current	IR	VR=5V	—	F.V.*) $\times$ 2.0

\*) F.V.: First Value.

Please read the following notes before using the product:

1. Over-current-proof

Customer must apply resistors for protection, otherwise slight voltage shift will cause big current change (Burn out will happen).

2. Storage

- 2.1 Do not open moisture proof bag before the products are ready to use.
- 2.2 Before opening the package, the LEDs should be kept at 30 °C or less and 80%RH or less.
- 2.3 The LEDs should be used within a year.
- 2.4 After opening the package, the LEDs should be kept at 30 °C or less and 60%RH or less.
- 2.5 The LEDs should be used within 168 hours (7 days) after opening the package.

3. Soldering Iron

Each terminal is to go to the tip of soldering iron temperature less than 260 °C for 5 seconds within once in less than the soldering iron capacity 25W. Leave two seconds and more intervals, and do soldering of each terminal. Be careful because the damage of the product is often started at the time of the hand solder.

4. Soldering

When soldering, for Lamp without stopper type and must be leave a minimum of 3mm clearance from the base of the lens to the soldering point.  
 To avoided the Epoxy climb up on lead frame and was impact to non-soldering problem, dipping the lens into the solder must be avoided.  
 Do not apply any external stress to the lead frame during soldering while the LED is at high temperature.

Recommended soldering conditions:

Soldering Iron		Wave Soldering	
Temperature	300 Max.	Pre-heat	100 Max.
Soldering Time	3 sec. Max. (one time only)	Pre-heat Time	60 sec. Max.
		Solder Wave	260 Max.
		Soldering Time	5 sec. Max.

Note: Excessive soldering temperature and / or time might result in deformation of the LED lens or catastrophic failure of the LED.

5. Repairing

Repair should not be done after the LEDs have been soldered. When repairing is unavoidable, a double-head soldering iron should be used (as below figure). It should be confirmed beforehand whether the characteristics of the LEDs will or will not be damaged by repairing.

6. Caution in ESD

Static Electricity and surge damages the LED. It is recommended to use a wrist band or anti-electrostatic glove when handling the LED. All devices equipment and machinery must be properly grounded.



## X-ON Electronics

Largest Supplier of Electrical and Electronic Components

*Click to view similar products for [Infrared Emitters - High Power](#) category:*

*Click to view products by [Lucky Light](#) manufacturer:*

Other Similar products are found below :

[IR19-315C/TR8](#) [SFH 4030](#) [SFH 4060](#) [HSM8-V380](#) [HSM9-V380](#) [SFH 5750](#) [PK2S-2KJE-A](#) [PK2S-2LJE-A](#) [PK2S-3KJE-A](#) [PK2S-3KKE-A](#)  
[PK2S-3LJE-A](#) [PK2S-4KJE-A](#) [AREQ-90C0-00000](#) [AREQ-80C0-00000](#) [SFH 4775S A01](#) [SST-10-IRD-B90H-S810](#) [SFH 4727A](#) [SFH 4726AS](#)  
[SFH 4717AS](#) [AREQ-8020-00000](#) [HR5P-N3FB-00000](#) [HR5P-N2FB-00000](#) [HR5P-N3CB-00000](#) [HR5P-N2CB-00000](#) [HR5P-N3CA-00000](#)  
[HR5P-N2CA-00000](#) [HR5P-N2FA-00000](#) [HR5P-N3FA-00000](#) [VSMY2853SLX01](#) [VSMY2853RGX01](#) [VSMY2853GX01](#) [VSMY2850GX01](#)  
[IN-P281ASGHIR](#) [IN-P281ASGIR](#) [QEE123](#) [HSDL-4400#011](#) [C3535SIR2C-2B](#) [KM-4457F3C](#) [L-53F3BT](#) [VTE1291W-2H](#) [LL-304IRC4B-](#)  
[2AD](#) [LL-503HIRT2E-1CC](#) [LL-503IRC2E-2AC](#) [LL-503IRC2V-2AD](#) [LL-503IRT2E-2AC](#) [LL-503IRT2E-2AE](#) [LL-503SIRC2E-1BD](#) [LL-](#)  
[503SIRC2H-1BE](#) [LL-S170IRC-2A](#) [SFH 4259](#)