



Lucky Light

1.50mm Height PLCC-6 Package Top View Type
Hyper Red Chip LED
Technical Data Sheet

Part No.: R5050VC-V1-4H

Features:

- ◇ PLCC-6 package.
- ◇ White package.
- ◇ Optical indicator.
- ◇ Colorless clear window.
- ◇ Ideal for backlight and light pipe application.
- ◇ Inter reflector.
- ◇ Built in 3 LED chips.
- ◇ Wide viewing angle.
- ◇ Suitable for vapor-phase reflow, infrared reflow and wave solder processes.
- ◇ Suitable for all SMT assembly and solder process.
- ◇ Computable with automatic placement equipment.
- ◇ Available on tape and reel (12mm Tape).
- ◇ The product itself will remain within RoHS compliant Version.

Descriptions:

- ◇ The R5050 is available in soft red, orange, yellow, green, blue and white. Due to the Package design, the LED has wide viewing angle and optimized light coupling by inter reflector, this feature makes the SMT TOP LED ideal for light pipe Application. The low current requirement makes this device ideal for portable equipment or any other application where power is at a premium.

Applications:

- ◇ Automotive: Backlight in dashboards and switches.
- ◇ Telecommunication: Indicator and backlight in telephone and fax.
- ◇ Indicator and backlight for audio and video equipment.
- ◇ Indicator and backlight in office and family equipment.
- ◇ Flat backlight for LCD's, switches and symbols.
- ◇ Light pipe application.
- ◇ General use.

Package Dimension:

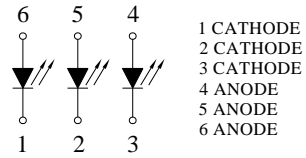
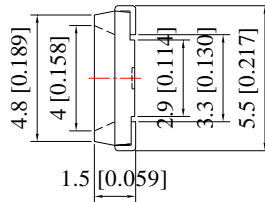
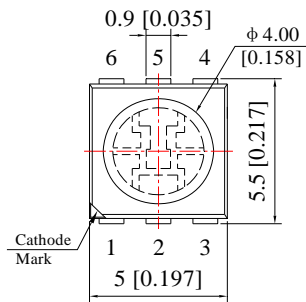

Polarity

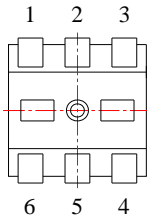
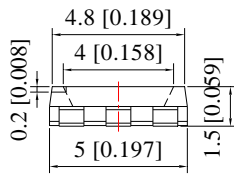

Recommended Soldering Pad dimensions

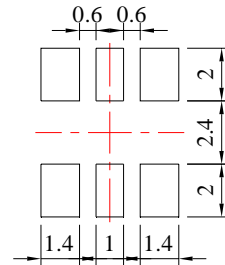

Unit: mm
Tolerance: $\pm 0.10\text{mm}$

Part No.	Chip Material	Lens Color	Source Color
R5050VC-V1-4H	AlGaInP	Water Clear	Hyper Red

Notes:

1. All dimensions are in millimeters (inches).
2. Tolerance is $\pm 0.25\text{mm}$ (.010") unless otherwise specified.
3. Specifications are subject to change without notice.

Absolute Maximum Ratings at Ta=25°C

Parameters	Symbol	Max.	Unit
Power Dissipation	PD	60x3	mW
Peak Forward Current (1/10 Duty Cycle, 0.1ms Pulse Width)	IFP	100x3	mA
Continuous Forward Current	IF	25x3	mA
Reverse Voltage	VR	5	V
Electrostatic Discharge (HBM)	ESD	2000	V
Operating Temperature Range	Topr	-40°C to +80°C	
Storage Temperature Range	Tstg	-40°C to +85°C	
Soldering Temperature	Tsld	260°C for 5 Seconds	

Electrical Optical Characteristics at Ta=25°C

Parameters	Symbol	Min.	Typ.	Max.	Unit	Test Condition
Luminous Intensity	IV	1200	1600	---	mcd	IF=20mA×3=60mA (Note 1)
Viewing Angle	2θ _{1/2}	---	120	---	Deg	IF=20mA×3=60mA (Note 2)
Peak Emission Wavelength	λ _p	---	632	---	nm	IF=20mA×3=60mA
Dominant Wavelength	λ _d	---	624	---	nm	IF=20mA×3=60mA (Note 3)
Spectral Line Half-Width	Δλ	---	20	---	nm	IF=20mA×3=60mA
Forward Voltage	VF	1.60	2.00	2.40	V	IF=20mA×3=60mA
Reverse Current	IR	---	---	10	μA	V _R =5V

Notes:

- Luminous Intensity Measurement allowance is ± 10%.
- θ_{1/2} is the off-axis angle at which the luminous intensity is half the axial luminous intensity.
- The dominant wavelength (λ_d) is derived from the CIE chromaticity diagram and represents the single wavelength which defines the color of the device.

Typical Electrical / Optical Characteristics Curves (Per Chip)
 (25°C Ambient Temperature Unless Otherwise Noted)

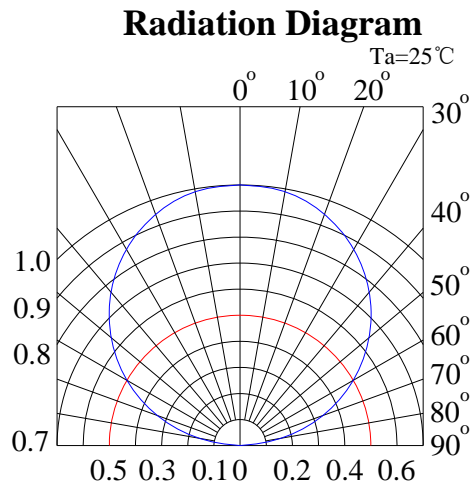
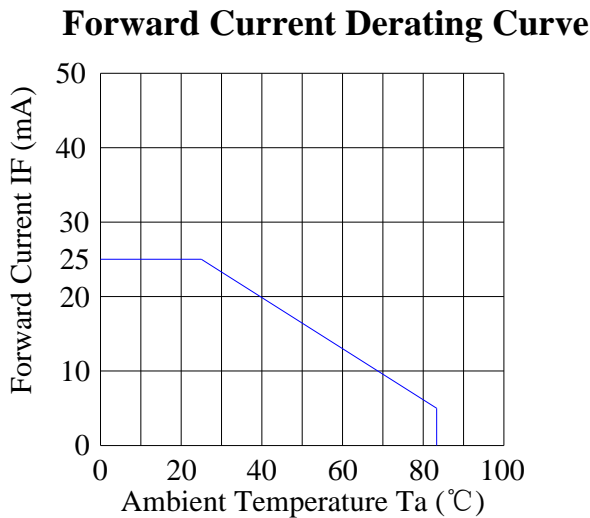
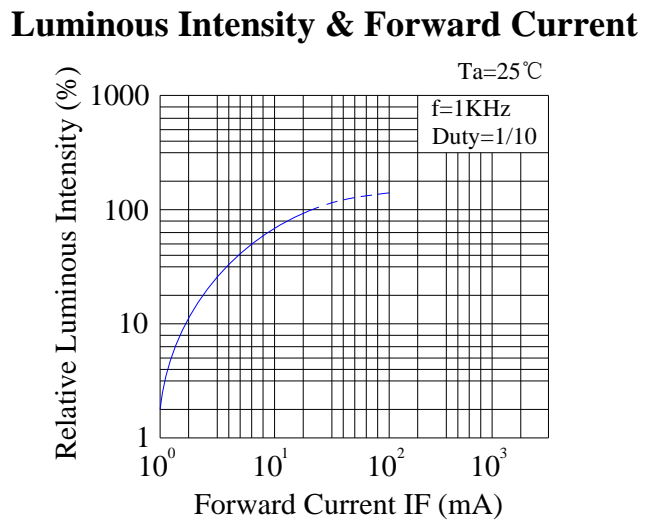
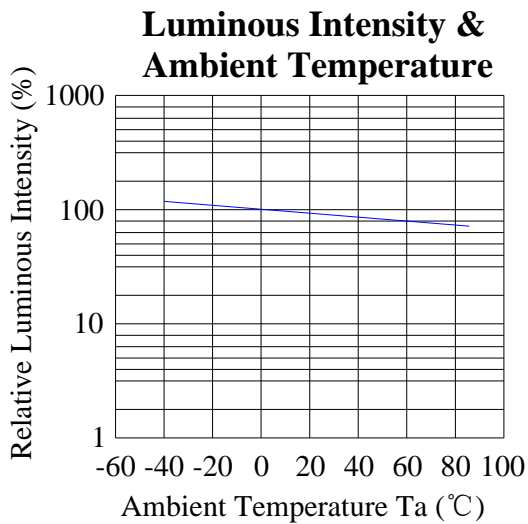
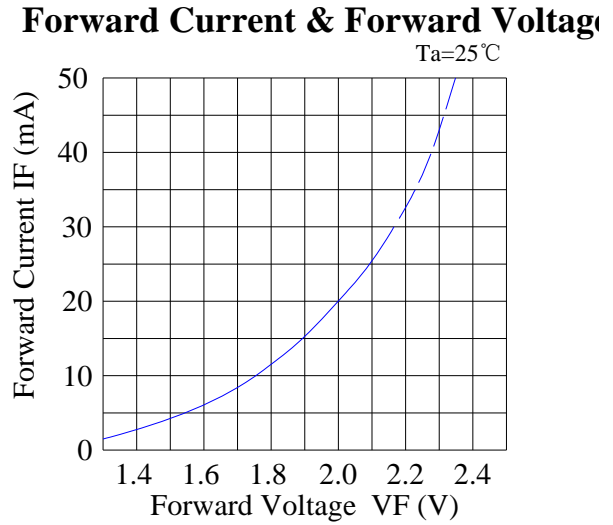
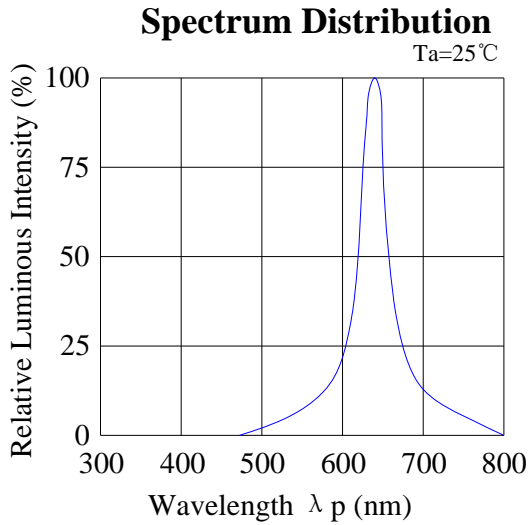

Reliability Test Items And Conditions:

The reliability of products shall be satisfied with items listed below:

Confidence level: 90%.

LTPD: 10%.

1) Test Items and Results:

No.	Test Item	Test Hours/Cycles	Test Conditions	Sample Size	Ac/Re
1	Resistance to Soldering Heat	6 Min	Tsld=260±5°C, Min. 5sec	25pcs	0/1
2	Thermal Shock	300 Cycles	H: +100°C 5min ∫ 10 sec L: -10°C 5min	25pcs	0/1
3	Temperature Cycle	300 Cycles	H: +100°C 15min ∫ 5min L: -40°C 15min	25pcs	0/1
4	High Temperature Storage	1000Hrs.	Temp: 100°C	25pcs	0/1
5	DC Operating Life	1000Hrs.	IF=60mA	25pcs	0/1
6	Low Temperature Storage	1000Hrs.	Temp: -40°C	25pcs	0/1
7	High Temperature/ High Humidity	1000Hrs.	85°C/85%RH	25pcs	0/1

2) Criteria for Judging the Damage:

Item	Symbol	Test Conditions	Criteria for Judgment	
			Min	Max
Forward Voltage	VF	IF=60mA	---	F.V.*)×1.1
Reverse Current	IR	VR=5V	---	F.V.*)×2.0
Luminous Intensity	IV	IF=60mA	F.V.*)×0.7	---

*) F.V.: First Value.

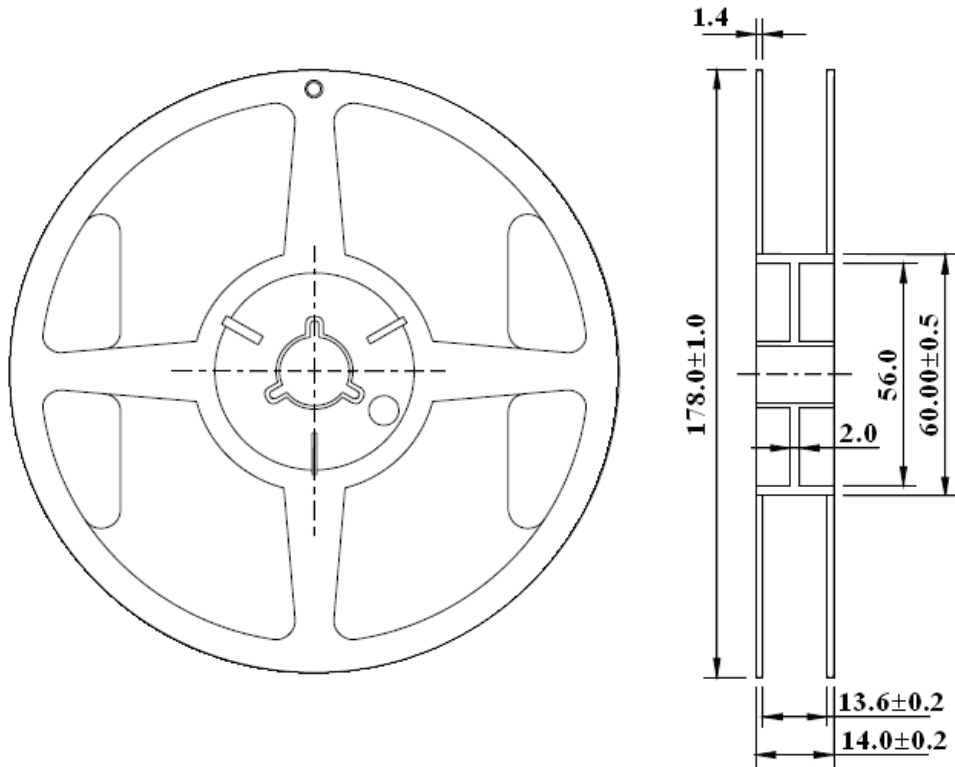
Reel Dimensions:

Unit: mm
Tolerance: ± 0.25 mm

Carrier Tape Dimensions:

Loaded quantity 1000PCS per reel.

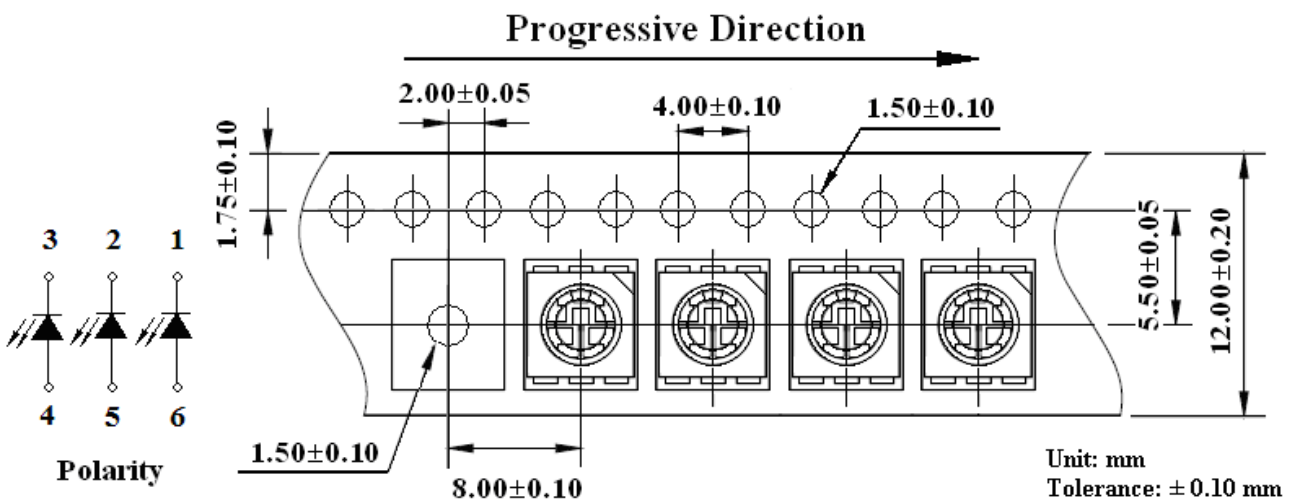

Please read the following notes before using the product:

1. Over-current-proof

Customer must apply resistors for protection, otherwise slight voltage shift will cause big current change (Burn out will happen).

2. Storage

2.1 Do not open moisture proof bag before the products are ready to use.

2.2 Before opening the package, the LEDs should be kept at 30°C or less and 80%RH or less.

2.3 The LEDs should be used within a year.

2.4 After opening the package, the LEDs should be kept at 30°C or less and 60%RH or less.

2.5 The LEDs should be used within 168 hours (7 days) after opening the package.

2.6 If the moisture adsorbent material has fabled away or the LEDs have exceeded the storage time, baking treatment should be performed using the following conditions. Baking treatment: 60±5°C for 24 hours.

3. Soldering Condition

When soldering, for Lamp without stopper type and must be leave a minimum of 3mm clearance from the base of the lens to the soldering point.

To avoided the Epoxy climb up on lead frame and was impact to non-soldering problem, dipping the lens into the solder must be avoided.

Do not apply any external stress to the lead frame during soldering while the LED is at high temperature.

Recommended soldering conditions:

Soldering Iron		Wave Soldering	
Temperature	300°C Max.	Pre-heat	100°C Max.
Soldering Time	3 sec. Max. (one time only)	Pre-heat Time	60 sec. Max.
		Solder Wave	260°C Max.
		Soldering Time	5 sec. Max.

Note: Excessive soldering temperature and / or time might result in deformation of the LED lens or catastrophic failure of the LED.

4. Soldering Iron

Each terminal is to go to the tip of soldering iron temperature less than 260°C for 5 seconds within once in less than the soldering iron capacity 25W. Leave two seconds and more intervals, and do soldering of each terminal. Be careful because the damage of the product is often started at the time of the hand solder.

5. Repairing

Repair should not be done after the LEDs have been soldered. When repairing is unavoidable, a double-head soldering iron should be used (as below figure). It should be confirmed beforehand whether the characteristics of the LEDs will or will not be damaged by repairing.



6. Caution in ESD

Static Electricity and surge damages the LED. It is recommended to use a wrist band or anti-electrostatic glove when handling the LED. All devices, equipment and machinery must be properly grounded.

X-ON Electronics

Largest Supplier of Electrical and Electronic Components

Click to view similar products for [Standard LEDs - SMD category](#):

Click to view products by [Lucky Light manufacturer](#):

Other Similar products are found below :

[LTST-C19GD2WT](#) [LTST-N683GBEW](#) [597-3006-607F](#) [597-3403-607F](#) [LTW-K140SZR40](#) [LTW-M140ZVS](#) [598-8110-100F](#) [598-8170-100F](#)
[598-8610-202F](#) [7012X7](#) [AAAF5060QBFSEEZGS](#) [12-22SURSYGC/S530-A3/E2/TR8](#) [1383SURT/S530-A3/TR1\(R\)](#) [APT1608QGW](#)
[EASV1803BA0](#) [HT-F104TW-5860](#) [SML310BATT86](#) [SML-512VWT86A](#) [SML-LX0606SISUGC/A](#) [SML-LXL1307SRC-TR](#) [SML-](#)
[LXR851SIUPGUBC](#) [LT1ED53A](#) [17-21/G6C-FM1N2B/3T](#) [FAT801-S](#) [SSL-LXA227IC-TR31A](#) [AM27ZGC03](#) [APB3025SGNC](#)
[APHK1608VGCA](#) [APT2012QGW](#) [CLMVC-FKA-CA1E1L81BB7C3C3](#) [CLYBA-FKA-CFHHL9BBB7A363](#) [CMD11504UR](#) [LTW-](#)
[020ZDCG](#) [LTW-21TS5](#) [LTW-K140SZR30](#) [HSMY-C177](#) [HT-121UYG-4739](#) [UYGT801-S](#) [KVH1C100MF6R](#) [42-21SYGC/S530-E1/TR8](#)
[YGFR411-H](#) [597-2311-402F](#) [5973212407NF](#) [597-3302-607F](#) [597-5202-407F](#) [598-8330-117F](#) [SAW8WA2A-L35M40-CA](#) [SML013WBDW1](#)
[SML522BUWT86](#) [SML-LX0402IC-TR](#)