

# *Tools and Totes*





# Tools and Totes

## Kinetic™ Super Wire Strippers



- Non-slip Santoprene™ textured grips
- Plier nose for holding and twisting wires
- Slide lock for safety and storage
- Thumb and finger valley makes stripping easier and more accurate
- “Shear-Cut™” bolt cutters

Description	Solid	Stranded	Cat. No.
Kinetic Super™ Wire Stripper	10-18	12-20	<b>45-715</b>
Kinetic Super™ Wire Stripper	14-24	16-26	<b>45-716</b>
Kinetic Super™ Wire Stripper	6-14	8-16	<b>45-718</b>

## Reflex™ Premium T®-Stripper Wire Strippers



- Ergonomic design for maximum comfort
- Curved handles reduce wrist fatigue
- Sleeves that extend to stripping head to cushion thumb and fingers
- Textured, no-slip sleeves provide a sure, easy grip

Description	Solid	Stranded	Cat. No.
Reflex™ Premium T®-Stripper Wire Stripper	10-18	12-20	<b>45-415</b>
Reflex™ Premium T®-Stripper Wire Stripper	14-24	16-26	<b>45-416</b>
Reflex™ Premium T®-Stripper Wire Stripper	22-30	24-32	<b>45-417</b>
Reflex™ Premium T®-Stripper Wire Stripper	6-14	8-16	<b>45-418</b>
Reflex™ Premium T®-Stripper – Metric	0.5mm <sup>2</sup> -4.0mm <sup>2</sup>		<b>45-425-341</b>
Reflex™ Premium T®-Cutter	Cutter		<b>45-423</b>

## Kinetic™ Reflex™ T®-Stripper Wire Strippers



- Non-slip Santoprene™ textured grips and thumb rest
- Plier nose for holding and twisting wires
- Slide lock for safety and storage
- Thumb and finger valley makes stripping easier and more accurate
- “Shear-Cut™” bolt cutters

Description	Solid	Stranded	Cat. No.
Kinetic™ Reflex™ T®-Stripper Wire Stripper	10-18	12-20	<b>45-915</b>
Kinetic™ Reflex™ T®-Stripper Wire Stripper	6-14	8-16	<b>45-918</b>

## Reflex™ Super T®-Stripper Wire Strippers



- 6/32 and 8/32 self-chasing screw-cutting holes
- Locking pawl for safe storage
- Ergonomic design for maximum comfort
- Curved handles reduce wrist fatigue
- Sleeves that extend to stripping head to cushion thumb and fingers
- Textured sleeves with extra cushioning for added comfort

Description	Solid	Stranded	Cat. No.
Reflex™ Super T®-Stripper Wire Stripper	8-16	10-18	<b>45-615</b>
Reflex™ Super T®-Stripper Wire Stripper w/static dissipative grips	14-24	16-26	<b>45-616</b>
Reflex™ Super T®-Stripper Wire Stripper	8-14	8-16	<b>45-618</b>
Reflex™ Super 12/2 & 14/2 NM Cable T®-Stripper Wire Stripper	12-2 and 14-2	—	<b>45-621</b>
Reflex™ Super 12/3 & 14/3 NM Cable T®-Stripper Wire Stripper	12-3 and 14-3	—	<b>45-622</b>

Wire Strippers



### T<sup>®</sup>-Stripper Wire Strippers

- Form-ground, knife-type blades for accurate, easy stripping without nicking insulation
- Built-in wire cutter and looping holes
- Convenient plier nose for extra gripping strength
- Laser-etched wire gauge for easy-to-read visibility
- Spring-loaded automatic opening
- Corrosion-resistant, black oxide finish
- Tough steel construction



Description	Solid	Stranded	Cat. No.
T <sup>®</sup> -5 T <sup>®</sup> -Stripper Wire Stripper	10-18	12-20	45-120
T <sup>®</sup> -6 T <sup>®</sup> -Stripper Wire Stripper	14-24	16-26	45-121
T <sup>®</sup> -7 T <sup>®</sup> -Stripper Wire Stripper	22-30	24-32	45-125
T <sup>®</sup> -8 T <sup>®</sup> -Stripper Wire Stripper	6-14	8-16	45-124
T <sup>®</sup> -Stripper Wire Stripper – Metric	0.75-6mm <sup>2</sup>		45-120-341
T <sup>®</sup> -Stripper Wire Stripper – Metric	0.5-4mm <sup>2</sup>		45-125-341

### NM Cable T<sup>®</sup>-Stripper Wire Strippers

- Easy, one-step stripping of outer jacket of NM cable – no slitting required
- Versatility to strip, cut and loop conductor wires with precision and ease
- Stripping holes for 12 or 14 AWG solid wire
- Locking pawl for safe storage



Description	Cat. No.
14/2 NM Cable T <sup>®</sup> -Stripper Wire Stripper	45-248
12/2 NM Cable T <sup>®</sup> -Stripper Wire Stripper	45-249
Reflex™ Super 12/2 & 14/2 NM Cable T <sup>®</sup> -Stripper Wire Stripper	45-621
Reflex™ Super 12/3 & 14/3 Cable T <sup>®</sup> -Stripper Wire Stripper	45-622

### NM Cable Dual-Hole T<sup>®</sup>-Stripper Wire Stripper

- Stripping holes for stripping two 12 AWG or two 14 AWG wires simultaneously
- Ability to strip both conductor wires of NM cable at one time



Description	Wire Range	Cat. No.
Premium T <sup>®</sup> -14 T <sup>®</sup> -Stripper Wire Stripper	12 or 14 AWG solid	45-247

Romex<sup>®</sup> is a registered trademark of Southwire.

### Super T<sup>®</sup>-Stripper Wire Strippers

- 6-32 and 8-32 self-chasing screw-cutting holes (not available on metric stripper)
- Curved, cushion-grip handles for ergonomic comfort
- Locking pawl to keep stripper in closed position
- Built-in wire cutter and looping holes
- Convenient plier nose for extra gripping strength
- Laser-etched wire gauge for easy-to-read visibility
- Spring-loaded automatic opening
- Tough steel construction, corrosion-resistant, black oxide finish



Description	Solid	Stranded	Cat. No.
Super T <sup>®</sup> -5 T <sup>®</sup> -Stripper Wire Stripper	8-16	10-18	45-315
Super T <sup>®</sup> -8 T <sup>®</sup> -Stripper Wire Stripper	6-14	8-16	45-318
Super T <sup>®</sup> -Stripper Wire Stripper – Metric	0.5-4mm <sup>2</sup>		45-310-341
Super T <sup>®</sup> -Stripper Wire Stripper – Metric	0.75-6mm <sup>2</sup>		45-315-341
Super T <sup>®</sup> -Stripper Wire Stripper – Metric	0.5-4mm <sup>2</sup>		45-317-341

### Lil' Ripper Stripper™

- Rips Romex<sup>®</sup> outer jacket cleanly and quickly
- Clips outer sheathing to remove excess Romex<sup>®</sup> jacket
- Strips inner conduit wires
- Looping holes loop wire for screw-on connections
- Twist-Assist™ tightens most popular sizes of winged twist-on connectors
- Injection molded elastomer grip provides a comfortable, slip resistant grip
- Strip length measuring scale allows for quick and easy measurements
- Conveniently fits in your pocket



Description	Cat. No.
Lil' Ripper Stripper™	45-025

### Reflex™ Super T<sup>®</sup>-Stripper Wire Strippers

- 6/32 and 8/32 self-chasing screw-cutting holes
- Locking pawl for safe storage
- Ergonomic design for maximum comfort
- Curved handles reduce wrist fatigue
- Sleeves that extend to stripping head to cushion thumb and fingers
- Textured sleeves with extra cushioning for added comfort



Description	Solid	Stranded	Cat. No.
Reflex™ Super 12/2 & 14/2 NM Cable T <sup>®</sup> -Stripper Wire Stripper	12-2 and 14-2	—	45-621
Reflex™ Super 12/3 & 14/3 NM Cable T <sup>®</sup> -Stripper Wire Stripper	12-3 and 14-3	—	45-622



# Tools and Totes

## Super T®-Stripper Wire Strippers—Static Dissipative

- Static dissipative grips for dispersing static charge buildup through the operator to the ground (operator must be grounded via wrist strap or other grounding device)



- Locking pawl to keep stripper in closed position

Description	Solid	Stranded	Cat. No.
Super T®-6 T®-Stripper Wire Stripper w/static dissipative grips	14-24	16-26	<b>45-316</b>
Super T®-7 T®-Stripper Wire Stripper w/static dissipative grips	22-30	24-32	<b>45-317</b>

## V-Notch Stripper

- Cuts copper or aluminum wire, solid or stranded
- Rotating cam wheel adjusts to strip 10-24 AWG wire
- Looping holes for solid wire
- Locking hasp



Description	Cat. No.
V-Notch Stripper	<b>45-101</b>

## 7-in-1 Stripper



- Versatile, seven-function tool features precision-ground stripping blades, cushioned grips and plier nose
- Strips 8 – 16 AWG solid and 10 – 18 AWG stranded wire
- Crimps bare and insulated terminals for 10 – 22 AWG wire, RG-59 coax connectors and 7 to 8mm auto ignition connectors
- Cuts unhardened wire, bolts and screws (4-40, 6-32, 8-32, 10-24 and 10-32) and reforms threads
- Cuts stranded, solid, Romex® and U.F. wire to 8 AWG
- Reams and de-burrs conduit
- Gauges and loops wire

Description	Cat. No.
7-in-1 Stripper	<b>45-777</b>

Romex® is a registered trademark of Southwire.

## Ringer™ Shielded Cable Stripper

- Precision stripping for most non-round cable, including extruded Teflon®, Kapton®, Tefzel®, Kynar® and high-temperature insulations
- Spring-loaded head provides even tension
- Heat-treated, stainless-steel blades resist wear
- Fixed blades are sized to insulation thickness, for accurate stripping
- V-notch jaw automatically positions and holds cable
- Wire guide roller maintains stripping head alignment, for square, clean cuts



Description	Blade	Color	Cat. No.
Cable Stripper, 5 Mil insulation, includes blade	K-6492	(Orange)	<b>45-401</b>
Cable Stripper, 8-10 Mil insulation, includes blade	K-6493	(Yellow)	<b>45-402</b>
Cable Stripper, Cable diameters up to 0.12 in.	sold separately	(Blue)	<b>45-400</b>
Cable Stripper, Cable diameters from 0.12 in. to 0.22 in.	sold separately	(Red)	<b>45-403</b>
Cable Stripper, w/"deep V" forcable diameters up to 0.30 in.	sold separately	(Green)	<b>45-404</b>

## Replacement Blades

Cutting Depth	Cat. No.	Cutting Depth	Cat. No.	Cutting Depth	Cat. No.
.0030 in.	<b>K-6491</b>	.0100 in.	<b>K-6497</b>	.0180 in.	<b>K-6503</b>
.0044 in.	<b>K-6492</b>	.0110 in.	<b>K-6498</b>	.0200 in.	<b>K-6504</b>
.0060 in.	<b>K-6493</b>	.0120 in.	<b>K-6499</b>	.0220 in.	<b>K-6505</b>
.0070 in.	<b>K-6494</b>	.0130 in.	<b>K-6500</b>	.0250 in.	<b>45-2108-1</b>
.0080 in.	<b>K-6495</b>	.0140 in.	<b>K-6501</b>		
.0090 in.	<b>K-6496</b>	.0160 in.	<b>K-6502</b>		

Select blade with cutting depth less than insulation thickness.

## Wire Stops



Description	Cat. No.
Up to 2-1/2 in.	<b>LB-825</b>
2-1/2 in. to 5 in.	<b>LB-840</b>

## IDEAL Gripper™

Description	Cat. No.
Slug Remover	<b>45-333</b>

Teflon® and Kapton® are registered trademarks of E.I. duPont de Nemours and Company. Kynar® is a registered trademark of Pennwall.



Wire Strippers



Wire Strippers

### Data T<sup>®</sup>-Cutter Wire Cutters



- Cuts round communication cable and maintains cable geometry for better cable performance
- Cuts multi-pair cable up to .500 in. (12.7mm) and coaxial cable up to RG-9/U
- Suitable for soft cables (not ACSR)
- Steel reinforced center conductors can be trimmed with bolt cutting holes
- Cushioned comfort grip handles
- Locking latch keeps tool closed in pouch
- Data T<sup>®</sup>-Cutter II designed for RG-58 and RG-6 coaxial cable

Description	Cat. No.
Data T <sup>®</sup> -Cutter	45-074
Data T <sup>®</sup> -Cutter II	45-075

### Combo Tool

- Convenient, four-function tool features precision-ground stripping holes and knife-to-anvil cutting blades
- Crimps bare and insulated terminals
- Strips 8 – 20 AWG solid and 10 – 22 AWG stranded wire
- Cuts unhardened bolts (4-40, 6-32, 8-32, 10-24 and 10-32) and reforms threads



Description	Cat. No.
Combo Tool	30-428

### Multi-Crimp Strip Tool

- Cuts wire
- Crimps insulated and non-insulated wires
- Cuts bolts
- Strips 10-22 AWG wire



Description	Cat. No.
Multi-Crimp Strip Tool	45-778

### T<sup>®</sup>-Cutter Wire Cutters

- Hardened steel, sheer-type blades
- Spring-loaded automatic opening
- Convenient plier nose for extra gripping strength
- Corrosion-resistant, black oxide finish
- Tough steel construction
- Locking tab keeps spring in place

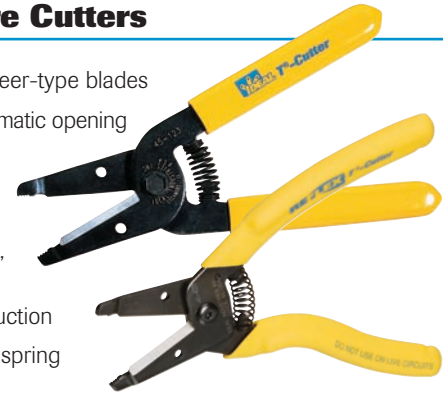

Description	Wire Range	Cat. No.
T <sup>®</sup> -Cutter Wire Cutter	Up to 1/2 in. O.D. fine-stranded wire and 10 AWG solid wire	45-123
Reflex™ Premium T <sup>®</sup> -Cutter Wire Cutter	Up to 1/2 in. O.D. fine-stranded wire and 10 AWG solid wire	45-423

### T<sup>®</sup>-Cutter Lite Wire Cutter

In today's cutting-edge electronic production and assembly operations, the T<sup>®</sup>-Cutter Lite is a "must-have." Stranded or solid, copper or aluminum, this wire cutter cuts cleanly and accurately. Compact and lightweight with a cushioned ESD grip prove comfort and precision go hand-in-hand.

- Knife-type blade provides a shear-type cut
- Lightweight, compact design
- Perfect for copper and aluminum wire
- Cushioned ESD grip



Description	Cat. No.
T <sup>®</sup> -Cutter Lite Wire Cutter	45-260

### Coax Strip and Crimp Tool

- Precision, form-ground stripping holes remove outer jacket and insulation from RG-59 and RG-6 coaxial cable
- Durable blades cut copper-coated steel conductors
- Three crimping nests for crimping F-connectors and ring terminals



Description	Cat. No.
Coax Strip & Crimp Tool	30-433
Coax Strip & Crimp Tool w/F-Connectors	30-433F

# Tools and Totes

## Cable Ripper

- Slits cable sheathing before stripping wires
- Quick, clean and easy end or mid-run removal of jacket
- Convenient built-in wire gauge



Description	Cat. No.
Side Entry Cable Ripper	45-118

## Underground Feeder (UF) Cable Stripper

- Self-adjusting stripping blades automatically select proper position
- Strips 12 AWG solid to 14 AWG Underground Feeder (UF) Cable
- Strips Twin and Earth cable
- Open-throat construction allows unlimited strip length
- Neatly removes outer cable sheath and then inner wire sheathing to desired lengths
- Lightweight, ergonomic design reduces user fatigue



Description	Cat. No.
Underground Feeder Cable Stripper	45-235

## Grip-N-Strip™ End Stripper

- Self-adjusting stripping blades automatically select proper position
- Strips 12 AWG solid to 20 AWG stranded PVC insulated wire
- Dual strip-length gauge marks at 3/16 in. and 5/16 in.
- Cuts up to 12 AWG solid wire
- Lightweight, ergonomic design reduces user fatigue
- Reinforced fiberglass construction
- Hardened steel blades for extra strength and longer life



Description	Cat. No.
Grip-N-Strip™ End Stripper	45-227



## Sir Nickless Cutter

TO SEVER AND PROTECT ARMORED CABLE

- Handles all common BX, MCAP, MC and Flex cables
- Blade cuts armor without damage to internal conductors
- Splices cleanly through casings with only a few turns
- Handle knob stores up to six replacement blades



Description	Cat. No.
Replacement blades (5/pack)	35-781
Rotary Armored Cable Cutter	35-782

## Round Cable Slitting and Ringing Tool

- Cuts around cable jacket as well as slits the length of jacket for easy removal
- Use with single or multiple conductor cable up to 1.75 in. O.D.
- Blade adjusts for jacket thicknesses up to .125 in.
- Spare blade in handle base



Description	Cat. No.
Cable Stripper for 1/4 in. to 3/4 in. O.D.	45-128
Cable Stripper for 3/4 in. to 1 1/2 in. O.D.	45-129
Replacement Blades for 45-128 and 45-129 (2/pkg.)	L-7486

## Stripmaster® Wire Strippers

- One-step stripping enhances productivity
- Spring-action motion increases leverage and reduces operator fatigue
- Precision-ground, knife-type blades provide clean, accurate stripping



Description	Cat. No.
Stripmaster® Wire Stripper, 10-22 AWG	45-092
Stripmaster® Wire Stripper, Coax RG-6	45-262
Stripmaster® Wire Stripper, 10-22 AWG	45-292

See Section D for complete Stripmaster® Wire Stripper line.

Wire Strippers





# LASERedge™

LASERedge™ pliers use high carbon, 1080 steel, which provides extra strength and hardness without sacrificing flexibility. It is one of the reasons our tools outperform the competition in performance

and durability. All of our LASERedge tools have laser-hardened blades and teeth, which are more precise and provide better durability for strenuous applications like cutting steel or ACSR.

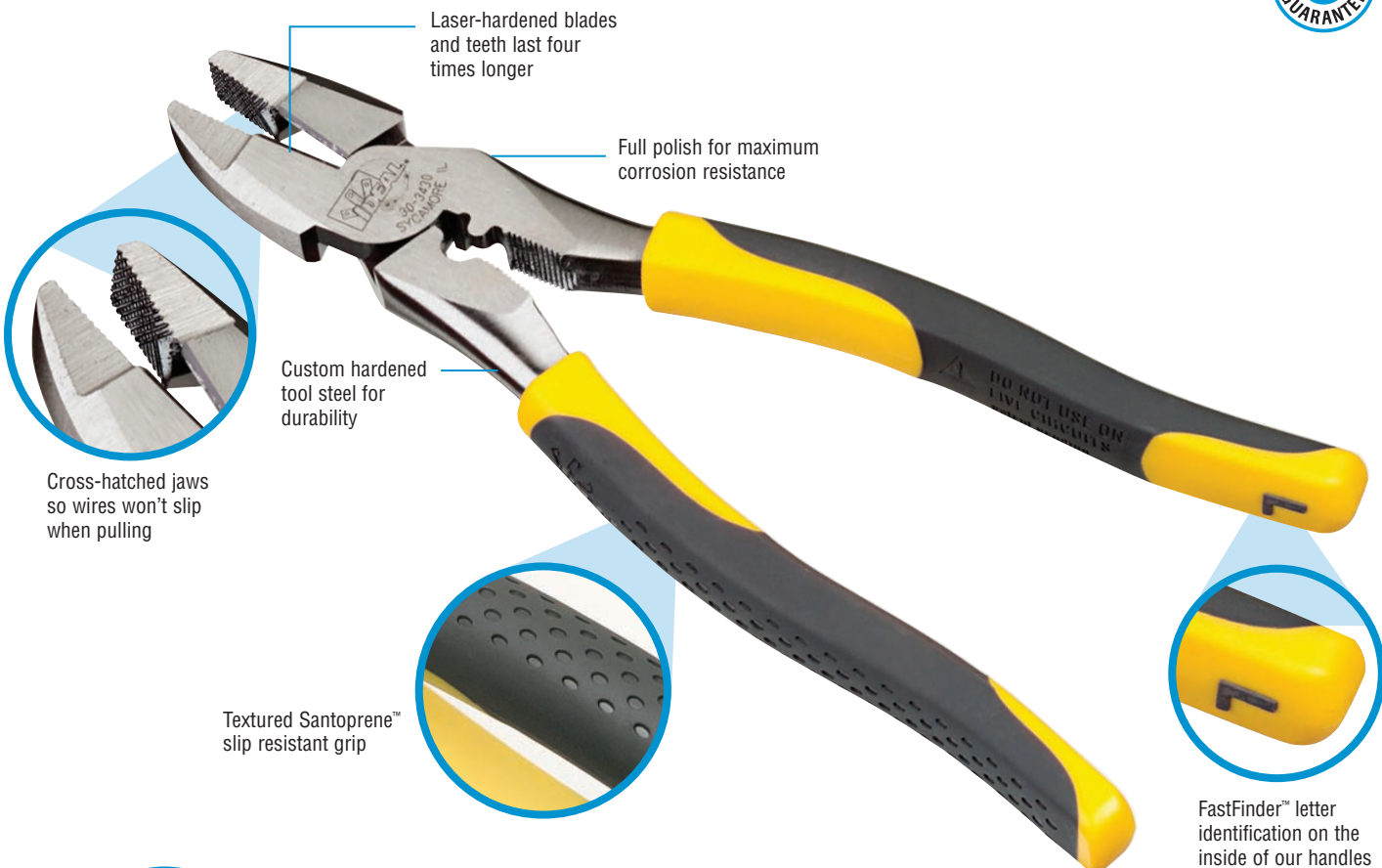

Hand Tools

**Blade Design**  
 LASERedge pliers feature “knife-to-anvil” cutting blades for long life.  
 (Ideal for cutting screws, nails, hardened wire and ACSR)





# Tools and Totes



## Side-Cutting Pliers

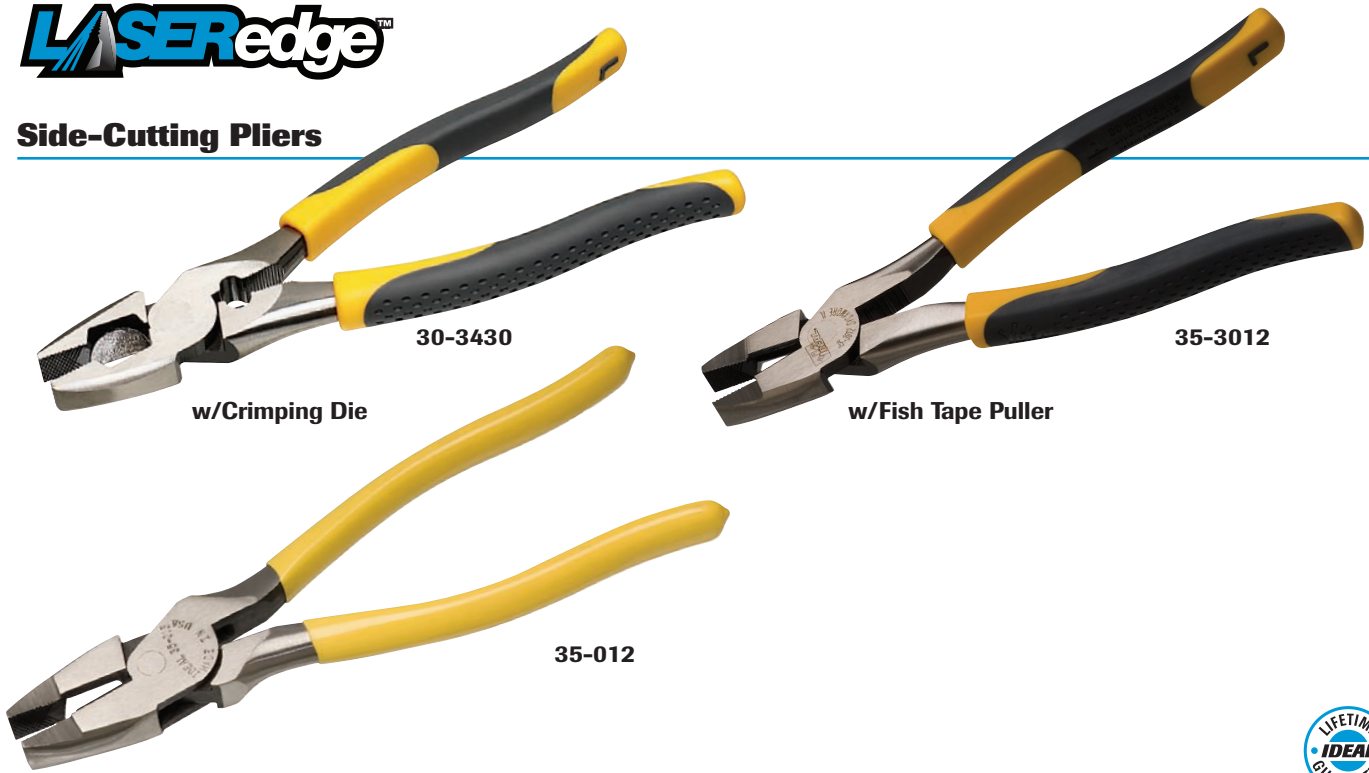

- Drop-forged, high-carbon steel construction withstands toughest applications
- Knife-to-anvil blades never need resharpener
- Cuts hardened wire, bolts and ACSR
- Laser-hardened blades and serrated jaws for long-term durability
- High-leverage design provides 40% more cutting power
- Unique reverse rivet protects smooth action of plier movement
- Vinyl-coated, comfort-grip handles for a secure grip

Description (Smart-Grip™ Handles)	Cat. No.
9-1/4 in. New England nose high-leverage w/fish tape puller	<b>35-3012</b>
9-1/4 in. New England nose high-leverage w/crimping die	<b>30-3430</b>
Description (Dipped Handles)	Cat. No.
9-1/4 in. New England nose high-leverage w/fish tape puller	<b>35-012</b>
9-1/4 in. New England nose high-leverage w/crimping die	<b>30-430</b>



Hand Tools

## Premium Electrician's Side-Cutting Pliers

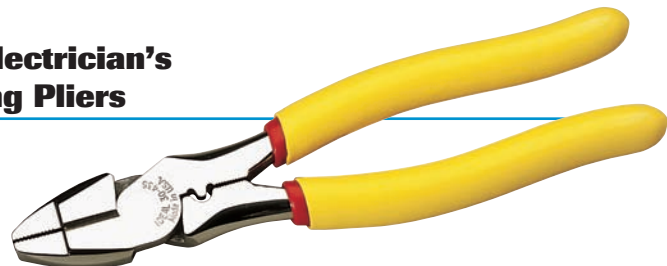

All of the features of the Side-Cutting Pliers plus:

- Mirror-polished finish to maintain premium appearance
- Double-dipped grips for extra cushioning comfort

Description (Dipped Handles)	Cat. No.
9-1/4 in. New England high-leverage w/fish tape puller and crimping die	<b>30-435</b>



### Diagonal-Cutting Pliers



8 in. Diagonal

35-3028

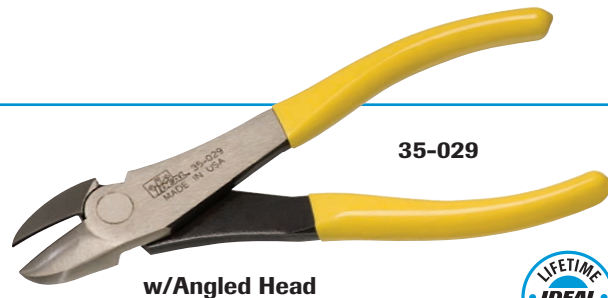

w/Angled Head

35-029



- Drop-forged, high-carbon steel construction withstands toughest applications
- Knife-to-anvil blades never need resharpening
- Laser-hardened blades cut hardened wire, bolts and ASCR
- Vinyl-coated, comfort-grip handles for a secure grip
- High-leverage design provides 40% more cutting power
- Models 35-029 and 35-3029 feature a convenient angled head for hard-to-reach areas and rocking out nails

Description (Smart-Grip™ Handles)	Cat. No.
8 in. High-leverage Diagonal	35-3028
8 in. High-leverage Diagonal w/angled head	35-3029
Description (Dipped Handles)	Cat. No.
8 in. High-leverage Diagonal	35-028
8 in. High-leverage Diagonal w/angled head	35-029

Hand Tools

### Long-Nose Pliers

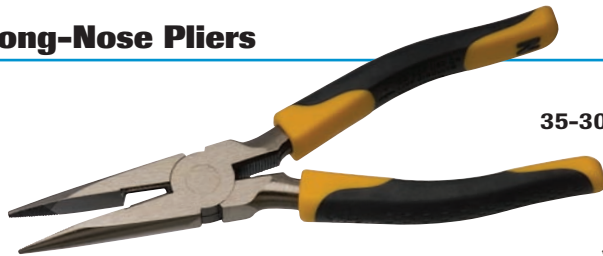

35-3038

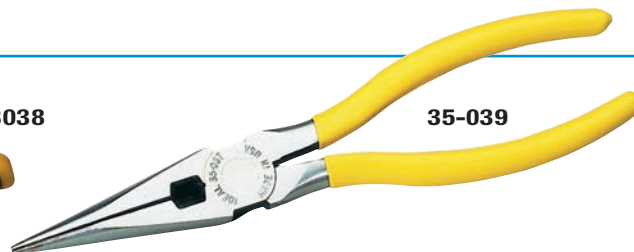

35-039



- Narrow profile head designed for working in tight areas
- Serrated jaws provide secure gripping surface
- Drop-forged, high-carbon steel construction
- Knife-to-anvil blades never need resharpening
- Laser-hardened blades cut hardened wire, bolts and ASCR
- Vinyl-coated, comfort-grip handles for a secure grip

Description (Smart-Grip™ Handles)	Cat. No.
8-1/2 in. Long Nose w/Cutter	35-3038
Description (Dipped Handles)	Cat. No.
6 in. Long Nose w/Cutter	35-036
7-3/4 in. Long Nose w/Cutter	35-037
8-1/2 in. Long Nose w/Cutter	35-038
8-1/2 in. w/Cutter & stripping holes for 12 & 14 AWG wire	35-039

### Tongue and Groove Pliers



35-3430



35-460



- Patented undercut tongue and groove design ensures solid grip
- Patented reinforced flange protects against breakage
- Laser-hardened teeth remain sharp longer
- Drop-forged, high-carbon steel construction
- Vinyl-coated, comfort-grip handles for a secure grip

Description (Smart-Grip™ Handles)	Jaw Opening (Inches)	Cat. No.
10 in. Tongue & Groove Pliers	2	35-3430
Description (Dipped Handles)	Jaw Opening (Inches)	Cat. No.
6-1/2 in. Tongue & Groove Pliers	7/8	35-426
9-1/2 in. Tongue & Groove Pliers	1-1/2	35-420
10 in. Tongue & Groove Pliers	2	35-430
12 in. Tongue & Groove Pliers	2-1/4	35-440
16 in. Tongue & Groove Pliers	4-1/4	35-460

# Tools and Totes



## Cable Cutters

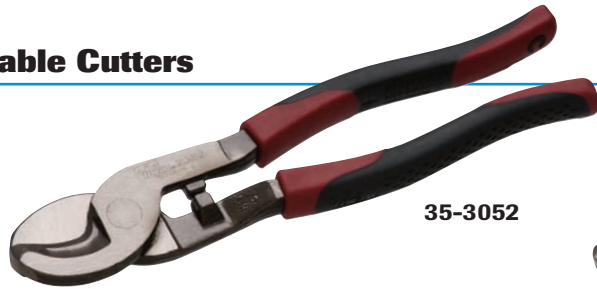

35-3052

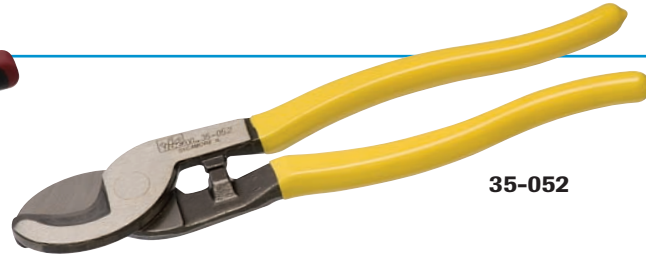

35-052



- Drop-forged, high-carbon steel construction
- Precision-ground, hardened cutting edges provide accurate cuts without cable distortion
- Designed for maximum leverage with minimum effort
- Cuts 2/0 copper and 4/0 aluminum (not for use on ACSR)
- Vinyl-coated, comfort-grip handles

Description (Smart-Grip™ Handles)	Cat. No.
9-1/2 in. Cable Cutter	35-3052
Description (Dipped Handles)	Cat. No.
9-1/2 in. Cable Cutter	35-052

## Multi-Crimp Tools



30-3429

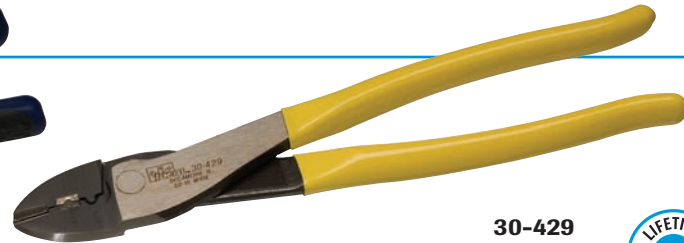

30-429



- Crimps bare or insulated terminals and splices on 10 – 22 AWG wire
- Knife-to-anvil blades never need sharpening
- Excellent leverage for easy crimping and cutting
- Drop-forged, high-carbon steel construction
- Vinyl-coated handles provide a solid, comfortable grip

Description (Smart-Grip™ Handles)	Cat. No.
9-3/4 in. Multi-Crimp Tool	30-3429
Description (Dipped Handles)	Cat. No.
9-3/4 in. Multi-Crimp Tool	30-429

## Crimp Tool

- Crimps all IDEAL crimp sleeves
- Excellent leverage for right-angle, double-indent crimps
- Cuts and twists wire
- Vinyl-coated handles provide a solid, comfortable grip

Description	Cat. No.
Crimp Tool - 10-1/4 in.	30-425



Hand Tools



*WireMan™ pliers provide professional results for everyday use. These tools are the workhorse of electrical pliers; they are rugged yet precise, providing exceptional durability, easy cutting and a lifetime of quality use.*



Hand Tools



**Blade Design**

WireMan pliers feature “knife-to-knife” cutting blades for easy cuts.



**Diagonal**



**Long Nose**



**Tongue & Groove**



**Cable Cutter**



**Crimper**



# Tools and Totes



## Side-Cutting Pliers



- Custom chrome vanadium steel for durability
- High leverage pivot requires less cutting force
- Sharp, knife-to-knife blades for easy cutting
- Induction hardened teeth for long life
- Cross-hatched jaws so wires won't slip when pulling
- Ergonomic handles for comfortable, all-day use

Description (Smart-Grip™ Handles)	Cat. No.
7 in. Cutting Pliers	30-4419
8 in. Side-Cutting Pliers	30-4420
9-1/4 in. Side-Cutting Pliers	35-4012
9-1/4 in. Side-Cutting Pliers w/crimp and fish tape puller	30-4430
Description (Dipped Handles)	Cat. No.
7 in. Cutting Pliers	30-5419
8 in. Side-Cutting Pliers	30-5420
9-1/4 in. Side-Cutting Pliers	35-5012
9-1/4 in. Side-Cutting Pliers w/crimp and fish tape puller	30-5430

Hand Tools

## Diagonal-Cutting Pliers



- Custom chrome vanadium steel for durability
- High leverage pivot requires less cutting force
- Sharp, knife-to-knife blades for easy cutting
- Induction hardened teeth for long life
- Ergonomic handles for comfortable, all-day use

Description (Smart-Grip™ Handles)	Cat. No.
6 in. Diagonal-Cutting Pliers	35-4026
8 in. Diagonal-Cutting Pliers	35-4028
8 in. Diagonal-Cutting Pliers w/angled head	35-4029
Description (Dipped Handles)	Cat. No.
6 in. Diagonal-Cutting Pliers	35-5026
8 in. Diagonal-Cutting Pliers	35-5028
8 in. Diagonal-Cutting Pliers w/angled head	35-5029



### Long-Nose Pliers

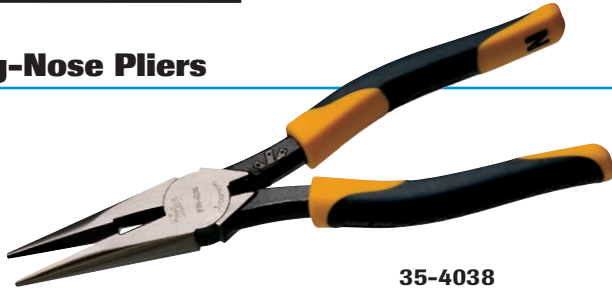

35-4038



35-5035



Hand Tools

- Custom chrome vanadium steel for durability
- High leverage pivot requires less cutting force
- Sharp, knife-to-knife blades for easy cutting
- Induction hardened teeth for long life
- Cross-hatched jaws so wires won't slip when pulling
- Ergonomic handles for comfortable, all-day use

Description (Smart-Grip™ Handles)	Cat. No.
6 in. Long-Nose Pliers w/Strip & Crimp	35-4035
6 in. Long-Nose Pliers	35-4036
8 in. Long-Nose Pliers	35-4038
Description (Dipped Handles)	Cat. No.
6 in. Long-Nose Pliers w/Strip & Crimp	35-5035
6 in. Long-Nose Pliers	35-5036
8 in. Long-Nose Pliers	35-5038

### Tongue and Groove Pliers



35-4430



35-5430



- Custom chrome vanadium steel for durability
- Ergonomic handles for comfortable, all-day use

Description (Smart-Grip™ Handles)	Cat. No.
10 in. Tongue & Groove Pliers	35-4430
Description (Dipped Handles)	Cat. No.
10 in. Tongue & Groove Pliers	35-5430

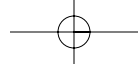

# Tools and Totes



## Multi-Crimp Tools

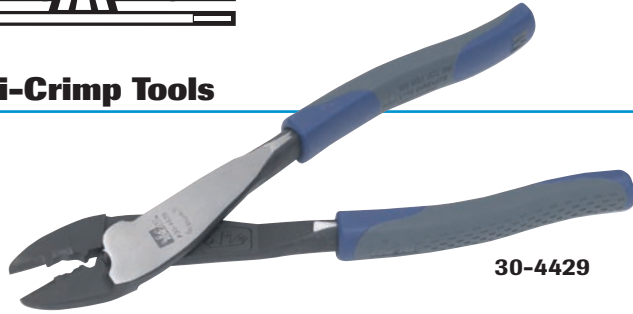

30-4429

- Custom chrome vanadium steel for durability
- High-leverage pivot requires less force
- Ergonomic handles for comfortable, all-day use
- Cuts, crimps and splices 10 – 22 AWG wire for insulated and non-insulated crimp connectors

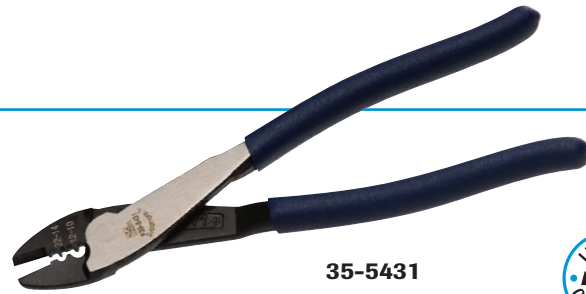

35-5431



Description (Smart-Grip™ Handles)	Cat. No.
9-1/4 in. Multi-Crimp Tool	30-4429
9-1/4 in. Multi-Crimp Tool - Bare Terminals	35-4431
Description (Dipped Handles)	Cat. No.
9-1/4 in. Multi-Crimp Tool	30-5429
9-1/4 in. Multi-Crimp Tool - Bare Terminals	35-5431

## Cable Cutters



35-4052

- Custom chrome vanadium steel for durability
- High-leverage pivot requires less force
- Sharp, knife-to-knife blades for easy cutting
- Induction hardened teeth for long life
- Ergonomic handles for comfortable, all-day use



35-5052



Description (Smart-Grip™ Handles)	Cat. No.
9 in. 2/0 Cable Cutter	35-4052
Description (Dipped Handles)	Cat. No.
9 in. 2/0 Cable Cutter	35-5052

## Tenite Grips

- Fits LASERedge™ and WireMan™ Pliers
- Not insulated from electrical shock
- Boil in water to soften for easy installation onto handles



Description	Cat. No.
Replacement grips for 6 in. pliers (one pair)	35-006
Replacement grips for 7 in. pliers (one pair)	35-007
Replacement grips for 8 in. or 9 in. pliers (one pair)	35-008

Hand Tools

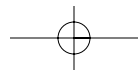



## Twist-a-Nut™ Screwdriver/Nutdriver

Textured Santoprene™ grip provides excellent torque and resists perspiration, water, oil and chemicals

Six torsion bars provide exceptional grip

Accu-Loop™ Wire Looping Hole

(Image actual size.)

Patented Wire-Nut® Wire Connector Wrench accepts a wide variety of connectors.

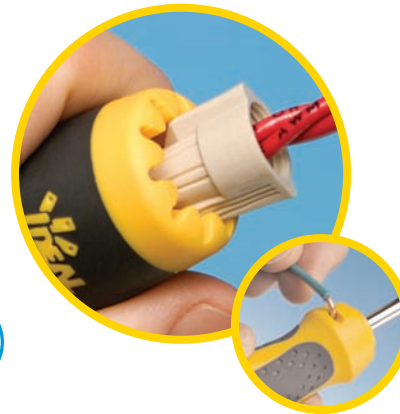

Accu-Loop™ Wire looping holes



Patented Wire-Nut® Wrench accepts a wide variety of IDEAL wire connectors (and others) including:



Wing-Nut®



Wire-Nut®



Twister®



B-Cap®



WingTwist™ / WireTwist™

## 9-in-1 Ratch-a-Nut™ Screwdriver



- Ratcheting wire connector wrench prevents finger fatigue and gets in tight spots
- Premium screwdriver ratchet mechanism can handle high torque without failure
- Ergonomic, slip-free comfort grip
- Accepts Twist-a-Nut™ replacement bits
- Includes: 1/4 in. and 3/16 in. slotted, #1 & #2 Phillips, 1/4 in., 5/16 in., 7/16 in. nutdrivers, ratcheting screwdriver end, ratcheting wire connector wrench and wire-looping hole in handle

Description	Cat. No.
9-in-1 Ratch-a-Nut™ Screwdriver	35-988

### Replacement Bits (for both Ratch-a-Nut™ and Twist-a-Nut™)

Description	Cat. No.
1/4 in. slotted – #2 Phillips	35-911
3/16 in. slotted – #1 Phillips	35-912
1/4 in. slotted – #2 Square Recess	35-913
3/16 in. slotted – #1 Square Recess	35-914
#15 & #10 Torx®	35-915

Torx® is a trademark of Camcar division of Textron, Inc.

## 7-in-1 Twist-a-Nut™ Screwdriver/Nutdrivers



- Includes universal Wire-Nut® Wire Connector Wrench in handle to help install twist-on wire connectors
- Includes wire-looping hole in handle
- Includes #1 & #2 Phillips, 1/4 in. & 3/16 in. slotted, 1/4 in. & 5/16 in. Nutdriver
- #35-909 includes #1 & #2 Square Recess in place of #1 & #2 Phillips
- Twist-a-Nut™ handle is interchangeable with new conduit deburrer head (#35-096) and 6-in-1 Tap Tool (#35-922)

Description	Cat. No.
7-in-1 Twist-a-Nut™ Screwdriver/Nutdriver	35-908
7-in-1 Twist-a-Nut™ Screwdriver/Nutdriver with square tip	35-909

### Replacement Bits (for both Ratch-a-Nut™ and Twist-a-Nut™)

Description	Cat. No.
1/4 in. slotted – #2 Phillips	35-911
3/16 in. slotted – #1 Phillips	35-912
1/4 in. slotted – #2 Square Recess	35-913
3/16 in. slotted – #1 Square Recess	35-914
#15 & #10 Torx®	35-915

Torx® is a trademark of Camcar division of Textron, Inc.

Hand Tools







# Tools and Totes

## Twist-a-Nut™ Pro Electrician's Screwdrivers



- Convenient Wire-Nut® Wire Connector Wrench in end of handle
- Wire-looping hole in handle
- Vapor-blasted tip prevents plate chipping
- Tough, chrome vanadium steel shank
- Precision ground tip provides secure fit in screw slot



Description		Cat. No.
#2 x 6 in. Robertson		30-330
1/4 in. x 4 in. Slotted		30-331
#2 x 4 in. Phillips		30-332
1/4 in. x 6 in. Slotted Cabinet Tip		30-333

## 6-in-1 Twist-a-Nut™ Tapping Tool



- Forms new threads, re-forms burred threads and cleans out obstructions
- Reversible, high-carbon tap with three clearly marked thread sizes on each end
- Handle is interchangeable with 7-in-1 Screwdriver (#35-908) and Conduit Deburrer (#35-083)

Description	Cat. No.
Twist-a-Nut™ Tapping Tool includes: 6-32, 8-32 & 10-32 on one tapping side, 10-24, 12-24 & 1/4-20 on the other	35-922
Twist-a-Nut™ Shaft assembly includes: Collar, 35-422 & 35-423	35-923

## Twist-a-Nut™ Conduit Deburring Tools



- Deburrs inside and outside edges of 1/2 in., 3/4 in. and 1 in. thin wall conduit
- Hooded tip tightens EMT fitting set screws without slipping
- Square tip "seats" much more quickly on fitting screws than slotted version
- Head removes and is interchangeable with IDEAL 7-in-1 Twist-a-Nut™ Screwdriver shaft (#35-908)
- Head can be used in drill or cordless screwdriver
- Universal Wire-Nut® Wire Connector Wrench in handle end eases installation of twist-on connectors
- Lifetime guarantee (excludes blades)

Accu-Loop™ wire looping holes



Description	Cat. No.
Conduit Deburring Tool, slotted tip	35-083
Conduit Deburring Tool - head only, slotted tip	35-096
Conduit Deburring Tool - #2 square tip	35-075
Conduit Deburring Tool - head only, #2 square tip	35-098
Replacement Blades (2/pack)	35-097

## Twist-a-Nut™ Conduit Wiring Kit

- Includes Twist-a-Nut™ Screwdriver (35-908), Twist-a-Nut™ Deburring Head - Square Tip (35-098), Twist-a-Nut™ Tap Tool Shaft (35-923), Three Spare Bits (1/4 in. slotted & #2 square, 3/16 in. slotted & #1 square, #10 & #15 Torx®), 8-Pocket Carrying Pouch (35-927)



- Nylon carrying pouch holds all three Twist-a-Nut™ tools plus room for four replacement bits or taps
- Strong easy-slide metal belt clip

Description	Cat. No.
Twist-a-Nut™ Combo Pack	35-926
Twist-a-Nut™ Carrying Pouch only	35-927

Hand Tools



## Cushioned-Grip Screwdrivers

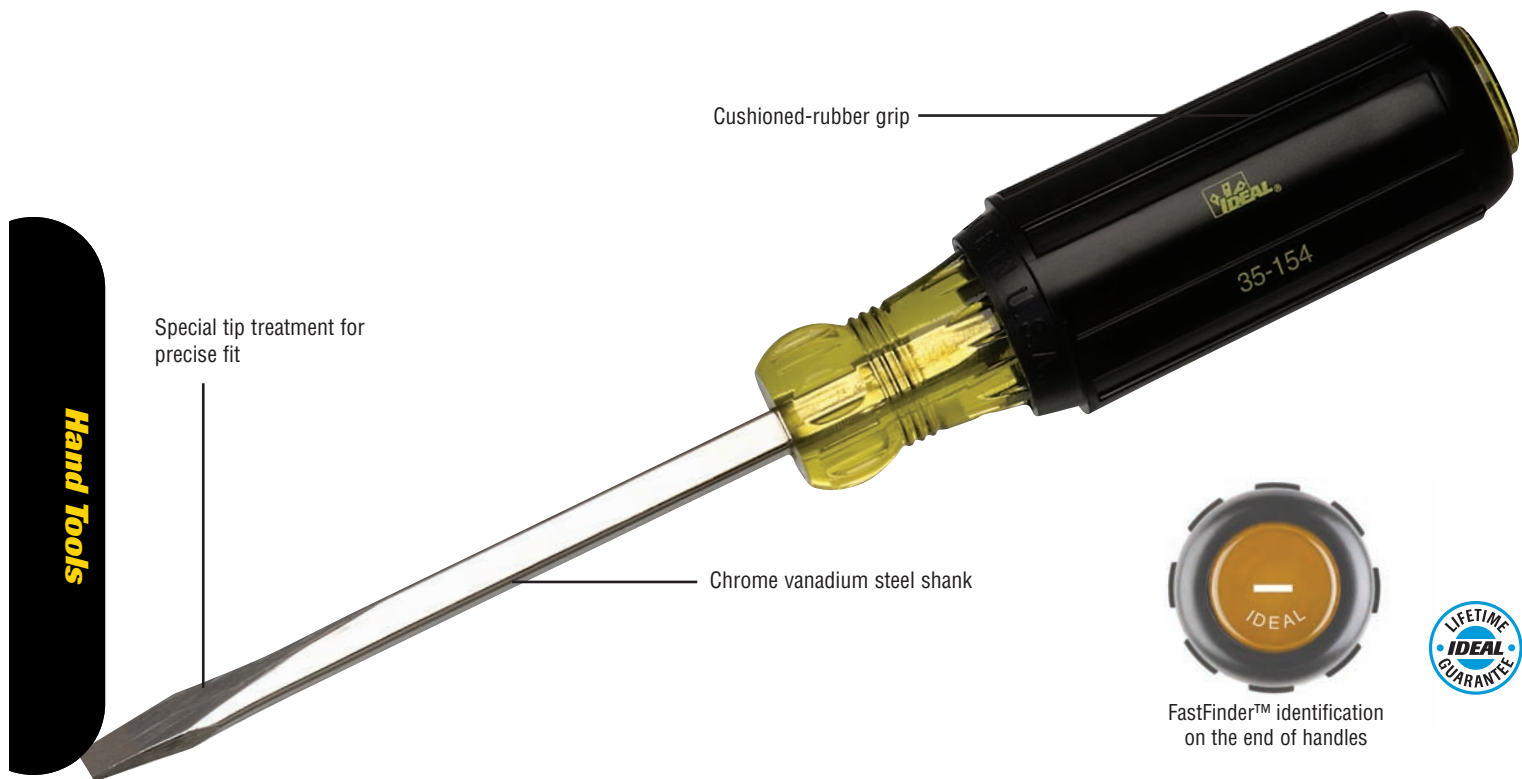

Hand Tools

### 8-Piece Screwdriver Set



**Includes:**

- 1/4 in. x 6 in. HD Cabinet
- 1/4 in. x 4 in. Square Shank HD Keystone
- 1/4 in. x 4 in. HD Keystone
- 5/16 in. x 6 in. Keystone
- 3/16 in. x 3 in. Cabinet
- 3/16 in. x 6 in. Cabinet
- Phillips #1 x 3 in.

■ Phillips #2 x 4 in.



Description	Cat. No.
8-Piece Screwdriver Set	35-298

### 5-Piece Screwdriver Set



**Includes:**

- 1/4 in. x 6 in. HD Cabinet
- 1/4 in. x 4 in. Square Shank HD Keystone
- 5/16 in. x 6 in. Keystone
- 3/16 in. x 6 in. Cabinet
- Phillips #2 x 4 in.



Description	Cat. No.
5-Piece Screwdriver Set	35-297

# Tools and Totes

## Slotted Heavy-Duty w/Keystone Tip



- Larger shank for heavy-duty applications
- Identification mark on ends
- Vapor-blasted tip prevents plate chipping
- Precision ground tip provides secure fit in screw slot
- Square-shank models offer wrench-assisted turning
- Tough, chrome vanadium steel shank
- Cushioned rubber grips

Square Shank	Blade Length	Total Length	Cat. No.
1/4 in. Shank and tip	4 in.	8-3/8 in.	<b>35-154</b>
5/16 in. Shank and tip	6 in.	11 in.	<b>35-156</b>
5/16 in. Shank and tip	8 in.	13 in.	<b>35-158</b>

Round Shank	Blade Length	Total Length	Cat. No.
1/4 in. Shank and tip	1 in.	3-3/8 in.	<b>35-161</b>
1/4 in. Shank and tip	4 in.	8-3/8 in.	<b>35-164</b>
5/16 in. Shank and tip	6 in.	11 in.	<b>35-166</b>
5/16 in. Shank and tip	8 in.	13 in.	<b>35-168</b>

## Slotted Heavy-Duty w/Cabinet Tip



- Large diameter shank for tough applications
- Identification marks on ends
- Vapor-blasted tip prevents plate chipping
- Precision ground tip provides secure fit in screw slot
- Nickel-chrome plating for corrosion resistance
- Tough, chrome vanadium steel shanks
- Cushioned rubber grip

Description	Blade Length	Total Length	Cat. No.
1/4 in. Shank and tip	4 in.	8-3/8 in.	<b>35-150</b>
1/4 in. Shank and tip	6 in.	10-3/8 in.	<b>35-151</b>
1/4 in. Shank and tip	8 in.	12-3/8 in.	<b>35-152</b>
1/4 in. Shank and tip	10 in.	14-3/8 in.	<b>35-153</b>

## Slotted Cabinet Tip



- Vapor-blasted tip prevents plate chipping
- Identification mark on ends
- Precision ground tip provides secure fit in screw slot
- Nickel-chrome plating for corrosion resistance
- Tough, chrome vanadium steel shank
- Cushioned rubber grip

Description	Blade Length	Total Length	Cat. No.
3/16 in. Shank and tip	3 in.	6-3/4 in.	<b>35-183</b>
3/16 in. Shank and tip	4 in.	7-3/4 in.	<b>35-184</b>
3/16 in. Shank and tip	6 in.	9-3/4 in.	<b>35-186</b>
3/16 in. Shank and tip	8 in.	11-3/4 in.	<b>35-188</b>
3/16 in. Shank and tip	10 in.	13-3/4 in.	<b>35-190</b>

## Phillips

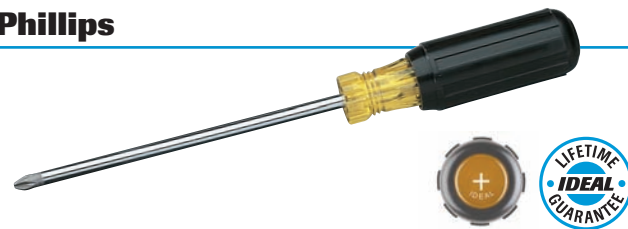

- Vapor-blasted tip prevents plate chipping
- Identification mark on ends
- Nickel-chrome plating for corrosion resistance
- Tough, chrome vanadium steel shank
- Cushioned rubber grip

Description	Blade Length	Total Length	Cat. No.
#1 Phillips	3 in.	6-3/4 in.	<b>35-193</b>
#2 Phillips	1 in.	3-3/8 in.	<b>35-191</b>
#2 Phillips	4 in.	8-3/8 in.	<b>35-194</b>
#2 Phillips	6 in.	10-3/8 in.	<b>35-195</b>
#3 Phillips	6 in.	11 in.	<b>35-196</b>

Hand Tools



Hand Tools

### Quick-Rotating

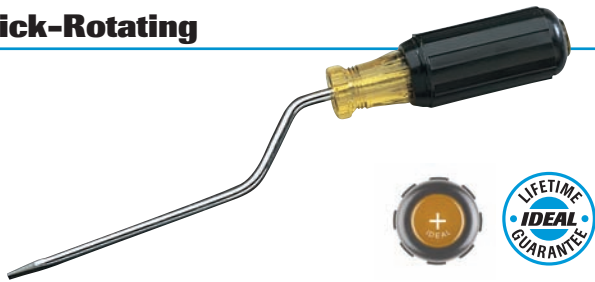

- Ideal for threading screws in switches, fixtures and anchors
- Identification mark on ends
- One-handed crank action for quick and easy use
- Vapor-blasted tip prevents plate chipping
- Precision-ground tip provides secure fit in screw slot
- Nickel-chrome plating for corrosion resistance
- Tough, chrome vanadium steel shank
- Cushioned rubber grip

Description	Total Length	Cat. No.
3/16 in. Shank and Tip	8-3/4 in.	<b>35-200</b>
#2 Phillips Tip and 1/4 in. Shank	9-3/4 in.	<b>35-203</b>

### Square Head

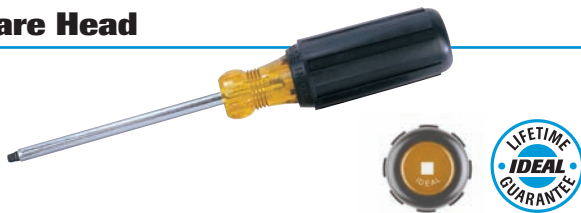

- Precise tip for square-recess screws
- Color-coded handle for easy identification
- Nickel-chrome plating for corrosion resistance
- Tough, chrome vanadium steel shank
- Cushioned rubber grip

Description	For Screw Sizes	Cat. No.
#0 x 4 in.	3, 4	<b>35-690</b>
#1 x 4 in.	5, 6, 7	<b>35-691</b>
#1 x 8 in.	5, 6, 7	<b>35-692</b>
#2 x 4 in.	8, 9, 10	<b>35-693</b>
#2 x 8 in.	8, 9, 10	<b>35-694</b>
#3 x 4 in.	12, 14	<b>35-695</b>
#3 x 8 in.	12, 14	<b>35-696</b>

### Awl



- Heavy-duty construction for piercing, punching and scribing
- Identification mark on end
- Cushioned rubber grip

Description	Blade Length	Total Length	Cat. No.
Awl	3 in.	6-3/4 in.	<b>35-202</b>

### Screw-Holding

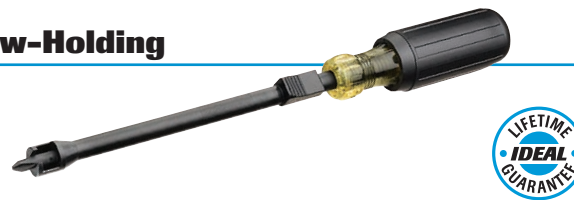

- Holds screw when collar is extended
- Holds screw in place when installing in hard-to-reach locations
- Tough, chrome vanadium steel shank and comfort grip handle

Description	Blade Length	Total Length	Cat. No.
3/16 in. Slotted	6 in.	10 in.	<b>35-406</b>
#2 Phillips	7 in.	11 in.	<b>35-404</b>

### Nutmaster® Nutdrivers

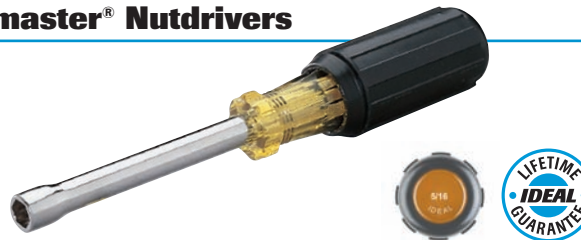

- Long, hollow shank handles longer bolts
- Identification and color coding on ends
- Nickel/chrome plated to resist rust and corrosion
- Cushioned rubber grips
- Models 35-292 and 35-295 fit Twister® Wire Connectors

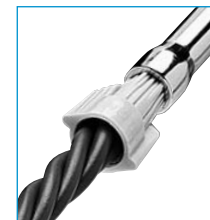

Description	Shaft Length	Color	Cat. No.
3/16 in.	3-1/4 in.	Black	<b>35-290</b>
1/4 in.	3-1/4 in.	Red	<b>35-291</b>
5/16 in.	3-1/4 in.	Yellow	<b>35-292</b>
11/32 in.	3-1/4 in.	Green	<b>35-293</b>
3/8 in.	3-1/4 in.	Blue	<b>35-294</b>
7/16 in.	4 in.	Brown	<b>35-295</b>
1/2 in.	4 in.	Red	<b>35-296</b>



# Tools and Totes

## Slim Electronics

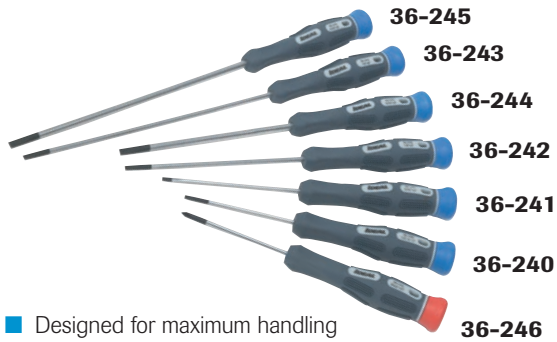

- Designed for maximum handling comfort when working in tight areas
- Tough, chrome vanadium steel shank
- Phosphate tip for longer wear life
- Rotating cap for optimum control for precise centering
- Color-coded cap for easy identification



Description	Style	Blade Length	Cat. No.
3/32 in.	Cabinet Tip	2-1/2 in.	<b>36-240</b>
3/32 in.	Cabinet Tip	3 in.	<b>36-241</b>
1/8 in.	Cabinet Tip	4 in.	<b>36-242</b>
1/8 in.	Cabinet Tip	6 in.	<b>36-243</b>
5/32 in.	Cabinet Tip	4 in.	<b>36-244</b>
5/32 in.	Cabinet Tip	6 in.	<b>36-245</b>
#0 - 1/8 in.	Phillips Head	2-1/2 in.	<b>36-246</b>
7-Piece Set includes one each of 36-240 thru 36-246			<b>36-248</b>
4-Piece Set includes one each of 36-240, -241, -242 & -246			<b>36-249</b>

## 7-Piece Nutdriver Set



- Includes:**
- 3/16 in. x 3-1/4 in.
  - 1/4 in. x 3-1/4 in.
  - 5/16 in. x 3-1/4 in.
  - 11/32 in. x 3-1/4 in.
  - 3/8 in. x 3-1/4 in.
  - 7/16 in. x 4 in.



Description	Cat. No.
7-Piece Nutdriver Set	<b>35-299</b>

## 10-in-1 Screwdriver/Nutdriver

- Includes 1/4 in. slotted, #2 Phillips, 3/16 in. slotted, #1 Phillips, #1 & #2 square recess, #15 and #10 Torx® and 5/16 in. & 1/4 in. Nutdriver
- Cushion grip for comfort and performance



Description	Cat. No.
10-in-1 Screwdriver/Nutdriver	<b>35-910</b>

### Replacement Bits (for 10-in-1 Screwdriver)

Description	Cat. No.
1/4 in. slotted - #2 Phillips (2/pack)	<b>35-940</b>
3/16 in. slotted - #1 Phillips (2/pack)	<b>35-941</b>
#1 & #2 Square Recess (2/pack)	<b>35-942</b>
#15 & #10 Torx® (2/pack)	<b>35-943</b>

*Torx® is a trademark of Camcar division of Textron, Inc.*

## 5-in-1 Screwdriver/Nutdriver

- Contains: 5/16 in. Nutdriver, #1 Phillips, #2 Phillips, 9/32 in. slotted and 3/16 in. slotted
- Cushion grip for performance and comfort



Description	Cat. No.
5-in-1 Screwdriver/Nutdriver	<b>35-905</b>

### Replacement Bits (for 5-in-1 Screwdriver)

Description	Cat. No.
#1 Phillips - 3/16 in. slotted	<b>LA-4123</b>
#2 Phillips - 9/32 in. slotted	<b>LA-4124</b>

## Recessed Light Kit

- All the tools needed to install recessed lights
- Long spring tool easily installs and removes spring
- Compact nutdriver is 2-1/4 in. - providing added clearance in recess lighting
- Cushion grip for added comfort

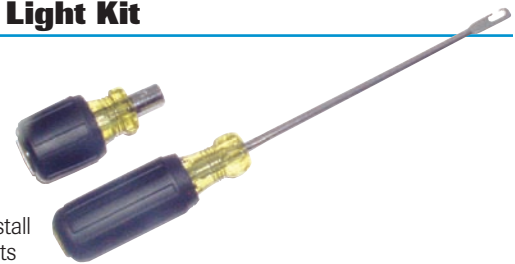

Description	Cat. No.
Recessed Light Kit	<b>35-698</b>

Hand Tools



## PowerBlade™ Cable Cutter

(Drill not included)



Cable Cutters

- Extremely versatile: fits almost any drill (12V minimum)
- Cuts up to 750 MCM hard - drawn copper, 1000 MCM aluminum\*
- Heavy-duty gears and specially hardened blades for professional quality
- Rounded blade design minimizes cable distortion during cutting
- No need to mess with battery packs or special chargers; this tool works with the drill you already carry!



(Folding handle for storage.)

Description	Cat. No.
PowerBlade™ Cable Cutter	<b>35-078</b>
PowerBlade™ Replacement Handle	<b>K-8947R</b>
PowerBlade™ Replacement Blades (pair)	<b>K-8906R</b>
PowerBlade™ Replacement Torque Arm Assembly	<b>K-8909</b>
PowerBlade™ Replacement Carrying Case	<b>K-8926</b>

\*Max. Jaw Opening - 2 in. Not for cutting steel or ASCR.

## Long-Arm Cable Cutters

- High strength forged blades for ultimate durability
- Precision-ground jaws make clean cuts with minimal cable distortion
- Replaceable blades
- For copper and aluminum only. Not designed for steel or ASCR.



Description	Length	Cat. No.
250 MCM Long-Arm Cable Cutter	14 in.	<b>35-031</b>
500 MCM Long-Arm Cable Cutter	22 in.	<b>35-032</b>
1000 MCM Long-Arm Cable Cutter	32 in.	<b>35-033</b>
Replacement Head – 250 MCM (for 35-031)	—	<b>35-031B</b>
Replacement Head – 500 MCM (for 35-032)	—	<b>35-032B</b>
Replacement Head – 1000 MCM (for 35-033)	—	<b>35-033B</b>

**CAUTION: Comfort-grip handles are not designed for protection against electrical shock. Do not use on live circuits.**

## Ratcheting Cable Cutter

- Cuts hard drawn copper up to 400 KCMIL (MCM) and soft copper, aluminum and multiple conductor cable up to 600 KCMIL (MCM)
- Hardened steel blades ensure consistent cuts and long-term durability
- Rounded blade design minimizes cable distortion during cutting
- Quick release mechanism simplifies blade back-out
- Locking mechanism keeps handles closed for easy storage



Description	Cat. No.
400 KCMIL (MCM) Ratcheting Cable Cutter*	<b>35-056</b>
Replacement blade (moveable side only)	<b>35-085</b>

\*Max. Jaw Opening - 1.375 in. Not for cutting steel or ASCR.

## Ratcheting Cable Cutter

- 750 KCMIL Ratcheting Cable Cutter is designed to cut 750 KCMIL (MCM) and smaller hard-drawn copper and aluminum cables
- Hardened steel blades ensure consistent cuts and long-term durability
- Rounded blade design minimizes cable distortion during cutting
- Quick release mechanism simplifies blade back-out
- Locking mechanism keeps handles closed for easy storage
- Molded-in foot provides stability and leverage when making multiple cuts



Description	Cat. No.
750 KCMIL (MCM) Ratcheting Cable Cutter*	<b>35-053</b>
Replacement blade (moveable side only)	<b>35-057</b>

\*Max. Jaw Opening - 2 in. Not for cutting steel or ASCR.

## Telco Ratcheting Cable Cutters

- Telco Ratcheting Cable Cutter jaw cuts up to 2,700 pair telephone cable and Stalpath® type communications cable
- Hardened steel blades ensure consistent cuts and long-term durability
- Rounded blade design minimizes cable distortion during cutting
- Quick release mechanism simplifies blade back-out
- Locking mechanism keeps handles closed for easy storage
- Molded-in foot provides stability and leverage when making multiple cuts



Description	Cat. No.
Telco Ratcheting Cable Cutter*	<b>35-055</b>
Replacement blade (moveable side only)	<b>35-054</b>

\*Max. Jaw Opening - 3 in. Not for cutting steel or ASCR.

# Tools and Totes



## Sir Nickless Cutter

TO SEVER AND PROTECT ARMORED CABLE



- Handles all common BX, MCAP, MC and Flex cables
- Blade cuts armor without damage to internal conductors
- Splices cleanly through casings with only a few turns
- Handle knob stores up to six replacement blades

Description	Cat. No.
Replacement blades (5/pack)	<b>35-781</b>
Rotary Armored Cable Cutter	<b>35-782</b>

## Mechanical Indentor and Crimp Tool

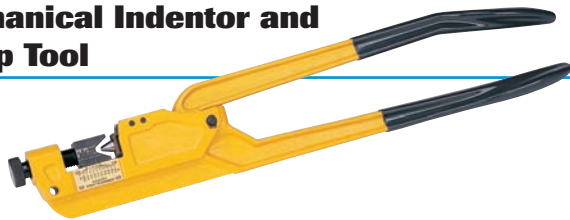

- Use with aluminum (6 AWG to 4/0) and copper (8 AWG to 250 KCMIL) wires
- Adjustable crimping nests with clearly marked gauges
- Lightweight and easy to operate
- Rugged cast steel construction for long-term durability
- Connections are UL Listed when using this tool with IDEAL Non-Insulated Terminals (#8 - #4 AWG).

Description	Cat. No.
Mechanical Indentor	<b>88-843</b>

## Heavy-Duty Crimp Tool

- Crimp nests for 2, 4, 6 or 8 AWG and 8-38 mm<sup>2</sup> uninsulated terminals
- Rotating crimp nests eliminate costly die changes
- Decimal and metric wire sizes clearly marked on each crimp nest
- Comfort-grip handles for a secure grip
- Connections are UL Listed when using this tool with IDEAL Non-Insulated Terminals (#8 - #4 AWG).



Description	Cat. No.
Heavy-Duty Crimp Tool	<b>83-005</b>

## Crimp Tool

- Crimps all IDEAL crimp sleeves
- Excellent leverage for right-angle, double-indent crimps
- Cuts and twists wire
- Vinyl-coated handles provide a solid, comfortable grip

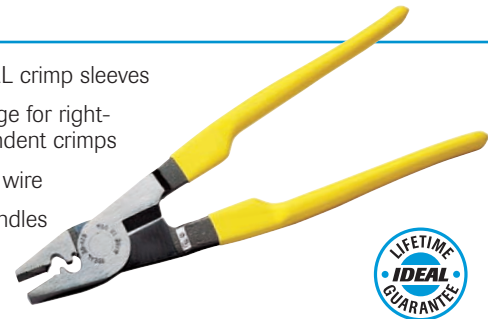

Description	Cat. No.
Crimp Tool - 10-1/4 in.	<b>30-425</b>

## Buchanan Construction Products Four-Way Crimp Tool

- Patented design ensures even compression and reliable connections
- Spring-loaded, cam-actuated plungers
- Fingertip adjustment for different connector sizes

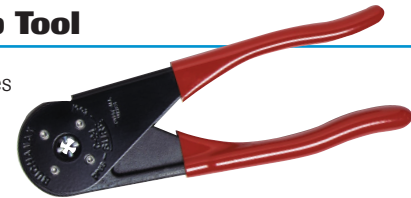

Description	Cat. No.
Four-Way Crimp Tool	<b>C-24</b>

## Ratchet Crimp Tool

- Crimps insulated or bare terminals and splices on 10 - 22 AWG wire
- Ratchet action prevents release prior to crimp connection – helps ensure uniform crimps
- Vinyl-coated handles provide a solid, comfortable grip



Description	Cat. No.
Ratchet Crimp Tool	<b>83-001</b>

Cutter/Crimp Tools



### Adjustable Wrenches



- Narrow profile head reaches into tight spaces
- Tight tolerance on thumbscrew won't loosen or wobble with use
- Extra wide jaw capacity with standard and metric markings
- Lightweight, non-conductive handle (not insulated)



Description	Jaw Capacity	Cat. No.
8 in. Adjustable Wrench	1-1/8 in.	35-020
10 in. Adjustable Wrench	1-5/16 in.	35-021

### 6-in-1 Twist-a-Nut™ Tapping Tools



- Forms new threads, re-forms burred threads and cleans out obstructions
- Reversible, high-carbon tap with three clearly marked thread sizes on each end
- Handle is interchangeable with 7-in-1 Screwdriver (#35-908) and Conduit Deburrer (#35-083)

Description	Cat. No.
6-in-1 Twist-a-Nut™ Tap Tool (includes 6-32, 8-32 & 10-32, 10-24, 12-24 & 1/4-20 taps)	35-923

### Triple-Tap Tool

- Cleans and chases burred threads
- Taps three hole sizes



Description	Cat. No.
Triple Tap Tool (includes 10/24, 8/32, & 6/32 taps)	35-411
Triple Tap Tool (includes 10/32, 8/32, & 6/32 taps)	35-412

### Replacement Taps (for 35-923, 35-411 and 35-412)

Thread Sizes	Replacement Tap Cat. No.
10/24, 8/32, & 6/32	35-421
10/32, 8/32, & 6/32	35-422
10/24, 12/24 & 1/4-20	35-423
6-32, 8-32 & 10-32 on one side, 10-24, 12-24 & 1/4-20 on the other side	35-922

### IDEAL Wipes™ The Multi-Purpose Towel

- Pre-moistened wipes require no water
- Cleans dirt, grease, lube and grime
- Durable fabric scrubs without tearing
- Infused with natural hand moisturizers and Vitamin E
- Orange citrus scent



Description	Qty.	Cat. No.
IDEAL Wipes™, 12 in. x 9 in.	82/can	38-500

### Forged-Steel Handled Hammer



- One-piece drop-forged, tempered-steel polished head and handle
- Long, straight claws simplify removal of electrical fixtures
- Comfortable, perforated anti-vibe grips
- Elongated neck for hitting inside boxes

Description	Cat. No.
18 oz. x 12-1/2 in. Electrician's Fiberglass-handled Hammer	35-210

### Electric Engraving Tools

- Low-cost, industrial-quality marker quickly and easily engraves metal, glass, stone, ceramics, plastics, hard rubber, wood and many other hard materials
- Unique design reduces bouncing and provides smooth, easy writing
- Operates at 7,200 strokes per minute
- Stroke adjusts to vary depth of mark
- Includes carbide-tipped point for normal markings
- Diamond point available for engraving extra-hard materials (50 to 64 Rockwell, scale C)



Description	Cat. No.
Engraver w/carbide-tipped point — 120V, 60 Hz	11-111
Engraver w/carbide-tipped point & 3-conductor grounded cord & plug — 120V, 60 Hz	11-113
Carbide-tipped replacement point	11-200
Diamond replacement point	11-201

Hand Tools



# Tools and Totes

## Automatic Blade Lock Measuring Tape



- Blade automatically stays out when extended
- Push button for smooth blade retraction
- Comfortable, shock-resistant rubber grip

Description	Cat. No.
Auto-Lock™ Tape Measure - 25 ft.	35-242

## Magnetic-Tip Measuring Tape



- Strong magnetic tip for one person measurement
- Durable nylon coated blade
- Full rubber jacket protects case

Description	Cat. No.
Mag-Tape™ Tape Measure - 25 ft.	35-238

## Torpedo Level

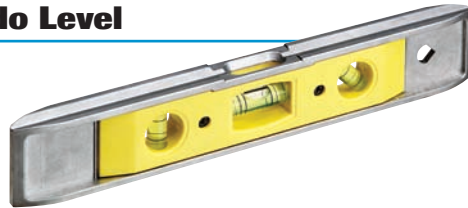

- 9 in. aluminum frame with magnetic and V-grooved edges
- White windows provide easy reading of plumb level and 45° mitre in dim lighting

Description	Cat. No.
9 in. Torpedo Level	35-205

## Hex-Key Sets



- 8650 steel construction
- Dual-durometer, slip-resistant grip



Description	Cat. No.
4 in. handle w/nine 3-in. keys (5/64 in., 3/32 in., 7/64 in., 1/8 in., 9/64 in., 5/32 in., 3/16 in., 7/32 in. & 1/4 in.)	35-146
5-1/4 in. handle w/five 5-in. keys (3/16 in., 7/32 in., 1/4 in., 5/16 in. & 3/8 in.)	35-147

## Utility Knife



- Quick-change retractable blade system – no disassembly required
- Built in pull-line cutter
- Includes three blades in storage compartment

Description	Cat. No.
Utility Knife	35-300
Replacement blades – Universal (10/pack)	35-301

## Pocket Knives



- 2-1/4 in. blade locks in position
- High-carbon stainless steel blade construction for extra strength and durability
- Durable Buyrate® non-slip handle
- Brass liners

Description	Cat. No.
Electrician's Knife w/spearpoint and screwdriver blade	35-285
Hawkbill Knife w/curved blade	35-286
Lineman's Jack Knife w/sheepfoot blade	35-287

Hand Tools



## Tool Kits featuring **LASERedge™** Pliers

### 17-Piece Set - #35-809



#### Set Includes:

- Four LASERedge™ Pliers with Smart-Grip™ Handles (#35-3012 – 9-1/4" Linesman w/fish tape puller, #35-3038 – 8" Long Nose, #35-3430 – 10" Tongue and Groove, #35-3052 – 9-1/2" Cable Cutter)
- #45-915 – Kinetic™ Reflex™ T<sup>®</sup>-Stripper Wire Stripper
- #35-908 – 7-in-1 Twist-A-Nut™ Screwdriver
- #Five Cushion Grip Screwdrivers (#35-193 – #1 x 3 Phillips, #35-194 – #2 x 4 Phillips, #35-186 – 3/16" x 6 Slotted Cabinet Tip, #35-164 – 1/4" x 4 Slotted round shank, #35-406 – 3/16" x 6 Screw holding slotted)
- #35-286 – Hawkbill Knife
- #35-210 – Electrician's Hammer
- #35-242 – 25' Auto-Lock™ Tape Measure
- #35-205 – Torpedo Level
- #61-086 – Vol-Con® XL Voltage/Continuity Tester
- #35-975 – Tuff-Tote™ Premium Leather Tool Carrier

### 13-Piece Set - #35-790



#### Set Includes:

- Three LASERedge™ Pliers with Smart-Grip™ handles (#35-3012 – 9-1/4" Linesman w/fish tape puller, #35-3038 – 8" Long Nose, #35-3430 – 10" Tongue and Groove)
- #45-915 – Kinetic™ Reflex™ T<sup>®</sup>-Stripper Wire Stripper
- Four Cushion Grip Screwdrivers (#35-193 – #1 x 3 Phillips, #35-194 – #2 x 4 Phillips, #35-186 – 3/16" x 4 Slotted Cabinet Tip, #35-164 – 1/4" x 4 Slotted round shank)
- #35-242 – 25' Auto-Lock™ Tape Measure
- #35-286 – Hawkbill Knife
- #34-002 – Medium Size Fuse Puller
- #35-205 – Torpedo Level
- #35-462 – Journeyman Electrician's Tote™

### 16-Piece Set - #35-800

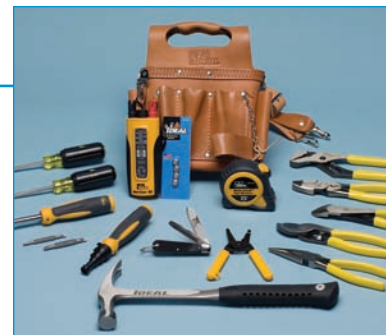

#### Set Includes:

- Five LASERedge Pliers with dipped grips (#30-430 – 9-1/4" Linesman w/crimper, #35-029 – 8" Offset Diagonal, #35-038 – 8" Long Nose, #35-430 – 10" Tongue and Groove, #35-052 – 2/0 Cable Cutter)
- #45-120 – Premium T<sup>®</sup>-5 T<sup>®</sup>-Stripper Wire Stripper
- #35-908 – 7-in-1 Twist-A-Nut™ Screwdriver
- Two Cushion Grip Screwdrivers (#35-194 – #2 x 4 Phillips, #35-164 – 1/4 x 4 Slotted round shank)
- #35-083 – Twist-A-Nut™ Conduit Deburring Tool
- #35-210 – Electrician's Hammer
- #35-242 – 25' Auto-Lock™ Tape Measure
- #35-285 – Electrician's Knife
- #61-086 – Vol-Con® XL Voltage/Continuity Tester
- #61-201 – Replacement battery
- #35-311 – Tuff-Tote™ Leather Tool Pouch

### 16-Piece Set - #35-808



#### Set Includes:

- Four LASERedge Pliers with dipped grips (#35-012 – 9-1/4" Linesman w/fish tape puller, #35-038 – 8" Long Nose, #35-430 – 10" Tongue and Groove, #35-012 – 9-1/2" Cable Cutter)
- #45-415 – Reflex™ T<sup>®</sup>-5 T<sup>®</sup>-Stripper Wire Stripper
- #30-428 – Combo Crimp/Strip Tool
- Four Cushion Grip Screwdrivers (#35-193 – #1 x 3 Phillips, #35-194 – #2 x 4 Phillips, #35-186 – 3/16" x 6 Slotted Cabinet Tip, #35-164 – 1/4" x 4 Slotted round shank)
- #35-210 – Electrician's Hammer
- #35-242 – 25' Auto-Lock™ Tape Measure
- #34-002 – Pocket Fuse Puller
- #35-286 – Hawkbill knife
- #35-261 – Ergonomic Hacksaw
- #35-427 – 18" Large Mouth Bag

## Tools and Totes

### Tool Kits featuring **LASERedge™** Pliers

#### 12-Piece Set - #35-805



##### Set Includes:

- Four LASERedge™ Pliers with dipped grip handles (#35-012 – 9-1/4" Linesman w/fish tape puller, #35-028 – 8" Diagonal, #35-038 – 8" Long Nose, #35-430 – 10" Tongue and Groove)
- #45-120 – Premium T<sup>®</sup>-5 T<sup>®</sup>-Stripper Wire Stripper
- Four Cushion Grip Screwdrivers (#35-193 – #1 x 3 Phillips, #35-194 – #2 x 4 Phillips, #35-186 – 3/16" x 4 Slotted Cabinet Tip, #35-164 – 1/4" x 4 Heavy-Duty Slotted round shank)
- #35-242 – 25' Auto-Lock™ Tape Measure
- #10-466 – Electrician's Leather Tool Pouch
- #10-398 – Web Belt

#### 6-Piece Set - #35-794



##### Set Includes:

- One LASERedge Plier with dipped grip handles (#30-430 – 9-1/4" Linesman w/crimper)
- #45-120 – Premium T<sup>®</sup>-5 T<sup>®</sup>-Stripper Wire Stripper
- #35-908 – 7-in-1 Twist-a-Nut™ Screwdriver
- #35-242 – 25' Auto-Lock™ Tape Measure
- #35-300 – Utility Knife
- #35-505 – Pocket Pal™ Tool Holster

### Tool Kits featuring **WireMan™** Pliers

#### 12-Piece Set - #35-5805

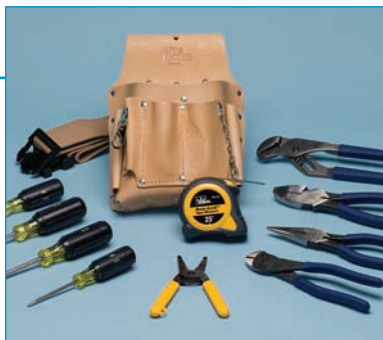

##### Set Includes:

- Four WireMan™ Pliers with dipped grip handles (#35-5012 – 9-1/4" Linesman, #35-5028 – 8" Diagonal, #35-5038 – 8" Long Nose, #35-5430 – 10" Tongue and Groove)
- #45-120 – Premium T<sup>®</sup>-5 T<sup>®</sup>-Stripper Wire Stripper
- Four Cushion Grip Screwdrivers (#35-193 – #1 x 3 Phillips, #35-194 – #2 x 4 Phillips, #35-184 – 3/16" x 4 Slotted Cabinet Tip, #35-164 – 1/4" x 4 Slotted round shank)
- #25' Auto-Lock™ Tape Measure
- #10-466 – Electrician's Leather Tool Pouch
- #10-398 – Web Belt

#### 5-Piece Set - 35-5792



##### Set Includes:

- One WireMan™ Plier with dipped grip handles (#30-5430 – 9-1/4" Linesman w/crimper)
- #45-120 – T<sup>®</sup>-5 T<sup>®</sup>-Stripper Wire Stripper
- Two Screwdrivers (#35-194 – #2 x 4 Phillips, #35-186 – 3/16" x 4 Slotted Cabinet Tip)
- #35-505 – Pocket Pal™ Tool Holster



Carriers/Pouches

### Premium Leather Line

Top of the line tool carriers are handcrafted from heavy, top-grain cowhide and slow tanned in natural oils to enhance the leather's inherent strength. Each bag is hand waxed for lasting protection against stains and moisture and is warranted for life. Natural or black leather – your choice.



### Standard Leather Line

Leather that stands up to the job like no other material, these tool carriers are constructed of top-grain, natural cowhide and tanned for added strength and durability. Watch their color age to a deep tan over the years.



### Fabric Line

Durable, lightweight, portable tool totes in rugged nylon polyester or heavyweight canvas provide the perfect tool storage. Convenient pockets mean easy access; inner compartments keep your tools organized and safe when not in use.



### Tuff-Tote™ Ultimate Tool Carriers



- Eight-inch square tool carrier features two divided inside compartments with six screwdriver loops each, one large center compartment, four outside pockets and eight outside tool loops
- Exclusive leather-wrapped grab handle for carrying comfort
- Removable shoulder strap helps relieve lower back strain
- Unique stand-alone design keeps tools standing upright for easy identification and access
- Rust-resistant, plated-steel hardware and heavy, lock-stitched nylon thread for long-term durability
- Oil and moisture-resistant reinforced bottom

Description	Cat. No.
Premium Leather Carrier w/shoulder strap	35-975
Premium Black Leather Carrier w/shoulder strap	35-975BLK
Standard Leather Carrier w/shoulder strap	35-325

### Tuff-Tote™ Tool Carriers



- Convenient 6 in. x 8 in. tool carrier with four center screwdriver slots, two interior compartments, two divided outside pockets and four outside tool loops
- Exclusive leather grab handle for carrying comfort
- Removable shoulder strap helps relieve lower back strain
- Unique stand-alone design keeps tools standing upright for easy identification and access
- Rust-resistant, plated-steel hardware and heavy, lock-stitched nylon thread for long-term durability
- Oil and moisture-resistant reinforced bottom

Description	Cat. No.
Premium Leather Carrier w/shoulder strap	35-969
Premium Black Leather Carrier w/shoulder strap	35-969BLK

### Tuff-Tote™ Tool Pouches



- Eight-pocket, belt-mounted pouch features large utility compartment with two dividers and six screwdriver loops, seven outside pockets, release snaps and tape chain
- Exclusive leather grab handle for carrying comfort
- Removable shoulder strap helps relieve lower back strain
- Rust-resistant, plated-steel hardware and heavy, lock-stitched nylon thread for long-term durability
- Tunnel belt loop accommodates belts up to 2-1/4 in. wide

Description	Cat. No.
Premium Leather Pouch w/shoulder strap	35-950
Premium Black Leather Pouch w/shoulder strap	35-950BLK



# Tools and Totes

## Electrician's Tool Pouch

- Seven-pocket tool pouch
- Full length belt tunnel
- Chain tape lanyard



Description	Cat. No.
Electrician's Tool Pouch	10-466

## Hip Holster Tool Pouches

- Compact, multi-pocket holsters
- Heavy-duty leather construction
- Riveted corners for long life
- Tape measure holder



Description	Cat. No.
6-Pocket Hip Holster, Black	35-784BLK
3-Pocket Hip Holster, Standard	35-964

## Tuff-Tote™ Tester Pouches

- Fits most hand-held testers
- Easy-access top
- Convenient belt strap



Note: Tester sold separately

Description	Cat. No.
Premium Leather Pouch w/belt strap	35-956
Premium Black Leather Pouch w/belt strap	35-956BLK
Standard Leather Pouch w/belt strap	35-339

## Hammer Holder

- Heavy-duty leather construction
- Riveted steel hammer loop
- Fits on all sizes of tool belts



Description	Cat. No.
Hammer Holder	10-399

## Shoulder Straps



- Nickel-plated hardware for long-term durability and corrosion resistance
- 2-in. wide shoulder pad for added comfort

Description	Cat. No.
Premium Leather Strap	35-965
Premium Black Leather Strap	35-965BLK
Standard Leather Strap	35-338

## Belts



- Nickel-plated hardware for long-term durability and corrosion resistance

Description	Cat. No.
Premium Leather Belt – 2 in. x 48 in.	35-995
Premium Black Leather Belt – 2 in. x 48 in.	35-995BLK
Standard Leather Belt – 1-3/4 in. x 46 in.	35-316
Web Belt	10-398

Hand Tool Pouches



Hand Tool Pouches

### Pocket Pal™ Tool Holster

- Protects pocket from sharp tools
- Doubles tool carrying capacity
- Can be worn in pocket or on belt



Description	Cat. No.
Pocket Pal™ Tool Holster	35-505

Note: Tools sold separately.

### Belt Bag™ Supplies Pouch

- Holds wire connectors, staples, and other supplies ready for use on the job
- Easy access opening closes automatically to keep supplies safely retained until needed



Description	Cat. No.
Belt Bag™ Supplies Pouch	35-405

### Zipper Pouches



- Durable, water resistant material
- Heavy duty, self-repairing zippers

Description	Cat. No.
Zipper Pouch, 10-1/2 in. long	35-402
Zipper Pouch, 12-1/2 in. long	35-403

### Divider Pouch™ Small Parts Bag

- Designed to provide perfect small parts storage — keeps parts separate and organized
- Six internally divided 5-in. deep pockets
- Convenient drawstring protects contents from spillage
- Convenient handle loop
- Sized to stack in 5-gallon buckets
- Durable nylon polyester construction



Description	Cat. No.
Divider Pouch™ Small Parts Bag	35-655

Note: Wire Connectors sold separately.

### Bucket Bag Tool Carrier

- 11-1/2 in. deep bag fits over the rim of a standard 5-gallon bucket
- Forty-three convenient pockets — 36 pleated outside and inside pockets
- Rugged nylon polyester construction



Description	Cat. No.
Bucket Bag Tool Carrier	35-665

Note: Tools sold separately.

### Supplies Apron



- Two pockets for connectors and fasteners, each 8 in. x 15 in.
- Natural duck construction

Description	Cat. No.
Supplies Apron	35-474

# Tools and Totes

## Large Mouth Bags



- Top opens completely for easy access to large tools – reinforced to hold itself open
- Measures 9 in. wide x 12 in. deep with outside and inside pockets for convenient hand tool storage
- Rugged zipper closure helps prevent tool loss
- Removable shoulder strap
- Durable multi-ply construction

Description	Cat. No.
Large Mouth Bag – 13 in. long	35-410
Large Mouth Bag – 16 in. long	35-418
Large Mouth Bag – 18 in. long	35-427

Note: Tools sold separately.

## Journeyman Electrician's Tote™

- Compact and versatile design
- Carry as a hand-tote, shoulder-tote or tool-belt
- Includes removable shoulder strap and belt
- Durable multi-ply construction



Description	Cat. No.
Journeyman Electrician's Tote™	35-462

## Master Electrician's Tote™

- Spacious and durable design
- Organizes and displays tools for fast access
- Includes removable shoulder strap
- Durable multi-ply construction



Description	Cat. No.
Master Electrician's Tote™	35-441

## Mechanic's Tool Bag



- Eight narrow inside pockets designed to hold small tools
- Two side pockets with closeable snaps for large tools or loose items
- Double inside liner and rigid bottom prevent bag distortion
- Durable nylon polyester construction

Description	Cat. No.
Mechanic's Tool Bag	35-535

Note: Tools sold separately.

Bags/Totes



## Insulated Tools

The IDEAL insulated tool line creates a perfect blend of safety, comfort and precision functionality. Each tool features double insulated Santoprene® handles with a soft, easy-to-grip outer surface. In addition to the ergonomic qualities found in our tools, the insulated coating process acts as an 'at-a-glance' safety check. If the orange outer coating reveals any of the inner yellow surface, an electrician will know that this tool needs to be replaced.

### Tools feature:

- First UL tested and classified insulated pliers
- Each one designed and tested to meet ASTM F1505-01, EN DIN, and IEC 60 900 test standards
- Individually tested and VDE certified to 1000V AC (1500V DC)
- Meets OSHA requirements for insulated tools

Insulated Hand Tools

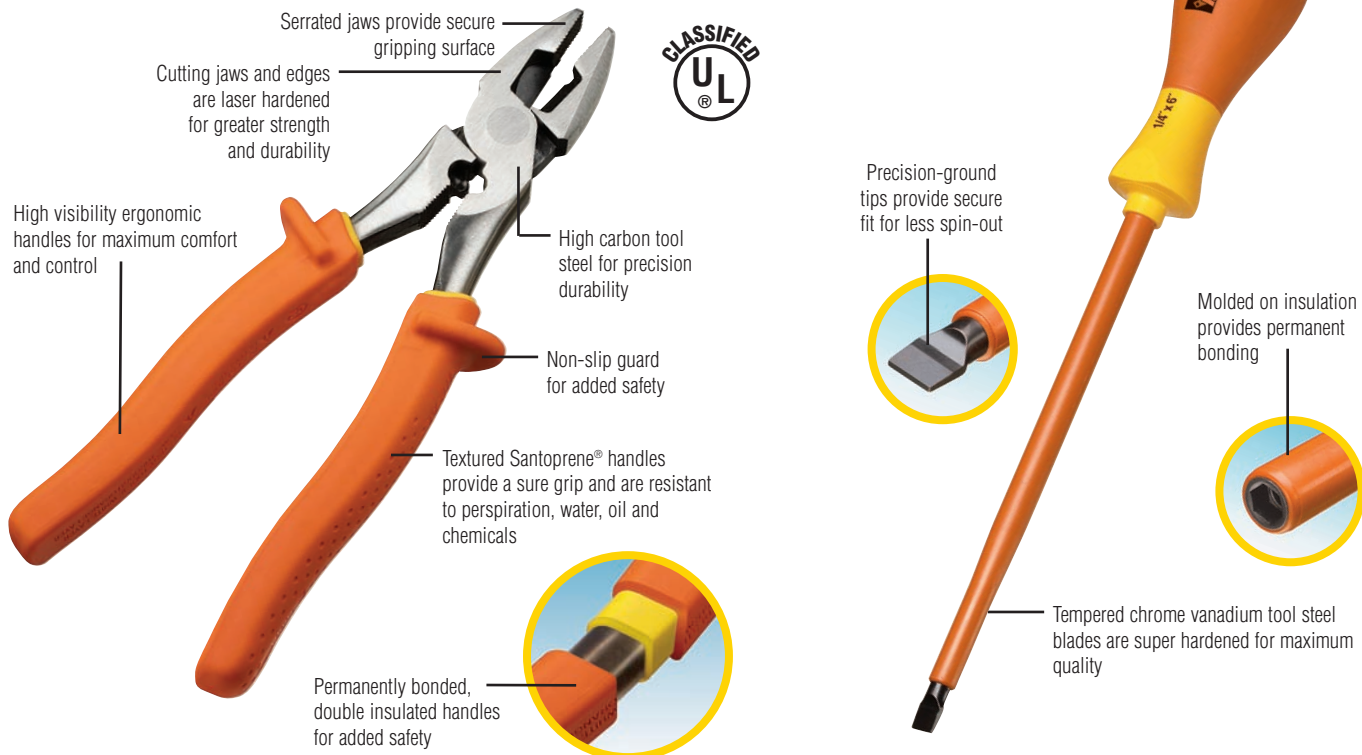

### Warning

Whenever possible, always de-energize lines and equipment prior to working on or around them. 1000V insulated tools are designed only to reduce the chance of injury where the tool may make contact with an energized source. Work around energized circuits should only be done when absolutely necessary and only by qualified technicians. Property damage, personal injury or death may result if the following warnings are not heeded:

- Do not use any insulated tool if the insulation cracks, breaks or becomes damaged in any way. Destroy all dual-layer tools if the inner yellow layer shows through the orange outer layer.
- Do not touch the uninsulated portion of an insulated tool or any conductive object when either might contact an energized source.
- Tools must be kept clean and dry for proper insulating properties.
- Always inspect insulated tools before use.
- Use additional protection by wearing protective clothing and approved eye protection.
- Always use tools that are specifically designed for the task.
- **These tools meet UL 22PP, ASTM F1505-01 and IEC 60900 standards for insulated tools.**
- **Always follow OSHA 1910 S and NFPA 70E safety requirements when doing electrical work.**

### REGULATIONS

#### Testing:

- Every 1000V insulated tool we sell is individually tested to ensure no failure when subjected to live current.

#### UL and VDE Certification:

Listed below are some of the tests we perform in order to pass certification:

- Tools are immersed in water for 24 hours, then tested under current for 3 minutes to ensure no current leakage or sparkover occurs.
- After being stored for 168 hours at -40° C (-40° F), tools are dropped to ensure no damage from impact.
- After being stored for 168 hours at +70° C (158° F), a tensile load is applied to ensure the grip is firmly bonded to the tool.
- Tools are subjected to flame for 10 seconds to ensure no flammability of the insulating material.

#### OSHA Regulations:

*OSHA 1910.335(a)(2)(i)* When working near exposed energized conductors or circuit parts, **each employee shall use insulated tools** or handling equipment if the tools or handling equipment might make contact with such conductors or parts.

*OSHA 1910.335 (a)(1)(i)* Employees working in areas where there are potential electrical hazards **shall be provided with, and shall use**, electrical protective equipment that is appropriate for the specific parts of the body to be protected and for the work to be performed.

**Make sure you are in compliance by providing and using IDEAL insulated tools!**



## Tools and Totes

### 26-Piece Journeyman Kit - #35-9302



#### Kit Includes:

- Four insulated pliers (#30-9430 – 9-1/4 in. Linesman w/crimper, #35-9029 – 8 in. Offset diagonal, #35-9038 – 8-1/2 in. Long Nose, #35-9430 – 10 in. Tongue and Groove)
- Eight insulated screwdrivers (#35-9321 – 1/8 x 4 in. slotted, 3/16 x 5 in. slotted, #35-9323 – 1/4 x 6 in. slotted, #35-9324 – 5/16 x 7 in. slotted, #35-9325 – 3/8 x 8 in. slotted, #35-9310 – #1 x 3 Phillips, #35-9311 – #2 x 4 in. Phillips, #35-9312 – #3 x 6 in. Phillips)
- Six insulated nutdrivers (#35-9330 – 3/16 x 5 in., #35-9331 – 1/4 x 5 in., #35-9332 – 5/16 x 5 in., #35-9333 – 3/8 x 5 in., #35-9334 – 7/16 x 5 in., #35-9335 – 1/2 x 5 in.)
- #35-9052 – 9-1/2 in. insulated High-Leverage Cable Cutter
- #30-9429 – 9-3/4 in. insulated Multi-Crimp Tool
- #45-9615 – Insulated Reflex™ Super T®-Stripper Wire Stripper
- #45-9120 – Insulated Wire Stripper Cutter
- #35-9340 – Insulated Electrician's Skinning Knife
- #61-063 – Volt-Sensor® NCV Tester
- #34-002 – 7-1/2 in. Non-Conductive Fuse Puller
- #35-9352 – Heavy-Duty Soft Tool Case



Insulated Hand Tool Kits

### 18-Piece Standard Kit - #35-9301



#### Kit Includes:

- Four insulated pliers (#30-9430 – 9-1/4 in. Linesman w/crimper, #35-9029 – 8 in. Offset diagonal, #35-9038 – 8-1/2 in. Long Nose, #35-9430 – 10 in. Tongue and Groove)
- Eight insulated screwdrivers (#35-9320 – 1/8 x 4 in. slotted, #35-9321 – 3/16 x 5 in. slotted, #35-9323 – 1/4 x 6 in. slotted, #35-9324 – 5/16 x 7 in. slotted, #35-9325 – 3/8 x 8 in. slotted, #35-9310 – #1 x 3 Phillips, #35-9311 – #2 x 4 in. Phillips, #35-9312 – #3 x 6 in. Phillips)
- #35-9052 – 9-1/2 in. Insulated High-Leverage Cable Cutter
- #45-9615 – Insulated Reflex™ Super T®-Stripper Wire Stripper
- #35-9340 – Insulated Electrician's Skinning Knife
- #61-063 – Volt-Sensor® NCV Tester
- #34-002 – 7-1/2 in. Non-Conductive Fuse Puller
- #35-9351 – Heavy-Duty Soft Tool Case



### 10-Piece Basic Kit - #35-9300



#### Kit Includes:

- Three insulated pliers (#34-9430 – 9-1/4 in. Linesman w/crimper, #35-9029 – 8 in. Offset diagonal, #35-9038 – 8-1/2 in. Long Nose)
- Three insulated screwdrivers (#35-9321 – 3/16 x 5 in. slotted, #35-9323 – 1/4 x 6 in., #35-9311 – #2 x 4 in. Phillips)
- #35-9052 – 9-1/2 in. Insulated High-Leverage Cable Cutter
- #45-9615 – Insulated Reflex™ Super T®-Stripper Wire Stripper
- #34-002 – 7-1/2 in. Non-Conductive Fuse Puller
- #35-9350 – Heavy-Duty Soft Tool Case





## Insulated Pliers

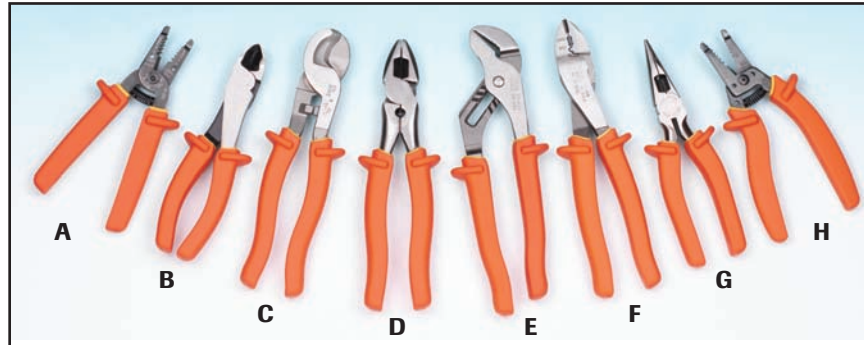

Fig.	Description	Cat. No.
A	Premium T <sup>®</sup> -Stripper Wire Stripper	45-9120
B	8 in. Diagonal Cutting Pliers w/angled head	35-9029
C	9-1/2 in. High-Leverage Cable Cutter	35-9052
D	9-1/4 in. Side Cutting Linesman Pliers	30-9430

Fig.	Description	Cat. No.
E	10 in. Tongue and Groove Pliers	35-9430
F	9-3/4 in. Multi-Crimp Tool	30-9429
G	8-1/2 in. Long-Nose Pliers	35-9038
H	Reflex™ Super T <sup>®</sup> -Stripper Wire Stripper	45-9615

Insulated Hand Tools

## Insulated Screwdrivers



Description	Shaft Length	Cat. No.
#1 Phillips Screwdriver	3 in.	35-9310
#2 Phillips Screwdriver	4 in.	35-9311
#3 Phillips Screwdriver	6 in.	35-9312
1/8 in. Slotted Screwdriver	4 in.	35-9320
3/16 in. Slotted Screwdriver	5 in.	35-9321
7/32 in. Slotted Screwdriver	7 in.	35-9322
1/4 in. Slotted Screwdriver	6 in.	35-9323
5/16 in. Slotted Screwdriver	7 in.	35-9324
3/8 in. Slotted Screwdriver	8 in.	35-9325

Screwdriver Kit	Cat. No.
9-Piece Insulated Screwdriver Kit with hard case (Includes all nine screwdrivers listed above.)	35-9303

## Insulated Nutdrivers



Description	Shaft Length	Cat. No.
3/16 in. Hex Nutdriver	5 in.	35-9330
1/4 in. Hex Nutdriver	5 in.	35-9331
5/16 in. Hex Nutdriver	5 in.	35-9332
3/8 in. Hex Nutdriver	5 in.	35-9333
7/16 in. Hex Nutdriver	5 in.	35-9334
1/2 in. Hex Nutdriver	5 in.	35-9335
9/16 in. Hex Nutdriver	5 in.	35-9336

Nutdriver Kit	Cat. No.
7-Piece Insulated Nutdriver Kit with hard case (Includes all seven Nutdrivers listed above.)	35-9304

## Insulated Knife



Description	Cat. No.
Insulated Electrician's Skinning Knife	35-9340

## Cases



Description	Cat. No.
Soft Zipper Case for Basic Kit (35-9300)	35-9350
Soft Zipper Case for Standard Kit (35-9301)	35-9351
Soft Zipper Case for Journeyman Kit (35-9302)	35-9352
Hard Case for Screwdriver Kit (35-9303) & Nutdriver Kit (35-9304)	35-9353

# Tools and Totes

## Fuse Puller and Test Light

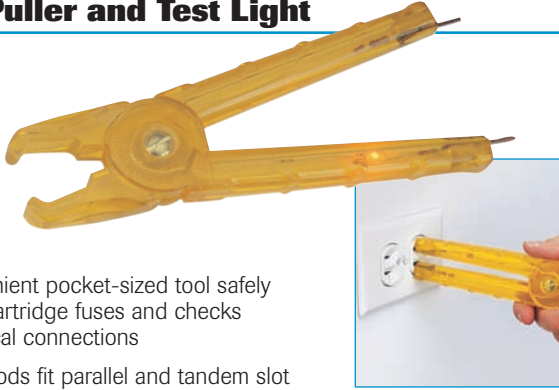

- Convenient pocket-sized tool safely pulls cartridge fuses and checks electrical connections
- Test prods fit parallel and tandem slot receptacles
- Built-in resistors limit current flow to eliminate false indication
- For 9/16 in. to 1 in. fuses
- For use on fuses to 100A/250V and 60A/600V
- Test capacity from 100V to 600V AC/DC

Description	Cat. No.
Fuse Puller & Test Light	<b>34-012</b>

## Safe-T-Grip® Fuse Pullers



- Maximum efficiency and convenience for removing or replacing cartridge-type fuses
- Three sizes handle fuses ranging from 0 to 600A
- Fully insulated, high-dielectric, glass-filled polypropylene construction
- Notched handles provide safe, no-slip grip
- Clearly marked amperage ranges
- Exceed MIL specifications

Description	Cat. No.
Small Puller for 250V, 9/32 in. to 1/2 in. dia. fuses; 5 in. long	<b>34-001</b>
Medium Puller for 0 to 100A/250V & 600V, 1/2 in. to 1 in. dia. fuses; 7-1/2 in. long	<b>34-002</b>
Large Puller for 31 to 600A/250V & 31 to 400A/600V, 3/4 in. to 2-1/2 in. dia. fuses; 11-3/4 in. long	<b>34-003</b>

## Fuse Pullers



- Molded of tough, high-impact nylon for greater strength
- No-slip gripping surface and protective finger stops for added safety

Description	Cat. No.
Small Puller for 0 to 30A/250V, 1/4 in. to 1/2 in. dia. fuses; 5 in. long	<b>34-015</b>
Large Puller for 0 to 100A/250V & 0 to 60A/600V, 9/16 in. to 1 in. dia. fuses; 7-1/4 in. long	<b>34-016</b>

## 1000V Insulated Screw-Holding Screwdriver

- Split blade wedges into screw slot when collar is extended
- Holds screw in place when installing in hard to reach areas
- Easy to start screw when wearing gloves



Description	Cat. No.
1000V Insulated Screw Holding Screwdriver, 3/16 x 6 in. slotted Tip	<b>35-9406</b>

Insulated Hand Tools





## Cutting & Holemaking Tools

**IDEAL cutting tools offer a powerful line-up that includes...**

- **New T.K.O. Carbide-Tipped Hole Cutters provide extreme productivity gains over traditional knockouts, even through stainless steel!**
- **A new line of Bul-Z-Eye™ Self Feed Wood Boring Bits with twin cutting edges and superior construction that cuts smoother and faster holes than the competition**
- **Superior step drill bits that deliver! Dual fluted, titanium nitride coated bits with the NEW split-point self starting feature, deliver faster cuts, improved performance and longer tool life than conventional bits.**
- **Bi-metal reciprocating blades for the toughest applications. Engineered bi-metal blades last up to ten times longer than standard carbon steel blades.**
- **A broad line of flexible drill bits and specialty wood bits that deliver superior performance at any job site.**
- **An expanded range of hacksaws and all-purpose hand saws and blades.**





# Tools and Totes

## Step Drill Bits



35-511



35-512



35-513



35-514



35-515



35-516



35-517

Trust IDEAL step drill bits for precise, repetitive drilling through the toughest materials including brass, carbon steel, cast iron, stainless steel, and more. These tough and reliable tools are constructed with a rugged titanium nitride exterior coating. Each step is gradually blended to ease stepping through hole sizes; reducing the need to keep changing drill bits, which speeds up the fabrication process. Improved Split-Point tip design eliminates the need for a starter hole or punch and delivers three times faster starts, saving valuable time. The double-fluted design provides balanced cuts and cooler operation.



Improved Split-Point design for 3x faster starts

Protective titanium nitride coating

Double-fluted design

Radius-blended, multi-diameter steps

Step Drill Bits

## Electrician's Step Bit Kit

- Durable blow-molded case securely holds and protects bits
- Kit includes four step bits (35-511, 35-513, 35-515 and 35-517)
- Kit provides a solution for every electrical hole size between 1/8 in. and 1-3/8 in.



Drill Diameter Sizes (Inches)	No. of Hole Sizes	Step Increments (Inches)	Step Thickness (Inches)	Shank Dia. (Inches)	Cat. No.
1/8 to 1/2	13	1/32	1/8	1/4	<b>35-511</b>
1/4 to 3/4	9	1/16	1/8	3/8	<b>35-512</b>
1/4 to 7/8	11	1/16	1/16	3/8	<b>35-513</b>
1/2 to 1	8	1/16	1/8	3/8	<b>35-514*</b>
1/4 to 1-1/8	16	1/16	1/16	3/8	<b>35-515</b>
3/16 to 1/2	6	1/16	3/8	1/4	<b>35-516</b>
1/4 to 1-3/8	10	1/32	1/16 to 1/4	3/8	<b>35-517</b>

All shanks are 1 in. length.

\*Requires pilot holes.

Description	Cat. No.
Electrician's Step Bit Kit	<b>35-520</b>



## Carbide Tipped Hole Cutters

Introducing the new TKO™ Carbide Tipped Hole Cutters from IDEAL INDUSTRIES, INC. TKO cutters offer the most efficient and clean cutter replacement for traditional knockouts, by making smooth holes in a fraction of the time at a fraction of the cost. Specifically designed to cut sheet metal, TKO cutters will even cut stainless steel with fine grained, carbide tips. The innovative design includes the exclusive SmoothStart™ replaceable pilot drill, which guides the cutter to the surface, avoiding cutter damage and providing smoother holes. An integral overdrill flange prevents cutter penetration beyond the sheet metal. When it comes to quality, performance and durability, IDEAL is the professional's choice for carbide tipped hole cutters.



**IDEAL TKO™**

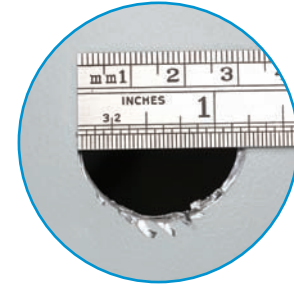

**Competitor**

*IDEAL provides smoother, more precise hole than competitors (holes cut with 1-1/8 in. cutters)*

Carbide Hole Cutters

### Carbide-Tipped Hole Cutters

Hole Size (Inches)	Conduit & Pipe Size (Inches)	Cat. No.
3/4	—	<b>36-300</b>
7/8	1/2	<b>36-301</b>
1	—	<b>36-302</b>
1-1/8	3/4	<b>36-303</b>
1-1/4	—	<b>36-304</b>
1-3/8	1	<b>36-305</b>
1-7/16	—	<b>36-306</b>
1-1/2	—	<b>36-307</b>
1-3/4	1-1/4	<b>36-308</b>
2	1-1/2	<b>36-309</b>
2-1/2	—	<b>36-310</b>



Available in a full range of sizes from 1 in. to 2-1/2 in.

### SmoothStart™ Replacement Pilot Drill

Exclusive! SmoothStart™ pilot guides cutter to surface providing smoother holes and avoiding cutter damage.

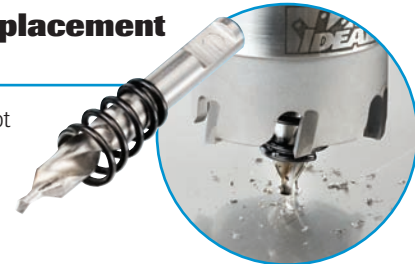

Description	Cat. No.
SmoothStart™ Replacement Pilot Drill	<b>36-312</b>

### 4-Piece Kit

Includes the three most common sizes along with a spare SmoothStart™ pilot bit and a convenient carrying case



Description	Cat. No.
4-Piece Carbide Hole Cutter Kit — Includes SmoothStart™ Replacement Tip, 7/8 in., 1-1/8 in., 1-3/8 in.	<b>36-311</b>

*Integrated overdrill flange prevents penetration beyond the sheet metal.*



# Tools and Totes



## Carbide Tipped Hole Cutters

Carbide tips cut over 200 holes through stainless steel, and out-perform HSS cutters and bi-metal hole saws in sheet steel



Integral arbor provides smoother, more accurate holes than hole saws or two-piece carbide-tipped cutters

Integrated overdrill flange prevents penetration beyond the sheet metal

Ejection spring effortlessly ejects slug

Exclusive SmoothStart™ pilot drill guides cutter

Carbide Hole Cutters

### See how IDEAL TKO can save time...

**Total time using the IDEAL TKO™**  
**30 Seconds**



**Chuck Cutter**

**00:10**

**Drill hole & store**



**00:30**

**Total time using the competitors' knockout tool**  
**More than 6 Minutes**



**Chuck Step Drill**

**00:10**



**Drill Pilot Hole**

**00:30**



**Assemble knockout punch & stud pull**

**02:00**



**Ratchet**

**04:20**



**Slug removed, disassemble & store**

**06:20**



## IRONMAN™ Bi-Metal Hole Saws

IRONMAN™ Bi-metal hole saws from IDEAL INDUSTRIES, INC, with re-engineered bi-metal construction, a thick “flex-free” backing plate, and variable sized teeth, IDEAL IRONMAN™ hole saws will rival the cutting speed and longevity of any in the industry. The bi-metal construction cuts metal, wood and plastics including: tool and stainless steel, nail embedded wood, plywood, and pipe. An extensive list of 51 sizes, effective accessories, and kits are available to meet all your cutting needs. When it comes to quality, performance and durability, IDEAL is the professional’s choice for hole saws.

Hole Saws

New improved solid plate design resists flexing of the new hole saw for clean true holes and added durability

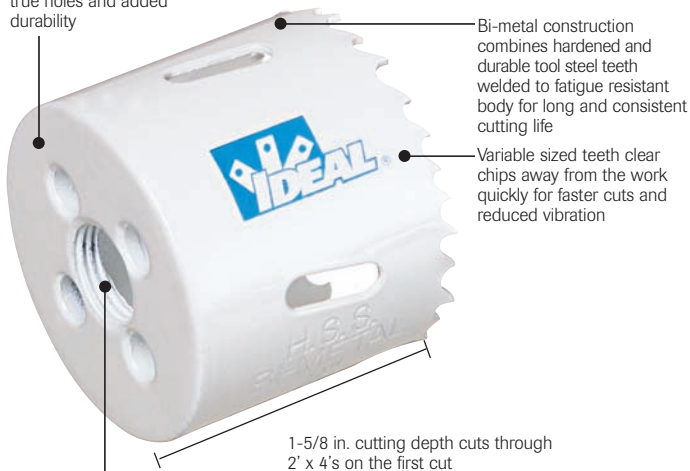

Threads fit all standard arbors

### Hole Saws

- Thicker, **FLEX FREE** backing plate for clean true holes and longer tool life
- Improved bi-metal construction for long life and durability
- Variable pitch tooth geometry for fast cutting and reduced vibration
- Cuts all types of machinable metal including stainless steel, wood, nail embedded wood, plastic and fiberboard



Saw Diameter (Inches)	Pipe Tap Size* (Inches)	Pipe Entrance Size* (Inches)	Cat. No.
<b>Use Arbor No. 35-391, 35-392 or 35-393</b>			
9/16	—	—	<b>35-340</b>
5/8	—	—	<b>35-341</b>
11/16	—	—	<b>35-342</b>
3/4	1/2	3/8	<b>35-343</b>
13/16	—	—	<b>35-344</b>
7/8	3/4	1/2	<b>35-345</b>
15/16	—	—	<b>35-346</b>
1	—	—	<b>35-347</b>
1-1/16	—	—	<b>35-348</b>
1-1/8	1	3/4	<b>35-349</b>
1-3/16	—	—	<b>35-350</b>
<b>Use Arbor No. 35-394, 35-536 or 35-537</b>			
1-1/4	—	—	<b>35-351</b>
1-5/16	—	—	<b>35-352</b>
1-3/8	—	1	<b>35-353</b>
1-7/16	—	—	<b>35-354</b>
1-1/2	1-1/4	—	<b>35-355</b>
1-9/16	—	—	<b>35-356</b>
1-5/8	—	—	<b>35-357</b>
1-11/16	—	—	<b>35-358</b>
1-3/4	1-1/2	1-1/4	<b>35-359</b>
1-13/16	—	—	<b>35-360</b>
1-7/8	—	—	<b>35-361</b>
2	—	1-1/2	<b>35-362</b>
2-1/16	—	—	<b>35-363</b>
2-1/8	—	—	<b>35-364</b>
2-1/4	2	—	<b>35-365</b>
2-5/16	—	—	<b>35-366</b>
2-3/8	—	—	<b>35-367</b>
2-1/2	—	2	<b>35-368</b>
2-9/16	—	—	<b>35-369</b>
2-5/8	2-1/2	—	<b>35-370</b>
2-3/4	—	—	<b>35-371</b>
2-7/8	—	—	<b>35-372</b>
<b>Use Arbor No. 35-394, 35-536, 35-537 or 35-538</b>			
3	—	2-1/2	<b>35-373</b>
3-1/8	—	—	<b>35-374</b>
3-1/4	3	—	<b>35-375</b>
3-3/8	—	—	<b>35-376</b>
3-1/2	—	—	<b>35-377</b>
3-5/8	—	3	<b>35-378</b>
3-3/4	3-1/2	—	<b>35-379</b>
3-7/8	—	—	<b>35-380</b>
4	—	—	<b>35-381</b>
4-1/8	—	3-1/2	<b>35-382</b>
4-1/4	4	—	<b>35-383</b>
4-3/8	—	—	<b>35-384</b>
4-1/2	—	4	<b>35-385</b>
4-3/4	4-1/2	—	<b>35-386</b>
5	—	—	<b>35-387</b>
5-1/2	—	—	<b>35-388</b>
5-3/4	—	—	<b>35-389</b>
6	—	—	<b>35-390</b>

\*All pipe sizes listed in the Pipe Tap Size and Pipe Entrance Size columns are standard industry sizes. All pipes are sized by the nominal inside diameter.



# Tools and Totes

## Hole Saw Arbors

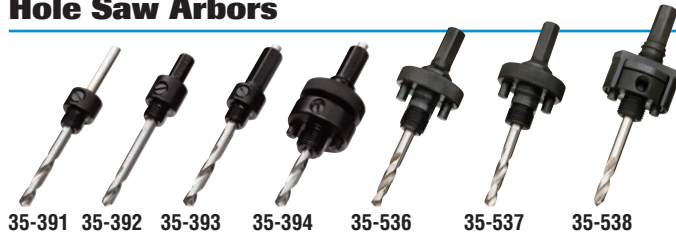

Durable steel construction means years of long-lasting performance. Set-screw in body allows easy replacement of the pilot drill. Save valuable time through this versatile design. Instantly change hole saws without tools and without having to remove the arbor from the chuck.

Shank Size	Thread Size	Chuck Size	Fits Hole Saw Sizes	Cat. No.
1/4 in. Round	1/2-20 in.	1/4 in.	9/16 - 1-3/16 in.	<b>35-391</b>
3/8 in. Hex	1/2-20 in.	3/8 in.	9/16 - 1-3/16 in.	<b>35-392</b>
7/16 in. Hex	1/2-20 in.	1/2 in.	9/16 - 1-3/16 in.	<b>35-393</b>
7/16 in. Hex	5/8-18 in.	1/2 in.	1-1/4 - 6 in.	<b>35-394</b>
7/16 in. Hex	5/8-18 in.	1/2 in.	1-1/4 - 6 in.	<b>35-536</b>
3/8 in. Hex	5/8-18 in.	3/8 in.	1-1/4 - 6 in.	<b>35-537</b>
7/16 in. Hex	5/8-18 in.	1/2 in.	2 - 6 in.	<b>35-538</b>

## Replacement Pilot Drills for Hole Saw Arbors

Split point pilot drills start on contact for faster penetration and less walking.



Description	Cat. No.
4-1/2 in. x 1/4 in. – Fits 35-391, 35-393, 35-394 & 35-538 arbors	<b>35-397</b>
3-1/4 in. x 1/4 in. – Fits 35-392, 35-536 & 35-537 arbors	<b>35-398</b>

## Arbor Extension

For boring jobs that require a longer reach, arbor extensions add up to 18 in. length and can be easily connected to IDEAL hole saw arbors.



Description	Cat. No.
Extension for 7/16 in. Arbors, 12 in. long	<b>35-396</b>

## Adjustable Can Light Hole Saws

- Cuts drywall and ceiling tile
- Self-sharpening carbide coated cutting blades
- Includes two dust shields to minimize clean up



*Drill not included.*

Description	Cat. No.
Adjustable Can Light Hole Saw – 10 sizes from 2-1/2 in. to 7 in.	<b>35-598</b>
Adjustable Can Light Hole Saw – 13 sizes from 6-1/4 in. to 10-3/8 in.	<b>35-599</b>

## Hole Saw Kits

### Electrician's Hole Saw Kit

- Reliable 8-piece kit in a durable plastic case
- Find electrical sizes for pipe and conduit through 2 in.



#### Kit 35-400 Includes:

Description	Cat. No.
Hole Saw sizes 7/8 in., 1-1/8 in., 1-3/8 in., 1-3/4 in., 2 in. & 2-1/2 in. Also includes arbor models 35-393 & 35-394	<b>35-400</b>

### 14-Piece Electrician's Hole Saw Kit

- Generous 14-piece kit offers a tremendous selection
- You'll find electrical sizes for pipe and conduit through 4 in.
- Sturdy plastic case survives extra wear and tear



#### Kit 35-401 Includes:

Description	Cat. No.
Hole Saw sizes 7/8 in., 1-1/8 in., 1-3/8 in., 1-3/4 in., 2 in., 2-1/2 in., 3 in., 3-5/8 in., 4-1/8 in., 4-1/2 in. Also includes arbor models 35-391, 35-393 & 35-394 and extension bar 35-396.	<b>35-401</b>

### 19-Piece Master Electrician's Hole Saw Kit

- For electrical, industrial and all-purpose maintenance needs
- 19-piece kit comes in sturdy durable plastic case
- Plumbing and electrical sizes for pipe and conduit through 4 in.



#### Kit 35-518 Includes:

Description	Cat. No.
Hole Saw sizes 3/4 in., 7/8 in., 1 in., 1-1/8 in., 1-3/8 in., 1-1/2 in., 1-3/4 in., 2 in., 2-1/4 in., 2-1/2 in., 3 in., 3-5/8 in., 4-1/8 in. & 4-1/2 in. Also includes arbor models 35-393, 35-394, pilot drill 35-397 (two pieces) and extension bar 35-396.	<b>35-518</b>

Hole Saws



## Reciprocating Blades

- Bi-metal blades last up to ten times longer than carbon steel blades
- Flexible spring-back provides long blade life
- Super-hard, high speed steel teeth for a sharp, long-lasting cutting edge
- Shatterproof for tough applications
- Fits all reciprocating saws using 1/2 in. universal shank



Reciprocating Blades

	L/W/TH (Inches)	TPI	Material	Blade Bock	Qty.	Application	Cat. No.
<b>Metal Cutting</b>							
	6 x 3/4 x .035	14	Bi-metal	Straight	5	Pipe, structural steel, stainless steel: 3/32" - 1/4", Non-ferrous metal: 3/32" - 3/8"	<b>36-059</b>
	6 x 3/4 x .035	14	Bi-metal	Straight	25	Pipe, structural steel, stainless steel: 3/32" - 1/4", Non-ferrous metal: 3/32" - 3/8"	<b>36-059B</b>
	4 x 3/4 x .035	18	Bi-metal	Straight	5	Structural steel, pipe, conduit, stainless steel: 1/16" - 3/16" thick, Non-ferrous metal: 1/16" - 5/16" thick	<b>36-055</b>
	6 x 3/4 x .035	18	Bi-metal	Straight	5	Structural steel, pipe, conduit, stainless steel: 1/16" - 3/16" thick, Non-ferrous metal: 1/16" - 5/16" thick	<b>36-057</b>
	6 x 3/4 x .035	18	Bi-metal	Straight	25	Structural steel, pipe conduit, stainless steel: 1/16" - 3/16" thick, Non-ferrous metal: 1/16" - 5/16" thick	<b>36-057B</b>
	8 x 3/4 x .035	18	Bi-metal	Straight	5	Structural steel, pipe, conduit, stainless steel: 1/16" - 3/16" thick, Non-ferrous metal: 1/16" - 5/16" thick	<b>36-060</b>
	6 x 3/4 x .035	24	Bi-metal	Straight	5	All metal less than 1/8" thick: Tubing conduit, trim	<b>36-058</b>
	6 x 3/4 x .035	24	Bi-metal	Straight	25	All metal less than 1/8" thick: Tubing conduit, trim	<b>36-058B</b>
<b>Heavy-Duty Metal Cutting</b>							
	6 x 3/4 x .050	18	Bi-metal	Straight	2	Heavy-duty blade for cutting structural steel, pipe, conduit, stainless steel: 1/16" to 3/16" thick	<b>36-085</b>
	8 x 3/4 x .050	10/14	Bi-metal	Straight	2	Heavy-duty blade for cutting structural steel, pipe, conduit, stainless steel: 1/8" to 1/2" thick	<b>36-086</b>
	12 x 3/4 x .050	10/14	Bi-metal	Taper	5	Heavy-duty blade for cutting structural steel, pipe, conduit, stainless steel: 1/8" to 1/2" thick	<b>36-087</b>
<b>Wood w/Nails</b>							
	6 x 3/4 x .050	6	Bi-metal	Taper	5	Fast cutting, roughing-in work, nail-embedded wood, remodeling	<b>36-065</b>
	6 x 3/4 x .050	6	Bi-metal	Taper	25	Fast cutting, roughing-in work, nail-embedded wood, remodeling	<b>36-065B</b>
	9 x 3/4 x .050	6	Bi-metal	Taper	5	Fast cutting, roughing-in work, nail-embedded wood, remodeling	<b>36-066</b>
	12 x 3/4 x .050	6	Bi-metal	Taper	5	Fast cutting, roughing-in work, nail-embedded wood, remodeling	<b>36-067</b>
<b>Demolition</b>							
	9 x 7/8 x .062	6	Bi-metal	Taper	2	Demolition work in nail-embedded wood, remodeling	<b>36-095</b>
	9 x 7/8 x .062	10	Bi-metal	Taper	2	Demolition work in wood, metal, pipe and fire and rescue	<b>36-096</b>
<b>General Purpose</b>							
	6 x 3/4 x .035	10	Bi-metal	Straight	5	Nail embedded wood, metal and non-ferrous metal composition materials & plastics 1/8" - 1/2"	<b>36-075</b>
<b>Specialty Cutting</b>							
	8 x 3/4 x .050	Grit	Tung. Grit	Straight	2	Iron pipe, fiberglass, reinforced plastics, ceramic tile, stone, slate and brick.	<b>36-090</b>
	3 x 5/16 x .035	18	Bi-Metal	Scroll	5	Scroll cutting wood, cast aluminum and non-ferrous metals	<b>36-054</b>
<b>Plaster/Drywall</b>							
	6 x 3/4 x .050	6	Bi-metal	Taper	2	For plaster, drywall, plaster board & lath. Bi-directional cutting	<b>36-088</b>

# Tools and Totes

## Long-Life Metal Cutting Reciprocating Blades

- Engineered to be the longest lasting, metal cutting blades available
- Long-life blades perform up to three times as many cuts as similar metal cutting blades
- 8% cobalt cutting edge for extreme durability
- Shatterproof bi-metal design
- Longer life for greater value



Long-Life Blades	L/W/TH (Inches)	TPI	Material	Blade Bock	Qty.	Application	Cat. No.
	6 x 3/4 x .035	18	Bi-metal	Straight	5	Long-Life blade for cutting structural steel, pipe, conduit, stainless steel, sheet metal: 1/16" - 3/16" thick	<b>36-043</b>
	8 x 3/4 x .035	18	Bi-metal	Straight	5	Long-Life blade for cutting structural steel, pipe, conduit, stainless steel, sheet metal: 1/16" - 3/16" thick	<b>36-044</b>
	6 x 1 x .042	14	Bi-metal	Straight	5	Long-life blade for cutting rebar, barstock, angle iron and other heavy gauge metals: 1/8" and thicker	<b>36-046</b>
	12 x 1 x .050	14	Bi-metal	Straight	5	Long-life blade for cutting rebar, barstock, angle iron and other heavy gauge metals: 1/8" and thicker	<b>36-048</b>

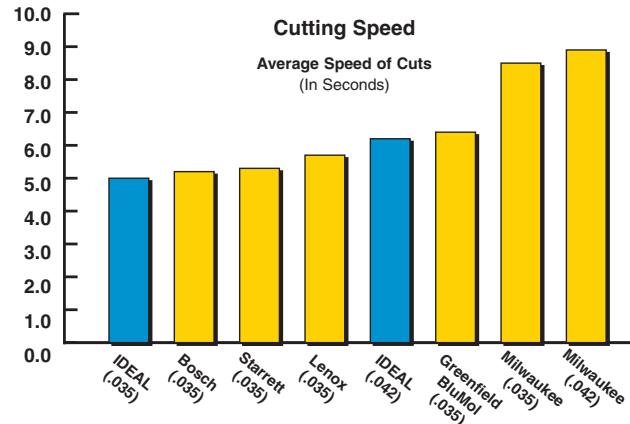
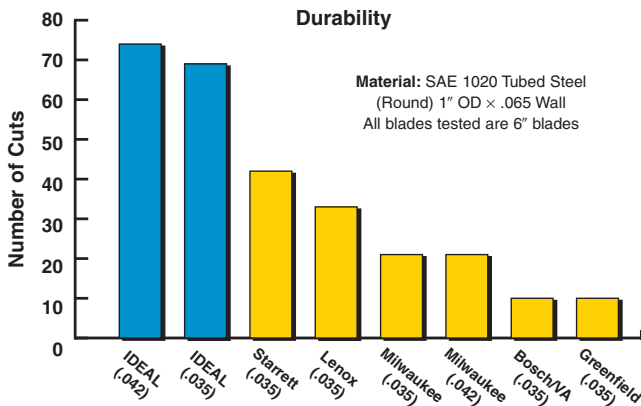

## Progressive Tooth Reciprocating Blades

- Specially designed for all purpose cutting
- Cut multiple materials without changing blades
- Tough bi-metal and HCS construction for long life.

Long-Life Blades	L/W/TH (Inches)	Material	Blade Bock	Qty.	Application	Cat. No.
	6 x 3/4 x .035	Progressive	Bi-metal	5	All metal, non-ferrous metal, sheet metal, pipe and other metal materials	<b>36-056</b>
	8 x 3/4 x .050	Progressive	Bi-metal	5	For wood, nail-embedded wood, non-ferrous metals, plastic and fiberglass	<b>36-076</b>

## Portable Band Saw Blades

- Bi-metal construction
- Fit all standard portable band saw machines
- For pipe, tubing and solids
- Cut any machinable metal, including conduit, angle iron, structurals, rebar and stainless steel tubing

L/W/TH (Inches)	TPI	Qty./Pack	Cat. No.
44-7/8 x 1/2 x .020	10	3	<b>36-070</b>
44-7/8 x 1/2 x .020	14	3	<b>36-071</b>
44-7/8 x 1/2 x .020	18	3	<b>36-072</b>
44-7/8 x 1/2 x .020	24	3	<b>36-073</b>







## BULZ-EYE Self Feed Wood Boring Bits

Introducing the new premium line of BULZ-EYE™ self-feed wood boring bits from IDEAL INDUSTRIES, INC. BULZ-EYE™ self-feed bits include a number of superior features and benefits that combine to deliver the most outstanding performance of any self-feed bit product available today. The new design features twin cutting edges and precision ground teeth with up to 50% wider cutting surface. These features deliver improved cutting speeds, better balance and control, and clean more accurate holes than the leading brand in the market. BULZ-EYE™ self-feed bits are manufactured with the best materials and machinery available to ensure quality, performance and consistency. The bits are also black oxide coated, heat treated and hardened for added durability. When it comes to quality, performance and durability, IDEAL is the professional's choice for self-feed bits.

Wood Boring Bits

Description	Diameter	Entrance Size for Pipe & EMT	Cat. No.
1 in. Self-Feed Wood Boring Bit	1 in.	1/2 in.	36-250
1-1/8 in. Self-Feed Wood Boring Bit	1-1/8 in.	—	36-251
1-1/4 in. Self-Feed Wood Boring Bit	1-1/4 in.	3/4 in.	36-252
1-3/8 in. Self-Feed Wood Boring Bit	1-3/8 in.	1 in.	36-253
1-1/2 in. Self-Feed Wood Boring Bit	1-1/2 in.	—	36-254
1-3/4 in. Self-Feed Wood Boring Bit	1-3/4 in.	1-1/4 in.	36-255
2 in. Self-Feed Wood Boring Bit	2 in.	1-1/2 in.	36-256
2-1/8 in. Self-Feed Wood Boring Bit	2-1/8 in.	—	36-257
2-1/4 in. Self-Feed Wood Boring Bit	2-1/4 in.	—	36-258
2-9/16 in. Self-Feed Wood Boring Bit	2-9/16 in.	2 in.	36-259
3 in. Self-Feed Wood Boring Bit	3 in.	2-1/2 in.	36-260
3-5/8 in. Self-Feed Wood Boring Bit	3-5/8 in.	3 in.	36-261
4-5/8 in. Self-Feed Wood Boring Bit	4-5/8 in.	4 in.	36-262
5-1/2 in. Extension	Ext	—	36-273
18 in. Extension	Ext	—	36-819

All bits are 4-5/8 in. long and come with a 7/16 in. shank designed to easily accommodate all 1/2 in. drill chucks.

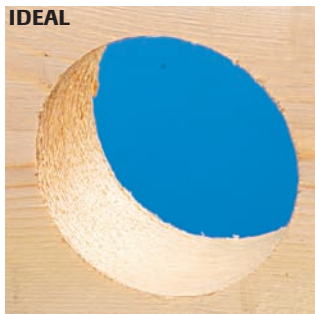

Cuts a smoother, more accurate hole with less splintering than competitive bits. This decreases resistance during pipe installation and improves on-the-job productivity.

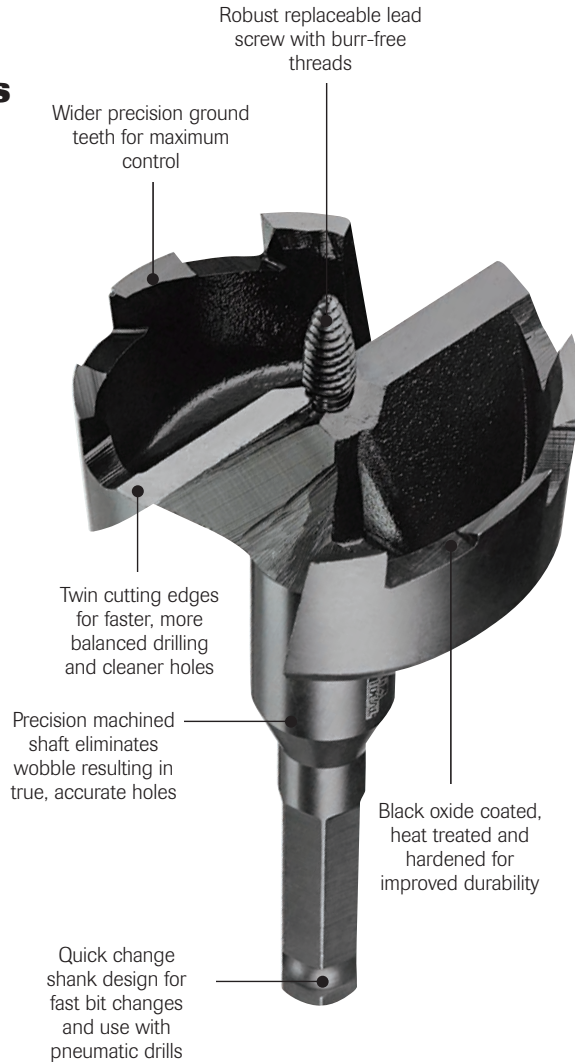

Quickly powers through wet and treated woods with no binding or jamming.



# Tools and Totes

## Replacement Lead Screws

- Keeps self-feed bits running fast and true
- Easily replaced with hex wrench providing extended drill life and optimum cost-per-hole value

36-271



36-270



Description	Cat. No.
3-pack small replacement lead screws, fits bit sizes 1 in. - 2-9/16 in.	<b>36-271</b>
3-pack large replacement lead screws, fits bit sizes 3 in. - 4-5/8 in.	<b>36-270</b>

## Extension Bars

- Cuts into hard-to-reach areas
- Fits IDEAL Auger Bits



Description	Cat. No.
5-1/2 in. Extension Bar	<b>36-273</b>
18 in. Extension Bar	<b>35-819</b>

## Sharpening File

- Keeps durable bits working like new
- High-grade sharpener hones dulled edges quickly and efficiently



Description	Cat. No.
Sharpening File	<b>36-272</b>

## 5-Piece Kit

Includes four different bit sizes, a 5-1/2 in. extension bar, and a convenient carrying case, giving you everything you need for drilling multiple hole sizes in any wood material.



### Kit 36-265 Includes:

Description	Cat. No.
5-1/2 in. extension bar, 1-3/8 in., 1-1/2 in., 2-1/8 in., 2-9/16 in. bits	<b>36-265</b>

## 6-Piece Kit

Includes five different bit sizes, a 5-1/2 in. extension bar, and a convenient carrying case, giving you everything you need for drilling multiple hole sizes in any wood material.

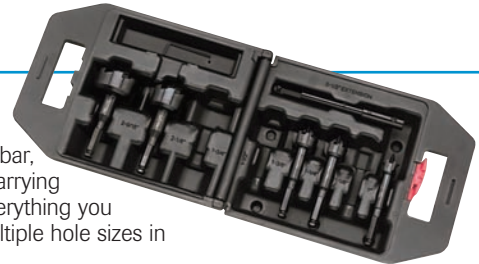

### Kit 36-266 Includes:

Description	Cat. No.
5-1/2 in. extension bar, 1 in., 1-1/4 in., 1-3/8 in., 2 in., 2-9/16 in. bits	<b>36-266</b>

## 9-Piece Kit

Includes eight different bit sizes, a 5-1/2 in. extension bar, and a convenient carrying case, giving you everything you need for drilling multiple hole sizes in any wood material.



### Kit 36-269 Includes:

Description	Cat. No.
5-1/2 in. extension bar, 1 in., 1-1/8 in., 1-1/4 in., 1-3/8 in., 1-1/2 in., 1-3/4 in., 2-1/8 in., 2-9/16 in. bits	<b>36-269</b>

*Lead screws can be easily replaced with the use of a hex wrench providing extended drilling life and optimum cost-per-hole value.*





### Nailbiter™ Premium Ship Auger Bits

- Dual-Helix construction with twin cutting edges provides faster and smoother drilling action, even through nail-embedded timbers
- Full body, dual induction heat treatment ensures durability, minimizes warping and delivers long lasting performance
- Heavy-duty lead screw designed for quick gripping power, superior penetration and extra-long life
- Re-sharpenable for extended tool life

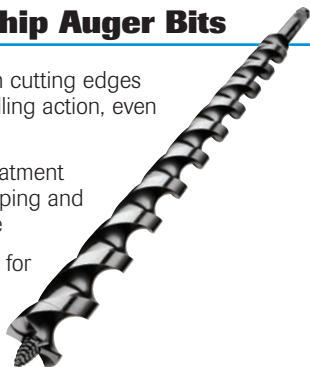

Power Ship Augers - Bit Length = 7-1/2", Twist = 5", Shank = 7/16"				
Description	Hole Diameter	Overall Length	Twist Length	Cat. No.
5/8 in. Power Ship Auger	5/8 in.	7-1/2 in.	5 in.	<b>35-810</b>
11/16 in. Power Ship Auger	11/16 in.	7-1/2 in.	5 in.	<b>35-811</b>
3/4 in. Power Ship Auger	3/4 in.	7-1/2 in.	5 in.	<b>35-812</b>
13/16 in. Power Ship Auger	13/16 in.	7-1/2 in.	5 in.	<b>35-813</b>
7/8 in. Power Ship Auger	7/8 in.	7-1/2 in.	5 in.	<b>35-814</b>
1 in. Power Ship Auger	1 in.	7-1/2 in.	5 in.	<b>35-815</b>
1-1/8 in. Power Ship Auger	1-1/8 in.	7-1/2 in.	5 in.	<b>35-816</b>
1-1/4 in. Power Ship Auger	1-1/4 in.	7-1/2 in.	5 in.	<b>35-817</b>
Power Ship Augers - Bit Length = 18", Twist = 15", Shank = 7/16"				
Description	Hole Diameter	Overall Length	Twist Length	Cat. No.
1/2 in. Power Ship Auger	1/2 in.	18 in.	15 in.	<b>35-820</b>
5/8 in. Power Ship Auger	5/8 in.	18 in.	15 in.	<b>35-821</b>
11/16 in. Power Ship Auger	11/16 in.	18 in.	15 in.	<b>35-822</b>
3/4 in. Power Ship Auger	3/4 in.	18 in.	15 in.	<b>35-823</b>
13/16 in. Power Ship Auger	13/16 in.	18 in.	15 in.	<b>35-824</b>
7/8 in. Power Ship Auger	7/8 in.	18 in.	15 in.	<b>35-825</b>
15/16 in. Power Ship Auger	15/16 in.	18 in.	15 in.	<b>35-826</b>
1 in. Power Ship Auger	1 in.	18 in.	15 in.	<b>35-827</b>
1-1/8 in. Power Ship Auger	1-1/8 in.	18 in.	15 in.	<b>35-828</b>
1-1/4 in. Power Ship Auger	1-1/4 in.	18 in.	15 in.	<b>35-829</b>

### Mini™ Utility Bit Augers

- Designed to fit between wall studs when used with common drills
- Eliminates the need for expensive right angle drills



Mini™ Augers - Bit Length = 4-3/4", Twist = 2-1/2", Shank = 7/16"				
Description	Hole Diameter	Overall Length	Twist Length	Cat. No.
5/8 Mini™ Auger	5/8 in.	4-3/4 in.	2-1/2 in.	<b>35-862</b>
3/4 Mini™ Auger	3/4 in.	4-3/4 in.	2-1/2 in.	<b>35-864</b>
7/8 Mini™ Auger	7/8 in.	4-3/4 in.	2-1/2 in.	<b>35-866</b>
1 Mini™ Auger	1 in.	4-3/4 in.	2-1/2 in.	<b>35-868</b>

### RESI-MASTER™ Heavy-Duty Ship Augers

- 62° cutting angle reinforces the cutting edge and provides greater durability
- Hardened lead screw and cutting edge provide increased wear resistance and extended life
- Secondary relief angle evacuates wood chips quickly and prevents auger from jamming
- Oversized cutting head makes hole larger than body of bit for easy ejection from work piece

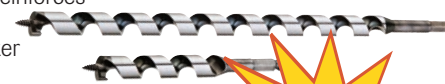

Power Ship Augers - Bit Length = 7-1/2", Twist = 5", Shank = 7/16"				
Description	Hole Diameter	Overall Length	Twist Length	Cat. No.
5/8 in. RESI-MASTER™ Auger	5/8 in.	7-1/2 in.	5 in.	<b>35-892</b>
11/16 in. RESI-MASTER™ Auger	11/16 in.	7-1/2 in.	5 in.	<b>35-730</b>
3/4 in. RESI-MASTER™ Auger	3/4 in.	7-1/2 in.	5 in.	<b>35-893</b>
13/16 in. RESI-MASTER™ Auger	13/16 in.	7-1/2 in.	5 in.	<b>35-892</b>
7/8 in. RESI-MASTER™ Auger	7/8 in.	7-1/2 in.	5 in.	<b>35-896</b>
15/16 in. RESI-MASTER™ Auger	15/16 in.	7-1/2 in.	5 in.	<b>35-897</b>
1 in. RESI-MASTER™ Auger	1 in.	7-1/2 in.	5 in.	<b>35-898</b>
1-1/8 in. RESI-MASTER™ Auger	1-1/8 in.	7-1/2 in.	5 in.	<b>35-899</b>
1-1/4 in. RESI-MASTER™ Auger	1-1/4 in.	7-1/2 in.	5 in.	<b>35-732</b>
Power Ship Augers - Bit Length = 18", Twist = 15", Shank = 7/16"				
Description	Hole Diameter	Overall Length	Twist Length	Cat. No.
1/2 in. RESI-MASTER™ Auger	1/2 in.	18 in.	15 in.	<b>35-726</b>
5/8 in. RESI-MASTER™ Auger	5/8 in.	18 in.	15 in.	<b>35-971</b>
11/16 in. RESI-MASTER™ Auger	11/16 in.	18 in.	15 in.	<b>35-727</b>
3/4 in. RESI-MASTER™ Auger	3/4 in.	18 in.	15 in.	<b>35-972</b>
13/16 in. RESI-MASTER™ Auger	13/16 in.	18 in.	15 in.	<b>35-728</b>
7/8 in. RESI-MASTER™ Auger	7/8 in.	18 in.	15 in.	<b>35-976</b>
15/16 in. RESI-MASTER™ Auger	15/16 in.	18 in.	15 in.	<b>35-977</b>
1 in. RESI-MASTER™ Auger	1 in.	18 in.	15 in.	<b>35-978</b>
1-1/8 in. RESI-MASTER™ Auger	1-1/8 in.	18 in.	15 in.	<b>35-979</b>
1-1/4 in. RESI-MASTER™ Auger	1-1/4 in.	18 in.	15 in.	<b>35-729</b>

### Auger Bit Extensions

\*Dual locking screws



Auger Bit Extensions, 18 in. Six flats to fit drill chuck – Allen wrench included	
Description	Cat. No.
Auger Bit Extension – 5/16 in.	<b>35-818</b>
Auger Bit Extension – 7/16 in.	<b>35-819</b>

Flexible Drill Bits

# Tools and Totes

## Flexible Drill Bits



Professional drill bits drill and fish wire in one easy step. Drill and pull wire through blind areas in ceilings, walls and floors. Shanks are made from premium heat-treated spring steel for maximum flexibility while practically eliminating any retained shank bend. A three-flat non-slip grip on the shank and fish holes in both the tip and shank insure trouble-free wire pulling in either direction. Our tip design provides superior tip/shank contact, increasing the strength and durability of the braze and preventing separation when striking nails or other obstructions. Multiple styles are available for a variety of applications.

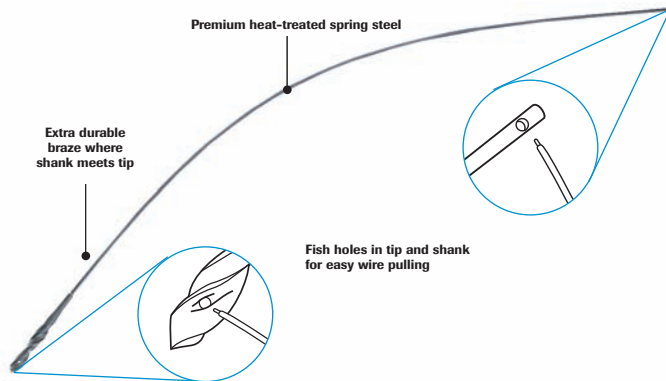

## Screw Point Flexible Bits, Type B

- Fast and aggressive, self-starting bit
- Ultra-sharp ground threads provide increased pulling power through obstructions
- Designed for easy to tough wood drilling



Description	Shank	Cat. No.
3/8 in. x 24 in. Screw Point Flexible Bit	3/16	90-080
3/8 in. x 36 in. Screw Point Flexible Bit	3/16	90-081
3/8 in. x 54 in. Screw Point Flexible Bit	3/16	90-082
3/8 in. x 72 in. Screw Point Flexible Bit	3/16	90-083
1/2 in. x 36 in. Screw Point Flexible Bit	3/16	90-084
1/2 in. x 54 in. Screw Point Flexible Bit	3/16	90-085
1/2 in. x 72 in. Screw Point Flexible Bit	3/16	90-086
9/16 in. x 36 in. Screw Point Flexible Bit	3/16	90-087
9/16 in. x 54 in. Screw Point Flexible Bit	3/16	90-088
9/16 in. x 72 in. Screw Point Flexible Bit	3/16	90-089
3/4 in. x 36 in. Screw Point Flexible Bit	1/4	90-090
3/4 in. x 54 in. Screw Point Flexible Bit	1/4	90-091
3/4 in. x 72 in. Screw Point Flexible Bit	1/4	90-092

## Flexible Bit Extensions

- Three lengths available for 3/16 in. and 1/4 in. shaft diameters
- Connect to chuck end of shaft to increase the length of the bit



Description	Shank	Cat. No.
3/16 in. x 36 in. Flexible Bit Extension	3/16	90-170
3/16 in. x 54 in. Flexible Bit Extension	3/16	90-171
1/4 in. x 36 in. Flexible Bit Extension	1/4	90-173
1/4 in. x 54 in. Flexible Bit Extension	1/4	90-174

## Flexible Bit Placement Tool

- Use as a positioning guide for the flexible drill bits
- Aids in more accurate placement of bit tips within walls
- Increases directional control during drilling



Description	Cat. No.
Flexible Bit Placement Tool	90-176

## Serrated Combination Flexible Bits, Type C

- Multi-purpose versatile bit for clean holes
- Designed for easy to medium wood drilling and light metal
- Pressure is needed for starting and pulling the bit through the wood



Description	Shank	Cat. No.
1/4 in. x 54 in. Serrated Combination Flexible Bit	3/16	90-063
3/8 in. x 54 in. Serrated Combination Flexible Bit	3/16	90-067
1/2 in. x 54 in. Serrated Combination Flexible Bit	3/16	90-070
9/16 in. x 54 in. Serrated Combination Flexible Bit	3/16	90-073

## Masonry Flexible Bits, Type M

- Masonry drill bit
- Designed for drilling in lightweight masonry materials



Description	Shank	Cat. No.
3/8 in. x 54 in. Masonry Flexible Bit	3/16	90-124
1/2 in. x 72 in. Masonry Flexible Bit	1/4	90-128

## Installer Bits

- Hole in fluted head for pulling wires through walls, ceiling and floors
- Flutes designed for quick chip removal – no clogging or binding
- Premium quality, extra-hard 52-100 carbon bearing steel

Description	Length	Cat. No.
Installer Bit – 1/4 in.	18 in.	35-870
Installer Bit – 3/8 in.	18 in.	35-871
Installer Bit – 1/2 in.	18 in.	35-872

Flexible Drill Bits





Hand Tools/Saws

### Jab Saw



- Includes replaceable bi-metal wallboard blade
- Holds all reciprocating blades and hack-saw blades
- Ergonomic grip

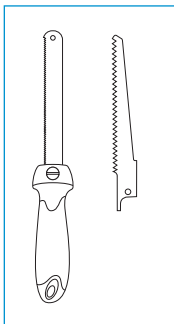
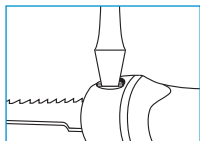

Description	Cat. No.
Jab Saw	35-275
Replacement blade	36-088

### Folding Saw



- Light-weight, heavy-duty die cast construction
- Ergonomic rubber comfort grip
- Blade safely and conveniently folds down in handle
- Accepts all standard 6 in. recip blades

Description	Cat. No.
Folding Saw	35-274

### Aviation Tin Snips

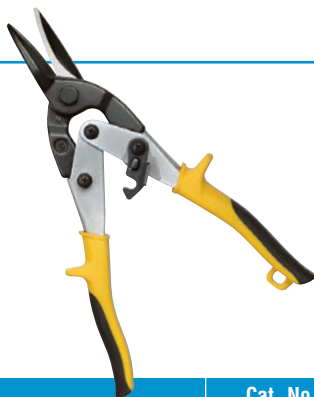

- Chrome-molybdenum steel forged blades for greater strength and durability
- Serrated edges provide a stable hold when cutting
- Labor-saving design for easier cutting
- Comfortable non-slip dual durometer grips

Description	Cat. No.
Straight Cut Aviation Tin Snips	35-001

### Heavy-Duty Hacksaw

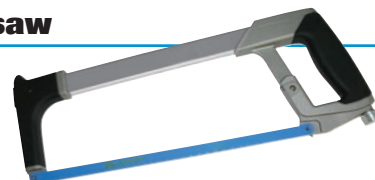

- Cushioned ergonomic grip for performance and comfort
- Rugged frame provides lightweight rigidity and exceptional control
- Stores up to nine extra blades
- Blades can be adjusted to 55° angle for flush cutting and tensioned to 30,000 psi
- Includes 12 in. x 24T bi-metal blade



Description	Cat. No.
Heavy-Duty Hacksaw	35-260

### Ergonomic Hacksaw



- Angled handle for easier cutting
- Blade can easily be adjusted for flush cutting
- Easy tensioning wing-nut keeps blades tight for straighter cuts
- Cushioned ergonomic grip for performance and comfort
- Includes 12 in. x 24T bi-metal blade

Description	Cat. No.
Ergonomic Hacksaw	35-261

### Mini Hacksaw



- Heavy-duty die cast frame
- Non-slip rubber comfort grip
- Accepts all standard hacksaw blades

Description	Cat. No.
Mini Hacksaw	35-259

### Hacksaw Blades

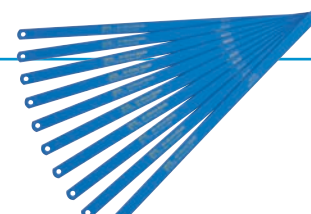

- Bi-metal blades provide strength, flexibility and longer life

Description	Qty./Pack	Cat. No.
12 in. x 18T Blades	10	35-271
12 in. x 24T Blades	10	35-272
12 in. x 32T Blades	10	35-273
12 in. x 18T Blades	100	35-262
12 in. x 24T Blades	100	35-263
12 in. x 32T Blades	100	35-264



## **X-ON Electronics**

Largest Supplier of Electrical and Electronic Components

*Click to view similar products for [gc electronics manufacturer](#):*

Other Similar products are found below :

[65-1964-15](#) [65-5020](#) [D1796](#) [ML-1156](#) [ML-7234AS15](#) [ML-PR-6](#) [9073](#) [9086](#) [12-008](#) [12-026](#) [12-073](#) [12-076](#) [12-077](#) [HD-4211](#) [12-166](#) [12-312](#) [12-634](#) [12-531](#) [12-552](#) [12-6994](#) [12-9001](#) [12-9105](#) [14-1550-8L84](#) [14-1918](#) [14-1918-1H81](#) [14-216-2F53](#) [14-1350-8L87](#) [14-218-2E83](#) [DO-16](#) [14-420-1D19](#) [14-420-1D41](#) [14-424-1B47](#) [14-424-1L18](#) [14-426-1H48](#) [14-426-1H82](#) [14-418-1E48](#) [14-420-1O83](#) [14-422-1C17](#) [14-424-1L44](#) [14-426-1K86](#) [19-820](#) [21-134](#) [P-2K-C](#) [22-272](#) [9296](#) [9300](#) [9358](#) [9486](#) [9493](#) [30-1213](#)