

49 PCB Mount Enclosed Relay/SPDT 3 - 10 Amp Rated

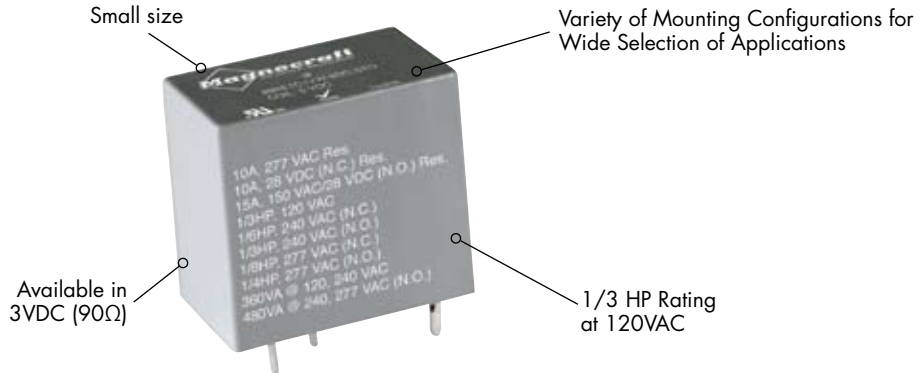

General Specifications

(UL 508)

10 Amp STO

Contact Characteristics		Units	SPDT	
Number and type of Contacts			Normally Open	Normally Closed
Contact materials			Silver Alloy	
Current rating		A	15	10
Switching voltage		~	277 V 50/60 Hz	
		≡	28 V	
		HP	1/3 @ 240 VAC	1/6 @ 240 VAC
		HP	1/4 @ 277 VAC	1/8 @ 277 VAC
Minimum Switching Requirement		Pilot Duty mA	B300 (120/240 VAC) 100	
Coil Characteristics				
Voltage Range		≡	V 3...24	
Operating Range	% of Nominal	≡	75% to 110%	
Average consumption		≡	W 0.11	
Drop-out voltage threshold		≡	10%	
Performance Characteristics				
Electrical Life	Operations @ Rated Current (Resistive)		100,000	
Mechanical Life	Unpowered		10,000,000	
Operating time (response time)		ms	25	
Dielectric	Between coil and contact	~	V 1500	
	Between contacts	~	V 500	
Environment				
Product certifications	Standard version		UL	
Ambient air temperature around the device	Storage	°C	-40...+85	
	Operation	°C	-40...+55	
Vibration resistance	Operational	g-n	3, 10 to 55 Hz	
Shock resistance		g-n	10	
Weight		grams	42	



5 Amp STO SPDT		3 Amp SIL SPDT	
Normally Open	Normally Closed	Normally Open	Normally Closed
Silver Alloy		Fine Silver	
5		15	3
120 V 50/60 Hz		150 V 50/60 Hz	
28 V		28 V	
1/3 @ 240 VAC	1/6 @ 240 VAC	1/3 @ 240 VAC	1/6 @ 240 VAC
1/4 @ 277 VAC	1/8 @ 277 VAC	1/4 @ 277 VAC	1/8 @ 277 VAC
B300 (120/240 VAC)		B300 (120/240 VAC)	
100		100	
3...24		3...24	5...24
75% to 110%		75% to 110%	
0.11		0.11	
10%		10%	
100,000		100,000	
10,000,000		10,000,000	
25		25	
2500		2500	
500		500	
UL		UL	
-40...+85		-40...+85	
-40...+55		-40...+55	
3, 10 to 55 Hz		3, 10 to 55 Hz	
10		10	
42		42	

49 PCB Mount Enclosed Relay/SPDT 3 - 10 Amp Rated *continued*

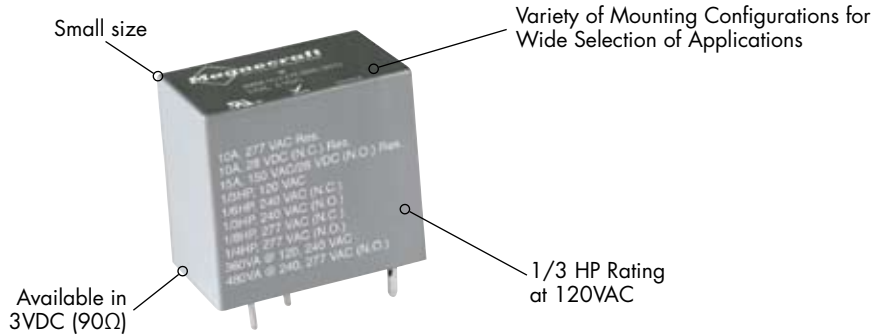

Standard Part Numbers

BOLD-FACED PART NUMBERS ARE NORMALLY STOCKED

Nominal Input Voltage 3 Amp, Style RE1C1	Nominal Coil Resistance (Ω)	Part Number	Contact Configuration
3 VDC	90 Ω	W49RE1C1VG-3DC-SIL	SPDT
5 VDC	235 Ω	W49RE1C1VG-5DC-SIL	SPDT
12 VDC	1350 Ω	W49RE1C1VG-12DC-SIL	SPDT
6 VDC	410 Ω	W49RE1C2VF-6DC-SIL	SPDT
12 VDC	1640 Ω	W49RE1C2VF-12DC-SIL	SPDT
24 VDC	6560 Ω	W49RE1C2VF-24DC-SIL	SPDT
5 Amp, Style RE1C1 and RE1C2			
5 VDC	235 Ω	W49RE1C1VG-5DC-STO	SPDT
12 VDC	1350 Ω	W49RE1C1VG-12DC-STO	SPDT
24 VDC	5400 Ω	W49RE1C1VG-24DC-STO	SPDT
6 VDC	410 Ω	W49RE1C2VF-6DC-STO	SPDT
12 VDC	1640 Ω	W49RE1C2VF-12DC-STO	SPDT
24 VDC	6560 Ω	W49RE1C2VF-24DC-STO	SPDT
10 Amp, Style RE1C1			
5 VDC	100 Ω	W49RE1C1VW-5DC-STO	SPDT
12 VDC	600 Ω	W49RE1C1VW-12DC-STO	SPDT
24 VDC	2400 Ω	W49RE1C1VW-24DC-STO	SPDT
10 Amp, Style R1C4			
5 VDC	235 Ω	W49R1C4VG-5DC-STO	SPDT
12 VDC	1350 Ω	W49R1C4VG-12DC-STO	SPDT
10 Amp, Style R1C4			
5 VDC	100 Ω	W49R1C4VW-5DC-STO	SPDT
24 VDC	2400 Ω	W49R1C4VW-24DC-STO	SPDT

Part Number Builder

Series	Footprint	Rating	Coil Voltage	Contact Material
49	RE1C1 = Narrow Footprint RE1C2 = Wide Footprint R1C4 = Top Mounting Bracket	VG = (RE1C1) 5A STO or 3A SIL VG (R1C4) = 10A STO VF = (RE1C2) 5A STO or 3A SIL VW = 10A STO	-5DC 3DC = 3 VDC 5DC = 5 VDC 6DC = 6 VDC 12DC = 12 VDC 24DC = 24 VDC	-SCO SIL = Fine Silver Contacts STO = Silver Alloy Contacts

CIRCUIT BOARD PIN SPACING VIEWED FROM COMPONENT SIDE (TOP VIEW)

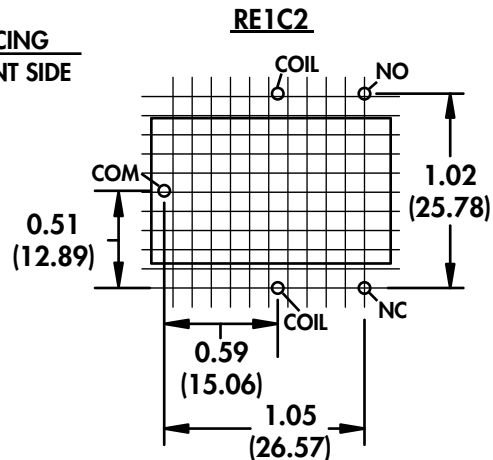
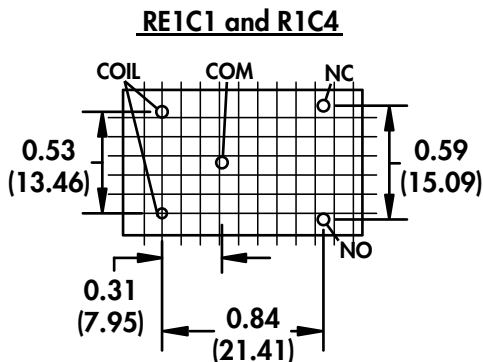

0.1 IN GRID
(2.54 MM)

PIN SPACINGS SHOWN AT 100% OF ACTUAL SIZE

STYLE RE1C1

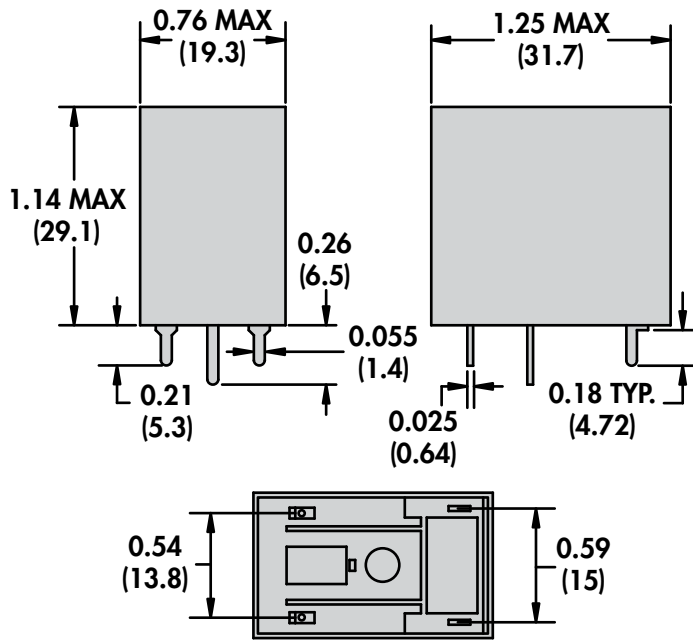

STYLE RE1C2

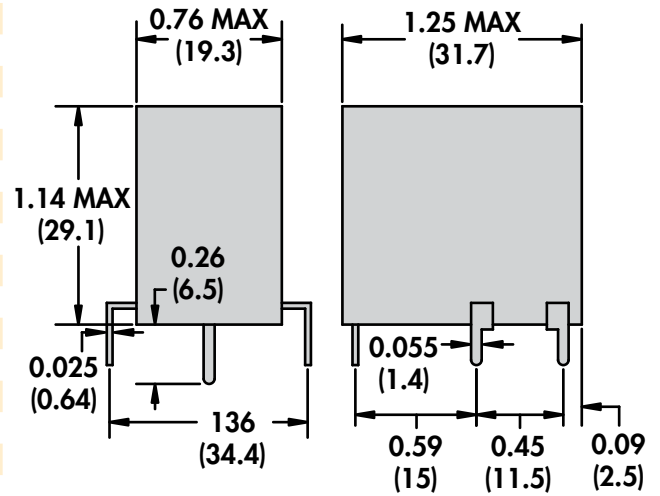

STYLE R1C4

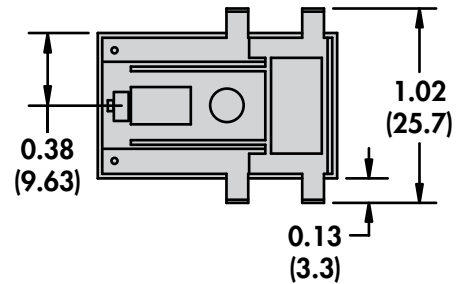
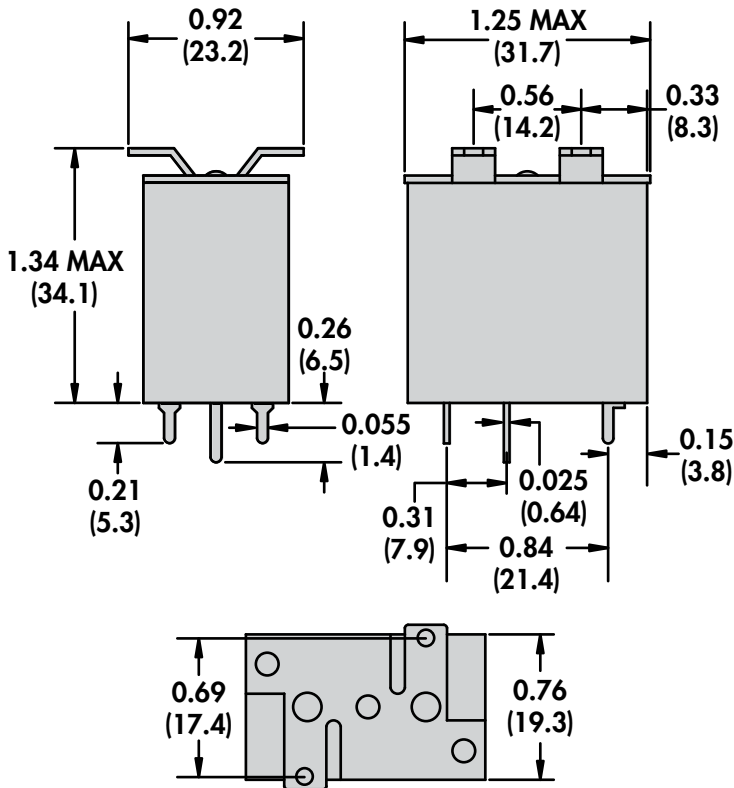

**WIRING DIAGRAMS
TOP VIEW**

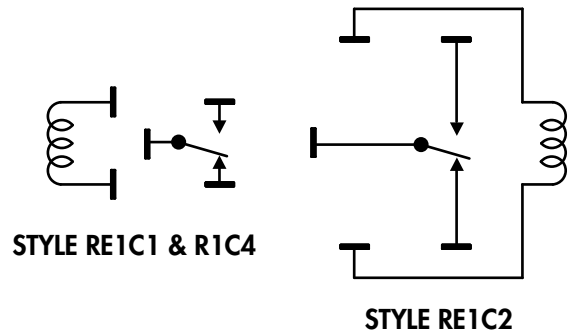

DRAWINGS SHOWN AT 100% OF ACTUAL SIZE

X-ON Electronics

Largest Supplier of Electrical and Electronic Components

Click to view similar products for [Low Signal Relays - PCB category](#):

Click to view products by [Magnecraft manufacturer](#):

Other Similar products are found below :

[6-1393813-4](#) [6-1462039-0](#) [6-1617529-6](#) [617-12](#) [M39016/11-048P](#) [67RPCX-3](#) [7-1393809-0](#) [7-1393813-3](#) [7556072001](#) [80.010.4522.1](#) [FTR-B4GA006Z](#) [FW1210S02](#) [9-1393813-6](#) [9-1617519-3](#) [9-1617582-5](#) [G6AK-2-H-DC5](#) [A-1.5W-K](#) [DF2E-L2-DC3V](#) [DS1EM24J](#) [DS1EM5J](#) [DS1ES5J](#) [DS4E-M-DC5V-H48](#) [EC2-4.5TNJ](#) [EC2-9NJ](#) [B07B939BC1-0868](#) [1608043-4](#) [1617076-5](#) [1617117-3](#) [1617137-2](#) [1617518-5](#) [1617560](#) [HMB1130K00](#) [HMB1131S06](#) [HMS1119S01](#) [HMS1131S10](#) [HMS1201S03](#) [HMS1201S87](#) [HMS1205S02](#) [2-1393807-6](#) [2-1617071-2](#) [2-1617594-1](#) [JMGSC-5LW](#) [K6-PS](#) [KHS-17D11-110](#) [9-1393761-0](#) [9-1617352-3](#) [9-1617583-1](#) [276XAXH-9D](#) [1617072-3](#) [1617075-4](#)