

Model produktu	<b>Z-76</b>	
Format:	A4	
Materiał:	Polystyrene (PS)	
Skala:	1:1	
Tolerancja:	+/- 0.1	
		
	ul. Nadmiejska 32 04-205 Warszawa Tel: +48 022 613-08-88, Fax: 812-10-68 www.kradex.com.pl	

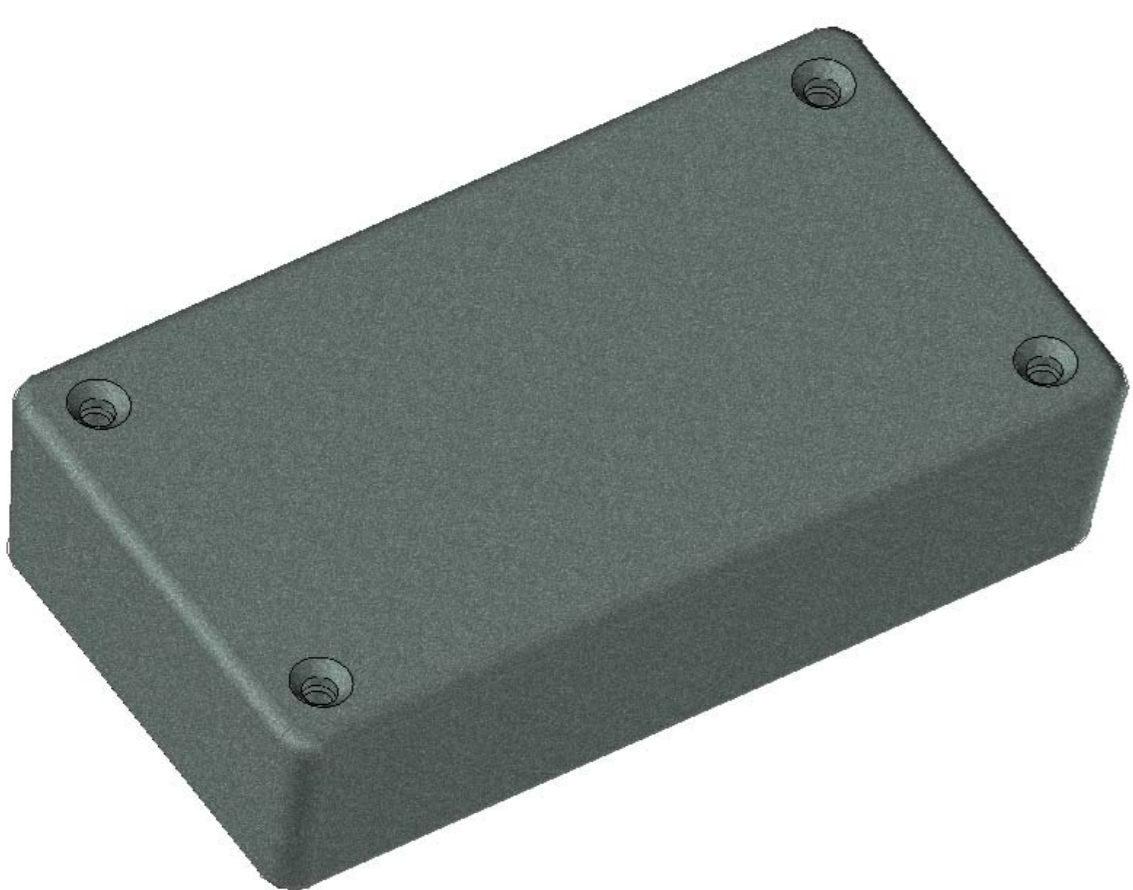

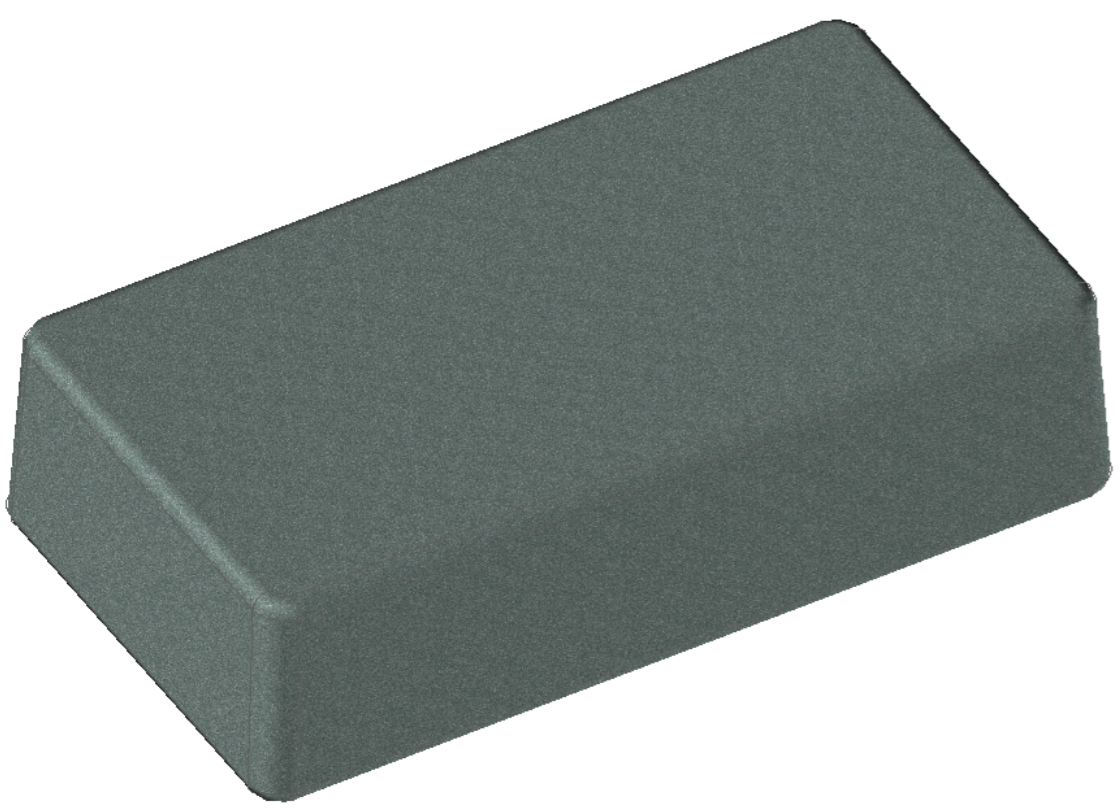

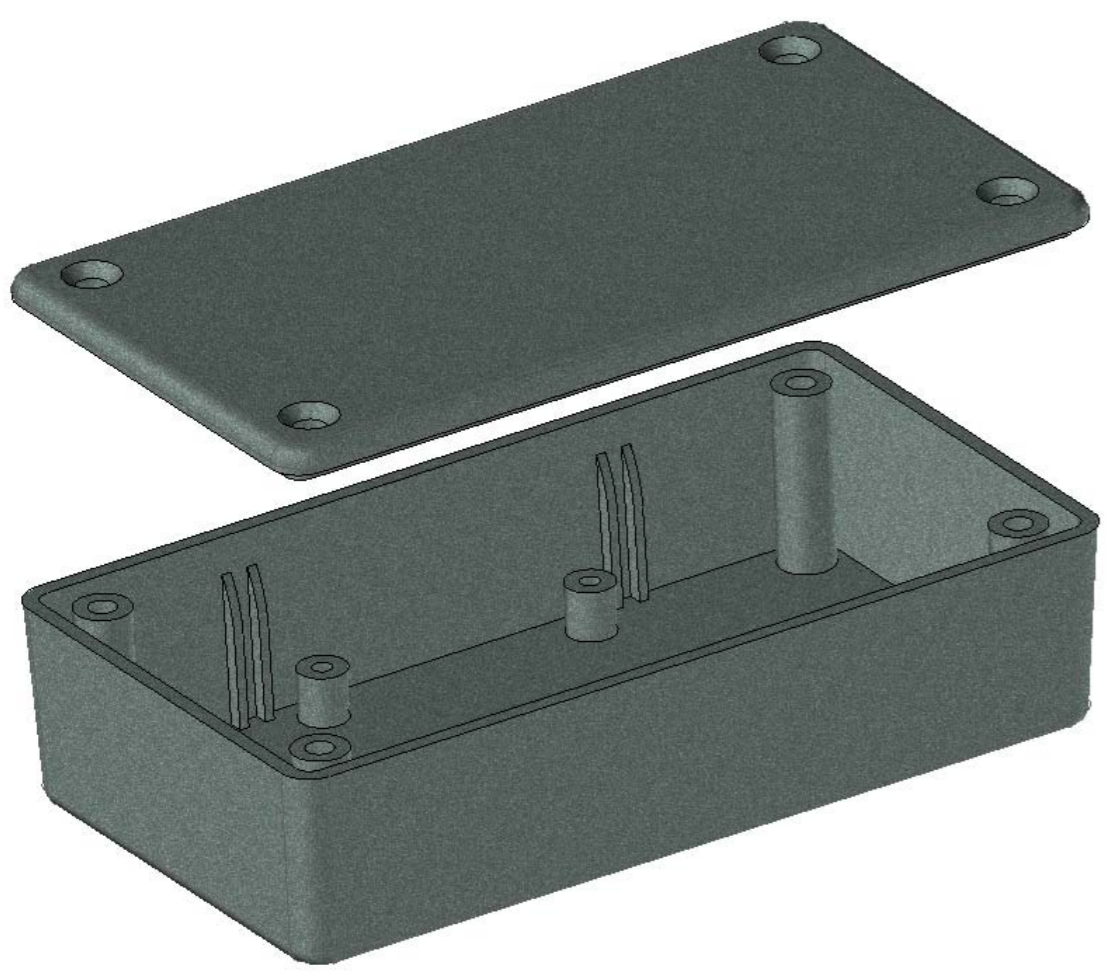

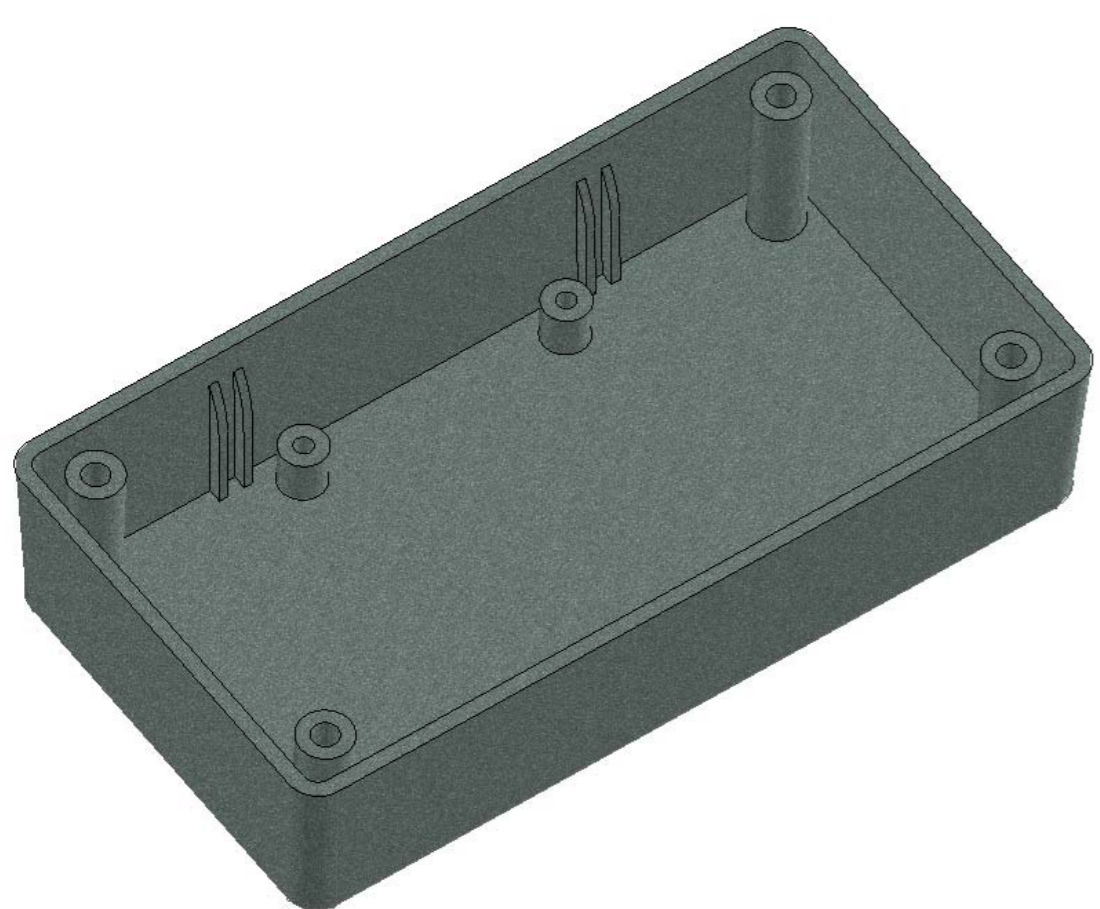

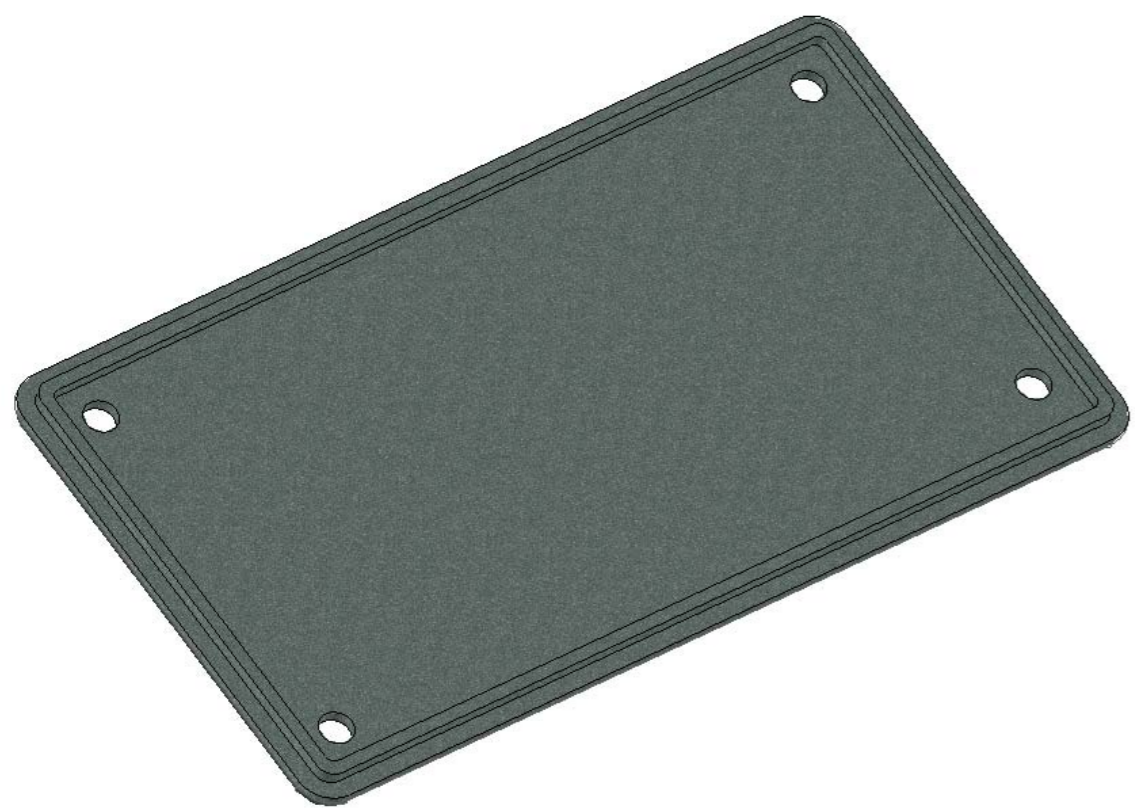

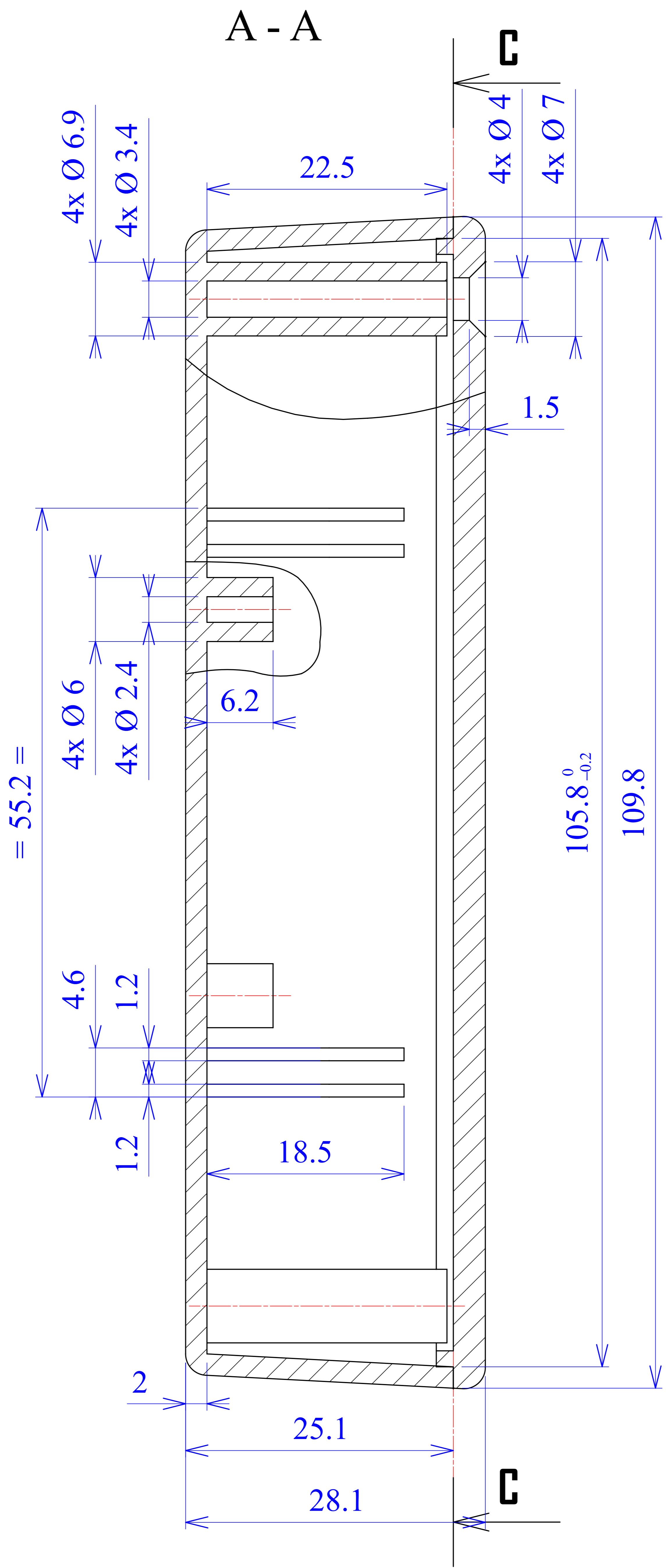

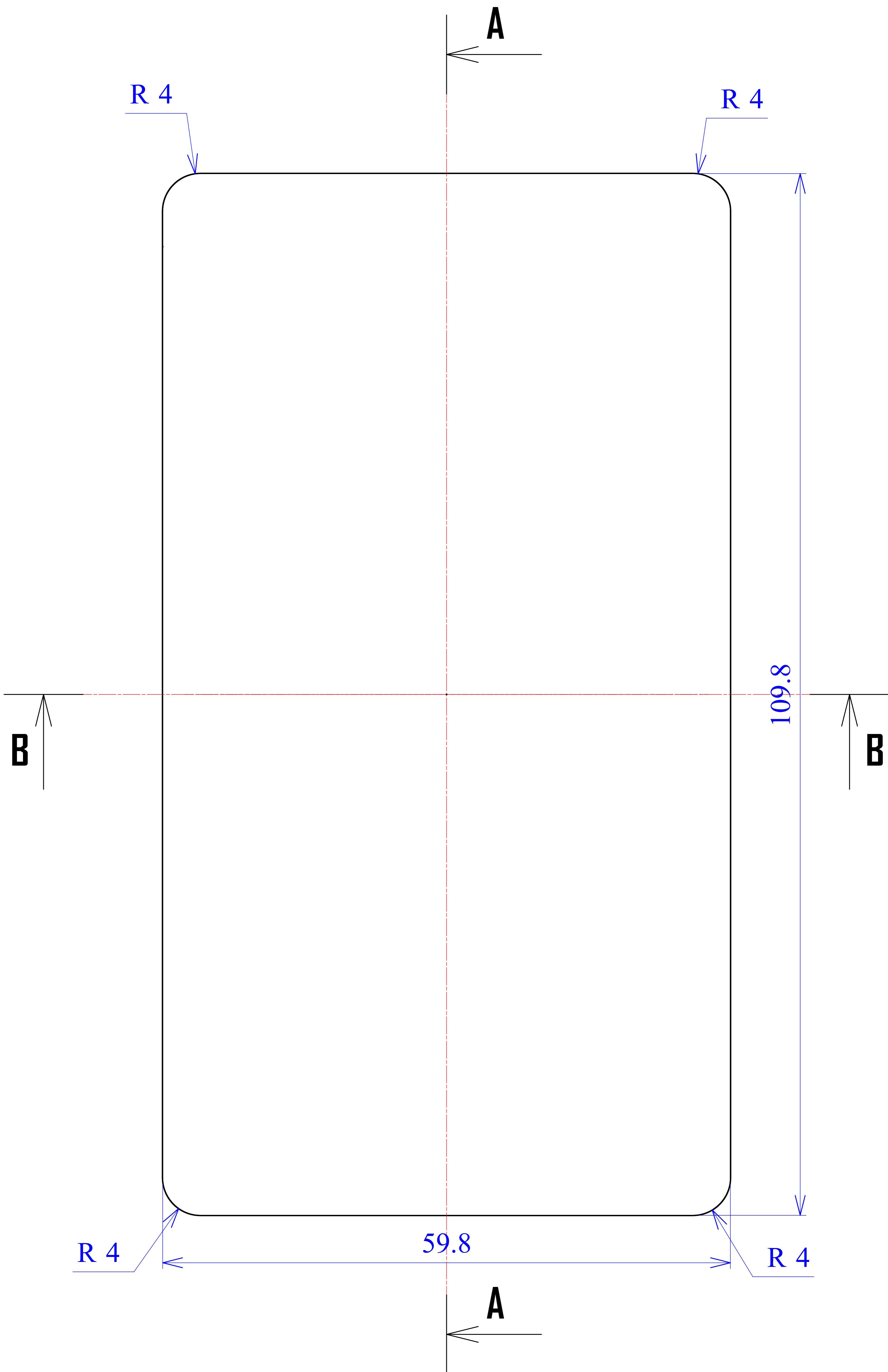



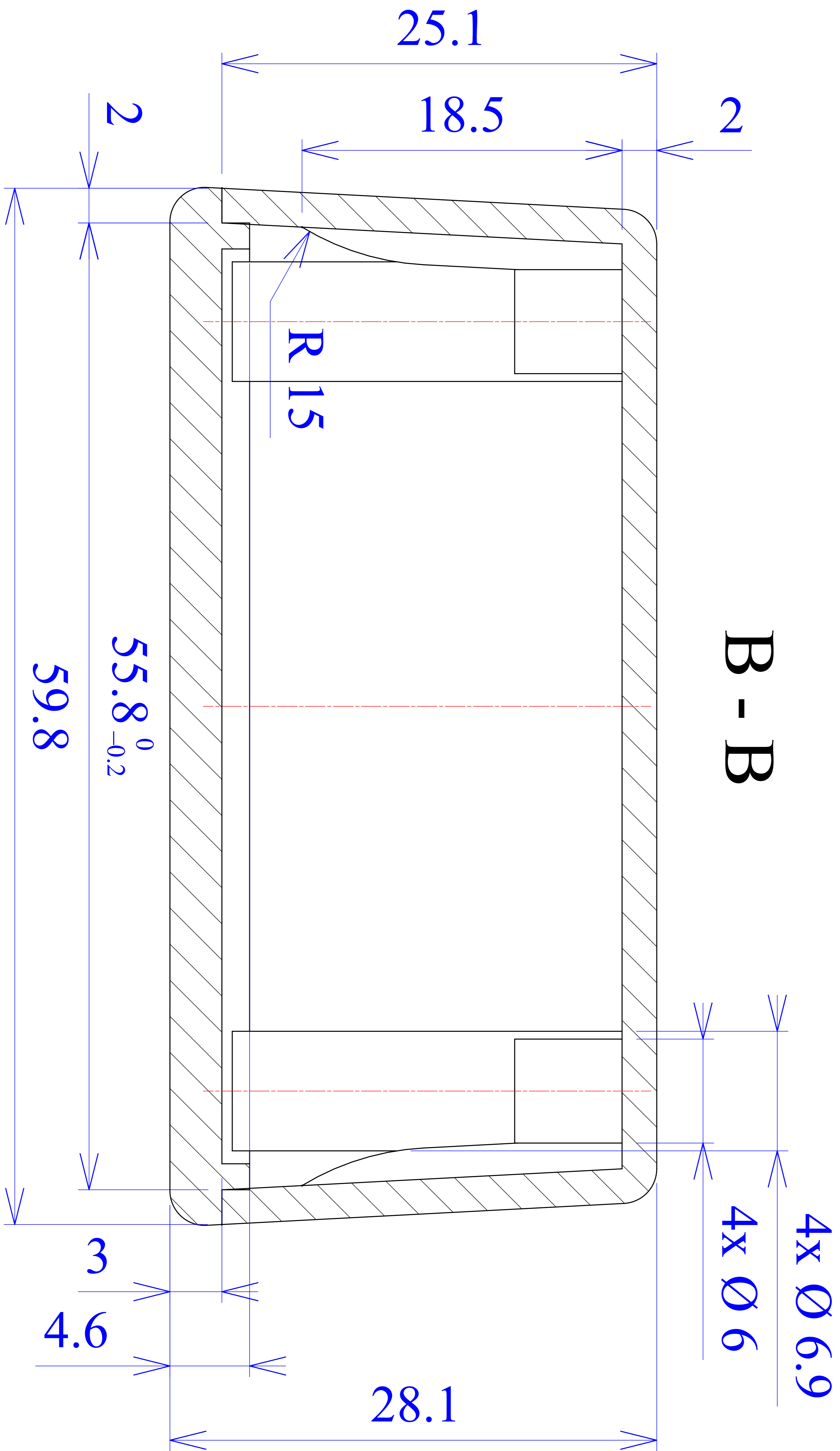

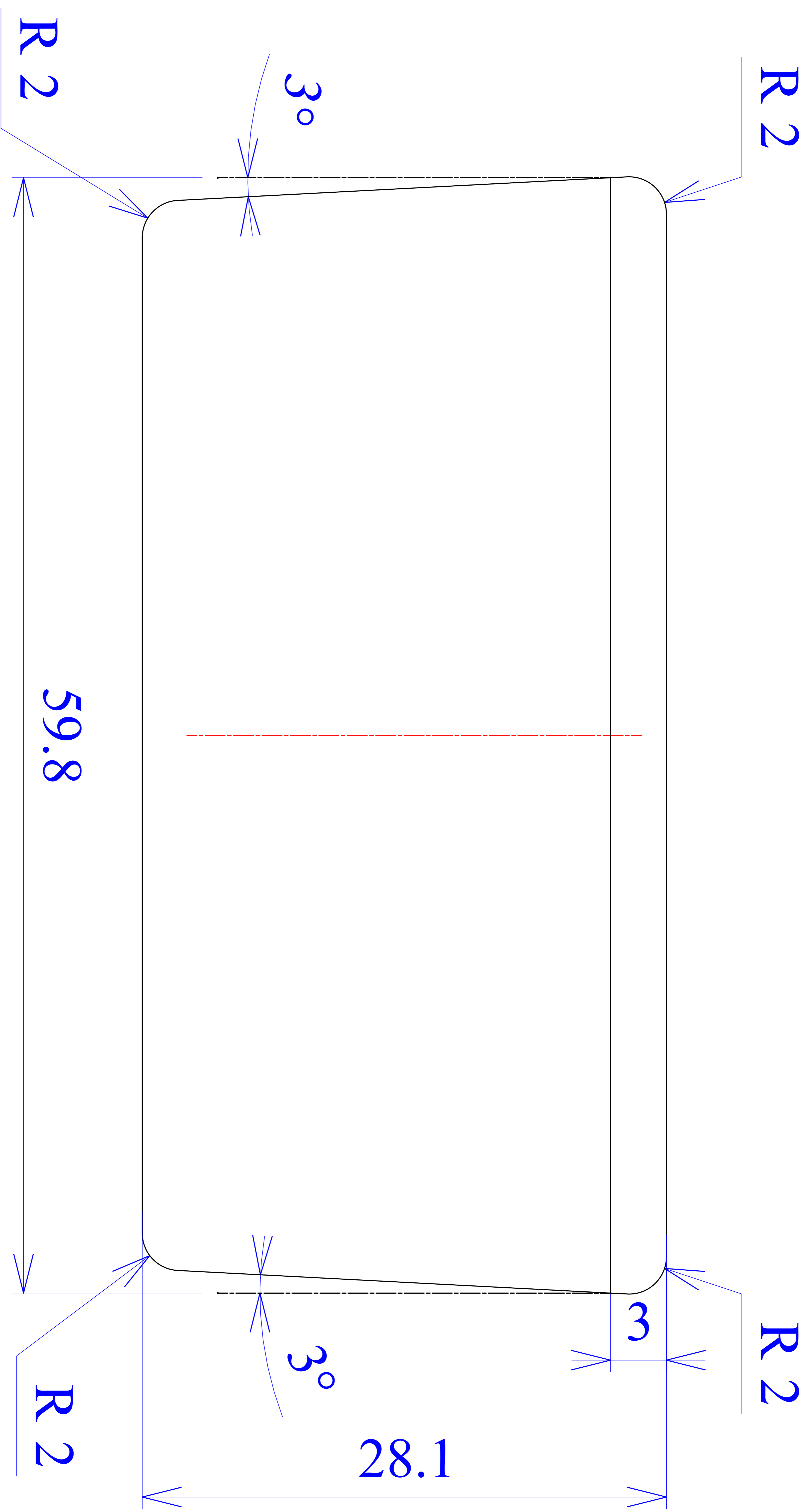

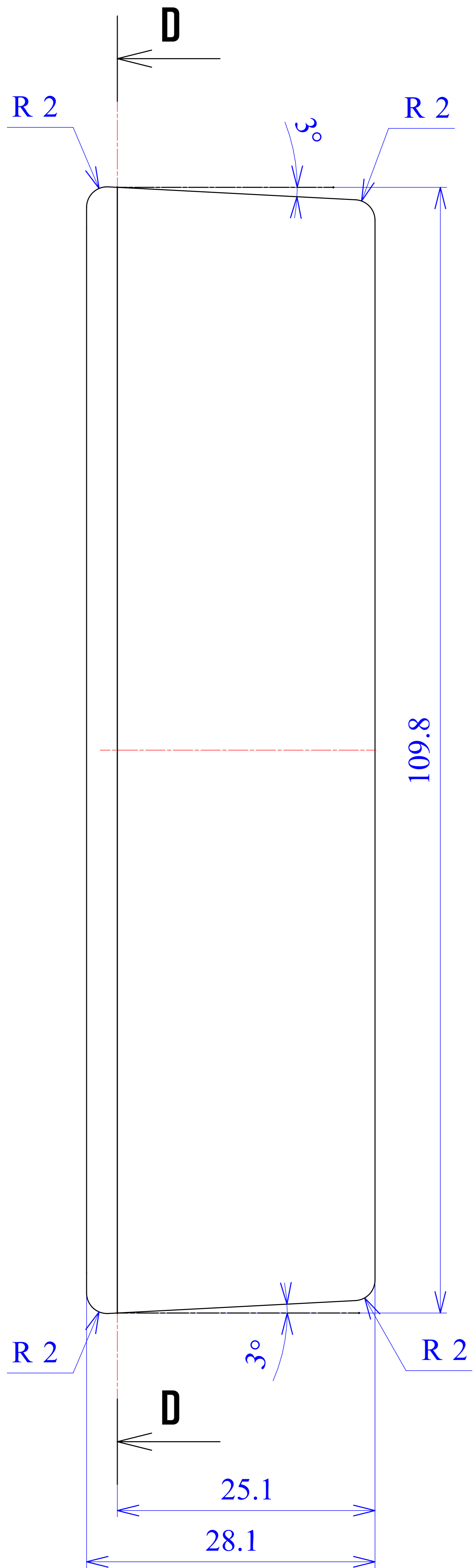

4x Ø 7

4x Ø 4

4x Ø 3.4

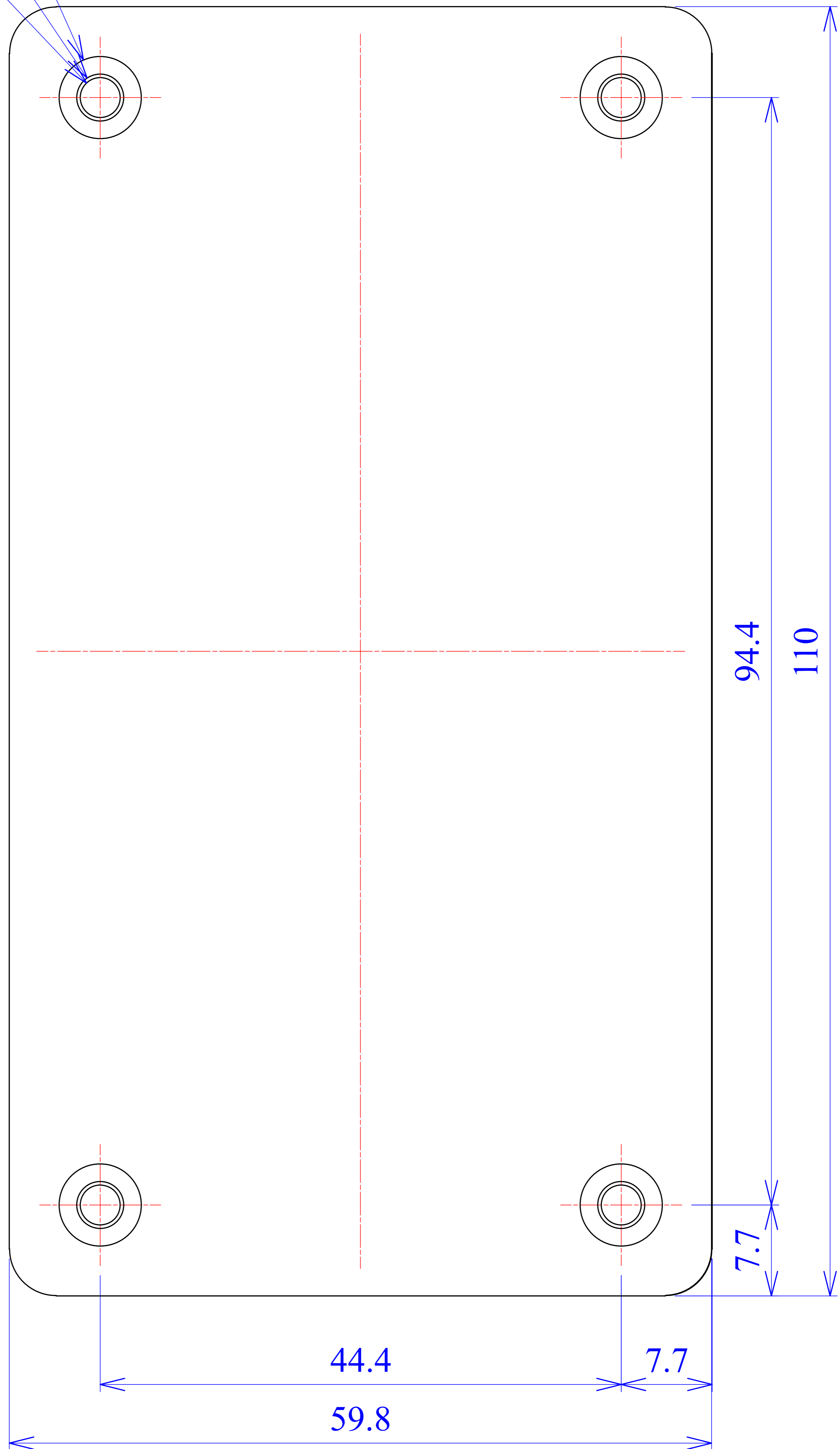

4x Ø 6.9

4x Ø 3.4

C - C

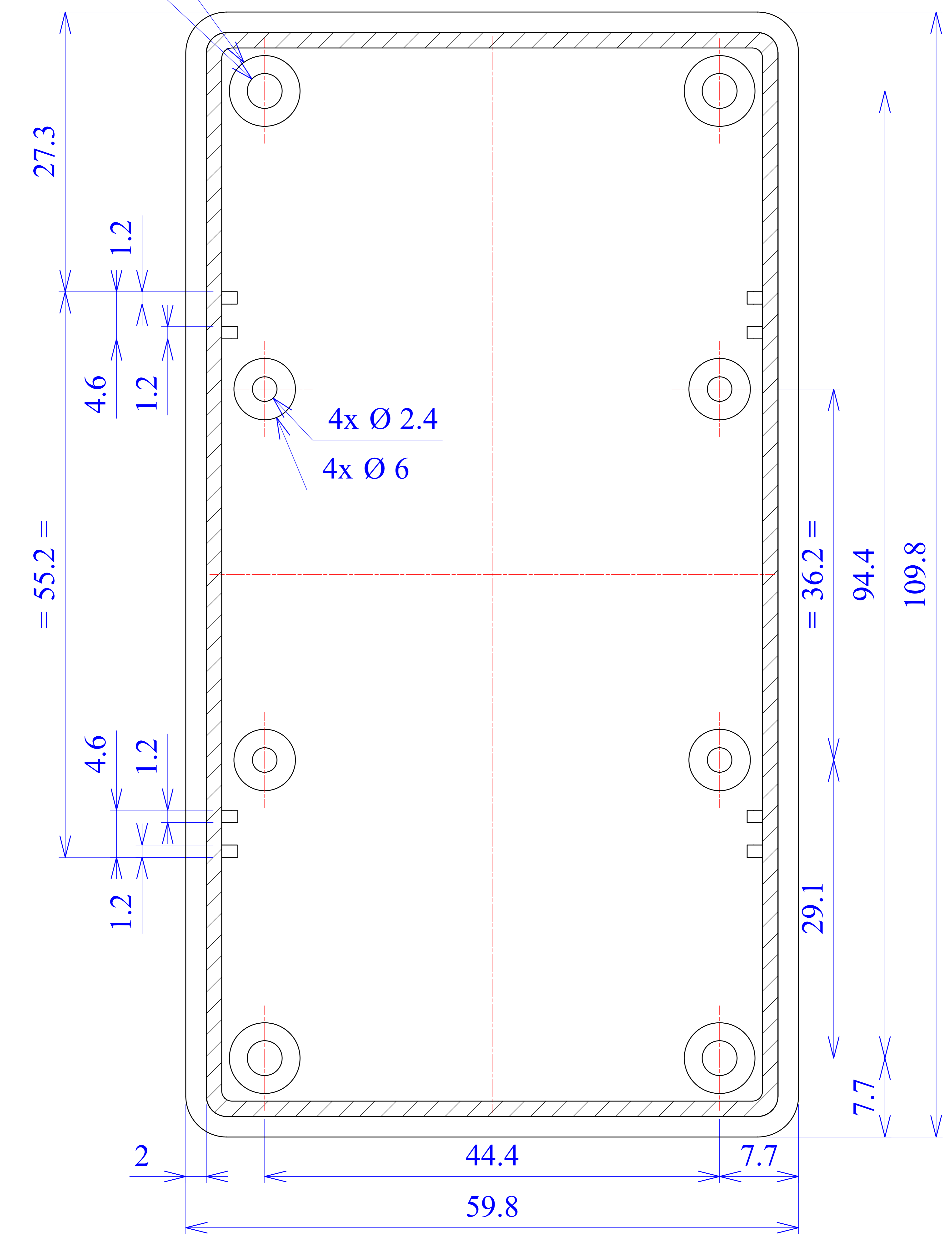

D - D

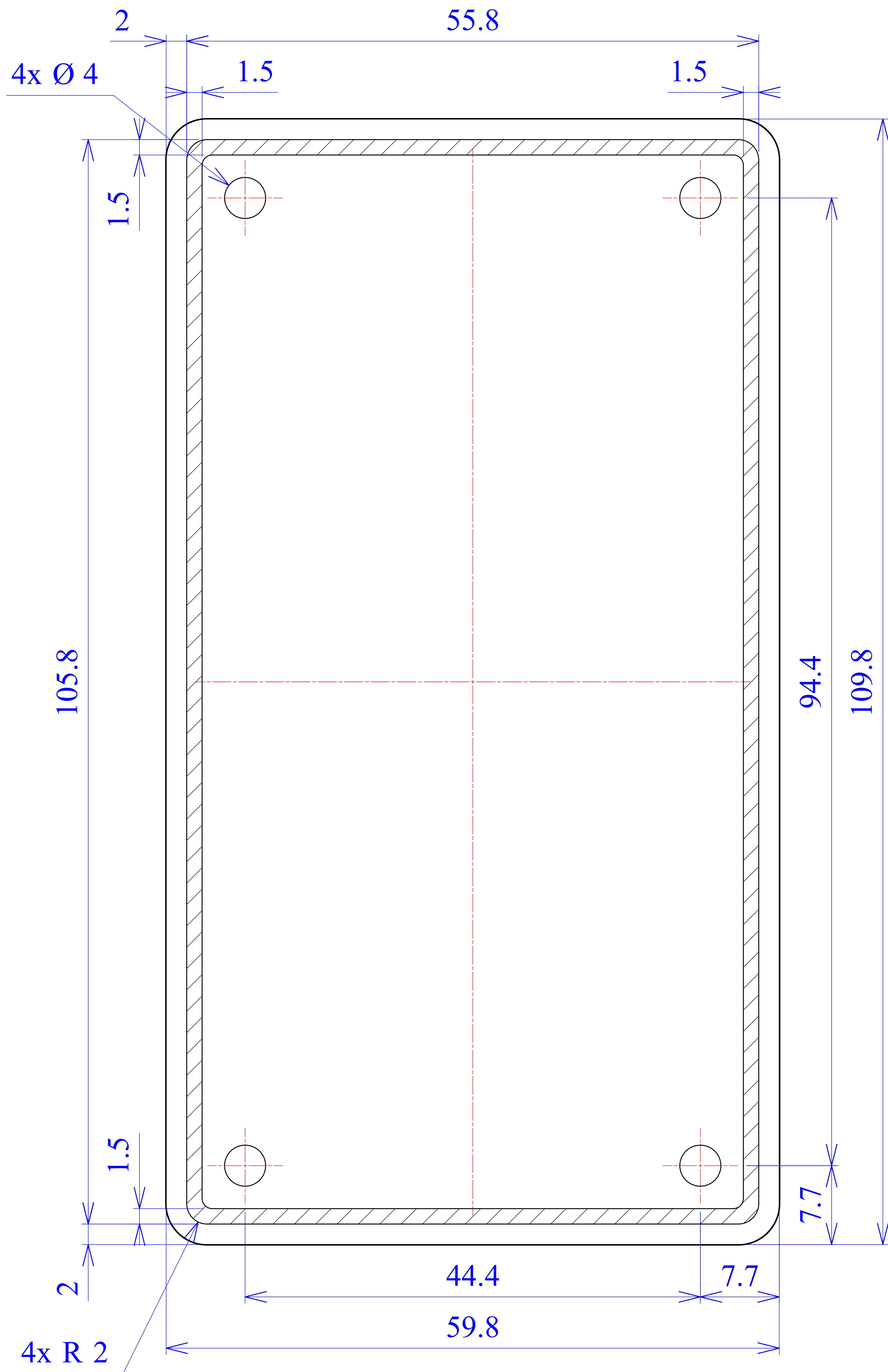

## X-ON Electronics

Largest Supplier of Electrical and Electronic Components

*Click to view similar products for [Enclosures, Boxes, & Cases](#) category:*

*Click to view products by [Kradex](#) manufacturer:*

Other Similar products are found below :

[CR-425 PAINTED](#) [585-R-WH-PK](#) [M-10-PLATED](#) [60221-01](#) [60566-01-000](#) [HPL-9VB BATT DOOR](#) [M-16-LID-PLATED](#) [M18-PLTD](#) [M-21-LID-PLATED](#) [M-21-PLATED](#) [M-23-PLATED](#) [CU-281-MB](#) [6711GSKT](#) [71884-29-028](#) [LH45-100 Black](#) [7200B](#) [72868-510-000](#) [CNS-0000 Black](#) [72883-510-000](#) [CNS-0101 Black](#) [72906-510-000](#) [CNS-0407 Black](#) [73091-510-000](#) [CNM-0000-BLACK Kit](#) [73092-510-000](#) [CNM-0101 Black](#) [73108-510-000](#) [CNL-0303 Black](#) [73395-510-039](#) [CNS-0006 Bone](#) [74257-510-000](#) [CNL-0004](#) [MDC-1183-PLAIN-ALUM](#) [MDC-1183-PTD](#) [MDC-13104-PLAIN-ALUM](#) [MDC-211 - PAINTED IVORY/BEIGE](#) [MDC-321-PTD](#) [MDC-432-PLAIN-ALUM](#) [MDC-973-PTD](#) [76](#) [77153-01-028](#) [FLX6030](#) [83535-01-508](#) [PS-11296-G](#) [PS-11298-B](#) [116-508](#) [120-407](#) [120-412](#) [120-909](#) [120-455](#) [R272-100-000](#) [120-910](#) [R501-001-010](#) [R508-080-000](#) [R508-160-000](#) [R530-120-000](#) [R530-122-000](#) [R530-200-000](#) [R531-160-000](#) [R531-200-000](#) [R582-080-100](#)