

## Medium Power Phase Control Thyristors (Stud Version), 50 A



TO-208AC (TO-65)

### FEATURES

- High current rating
- Excellent dynamic characteristics
- $dV/dt = 1000 \text{ V}/\mu\text{s}$  option
- Superior surge capabilities
- Standard package
- Metric threads version available
- Types up to 1200 V  $V_{\text{DRM}}/V_{\text{RRM}}$
- Material categorization: For definitions of compliance please see [www.vishay.com/doc?99912](http://www.vishay.com/doc?99912)

**RoHS**  
COMPLIANT

PRODUCT SUMMARY	
Package	TO-208AC (TO-65)
Diode variation	Single SCR
$I_{\text{T(AV)}}$	50 A
$V_{\text{DRM}}/V_{\text{RRM}}$	100 V to 1200 V
$V_{\text{TM}}$	1.60 V
$I_{\text{GT}}$	100 mA
$T_{\text{J}}$	- 40 °C to 125 °C

### TYPICAL APPLICATIONS

- Phase control applications in converters
- Lighting circuits
- Battery charges
- Regulated power supplies and temperature and speed control circuit
- Can be supplied to meet stringent military, aerospace and other high reliability requirements

MAJOR RATINGS AND CHARACTERISTICS			
PARAMETER	TEST CONDITIONS	VALUES	UNITS
$I_{\text{T(AV)}}$		50	A
	$T_{\text{C}}$	94	°C
$I_{\text{T(RMS)}}$		80	A
$I_{\text{TSM}}$	50 Hz	1430	A
	60 Hz	1490	
$I^2t$	50 Hz	10.18	kA <sup>2</sup> s
	60 Hz	9.30	
$V_{\text{DRM}}/V_{\text{RRM}}$		100 to 1200	V
$t_{\text{q}}$	Typical	110	$\mu\text{s}$
$T_{\text{J}}$		- 40 to 125	°C

### ELECTRICAL SPECIFICATIONS

VOLTAGE RATINGS				
TYPE NUMBER	VOLTAGE CODE	$V_{\text{DRM}}/V_{\text{RRM}}$ , MAXIMUM REPETITIVE PEAK AND OFF-STATE VOLTAGE <sup>(1)</sup> V	$V_{\text{RSM}}$ , MAXIMUM NON-REPETITIVE PEAK VOLTAGE <sup>(2)</sup> V	$I_{\text{DRM}}/I_{\text{RRM}}$ MAXIMUM AT $T_{\text{J}} = T_{\text{J}}$ MAXIMUM mA
50RIA	10	100	150	15
	20	200	300	
	40	400	500	
	60	600	700	
	80	800	900	
	100	1000	1100	
	120	1200	1300	

#### Notes

<sup>(1)</sup> Units may be broken over non-repetitively in the off-state direction without damage, if  $dI/dt$  does not exceed 20 A/ $\mu\text{s}$

<sup>(2)</sup> For voltage pulses with  $t_{\text{p}} \leq 5 \text{ ms}$



ABSOLUTE MAXIMUM RATINGS					
PARAMETER	SYMBOL	TEST CONDITIONS		VALUES	UNITS
Maximum average on-state current at case temperature	$I_{T(AV)}$	180° sinusoidal conduction		50	A
				94	°C
Maximum RMS on-state current	$I_{T(RMS)}$			80	A
Maximum peak, one-cycle non-repetitive surge current	$I_{TSM}$	t = 10 ms	No voltage reappplied	Sinusoidal half wave, initial $T_J = T_J$ maximum	A
		t = 8.3 ms			
		t = 10 ms	100 % $V_{RRM}$ reappplied		
		t = 8.3 ms			
Maximum $I^2t$ for fusing	$I^2t$	t = 10 ms	No voltage reappplied		kA <sup>2</sup> s
		t = 8.3 ms			
		t = 10 ms	100 % $V_{RRM}$ reappplied		
		t = 8.3 ms			
Maximum $I^2\sqrt{t}$ for fusing	$I^2\sqrt{t}$	t = 0.1 to 10 ms, no voltage reappplied, $T_J = T_J$ maximum		101.8	kA <sup>2</sup> √s
Low level value of threshold voltage	$V_{T(TO)1}$	$(16.7\% \times \pi \times I_{T(AV)} < I < \pi \times I_{T(AV)})$ , $T_J = T_J$ maximum		0.94	V
High level value of threshold voltage	$V_{T(TO)2}$	$(\pi \times I_{T(AV)} < I < 20 \times \pi \times I_{T(AV)})$ , $T_J = T_J$ maximum		1.08	
Low level value of on-state slope resistance	$r_{t1}$	$(16.7\% \times \pi \times I_{T(AV)} < I < \pi \times I_{T(AV)})$ , $T_J = T_J$ maximum		4.08	mΩ
High level value of on-state slope resistance	$r_{t2}$	$(\pi \times I_{T(AV)} < I < 20 \times \pi \times I_{T(AV)})$ , $T_J = T_J$ maximum		3.34	
Maximum on-state voltage	$V_{TM}$	$I_{pk} = 157$ A, $T_J = 25$ °C		1.60	V
Maximum holding current	$I_H$	$T_J = 25$ °C, anode supply 22 V, resistive load, initial $I_T = 2$ A		200	mA
Latching current	$I_L$	Anode supply 6 V, resistive load		400	

SWITCHING					
PARAMETER	SYMBOL	TEST CONDITIONS		VALUES	UNITS
Maximum rate of rise of turned-on current	dI/dt	$T_C = 125$ °C, $V_{DM} =$ Rated $V_{DRM}$ , Gate pulse = 20 V, 15 Ω, $t_p = 6$ μs, $t_r = 0.1$ μs maximum $I_{TM} = (2 \times \text{rated } dI/dt)$ A		200	A/μs
				$V_{DRM} \leq 600$ V	
Typical delay time	$t_d$	$T_C = 25$ °C, $V_{DM} =$ Rated $V_{DRM}$ , $I_{TM} = 10$ A dc resistive circuit Gate pulse = 10 V, 15 Ω source, $t_p = 20$ μs		0.9	μs
Typical turn-off time	$t_q$	$T_C = 125$ °C, $I_{TM} = 50$ A, reappplied $dV/dt = 20$ V/μs $dI_r/dt = -10$ A/μs, $V_R = 50$ V		110	

BLOCKING					
PARAMETER	SYMBOL	TEST CONDITIONS		VALUES	UNITS
Maximum critical rate of rise of off-state voltage	dV/dt	$T_J = T_J$ maximum linear to 100 % rated $V_{DRM}$		200	V/μs
		$T_J = T_J$ maximum linear to 67 % rated $V_{DRM}$		500 <sup>(1)</sup>	

Note

<sup>(1)</sup> Available with  $dV/dt = 1000$  V/μs, to complete code add S90 i.e. 50RIA120S90



TRIGGERING					
PARAMETER	SYMBOL	TEST CONDITIONS		VALUES	UNITS
Maximum peak gate power	$P_{GM}$	$T_J = T_J$ maximum, $t_p \leq 5$ ms		10	W
Maximum average gate power	$P_{G(AV)}$			2.5	
Maximum peak positive gate current	$I_{GM}$			2.5	A
Maximum peak positive gate voltage	$+V_{GM}$			20	V
Maximum peak negative gate voltage	$-V_{GM}$			10	
DC gate current required to trigger	$I_{GT}$	$T_J = -40$ °C	Maximum required gate trigger current/voltage are the lowest value which will trigger all units 6 V anode to cathode applied	250	mA
		$T_J = 25$ °C		100	
		$T_J = 125$ °C		50	
DC gate voltage required to trigger	$V_{GT}$	$T_J = -40$ °C		3.5	V
		$T_J = 25$ °C		2.5	
DC gate current not to trigger	$I_{GD}$	$T_J = T_J$ maximum, $V_{DRM} =$ Rated voltage		Maximum gate current/voltage not to trigger is the maximum value which will not trigger any unit with rated $V_{DRM}$ anode to cathode applied	5.0
DC gate voltage not to trigger	$V_{GD}$	$T_J = T_J$ maximum	0.2		V

THERMAL AND MECHANICAL SPECIFICATIONS					
PARAMETER	SYMBOL	TEST CONDITIONS		VALUES	UNITS
Maximum operating junction and storage temperature range	$T_J, T_{Stg}$			- 40 to 125	°C
Maximum thermal resistance, junction to case	$R_{thJC}$	DC operation		0.35	K/W
Maximum thermal resistance, case to heatsink	$R_{thCS}$	Mounting surface, smooth, flat and greased		0.25	
Allowable mounting torque		Non-lubricated threads		$3.4^{+0-10}$ % (30)	N · m (lbf · in)
		Lubricated threads		$2.3^{+0-10}$ % (20)	
Approximate weight				28	g
				1.0	oz.
Case style		See dimensions - link at the end of datasheet		TO-208AC (TO-65)	

$\Delta R_{thJC}$ CONDUCTION				
CONDUCTION ANGLE	SINUSOIDAL CONDUCTION	RECTANGULAR CONDUCTION	TEST CONDITIONS	UNITS
180°	0.078	0.057	$T_J = T_J$ maximum	K/W
120°	0.094	0.098		
90°	0.120	0.130		
60°	0.176	0.183		
30°	0.294	0.296		

**Note**

- The table above shows the increment of thermal resistance  $R_{thJC}$  when devices operate at different conduction angles than DC

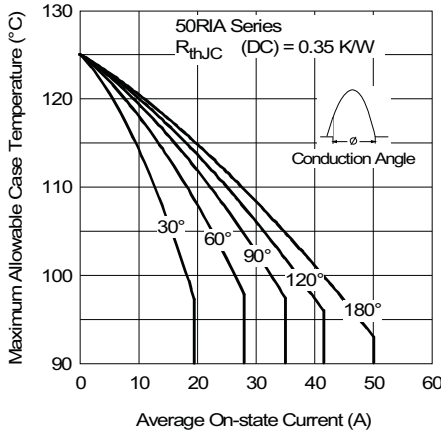

Fig. 1 - Current Ratings Characteristics

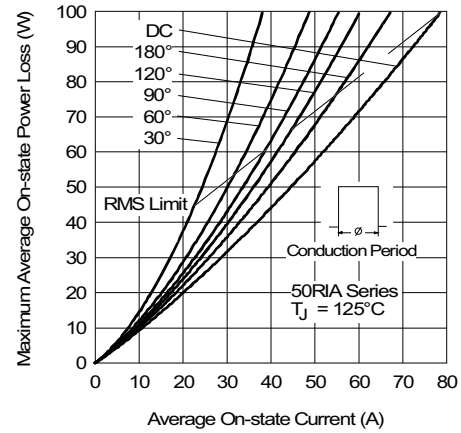

Fig. 4 - On-State Power Loss Characteristics

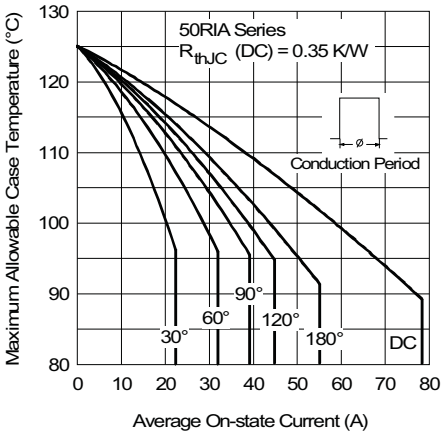

Fig. 2 - Current Ratings Characteristics

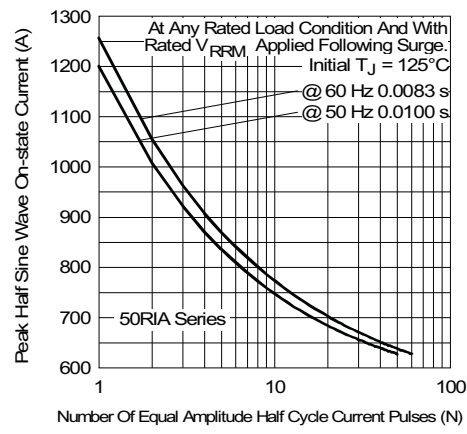

Fig. 5 - Maximum Non-Repetitive Surge Current

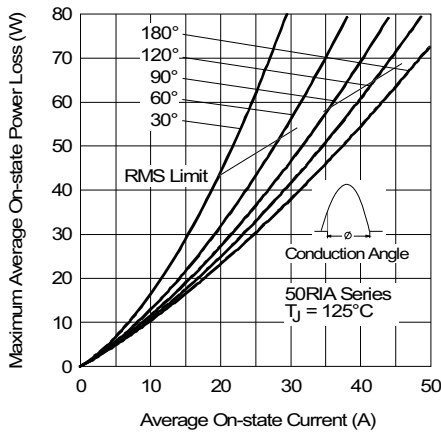

Fig. 3 - On-State Power Loss Characteristics

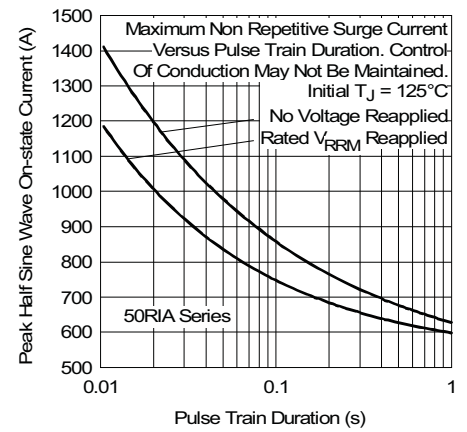

Fig. 6 - Maximum Non-Repetitive Surge Current

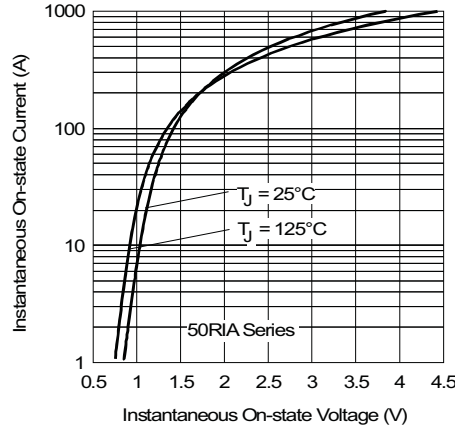

Fig. 7 - Forward Voltage Drop Characteristics

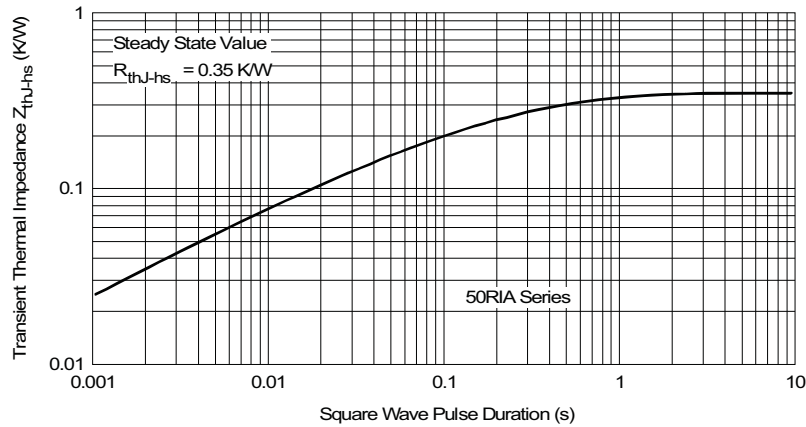

Fig. 8 - Thermal Impedance  $Z_{thJc}$  Characteristics

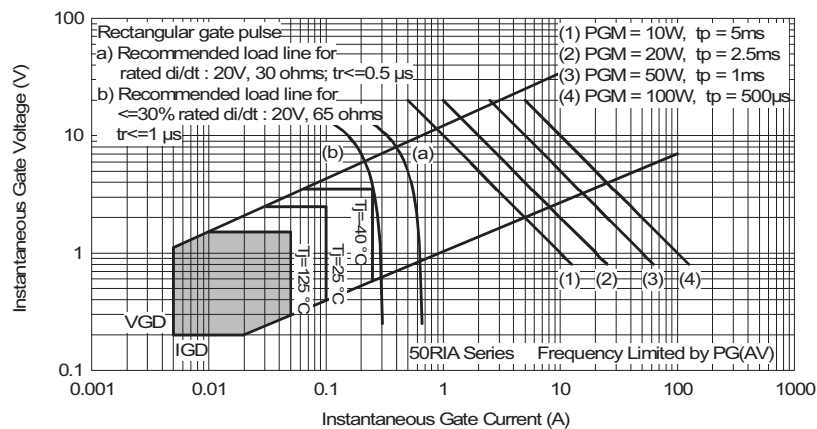
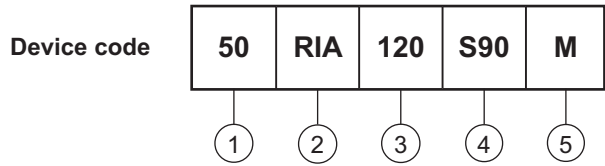

Fig. 9 - Gate Characteristics



**ORDERING INFORMATION TABLE**



- 1** - Current code
- 2** - Essential part number
- 3** - Voltage code x 10 =  $V_{RRM}$  (see Voltage Ratings table)
- 4** - Critical dV/dt:
  - None = 500 V/ $\mu$ s (standard value)
  - S90 = 1000 V/ $\mu$ s (special selection)
- 5** -
  - None = Stud base TO-208AC (TO-65) 1/4" 28UNF-2A
  - M = Stud base TO-208AC (TO-65) M6 x 1

LINKS TO RELATED DOCUMENTS	
Dimensions	<a href="http://www.vishay.com/doc?95334">www.vishay.com/doc?95334</a>

## TO-208AC (TO-65)

**DIMENSIONS** in millimeters (inches)

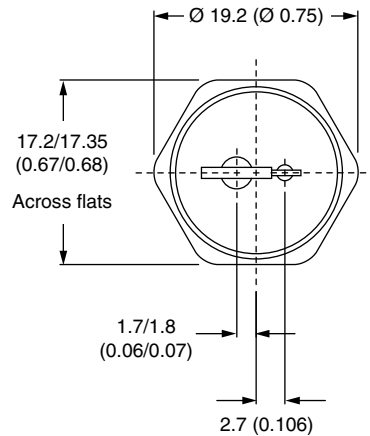
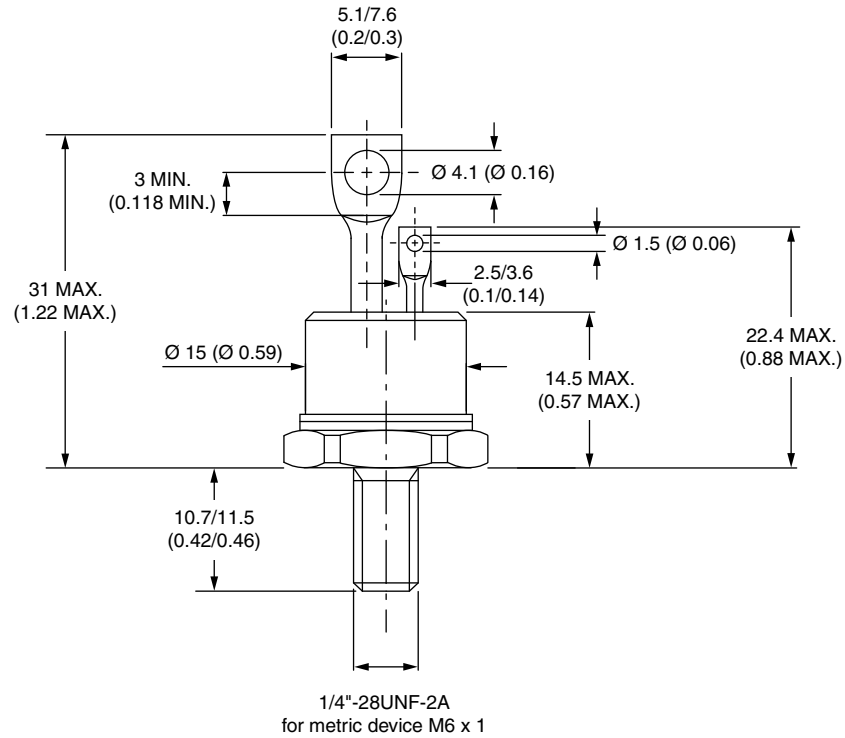



## Disclaimer

ALL PRODUCT, PRODUCT SPECIFICATIONS AND DATA ARE SUBJECT TO CHANGE WITHOUT NOTICE TO IMPROVE RELIABILITY, FUNCTION OR DESIGN OR OTHERWISE.

Vishay Intertechnology, Inc., its affiliates, agents, and employees, and all persons acting on its or their behalf (collectively, "Vishay"), disclaim any and all liability for any errors, inaccuracies or incompleteness contained in any datasheet or in any other disclosure relating to any product.

Vishay makes no warranty, representation or guarantee regarding the suitability of the products for any particular purpose or the continuing production of any product. To the maximum extent permitted by applicable law, Vishay disclaims (i) any and all liability arising out of the application or use of any product, (ii) any and all liability, including without limitation special, consequential or incidental damages, and (iii) any and all implied warranties, including warranties of fitness for particular purpose, non-infringement and merchantability.

Statements regarding the suitability of products for certain types of applications are based on Vishay's knowledge of typical requirements that are often placed on Vishay products in generic applications. Such statements are not binding statements about the suitability of products for a particular application. It is the customer's responsibility to validate that a particular product with the properties described in the product specification is suitable for use in a particular application. Parameters provided in datasheets and/or specifications may vary in different applications and performance may vary over time. All operating parameters, including typical parameters, must be validated for each customer application by the customer's technical experts. Product specifications do not expand or otherwise modify Vishay's terms and conditions of purchase, including but not limited to the warranty expressed therein.

Except as expressly indicated in writing, Vishay products are not designed for use in medical, life-saving, or life-sustaining applications or for any other application in which the failure of the Vishay product could result in personal injury or death. Customers using or selling Vishay products not expressly indicated for use in such applications do so at their own risk. Please contact authorized Vishay personnel to obtain written terms and conditions regarding products designed for such applications.

No license, express or implied, by estoppel or otherwise, to any intellectual property rights is granted by this document or by any conduct of Vishay. Product names and markings noted herein may be trademarks of their respective owners.

## Material Category Policy

**Vishay Intertechnology, Inc. hereby certifies that all its products that are identified as RoHS-Compliant fulfill the definitions and restrictions defined under Directive 2011/65/EU of The European Parliament and of the Council of June 8, 2011 on the restriction of the use of certain hazardous substances in electrical and electronic equipment (EEE) - recast, unless otherwise specified as non-compliant.**

**Please note that some Vishay documentation may still make reference to RoHS Directive 2002/95/EC. We confirm that all the products identified as being compliant to Directive 2002/95/EC conform to Directive 2011/65/EU.**

**Vishay Intertechnology, Inc. hereby certifies that all its products that are identified as Halogen-Free follow Halogen-Free requirements as per JEDEC JS709A standards. Please note that some Vishay documentation may still make reference to the IEC 61249-2-21 definition. We confirm that all the products identified as being compliant to IEC 61249-2-21 conform to JEDEC JS709A standards.**



## X-ON Electronics

Largest Supplier of Electrical and Electronic Components

*Click to view similar products for [SCRs category](#):*

*Click to view products by [Vishay manufacturer](#):*

Other Similar products are found below :

[NTE5428](#) [NTE5448](#) [NTE5457](#) [NTE5511](#) [T1500N16TOF VT](#) [T720N18TOF](#) [T880N14TOF](#) [T880N16TOF](#) [TS110-7UF](#) [TT104N12KOF-A](#)  
[TT104N12KOF-K](#) [TT162N16KOF-A](#) [TT162N16KOF-K](#) [TT330N16AOF](#) [VS-16RIA100](#) [VS-22RIA20](#) [VS-2N5206](#) [VS-2N685](#) [VS-](#)  
[40TPS08A-M3](#) [VS-ST230S12P1VPBF](#) [057219R](#) [CLB30I1200HB](#) [T1190N16TOF VT](#) [T1220N22TOF VT](#) [T201N70TOH](#) [T830N18TOF](#)  
[TD92N16KOF-A](#) [TT250N12KOF-K](#) [VS-2N692](#) [VS-2N689](#) [VS-25RIA40](#) [VS-16RIA120](#) [VS-10RIA120](#) [VS-30TPS08PBF](#) [NTE5427](#)  
[NTE5442](#) [VS-2N690](#) [VS-ST300S20P0PBF](#) [TT251N16KOF-K](#) [VS-22RIA100](#) [VS-16RIA40](#) [CR02AM-8#F00](#) [VS-ST110S12P0VPBF](#)  
[TD250N16KOF-A](#) [VS-ST110S16P0](#) [VS-10RIA10](#) [VS-16TTS08-M3](#) [TS110-7A1-AP](#) [T930N36TOF VT](#) [T2160N24TOF VT](#)