



Inductors for High Frequency Circuits

Multilayer Ceramic

MHQ-P series

MHQ0402P	0402 [01005 inch]*
MHQ0603P	0603 [0201 inch]
MHQ1005P	1005 [0402 inch]

* Dimensions Code JIS[EIA]

REMINDERS FOR USING THESE PRODUCTS

Before using these products, be sure to request the delivery specifications.

SAFETY REMINDERS

Please pay sufficient attention to the warnings for safe designing when using these products.

REMINDERS

- The storage period is less than 12 months. Be sure to follow the storage conditions (Temperature: 5 to 40°C, Humidity: 10 to 75% RH or less).
If the storage period elapses, the soldering of the terminal electrodes may deteriorate.
- Do not use or store in locations where there are conditions such as gas corrosion (salt, acid, alkali, etc.).
- Before soldering, be sure to preheat components.
The preheating temperature should be set so that the temperature difference between the solder temperature and chip temperature does not exceed 150°C.
- Soldering corrections after mounting should be within the range of the conditions determined in the specifications.
If overheated, a short circuit, performance deterioration, or lifespan shortening may occur.
- When embedding a printed circuit board where a chip is mounted to a set, be sure that residual stress is not given to the chip due to the overall distortion of the printed circuit board and partial distortion such as at screw tightening portions.
- Self heating (temperature increase) occurs when the power is turned ON, so the tolerance should be sufficient for the set thermal design.
- Carefully lay out the coil for the circuit board design of the non-magnetic shield type.
A malfunction may occur due to magnetic interference.
- Use a wrist band to discharge static electricity in your body through the grounding wire.
- Do not expose the products to magnets or magnetic fields.
- Do not use for a purpose outside of the contents regulated in the delivery specifications.
- The products listed on this catalog are intended for use in general electronic equipment (AV equipment, telecommunications equipment, home appliances, amusement equipment, computer equipment, personal equipment, office equipment, measurement equipment, industrial robots) under a normal operation and use condition.
The products are not designed or warranted to meet the requirements of the applications listed below, whose performance and/or quality require a more stringent level of safety or reliability, or whose failure, malfunction or trouble could cause serious damage to society, person or property.
If you intend to use the products in the applications listed below or if you have special requirements exceeding the range or conditions set forth in the each catalog, please contact us.

(1) Aerospace/Aviation equipment
 (2) Transportation equipment (cars, electric trains, ships, etc.)
 (3) Medical equipment
 (4) Power-generation control equipment
 (5) Atomic energy-related equipment
 (6) Seabed equipment
 (7) Transportation control equipment

(8) Public information-processing equipment
 (9) Military equipment
 (10) Electric heating apparatus, burning equipment
 (11) Disaster prevention/crime prevention equipment
 (12) Safety equipment
 (13) Other applications that are not considered general-purpose applications

When designing your equipment even for general-purpose applications, you are kindly requested to take into consideration securing protection circuit/device or providing backup circuits in your equipment.

Inductors for High Frequency Circuits

Multilayer Ceramic

Product compatible with RoHS directive
Halogen-free
Compatible with lead-free solders

Overview of the MHQ-P Series

FEATURES

- Unique ceramic material and configuration allows for the realization of high Q characteristics that are equivalent to that of air core wound inductors.
- Multilayer method allows for a lineup with fine increments of inductance.

APPLICATION

Smart phones, tablet terminals, high frequency modules (PAs, VCOs, FEMs , etc.), Bluetooth, W-LAN, UWB, tuners and other high frequency circuits for the mobile communication industry

PART NUMBER CONSTRUCTION

Series name	LxWxH Dimensions (mm)		Characteristics	Inductance (nH)		Inductance tolerance		Packaging style		Internal code
MHQ	0603	P	ON6	S	T	000				
	0402	0.44x0.24x0.24	P	0N6	0.6	B	±0.1nH	T	Taping	000
	0603	0.65x0.35x0.35		1N1	1.1	C	±0.2nH			
	1005	1.0x0.6x0.5		11N	11	S	±0.3nH			
						G	±2%			
						H	±3%			
						J	±5%			

OPERATING TEMPERATURE RANGE, PACKAGE QUANTITY, PRODUCT WEIGHT

Type	Temperature range		Package quantity	Individual weight
	Operating temperature	Storage temperature*		
	(°C)	(°C)	(pieces/reel)	(mg)
MHQ0402P	-55 to +125	-55 to +125	20000	0.11
MHQ0603P	-55 to +125	-55 to +125	15000	0.2
MHQ1005P	-55 to +125	-55 to +125	10000	1

* The Storage temperature range is for after the circuit board is mounted.

- RoHS Directive Compliant Product: See the following for more details related to RoHS Directive compliant products. <http://product.tdk.com/en/environment/rohs/>
- Halogen-free: Indicates that Cl content is less than 900ppm, Br content is less than 900ppm, and that the total Cl and Br content is less than 1500ppm.

 Please be sure to request delivery specifications that provide further details on the features and specifications of the products for proper and safe use. Please note that the contents may change without any prior notice due to reasons such as upgrading.

Overview of the MHQ-P Series

RECOMMENDED REFLOW PROFILE

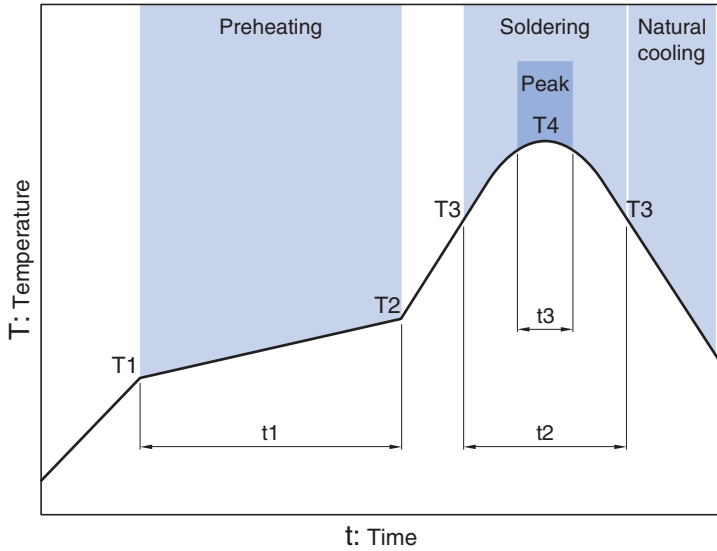

Preheating			Soldering		Peak	
Temp.		Time	Temp.	Time	Temp.	Time
T1	T2	t1	T3	t2	T4	t3
150°C	180°C	60 to 120s	230°C	30 to 60s	250 to 260°C	10s max.

 Please be sure to request delivery specifications that provide further details on the features and specifications of the products for proper and safe use. Please note that the contents may change without any prior notice due to reasons such as upgrading.

MHQ-P_{series}

MHQ0402P Type



■ SHAPE & DIMENSIONS

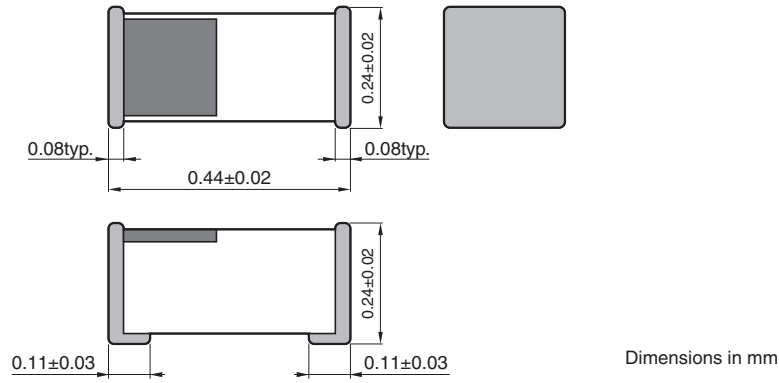

■ RECOMMENDED LAND PATTERN

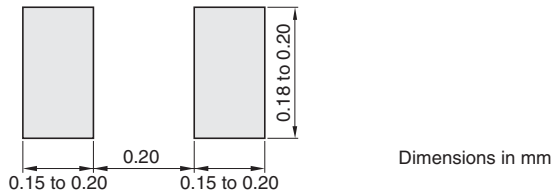

 Please be sure to request delivery specifications that provide further details on the features and specifications of the products for proper and safe use. Please note that the contents may change without any prior notice due to reasons such as upgrading.

MHQ-P_{series} **MHQ0402P Type**

■ ELECTRICAL CHARACTERISTICS

□ CHARACTERISTICS SPECIFICATION TABLE

L (nH)	Tolerance	L measuring frequency (MHz)	Q min.	Q measuring frequency (MHz)	Self-resonant frequency (GHz)		DC resistance (Ω)		Rated current (mA) max.	Part No.
					min.	typ.	max.	typ.		
0.2	± 0.1 nH	500	—	500	10.0	18.7	0.2	0.02	320	MHQ0402P0N2BT000
0.2	± 0.2 nH	500	—	500	10.0	18.7	0.2	0.02	320	MHQ0402P0N2CT000
0.3	± 0.1 nH	500	—	500	10.0	18.6	0.2	0.04	320	MHQ0402P0N3BT000
0.3	± 0.2 nH	500	—	500	10.0	18.6	0.2	0.04	320	MHQ0402P0N3CT000
0.4	± 0.1 nH	500	—	500	10.0	18.8	0.2	0.09	320	MHQ0402P0N4BT000
0.4	± 0.2 nH	500	—	500	10.0	18.8	0.2	0.09	320	MHQ0402P0N4CT000
0.4	± 0.3 nH	500	—	500	10.0	18.8	0.2	0.09	320	MHQ0402P0N4ST000
0.5	± 0.1 nH	500	—	500	10.0	18.8	0.2	0.05	320	MHQ0402P0N5BT000
0.5	± 0.2 nH	500	—	500	10.0	18.8	0.2	0.05	320	MHQ0402P0N5CT000
0.5	± 0.3 nH	500	—	500	10.0	18.8	0.2	0.05	320	MHQ0402P0N5ST000
0.6	± 0.1 nH	500	—	500	10.0	18.8	0.2	0.07	320	MHQ0402P0N6BT000
0.6	± 0.2 nH	500	—	500	10.0	18.8	0.2	0.07	320	MHQ0402P0N6CT000
0.6	± 0.3 nH	500	—	500	10.0	18.8	0.2	0.07	320	MHQ0402P0N6ST000
0.7	± 0.1 nH	500	—	500	10.0	18.8	0.2	0.09	320	MHQ0402P0N7BT000
0.7	± 0.2 nH	500	—	500	10.0	18.8	0.2	0.09	320	MHQ0402P0N7CT000
0.7	± 0.3 nH	500	—	500	10.0	18.8	0.2	0.09	320	MHQ0402P0N7ST000
0.8	± 0.1 nH	500	—	500	10.0	17.8	0.2	0.07	320	MHQ0402P0N8BT000
0.8	± 0.2 nH	500	—	500	10.0	17.8	0.2	0.07	320	MHQ0402P0N8CT000
0.8	± 0.3 nH	500	—	500	10.0	17.8	0.2	0.07	320	MHQ0402P0N8ST000
0.9	± 0.1 nH	500	—	500	10.0	16.8	0.2	0.11	320	MHQ0402P0N9BT000
0.9	± 0.2 nH	500	—	500	10.0	16.8	0.2	0.11	320	MHQ0402P0N9CT000
0.9	± 0.3 nH	500	—	500	10.0	16.8	0.2	0.11	320	MHQ0402P0N9ST000
1.0	± 0.1 nH	500	10	500	10.0	14.0	0.2	0.11	320	MHQ0402P1N0BT000
1.0	± 0.2 nH	500	10	500	10.0	14.0	0.2	0.11	320	MHQ0402P1N0CT000
1.0	± 0.3 nH	500	10	500	10.0	14.0	0.2	0.11	320	MHQ0402P1N0ST000
1.1	± 0.1 nH	500	10	500	9.0	12.4	0.2	0.11	320	MHQ0402P1N1BT000
1.1	± 0.2 nH	500	10	500	9.0	12.4	0.2	0.11	320	MHQ0402P1N1CT000
1.1	± 0.3 nH	500	10	500	9.0	12.4	0.2	0.11	320	MHQ0402P1N1ST000
1.2	± 0.1 nH	500	10	500	9.0	11.8	0.2	0.12	320	MHQ0402P1N2BT000
1.2	± 0.2 nH	500	10	500	9.0	11.8	0.2	0.12	320	MHQ0402P1N2CT000
1.2	± 0.3 nH	500	10	500	9.0	11.8	0.2	0.12	320	MHQ0402P1N2ST000
1.3	± 0.1 nH	500	10	500	8.0	11.3	0.2	0.12	320	MHQ0402P1N3BT000
1.3	± 0.2 nH	500	10	500	8.0	11.3	0.2	0.12	320	MHQ0402P1N3CT000
1.3	± 0.3 nH	500	10	500	8.0	11.3	0.2	0.12	320	MHQ0402P1N3ST000
1.4	± 0.1 nH	500	10	500	8.0	11.0	0.3	0.12	320	MHQ0402P1N4BT000
1.4	± 0.2 nH	500	10	500	8.0	11.0	0.3	0.12	320	MHQ0402P1N4CT000
1.4	± 0.3 nH	500	10	500	8.0	11.0	0.3	0.12	320	MHQ0402P1N4ST000
1.5	± 0.1 nH	500	10	500	8.0	10.8	0.3	0.12	320	MHQ0402P1N5BT000
1.5	± 0.2 nH	500	10	500	8.0	10.8	0.3	0.12	320	MHQ0402P1N5CT000
1.5	± 0.3 nH	500	10	500	8.0	10.8	0.3	0.12	320	MHQ0402P1N5ST000

· Short bar residual inductance =0.11nH

○ Measurement equipment

Measurement item	Product No.	Manufacturer
L, Q	4991A+16196D	Agilent Technologies
Self-resonant frequency	8720C	Agilent Technologies
DC resistance	4338A	Yokogawa

* Equivalent measurement equipment may be used.

MHQ-P_{series} **MHQ0402P Type**

■ ELECTRICAL CHARACTERISTICS

□ CHARACTERISTICS SPECIFICATION TABLE

L (nH)	Tolerance	L measuring frequency (MHz)	Q min.	Q measuring frequency (MHz)	Self-resonant frequency (GHz)		DC resistance (Ω)		Rated current (mA) max.	Part No.
					min.	typ.	max.	typ.		
1.6	±0.1nH	500	10	500	8.0	11.1	0.3	0.14	320	MHQ0402P1N6BT000
1.6	±0.2nH	500	10	500	8.0	11.1	0.3	0.14	320	MHQ0402P1N6CT000
1.6	±0.3nH	500	10	500	8.0	11.1	0.3	0.14	320	MHQ0402P1N6ST000
1.7	±0.1nH	500	10	500	8.0	10.7	0.3	0.15	320	MHQ0402P1N7BT000
1.7	±0.2nH	500	10	500	8.0	10.7	0.3	0.15	320	MHQ0402P1N7CT000
1.7	±0.3nH	500	10	500	8.0	10.7	0.3	0.15	320	MHQ0402P1N7ST000
1.8	±0.1nH	500	10	500	8.0	10.6	0.3	0.19	250	MHQ0402P1N8BT000
1.8	±0.2nH	500	10	500	8.0	10.6	0.3	0.19	250	MHQ0402P1N8CT000
1.8	±0.3nH	500	10	500	8.0	10.6	0.3	0.19	250	MHQ0402P1N8ST000
1.9	±0.1nH	500	10	500	8.0	10.6	0.4	0.25	250	MHQ0402P1N9BT000
1.9	±0.2nH	500	10	500	8.0	10.6	0.4	0.25	250	MHQ0402P1N9CT000
1.9	±0.3nH	500	10	500	8.0	10.6	0.4	0.25	250	MHQ0402P1N9ST000
2.0	±0.1nH	500	10	500	8.0	10.5	0.4	0.29	250	MHQ0402P2N0BT000
2.0	±0.2nH	500	10	500	8.0	10.5	0.4	0.29	250	MHQ0402P2N0CT000
2.0	±0.3nH	500	10	500	8.0	10.5	0.4	0.29	250	MHQ0402P2N0ST000
2.1	±0.1nH	500	10	500	6.0	8.9	0.4	0.20	250	MHQ0402P2N1BT000
2.1	±0.2nH	500	10	500	6.0	8.9	0.4	0.20	250	MHQ0402P2N1CT000
2.1	±0.3nH	500	10	500	6.0	8.9	0.4	0.20	250	MHQ0402P2N1ST000
2.2	±0.1nH	500	10	500	6.0	8.8	0.4	0.20	250	MHQ0402P2N2BT000
2.2	±0.2nH	500	10	500	6.0	8.8	0.4	0.20	250	MHQ0402P2N2CT000
2.2	±0.3nH	500	10	500	6.0	8.8	0.4	0.20	250	MHQ0402P2N2ST000
2.3	±0.1nH	500	10	500	6.0	8.4	0.4	0.17	200	MHQ0402P2N3BT000
2.3	±0.2nH	500	10	500	6.0	8.4	0.4	0.17	200	MHQ0402P2N3CT000
2.3	±0.3nH	500	10	500	6.0	8.4	0.4	0.17	200	MHQ0402P2N3ST000
2.4	±0.1nH	500	10	500	6.0	8.6	0.4	0.20	200	MHQ0402P2N4BT000
2.4	±0.2nH	500	10	500	6.0	8.6	0.4	0.20	200	MHQ0402P2N4CT000
2.4	±0.3nH	500	10	500	6.0	8.6	0.4	0.20	200	MHQ0402P2N4ST000
2.5	±0.1nH	500	10	500	6.0	8.3	0.4	0.20	200	MHQ0402P2N5BT000
2.5	±0.2nH	500	10	500	6.0	8.3	0.4	0.20	200	MHQ0402P2N5CT000
2.5	±0.3nH	500	10	500	6.0	8.3	0.4	0.20	200	MHQ0402P2N5ST000
2.6	±0.1nH	500	10	500	6.0	8.6	0.4	0.21	200	MHQ0402P2N6BT000
2.6	±0.2nH	500	10	500	6.0	8.6	0.4	0.21	200	MHQ0402P2N6CT000
2.6	±0.3nH	500	10	500	6.0	8.6	0.4	0.21	200	MHQ0402P2N6ST000
2.7	±0.1nH	500	10	500	6.0	8.0	0.4	0.21	200	MHQ0402P2N7BT000
2.7	±0.2nH	500	10	500	6.0	8.0	0.4	0.21	200	MHQ0402P2N7CT000
2.7	±0.3nH	500	10	500	6.0	8.0	0.4	0.21	200	MHQ0402P2N7ST000
2.8	±0.1nH	500	10	500	6.0	8.0	0.4	0.19	200	MHQ0402P2N8BT000
2.8	±0.2nH	500	10	500	6.0	8.0	0.4	0.19	200	MHQ0402P2N8CT000
2.8	±0.3nH	500	10	500	6.0	8.0	0.4	0.19	200	MHQ0402P2N8ST000
2.9	±0.1nH	500	10	500	6.0	8.3	0.4	0.22	200	MHQ0402P2N9BT000

· Short bar residual inductance =0.11nH

○ Measurement equipment

Measurement item	Product No.	Manufacturer
L, Q	4991A+16196D	Agilent Technologies
Self-resonant frequency	8720C	Agilent Technologies
DC resistance	4338A	Yokogawa

* Equivalent measurement equipment may be used.

⚠ Please be sure to request delivery specifications that provide further details on the features and specifications of the products for proper and safe use.
Please note that the contents may change without any prior notice due to reasons such as upgrading.

MHQ-P_{series} **MHQ0402P Type**

■ ELECTRICAL CHARACTERISTICS

□ CHARACTERISTICS SPECIFICATION TABLE

L (nH)	Tolerance	L measuring frequency (MHz)	Q min.	Q measuring frequency (MHz)	Self-resonant frequency (GHz)		DC resistance (Ω)		Rated current (mA) max.	Part No.
					min.	typ.	max.	typ.		
2.9	± 0.2 nH	500	10	500	6.0	8.3	0.4	0.22	200	MHQ0402P2N9CT000
2.9	± 0.3 nH	500	10	500	6.0	8.3	0.4	0.22	200	MHQ0402P2N9ST000
3.0	± 0.1 nH	500	10	500	6.0	8.2	0.5	0.26	200	MHQ0402P3N0BT000
3.0	± 0.2 nH	500	10	500	6.0	8.2	0.5	0.26	200	MHQ0402P3N0CT000
3.0	± 0.3 nH	500	10	500	6.0	8.2	0.5	0.26	200	MHQ0402P3N0ST000
3.1	± 0.1 nH	500	10	500	5.0	7.9	0.5	0.26	200	MHQ0402P3N1BT000
3.1	± 0.2 nH	500	10	500	5.0	7.9	0.5	0.26	200	MHQ0402P3N1CT000
3.1	± 0.3 nH	500	10	500	5.0	7.9	0.5	0.26	200	MHQ0402P3N1ST000
3.2	± 0.1 nH	500	10	500	5.0	7.0	0.5	0.24	200	MHQ0402P3N2BT000
3.2	± 0.2 nH	500	10	500	5.0	7.0	0.5	0.24	200	MHQ0402P3N2CT000
3.2	± 0.3 nH	500	10	500	5.0	7.0	0.5	0.24	200	MHQ0402P3N2ST000
3.3	± 0.1 nH	500	10	500	5.0	7.1	0.5	0.26	200	MHQ0402P3N3BT000
3.3	± 0.2 nH	500	10	500	5.0	7.1	0.5	0.26	200	MHQ0402P3N3CT000
3.3	± 0.3 nH	500	10	500	5.0	7.1	0.5	0.26	200	MHQ0402P3N3ST000
3.4	± 0.1 nH	500	10	500	5.0	7.2	0.5	0.25	200	MHQ0402P3N4BT000
3.4	± 0.2 nH	500	10	500	5.0	7.2	0.5	0.25	200	MHQ0402P3N4CT000
3.4	± 0.3 nH	500	10	500	5.0	7.2	0.5	0.25	200	MHQ0402P3N4ST000
3.5	± 0.1 nH	500	10	500	5.0	7.2	0.5	0.26	200	MHQ0402P3N5BT000
3.5	± 0.2 nH	500	10	500	5.0	7.2	0.5	0.26	200	MHQ0402P3N5CT000
3.5	± 0.3 nH	500	10	500	5.0	7.2	0.5	0.26	200	MHQ0402P3N5ST000
3.6	± 0.1 nH	500	10	500	5.0	7.2	0.5	0.26	200	MHQ0402P3N6BT000
3.6	± 0.2 nH	500	10	500	5.0	7.2	0.5	0.26	200	MHQ0402P3N6CT000
3.6	± 0.3 nH	500	10	500	5.0	7.2	0.5	0.26	200	MHQ0402P3N6ST000
3.7	± 0.1 nH	500	10	500	5.0	6.7	0.5	0.25	200	MHQ0402P3N7BT000
3.7	± 0.2 nH	500	10	500	5.0	6.7	0.5	0.25	200	MHQ0402P3N7CT000
3.7	± 0.3 nH	500	10	500	5.0	6.7	0.5	0.25	200	MHQ0402P3N7ST000
3.8	± 0.1 nH	500	10	500	5.0	6.6	0.5	0.25	200	MHQ0402P3N8BT000
3.8	± 0.2 nH	500	10	500	5.0	6.6	0.5	0.25	200	MHQ0402P3N8CT000
3.8	± 0.3 nH	500	10	500	5.0	6.6	0.5	0.25	200	MHQ0402P3N8ST000
3.9	± 0.1 nH	500	10	500	5.0	6.8	0.5	0.29	200	MHQ0402P3N9BT000
3.9	± 0.2 nH	500	10	500	5.0	6.8	0.5	0.29	200	MHQ0402P3N9CT000
3.9	± 0.3 nH	500	10	500	5.0	6.8	0.5	0.29	200	MHQ0402P3N9ST000
4.0	± 0.1 nH	500	10	500	5.0	6.7	0.5	0.26	200	MHQ0402P4N0BT000
4.0	± 0.2 nH	500	10	500	5.0	6.7	0.5	0.26	200	MHQ0402P4N0CT000
4.0	± 0.3 nH	500	10	500	5.0	6.7	0.5	0.26	200	MHQ0402P4N0ST000
4.1	± 0.1 nH	500	10	500	5.0	6.6	0.5	0.27	200	MHQ0402P4N1BT000
4.1	± 0.2 nH	500	10	500	5.0	6.6	0.5	0.27	200	MHQ0402P4N1CT000
4.1	± 0.3 nH	500	10	500	5.0	6.6	0.5	0.27	200	MHQ0402P4N1ST000
4.2	± 0.1 nH	500	10	500	5.0	6.7	0.5	0.29	200	MHQ0402P4N2BT000
4.2	± 0.2 nH	500	10	500	5.0	6.7	0.5	0.29	200	MHQ0402P4N2CT000

· Short bar residual inductance =0.11nH

○ Measurement equipment

Measurement item	Product No.	Manufacturer
L, Q	4991A+16196D	Agilent Technologies
Self-resonant frequency	8720C	Agilent Technologies
DC resistance	4338A	Yokogawa

* Equivalent measurement equipment may be used.

MHQ-P_{series} MHQ0402P Type

ELECTRICAL CHARACTERISTICS

CHARACTERISTICS SPECIFICATION TABLE

L (nH)	Tolerance	L measuring frequency (MHz)	Q min.	Q measuring frequency (MHz)	Self-resonant frequency (GHz)		DC resistance (Ω)		Rated current (mA) max.	Part No.
					min.	typ.	max.	typ.		
4.2	± 0.3 nH	500	10	500	5.0	6.7	0.5	0.29	200	MHQ0402P4N2ST000
4.3	$\pm 3\%$	500	10	500	5.0	7.1	0.7	0.49	200	MHQ0402P4N3HT000
4.3	$\pm 5\%$	500	10	500	5.0	7.1	0.7	0.49	200	MHQ0402P4N3JT000
4.4	$\pm 3\%$	500	10	500	5.0	6.9	0.7	0.50	200	MHQ0402P4N4HT000
4.4	$\pm 5\%$	500	10	500	5.0	6.9	0.7	0.50	200	MHQ0402P4N4JT000
4.5	$\pm 3\%$	500	10	500	5.0	6.7	0.7	0.51	200	MHQ0402P4N5HT000
4.5	$\pm 5\%$	500	10	500	5.0	6.7	0.7	0.51	200	MHQ0402P4N5JT000
4.6	$\pm 3\%$	500	10	500	5.0	6.8	0.7	0.50	200	MHQ0402P4N6HT000
4.6	$\pm 5\%$	500	10	500	5.0	6.8	0.7	0.50	200	MHQ0402P4N6JT000
4.7	$\pm 3\%$	500	10	500	5.0	6.6	0.7	0.49	200	MHQ0402P4N7HT000
4.7	$\pm 5\%$	500	10	500	5.0	6.6	0.7	0.49	200	MHQ0402P4N7JT000
4.8	$\pm 3\%$	500	10	500	5.0	6.5	0.7	0.52	200	MHQ0402P4N8HT000
4.8	$\pm 5\%$	500	10	500	5.0	6.5	0.7	0.52	200	MHQ0402P4N8JT000
4.9	$\pm 3\%$	500	10	500	5.0	6.5	0.8	0.53	200	MHQ0402P4N9HT000
4.9	$\pm 5\%$	500	10	500	5.0	6.5	0.8	0.53	200	MHQ0402P4N9JT000
5.0	$\pm 3\%$	500	10	500	4.0	6.4	0.8	0.55	200	MHQ0402P5N0HT000
5.0	$\pm 5\%$	500	10	500	4.0	6.4	0.8	0.55	200	MHQ0402P5N0JT000
5.1	$\pm 3\%$	500	10	500	4.0	6.2	1.0	0.63	200	MHQ0402P5N1HT000
5.1	$\pm 5\%$	500	10	500	4.0	6.2	1.0	0.63	200	MHQ0402P5N1JT000
5.6	$\pm 3\%$	500	10	500	4.0	6.0	1.0	0.58	200	MHQ0402P5N6HT000
5.6	$\pm 5\%$	500	10	500	4.0	6.0	1.0	0.58	200	MHQ0402P5N6JT000
6.2	$\pm 3\%$	500	10	500	4.0	5.6	1.0	0.60	200	MHQ0402P6N2HT000
6.2	$\pm 5\%$	500	10	500	4.0	5.6	1.0	0.60	200	MHQ0402P6N2JT000
6.8	$\pm 3\%$	500	10	500	4.0	5.2	1.0	0.61	200	MHQ0402P6N8HT000
6.8	$\pm 5\%$	500	10	500	4.0	5.2	1.0	0.61	200	MHQ0402P6N8JT000
7.5	$\pm 3\%$	500	10	500	3.0	4.4	1.2	0.74	200	MHQ0402P7N5HT000
7.5	$\pm 5\%$	500	10	500	3.0	4.4	1.2	0.74	200	MHQ0402P7N5JT000
8.2	$\pm 3\%$	500	10	500	3.0	4.7	1.2	0.69	180	MHQ0402P8N2HT000
8.2	$\pm 5\%$	500	10	500	3.0	4.7	1.2	0.69	180	MHQ0402P8N2JT000
9.1	$\pm 3\%$	500	10	500	3.0	4.4	1.5	0.78	180	MHQ0402P9N1HT000
9.1	$\pm 5\%$	500	10	500	3.0	4.4	1.5	0.78	180	MHQ0402P9N1JT000
10.0	$\pm 3\%$	500	10	500	3.0	4.2	1.5	0.77	160	MHQ0402P10NHT000
10.0	$\pm 5\%$	500	10	500	3.0	4.2	1.5	0.77	160	MHQ0402P10NJT000
11.0	$\pm 3\%$	500	10	500	3.0	3.8	2.0	0.78	160	MHQ0402P11NHT000
11.0	$\pm 5\%$	500	10	500	3.0	3.8	2.0	0.78	160	MHQ0402P11NJT000
12.0	$\pm 3\%$	500	10	500	3.0	4.2	2.0	0.78	160	MHQ0402P12NHT000
12.0	$\pm 5\%$	500	10	500	3.0	4.2	2.0	0.78	160	MHQ0402P12NJT000
13.0	$\pm 3\%$	500	10	500	3.0	4.1	2.0	0.88	160	MHQ0402P13NHT000
13.0	$\pm 5\%$	500	10	500	3.0	4.1	2.0	0.88	160	MHQ0402P13NJT000
15.0	$\pm 3\%$	500	10	500	2.0	3.4	2.0	0.88	150	MHQ0402P15NHT000

· Short bar residual inductance =0.11nH

○ Measurement equipment

Measurement item	Product No.	Manufacturer
L, Q	4991A+16196D	Agilent Technologies
Self-resonant frequency	8720C	Agilent Technologies
DC resistance	4338A	Yokogawa

* Equivalent measurement equipment may be used.

MHQ-P_{series} MHQ0402P Type

■ ELECTRICAL CHARACTERISTICS

□ CHARACTERISTICS SPECIFICATION TABLE

L (nH)	Tolerance	L measuring frequency (MHz)	Q min.	Q measuring frequency (MHz)	Self-resonant frequency (GHz)		DC resistance (Ω)		Rated current (mA) max.	Part No.
					min.	typ.	max.	typ.		
15.0	±5%	500	10	500	2.0	3.4	2.0	0.88	150	MHQ0402P15NJT000
16.0	±3%	500	10	500	2.0	3.4	2.5	1.30	140	MHQ0402P16NHT000
16.0	±5%	500	10	500	2.0	3.4	2.5	1.30	140	MHQ0402P16NJT000
18.0	±3%	500	10	500	2.0	3.0	2.5	1.45	140	MHQ0402P18NHT000
18.0	±5%	500	10	500	2.0	3.0	2.5	1.45	140	MHQ0402P18NJT000
20.0	±3%	500	10	500	2.0	2.9	2.5	1.81	140	MHQ0402P20NHT000
20.0	±5%	500	10	500	2.0	2.9	2.5	1.81	140	MHQ0402P20NJT000
22.0	±3%	500	10	500	2.0	2.9	3.0	1.89	140	MHQ0402P22NHT000
22.0	±5%	500	10	500	2.0	2.9	3.0	1.89	140	MHQ0402P22NJT000
24.0	±3%	500	10	500	2.0	2.9	3.0	1.96	130	MHQ0402P24NHT000
24.0	±5%	500	10	500	2.0	2.9	3.0	1.96	130	MHQ0402P24NJT000
27.0	±3%	500	10	500	1.5	2.6	3.0	2.03	130	MHQ0402P27NHT000
27.0	±5%	500	10	500	1.5	2.6	3.0	2.03	130	MHQ0402P27NJT000
30.0	±3%	500	10	500	1.5	2.5	3.5	2.23	130	MHQ0402P30NHT000
30.0	±5%	500	10	500	1.5	2.5	3.5	2.23	130	MHQ0402P30NJT000
33.0	±3%	300	7	300	1.5	2.2	3.5	2.48	130	MHQ0402P33NHT000
33.0	±5%	300	7	300	1.5	2.2	3.5	2.48	130	MHQ0402P33NJT000

· Short bar residual inductance =0.11nH

○ Measurement equipment

Measurement item	Product No.	Manufacturer
L, Q	4991A+16196D	Agilent Technologies
Self-resonant frequency	8720C	Agilent Technologies
DC resistance	4338A	Yokogawa

* Equivalent measurement equipment may be used.

MHQ-P_{series} **MHQ0402P Type**

■ ELECTRICAL CHARACTERISTICS

□ L, Q FREQUENCY CHARACTERISTICS TABLE

L(nH)typ.					Q typ.					Part No.
500MHz	800MHz	1.8GHz	2.0GHz	2.4GHz	500MHz	800MHz	1.8GHz	2.0GHz	2.4GHz	
0.2	0.2	0.2	0.2	0.2	14.4	20	30	32	35	MHQ0402P0N2BT000
0.2	0.2	0.2	0.2	0.2	14.4	20	30	32	35	MHQ0402P0N2CT000
0.3	0.3	0.3	0.3	0.3	14.1	19	30	33	36	MHQ0402P0N3BT000
0.3	0.3	0.3	0.3	0.3	14.1	19	30	33	36	MHQ0402P0N3CT000
0.4	0.4	0.4	0.4	0.4	9.6	13	22	23	26	MHQ0402P0N4BT000
0.4	0.4	0.4	0.4	0.4	9.6	13	22	23	26	MHQ0402P0N4CT000
0.4	0.4	0.4	0.4	0.4	9.6	13	22	23	26	MHQ0402P0N4ST000
0.5	0.5	0.5	0.5	0.5	12	16	25	27	30	MHQ0402P0N5BT000
0.5	0.5	0.5	0.5	0.5	12	16	25	27	30	MHQ0402P0N5CT000
0.5	0.5	0.5	0.5	0.5	12	16	25	27	30	MHQ0402P0N5ST000
0.6	0.6	0.6	0.6	0.6	13	17	27	29	33	MHQ0402P0N6BT000
0.6	0.6	0.6	0.6	0.6	13	17	27	29	33	MHQ0402P0N6CT000
0.6	0.6	0.6	0.6	0.6	13	17	27	29	33	MHQ0402P0N6ST000
0.7	0.7	0.7	0.7	0.7	12	16	25	27	30	MHQ0402P0N7BT000
0.7	0.7	0.7	0.7	0.7	12	16	25	27	30	MHQ0402P0N7CT000
0.7	0.7	0.7	0.7	0.7	12	16	25	27	30	MHQ0402P0N7ST000
0.8	0.8	0.8	0.8	0.8	12	17	27	28	32	MHQ0402P0N8BT000
0.8	0.8	0.8	0.8	0.8	12	17	27	28	32	MHQ0402P0N8CT000
0.8	0.8	0.8	0.8	0.8	12	17	27	28	32	MHQ0402P0N8ST000
0.9	0.9	0.9	0.9	0.9	12	15	24	26	29	MHQ0402P0N9BT000
0.9	0.9	0.9	0.9	0.9	12	15	24	26	29	MHQ0402P0N9CT000
0.9	0.9	0.9	0.9	0.9	12	15	24	26	29	MHQ0402P0N9ST000
1.0	1.0	1.0	1.0	1.0	13	17	27	29	32	MHQ0402P1N0BT000
1.0	1.0	1.0	1.0	1.0	13	17	27	29	32	MHQ0402P1N0CT000
1.0	1.0	1.0	1.0	1.0	13	17	27	29	32	MHQ0402P1N0ST000
1.1	1.1	1.1	1.1	1.1	13	16	25	27	30	MHQ0402P1N1BT000
1.1	1.1	1.1	1.1	1.1	13	16	25	27	30	MHQ0402P1N1CT000
1.1	1.1	1.1	1.1	1.1	13	16	25	27	30	MHQ0402P1N1ST000
1.2	1.2	1.2	1.2	1.2	15	19	30	32	36	MHQ0402P1N2BT000
1.2	1.2	1.2	1.2	1.2	15	19	30	32	36	MHQ0402P1N2CT000
1.2	1.2	1.2	1.2	1.2	15	19	30	32	36	MHQ0402P1N2ST000
1.3	1.3	1.3	1.3	1.3	15	19	29	32	35	MHQ0402P1N3BT000
1.3	1.3	1.3	1.3	1.3	15	19	29	32	35	MHQ0402P1N3CT000
1.3	1.3	1.3	1.3	1.3	15	19	29	32	35	MHQ0402P1N3ST000
1.4	1.4	1.4	1.4	1.4	14	18	28	30	34	MHQ0402P1N4BT000
1.4	1.4	1.4	1.4	1.4	14	18	28	30	34	MHQ0402P1N4CT000
1.4	1.4	1.4	1.4	1.4	14	18	28	30	34	MHQ0402P1N4ST000
1.5	1.5	1.5	1.5	1.5	14	18	29	31	34	MHQ0402P1N5BT000
1.5	1.5	1.5	1.5	1.5	14	18	29	31	34	MHQ0402P1N5CT000
1.5	1.5	1.5	1.5	1.5	14	18	29	31	34	MHQ0402P1N5ST000
1.6	1.6	1.6	1.6	1.6	14	18	29	32	36	MHQ0402P1N6BT000
1.6	1.6	1.6	1.6	1.6	14	18	29	32	36	MHQ0402P1N6CT000
1.6	1.6	1.6	1.6	1.6	14	18	29	32	36	MHQ0402P1N6ST000
1.7	1.7	1.7	1.7	1.7	14	18	29	31	34	MHQ0402P1N7BT000

○ Measurement equipment

Measurement item	Product No.	Manufacturer
L, Q	4991A+16196D	Agilent Technologies
Self-resonant frequency	8720C	Agilent Technologies
DC resistance	4338A	Yokogawa

* Equivalent measurement equipment may be used.

⚠ Please be sure to request delivery specifications that provide further details on the features and specifications of the products for proper and safe use.
Please note that the contents may change without any prior notice due to reasons such as upgrading.

MHQ-P_{series} **MHQ0402P Type**

■ ELECTRICAL CHARACTERISTICS

□ L, Q FREQUENCY CHARACTERISTICS TABLE

L(nH)typ.					Q typ.					Part No.
500MHz	800MHz	1.8GHz	2.0GHz	2.4GHz	500MHz	800MHz	1.8GHz	2.0GHz	2.4GHz	
1.7	1.7	1.7	1.7	1.7	14	18	29	31	34	MHQ0402P1N7CT000
1.7	1.7	1.7	1.7	1.7	14	18	29	31	34	MHQ0402P1N7ST000
1.8	1.8	1.8	1.8	1.8	14	18	27	30	33	MHQ0402P1N8BT000
1.8	1.8	1.8	1.8	1.8	14	18	27	30	33	MHQ0402P1N8CT000
1.8	1.8	1.8	1.8	1.8	14	18	27	30	33	MHQ0402P1N8ST000
1.9	1.9	1.9	1.9	1.9	12	16	26	28	31	MHQ0402P1N9BT000
1.9	1.9	1.9	1.9	1.9	12	16	26	28	31	MHQ0402P1N9CT000
1.9	1.9	1.9	1.9	1.9	12	16	26	28	31	MHQ0402P1N9ST000
2.0	2.0	2.0	2.0	2.0	12	16	26	28	31	MHQ0402P2N0BT000
2.0	2.0	2.0	2.0	2.0	12	16	26	28	31	MHQ0402P2N0CT000
2.0	2.0	2.0	2.0	2.0	12	16	26	28	31	MHQ0402P2N0ST000
2.1	2.1	2.1	2.1	2.1	12	16	26	28	31	MHQ0402P2N1BT000
2.1	2.1	2.1	2.1	2.1	12	16	26	28	31	MHQ0402P2N1CT000
2.1	2.1	2.1	2.1	2.1	12	16	26	28	31	MHQ0402P2N1ST000
2.2	2.2	2.2	2.2	2.2	13	17	27	30	33	MHQ0402P2N2BT000
2.2	2.2	2.2	2.2	2.2	13	17	27	30	33	MHQ0402P2N2CT000
2.2	2.2	2.2	2.2	2.2	13	17	27	30	33	MHQ0402P2N2ST000
2.3	2.3	2.3	2.3	2.3	14	18	29	31	34	MHQ0402P2N3BT000
2.3	2.3	2.3	2.3	2.3	14	18	29	31	34	MHQ0402P2N3CT000
2.3	2.3	2.3	2.3	2.3	14	18	29	31	34	MHQ0402P2N3ST000
2.4	2.4	2.4	2.4	2.4	14	18	29	31	33	MHQ0402P2N4BT000
2.4	2.4	2.4	2.4	2.4	14	18	29	31	33	MHQ0402P2N4CT000
2.4	2.4	2.4	2.4	2.4	14	18	29	31	33	MHQ0402P2N4ST000
2.5	2.5	2.5	2.5	2.5	14	18	28	31	33	MHQ0402P2N5BT000
2.5	2.5	2.5	2.5	2.5	14	18	28	31	33	MHQ0402P2N5CT000
2.5	2.5	2.5	2.5	2.5	14	18	28	31	33	MHQ0402P2N5ST000
2.6	2.6	2.6	2.6	2.6	14	17	28	30	33	MHQ0402P2N6BT000
2.6	2.6	2.6	2.6	2.6	14	17	28	30	33	MHQ0402P2N6CT000
2.6	2.6	2.6	2.6	2.6	14	17	28	30	33	MHQ0402P2N6ST000
2.7	2.7	2.7	2.7	2.8	13	17	26	28	31	MHQ0402P2N7BT000
2.7	2.7	2.7	2.7	2.8	13	17	26	28	31	MHQ0402P2N7CT000
2.7	2.7	2.7	2.7	2.8	13	17	26	28	31	MHQ0402P2N7ST000
2.8	2.8	2.8	2.8	2.9	14	18	28	30	32	MHQ0402P2N8BT000
2.8	2.8	2.8	2.8	2.9	14	18	28	30	32	MHQ0402P2N8CT000
2.8	2.8	2.8	2.8	2.9	14	18	28	30	32	MHQ0402P2N8ST000
2.9	2.9	2.9	2.9	2.9	13	17	27	29	31	MHQ0402P2N9BT000
2.9	2.9	2.9	2.9	2.9	13	17	27	29	31	MHQ0402P2N9CT000
2.9	2.9	2.9	2.9	2.9	13	17	27	29	31	MHQ0402P2N9ST000
3.0	3.0	3.0	3.0	3.0	13	17	27	29	31	MHQ0402P3N0BT000
3.0	3.0	3.0	3.0	3.0	13	17	27	29	31	MHQ0402P3N0CT000
3.0	3.0	3.0	3.0	3.0	13	17	27	29	31	MHQ0402P3N0ST000
3.1	3.1	3.1	3.1	3.1	13	17	27	29	31	MHQ0402P3N1BT000
3.1	3.1	3.1	3.1	3.1	13	17	27	29	31	MHQ0402P3N1CT000
3.1	3.1	3.1	3.1	3.1	13	17	27	29	31	MHQ0402P3N1ST000

○ Measurement equipment

Measurement item	Product No.	Manufacturer
L, Q	4991A+16196D	Agilent Technologies
Self-resonant frequency	8720C	Agilent Technologies
DC resistance	4338A	Yokogawa

* Equivalent measurement equipment may be used.

⚠ Please be sure to request delivery specifications that provide further details on the features and specifications of the products for proper and safe use.
Please note that the contents may change without any prior notice due to reasons such as upgrading.

MHQ-P_{series} **MHQ0402P Type**

■ ELECTRICAL CHARACTERISTICS

□ L, Q FREQUENCY CHARACTERISTICS TABLE

L(nH)typ.					Q typ.					Part No.
500MHz	800MHz	1.8GHz	2.0GHz	2.4GHz	500MHz	800MHz	1.8GHz	2.0GHz	2.4GHz	
3.2	3.2	3.2	3.3	3.3	14	18	28	30	32	MHQ0402P3N2BT000
3.2	3.2	3.2	3.3	3.3	14	18	28	30	32	MHQ0402P3N2CT000
3.2	3.2	3.2	3.3	3.3	14	18	28	30	32	MHQ0402P3N2ST000
3.3	3.3	3.3	3.3	3.4	13	17	27	29	32	MHQ0402P3N3BT000
3.3	3.3	3.3	3.3	3.4	13	17	27	29	32	MHQ0402P3N3CT000
3.3	3.3	3.3	3.3	3.4	13	17	27	29	32	MHQ0402P3N3ST000
3.4	3.4	3.4	3.5	3.6	13	17	26	28	30	MHQ0402P3N4BT000
3.4	3.4	3.4	3.5	3.6	13	17	26	28	30	MHQ0402P3N4CT000
3.4	3.4	3.4	3.5	3.6	13	17	26	28	30	MHQ0402P3N4ST000
3.5	3.5	3.5	3.6	3.7	15	18	28	30	32	MHQ0402P3N5BT000
3.5	3.5	3.5	3.6	3.7	15	18	28	30	32	MHQ0402P3N5CT000
3.5	3.5	3.5	3.6	3.7	15	18	28	30	32	MHQ0402P3N5ST000
3.6	3.6	3.6	3.7	3.8	14	17	27	29	31	MHQ0402P3N6BT000
3.6	3.6	3.6	3.7	3.8	14	17	27	29	31	MHQ0402P3N6CT000
3.6	3.6	3.6	3.7	3.8	14	17	27	29	31	MHQ0402P3N6ST000
3.7	3.7	3.8	3.8	3.9	14	18	27	29	31	MHQ0402P3N7BT000
3.7	3.7	3.8	3.8	3.9	14	18	27	29	31	MHQ0402P3N7CT000
3.7	3.7	3.8	3.8	3.9	14	18	27	29	31	MHQ0402P3N7ST000
3.8	3.8	3.9	3.9	4.0	14	18	28	30	32	MHQ0402P3N8BT000
3.8	3.8	3.9	3.9	4.0	14	18	28	30	32	MHQ0402P3N8CT000
3.8	3.8	3.9	3.9	4.0	14	18	28	30	32	MHQ0402P3N8ST000
3.9	3.9	4.0	4.1	4.3	14	18	27	29	31	MHQ0402P3N9BT000
3.9	3.9	4.0	4.1	4.3	14	18	27	29	31	MHQ0402P3N9CT000
3.9	3.9	4.0	4.1	4.3	14	18	27	29	31	MHQ0402P3N9ST000
4.0	4.0	4.1	4.1	4.2	13	16	25	27	29	MHQ0402P4N0BT000
4.0	4.0	4.1	4.1	4.2	13	16	25	27	29	MHQ0402P4N0CT000
4.0	4.0	4.1	4.1	4.2	13	16	25	27	29	MHQ0402P4N0ST000
4.1	4.1	4.2	4.2	4.3	13	16	25	27	29	MHQ0402P4N1BT000
4.1	4.1	4.2	4.2	4.3	13	16	25	27	29	MHQ0402P4N1CT000
4.1	4.1	4.2	4.2	4.3	13	16	25	27	29	MHQ0402P4N1ST000
4.2	4.2	4.2	4.3	4.4	14	18	28	30	32	MHQ0402P4N2BT000
4.2	4.2	4.2	4.3	4.4	14	18	28	30	32	MHQ0402P4N2CT000
4.2	4.2	4.2	4.3	4.4	14	18	28	30	32	MHQ0402P4N2ST000
4.3	4.3	4.3	4.4	4.5	14	18	28	30	32	MHQ0402P4N3HT000
4.3	4.3	4.3	4.4	4.5	14	18	28	30	32	MHQ0402P4N3JT000
4.4	4.4	4.4	4.5	4.6	14	18	28	30	33	MHQ0402P4N4HT000
4.4	4.4	4.4	4.5	4.6	14	18	28	30	33	MHQ0402P4N4JT000
4.5	4.5	4.5	4.6	4.7	14	18	28	30	32	MHQ0402P4N5HT000
4.5	4.5	4.5	4.6	4.7	14	18	28	30	32	MHQ0402P4N5JT000
4.6	4.6	4.6	4.7	4.8	14	18	28	30	33	MHQ0402P4N6HT000
4.6	4.6	4.6	4.7	4.8	14	18	28	30	33	MHQ0402P4N6JT000
4.7	4.7	4.7	4.8	4.9	13	17	27	29	31	MHQ0402P4N7HT000
4.7	4.7	4.7	4.8	4.9	13	17	27	29	31	MHQ0402P4N7JT000

○ Measurement equipment

Measurement item	Product No.	Manufacturer
L, Q	4991A+16196D	Agilent Technologies
Self-resonant frequency	8720C	Agilent Technologies
DC resistance	4338A	Yokogawa

* Equivalent measurement equipment may be used.

⚠ Please be sure to request delivery specifications that provide further details on the features and specifications of the products for proper and safe use.
Please note that the contents may change without any prior notice due to reasons such as upgrading.

MHQ-P_{series} MHQ0402P Type

ELECTRICAL CHARACTERISTICS

L, Q FREQUENCY CHARACTERISTICS TABLE

L(nH)typ.					Q typ.					Part No.
500MHz	800MHz	1.8GHz	2.0GHz	2.4GHz	500MHz	800MHz	1.8GHz	2.0GHz	2.4GHz	
4.8	4.8	4.9	4.9	5.1	14	18	28	30	32	MHQ0402P4N8HT000
4.8	4.8	4.9	4.9	5.1	14	18	28	30	32	MHQ0402P4N8JT000
4.9	4.9	5.0	5.0	5.1	14	18	27	29	32	MHQ0402P4N9HT000
4.9	4.9	5.0	5.0	5.1	14	18	27	29	32	MHQ0402P4N9JT000
5.0	5.0	5.1	5.1	5.3	14	17	26	28	30	MHQ0402P5N0HT000
5.0	5.0	5.1	5.1	5.3	14	17	26	28	30	MHQ0402P5N0JT000
5.1	5.1	5.2	5.3	5.4	14	18	28	31	33	MHQ0402P5N1HT000
5.1	5.1	5.2	5.3	5.4	14	18	28	31	33	MHQ0402P5N1JT000
5.6	5.6	5.7	5.8	5.9	14	18	28	30	32	MHQ0402P5N6HT000
5.6	5.6	5.7	5.8	5.9	14	18	28	30	32	MHQ0402P5N6JT000
6.2	6.2	6.4	6.5	6.7	15	19	29	31	33	MHQ0402P6N2HT000
6.2	6.2	6.4	6.5	6.7	15	19	29	31	33	MHQ0402P6N2JT000
6.8	6.8	7.1	7.2	7.5	15	19	30	31	33	MHQ0402P6N8HT000
6.8	6.8	7.1	7.2	7.5	15	19	30	31	33	MHQ0402P6N8JT000
7.5	7.5	8.1	8.4	9.0	14	18	25	26	26	MHQ0402P7N5HT000
7.5	7.5	8.1	8.4	9.0	14	18	25	26	26	MHQ0402P7N5JT000
8.2	8.2	8.7	9.0	9.5	14	18	27	28	28	MHQ0402P8N2HT000
8.2	8.2	8.7	9.0	9.5	14	18	27	28	28	MHQ0402P8N2JT000
9.1	9.1	10.0	10.4	11.3	14	17	23	24	24	MHQ0402P9N1HT000
9.1	9.1	10.0	10.4	11.3	14	17	23	24	24	MHQ0402P9N1JT000
10.0	10.0	10.9	11.2	12.1	15	18	26	26	26	MHQ0402P10NHT000
10.0	10.0	10.9	11.2	12.1	15	18	26	26	26	MHQ0402P10NJT000
11.0	11.1	12.6	13.3	14.9	15	18	25	26	25	MHQ0402P11NHT000
11.0	11.1	12.6	13.3	14.9	15	18	25	26	25	MHQ0402P11NJT000
12.0	12.0	13.1	13.6	14.8	13	16	22	23	23	MHQ0402P12NHT000
12.0	12.0	13.1	13.6	14.8	13	16	22	23	23	MHQ0402P12NJT000
13.0	13.0	14.4	15.1	16.6	13	16	21	21	21	MHQ0402P13NHT000
13.0	13.0	14.4	15.1	16.6	13	16	21	21	21	MHQ0402P13NJT000
15.0	15.1	16.7	17.5	19.4	13	16	22	22	21	MHQ0402P15NHT000
15.0	15.1	16.7	17.5	19.4	13	16	22	22	21	MHQ0402P15NJT000
16.0	16.1	18.3	19.3	21.8	13	16	21	21	20	MHQ0402P16NHT000
16.0	16.1	18.3	19.3	21.8	13	16	21	21	20	MHQ0402P16NJT000
18.0	18.2	21.3	22.7	26.6	13	16	19	18	17	MHQ0402P18NHT000
18.0	18.2	21.3	22.7	26.6	13	16	19	18	17	MHQ0402P18NJT000
20.0	20.4	25.3	27.8	35.1	13	16	20	19	17	MHQ0402P20NHT000
20.0	20.4	25.3	27.8	35.1	13	16	20	19	17	MHQ0402P20NJT000
22.0	22.4	27.7	30.3	38.0	14	16	19	18	16	MHQ0402P22NHT000
22.0	22.4	27.7	30.3	38.0	14	16	19	18	16	MHQ0402P22NJT000
24.0	24.4	30.7	33.9	43.4	14	16	19	18	15	MHQ0402P24NHT000
24.0	24.4	30.7	33.9	43.4	14	16	19	18	15	MHQ0402P24NJT000
27.0	27.6	35.9	40.5	—	14	16	17	15	—	MHQ0402P27NHT000
27.0	27.6	35.9	40.5	—	14	16	17	15	—	MHQ0402P27NJT000
30.0	30.8	41.1	46.9	—	13	16	17	15	—	MHQ0402P30NHT000
30.0	30.8	41.1	46.9	—	13	16	17	15	—	MHQ0402P30NJT000
33.0	34.3	52.5	65.0	—	13	15	14	12	—	MHQ0402P33NHT000
33.0	34.3	52.5	65.0	—	13	15	14	12	—	MHQ0402P33NJT000

○ Measurement equipment

Measurement item	Product No.	Manufacturer
L, Q	4991A+16196D	Agilent Technologies
Self-resonant frequency	8720C	Agilent Technologies
DC resistance	4338A	Yokogawa

* Equivalent measurement equipment may be used.

⚠ Please be sure to request delivery specifications that provide further details on the features and specifications of the products for proper and safe use. Please note that the contents may change without any prior notice due to reasons such as upgrading.

MHQ-P_{series} MHQ0402PType

ELECTRICAL CHARACTERISTICS

L FREQUENCY CHARACTERISTICS GRAPH (EXAMPLE)

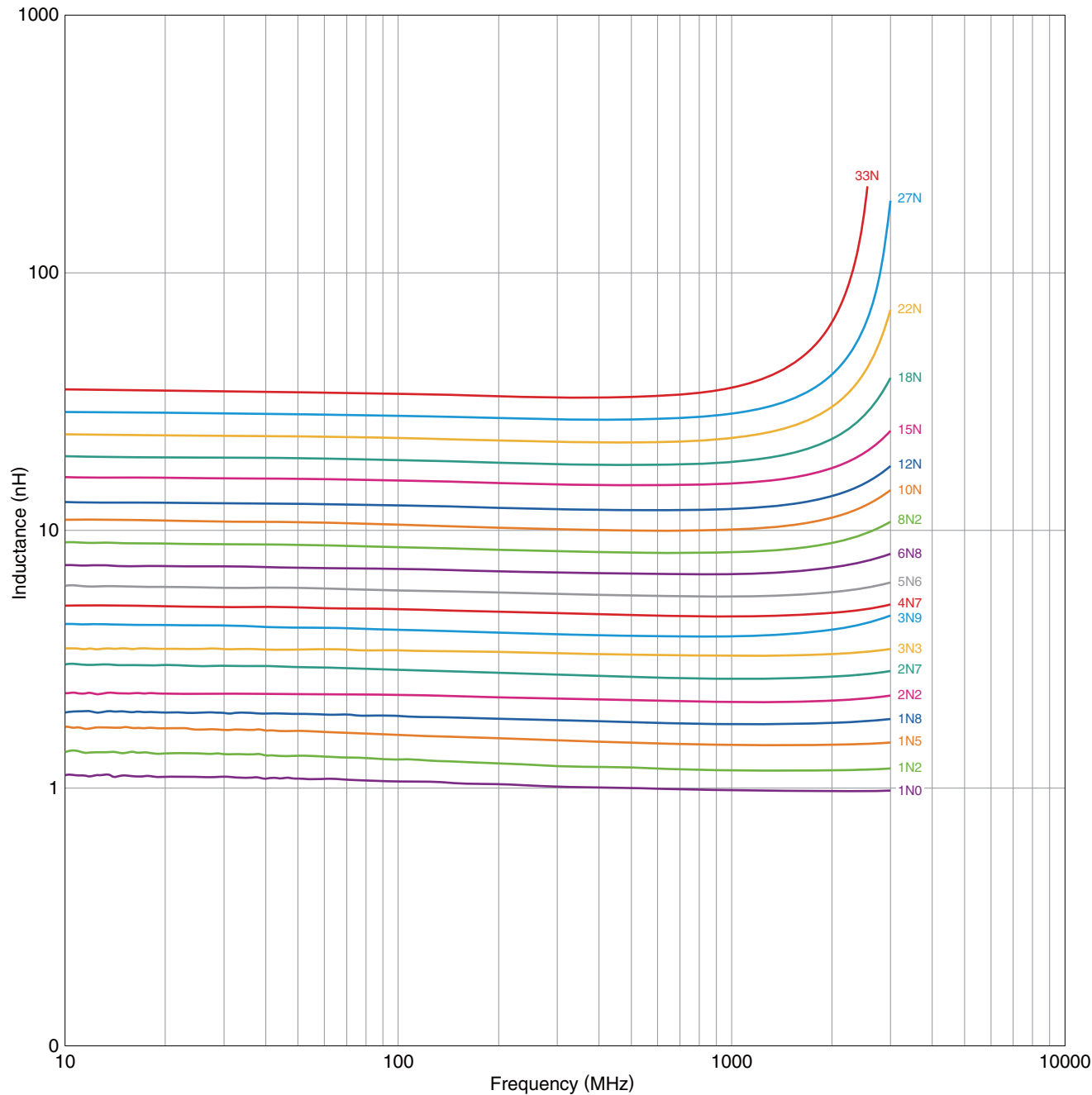

○ Measurement equipment

Product No.	Manufacturer
E4991A+16196D	Agilent Technologies

* Equivalent measurement equipment may be used.

 Please be sure to request delivery specifications that provide further details on the features and specifications of the products for proper and safe use. Please note that the contents may change without any prior notice due to reasons such as upgrading.

MHQ-P_{series} MHQ0402P Type

ELECTRICAL CHARACTERISTICS

Q FREQUENCY CHARACTERISTICS GRAPH (EXAMPLE)

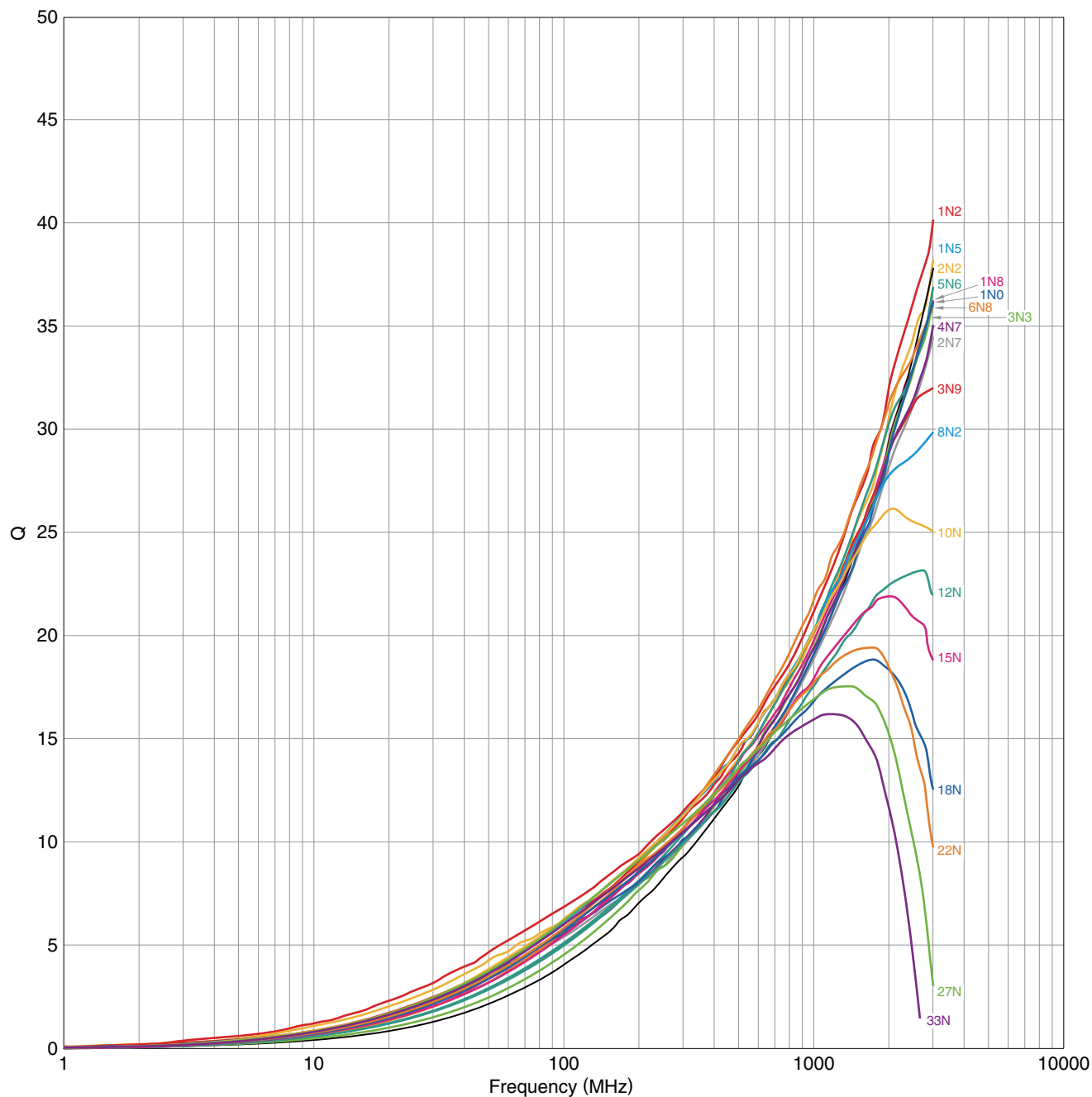

○ Measurement equipment

Product No.	Manufacturer
E4991A+16196D	Agilent Technologies

* Equivalent measurement equipment may be used.

 Please be sure to request delivery specifications that provide further details on the features and specifications of the products for proper and safe use. Please note that the contents may change without any prior notice due to reasons such as upgrading.

MHQ-P_{series}

MHQ0603P Type



■ SHAPE & DIMENSIONS

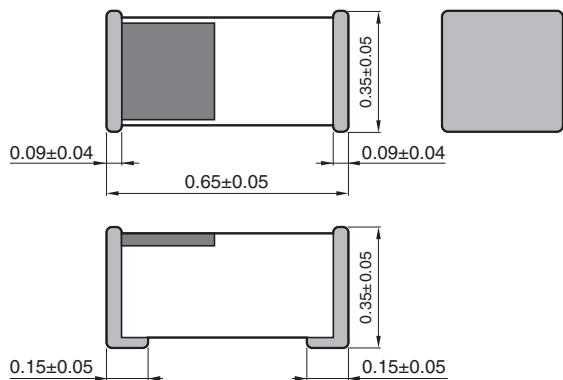

Dimensions in mm

■ RECOMMENDED LAND PATTERN

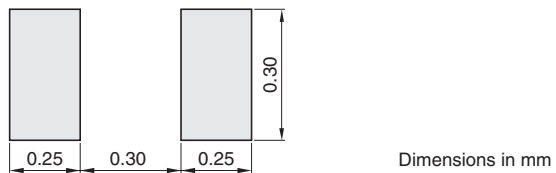

Dimensions in mm

 Please be sure to request delivery specifications that provide further details on the features and specifications of the products for proper and safe use. Please note that the contents may change without any prior notice due to reasons such as upgrading.

MHQ-P_{series} **MHQ0603P Type**

■ ELECTRICAL CHARACTERISTICS

□ CHARACTERISTICS SPECIFICATION TABLE

L (nH)	Tolerance	L measuring frequency (MHz)	Q min.	Q measuring frequency (MHz)	Self-resonant frequency (GHz)		DC resistance (Ω)		Rated current (mA) max.	Part No.
					min.	typ.	max.	typ.		
0.6	± 0.1 nH	500	—	500	10.0	20.0	0.07	0.02	1000	MHQ0603P0N6BT000
0.6	± 0.2 nH	500	—	500	10.0	20.0	0.07	0.02	1000	MHQ0603P0N6CT000
0.7	± 0.1 nH	500	—	500	10.0	20.0	0.07	0.02	1000	MHQ0603P0N7BT000
0.7	± 0.2 nH	500	—	500	10.0	20.0	0.07	0.02	1000	MHQ0603P0N7CT000
0.8	± 0.1 nH	500	—	500	10.0	20.0	0.07	0.02	1000	MHQ0603P0N8BT000
0.8	± 0.2 nH	500	—	500	10.0	20.0	0.07	0.02	1000	MHQ0603P0N8CT000
0.9	± 0.1 nH	500	—	500	10.0	18.8	0.07	0.02	1000	MHQ0603P0N9BT000
0.9	± 0.2 nH	500	—	500	10.0	18.8	0.07	0.02	1000	MHQ0603P0N9CT000
1.0	± 0.1 nH	500	—	500	10.0	19.3	0.07	0.03	1000	MHQ0603P1N0BT000
1.0	± 0.2 nH	500	—	500	10.0	19.3	0.07	0.03	1000	MHQ0603P1N0CT000
1.0	± 0.3 nH	500	—	500	10.0	19.3	0.07	0.03	1000	MHQ0603P1N0ST000
1.1	± 0.1 nH	500	—	500	10.0	19.3	0.07	0.03	1000	MHQ0603P1N1BT000
1.1	± 0.2 nH	500	—	500	10.0	19.3	0.07	0.03	1000	MHQ0603P1N1CT000
1.1	± 0.3 nH	500	—	500	10.0	19.3	0.07	0.03	1000	MHQ0603P1N1ST000
1.2	± 0.1 nH	500	—	500	10.0	20.0	0.08	0.04	1000	MHQ0603P1N2BT000
1.2	± 0.2 nH	500	—	500	10.0	20.0	0.08	0.04	1000	MHQ0603P1N2CT000
1.2	± 0.3 nH	500	—	500	10.0	20.0	0.08	0.04	1000	MHQ0603P1N2ST000
1.3	± 0.1 nH	500	—	500	10.0	20.0	0.10	0.06	800	MHQ0603P1N3BT000
1.3	± 0.2 nH	500	—	500	10.0	20.0	0.10	0.06	800	MHQ0603P1N3CT000
1.3	± 0.3 nH	500	—	500	10.0	20.0	0.10	0.06	800	MHQ0603P1N3ST000
1.4	± 0.1 nH	500	—	500	10.0	18.6	0.10	0.06	800	MHQ0603P1N4BT000
1.4	± 0.2 nH	500	—	500	10.0	18.6	0.10	0.06	800	MHQ0603P1N4CT000
1.4	± 0.3 nH	500	—	500	10.0	18.6	0.10	0.06	800	MHQ0603P1N4ST000
1.5	± 0.1 nH	500	16	500	10.0	19.5	0.10	0.05	800	MHQ0603P1N5BT000
1.5	± 0.2 nH	500	16	500	10.0	19.5	0.10	0.05	800	MHQ0603P1N5CT000
1.5	± 0.3 nH	500	16	500	10.0	19.5	0.10	0.05	800	MHQ0603P1N5ST000
1.6	± 0.1 nH	500	16	500	10.0	17.5	0.10	0.06	800	MHQ0603P1N6BT000
1.6	± 0.2 nH	500	16	500	10.0	17.5	0.10	0.06	800	MHQ0603P1N6CT000
1.6	± 0.3 nH	500	16	500	10.0	17.5	0.10	0.06	800	MHQ0603P1N6ST000
1.7	± 0.1 nH	500	16	500	10.0	16.7	0.10	0.07	800	MHQ0603P1N7BT000
1.7	± 0.2 nH	500	16	500	10.0	16.7	0.10	0.07	800	MHQ0603P1N7CT000
1.7	± 0.3 nH	500	16	500	10.0	16.7	0.10	0.07	800	MHQ0603P1N7ST000
1.8	± 0.1 nH	500	16	500	10.0	15.8	0.12	0.07	700	MHQ0603P1N8BT000
1.8	± 0.2 nH	500	16	500	10.0	15.8	0.12	0.07	700	MHQ0603P1N8CT000
1.8	± 0.3 nH	500	16	500	10.0	15.8	0.12	0.07	700	MHQ0603P1N8ST000
1.9	± 0.1 nH	500	16	500	10.0	16.1	0.12	0.08	700	MHQ0603P1N9BT000
1.9	± 0.2 nH	500	16	500	10.0	16.1	0.12	0.08	700	MHQ0603P1N9CT000
1.9	± 0.3 nH	500	16	500	10.0	16.1	0.12	0.08	700	MHQ0603P1N9ST000
2.0	± 0.1 nH	500	16	500	10.0	13.8	0.12	0.08	700	MHQ0603P2N0BT000
2.0	± 0.2 nH	500	16	500	10.0	13.8	0.12	0.08	700	MHQ0603P2N0CT000
2.0	± 0.3 nH	500	16	500	10.0	13.8	0.12	0.08	700	MHQ0603P2N0ST000
2.1	± 0.1 nH	500	16	500	10.0	12.7	0.15	0.08	700	MHQ0603P2N1BT000
2.1	± 0.2 nH	500	16	500	10.0	12.7	0.15	0.08	700	MHQ0603P2N1CT000
2.1	± 0.3 nH	500	16	500	10.0	12.7	0.15	0.08	700	MHQ0603P2N1ST000

· Short bar residual inductance =0.48nH

○ Measurement equipment

Measurement item	Product No.	Manufacturer
L, Q	4991A+16197A	Agilent Technologies
Self-resonant frequency	8720C	Agilent Technologies
DC resistance	Type-7561	Yokogawa

* Equivalent measurement equipment may be used.

⚠ Please be sure to request delivery specifications that provide further details on the features and specifications of the products for proper and safe use.
Please note that the contents may change without any prior notice due to reasons such as upgrading.

MHQ-P_{series} **MHQ0603P Type**

■ ELECTRICAL CHARACTERISTICS

□ CHARACTERISTICS SPECIFICATION TABLE

L (nH)	Tolerance	L measuring frequency (MHz)	Q min.	Q measuring frequency (MHz)	Self-resonant frequency (GHz)		DC resistance (Ω)		Rated current (mA) max.	Part No.
					min.	typ.	max.	typ.		
2.2	±0.1nH	500	16	500	10.0	13.2	0.15	0.09	700	MHQ0603P2N2BT000
2.2	±0.2nH	500	16	500	10.0	13.2	0.15	0.09	700	MHQ0603P2N2CT000
2.2	±0.3nH	500	16	500	10.0	13.2	0.15	0.09	700	MHQ0603P2N2ST000
2.3	±0.1nH	500	16	500	10.0	12.5	0.15	0.08	700	MHQ0603P2N3BT000
2.3	±0.2nH	500	16	500	10.0	12.5	0.15	0.08	700	MHQ0603P2N3CT000
2.3	±0.3nH	500	16	500	10.0	12.5	0.15	0.08	700	MHQ0603P2N3ST000
2.4	±0.1nH	500	16	500	8.0	11.7	0.15	0.08	700	MHQ0603P2N4BT000
2.4	±0.2nH	500	16	500	8.0	11.7	0.15	0.08	700	MHQ0603P2N4CT000
2.4	±0.3nH	500	16	500	8.0	11.7	0.15	0.08	700	MHQ0603P2N4ST000
2.5	±0.1nH	500	16	500	8.0	11.1	0.25	0.17	500	MHQ0603P2N5BT000
2.5	±0.2nH	500	16	500	8.0	11.1	0.25	0.17	500	MHQ0603P2N5CT000
2.5	±0.3nH	500	16	500	8.0	11.1	0.25	0.17	500	MHQ0603P2N5ST000
2.6	±0.1nH	500	16	500	8.0	11.1	0.25	0.16	500	MHQ0603P2N6BT000
2.6	±0.2nH	500	16	500	8.0	11.1	0.25	0.16	500	MHQ0603P2N6CT000
2.6	±0.3nH	500	16	500	8.0	11.1	0.25	0.16	500	MHQ0603P2N6ST000
2.7	±0.1nH	500	16	500	8.0	10.5	0.25	0.16	500	MHQ0603P2N7BT000
2.7	±0.2nH	500	16	500	8.0	10.5	0.25	0.16	500	MHQ0603P2N7CT000
2.7	±0.3nH	500	16	500	8.0	10.5	0.25	0.16	500	MHQ0603P2N7ST000
2.8	±0.1nH	500	16	500	8.0	10.6	0.25	0.18	500	MHQ0603P2N8BT000
2.8	±0.2nH	500	16	500	8.0	10.6	0.25	0.18	500	MHQ0603P2N8CT000
2.8	±0.3nH	500	16	500	8.0	10.6	0.25	0.18	500	MHQ0603P2N8ST000
2.9	±0.1nH	500	16	500	8.0	10.8	0.30	0.19	450	MHQ0603P2N9BT000
2.9	±0.2nH	500	16	500	8.0	10.8	0.30	0.19	450	MHQ0603P2N9CT000
2.9	±0.3nH	500	16	500	8.0	10.8	0.30	0.19	450	MHQ0603P2N9ST000
3.0	±0.1nH	500	16	500	8.0	10.3	0.30	0.19	450	MHQ0603P3N0BT000
3.0	±0.2nH	500	16	500	8.0	10.3	0.30	0.19	450	MHQ0603P3N0CT000
3.0	±0.3nH	500	16	500	8.0	10.3	0.30	0.19	450	MHQ0603P3N0ST000
3.1	±0.1nH	500	16	500	8.0	10.5	0.30	0.19	450	MHQ0603P3N1BT000
3.1	±0.2nH	500	16	500	8.0	10.5	0.30	0.19	450	MHQ0603P3N1CT000
3.1	±0.3nH	500	16	500	8.0	10.5	0.30	0.19	450	MHQ0603P3N1ST000
3.2	±0.1nH	500	16	500	7.0	9.5	0.20	0.13	550	MHQ0603P3N2BT000
3.2	±0.2nH	500	16	500	7.0	9.5	0.20	0.13	550	MHQ0603P3N2CT000
3.2	±0.3nH	500	16	500	7.0	9.5	0.20	0.13	550	MHQ0603P3N2ST000
3.3	±0.1nH	500	16	500	7.0	9.6	0.25	0.15	500	MHQ0603P3N3BT000
3.3	±0.2nH	500	16	500	7.0	9.6	0.25	0.15	500	MHQ0603P3N3CT000
3.3	±0.3nH	500	16	500	7.0	9.6	0.25	0.15	500	MHQ0603P3N3ST000
3.4	±0.1nH	500	16	500	6.5	9.3	0.25	0.14	500	MHQ0603P3N4BT000
3.4	±0.2nH	500	16	500	6.5	9.3	0.25	0.14	500	MHQ0603P3N4CT000
3.4	±0.3nH	500	16	500	6.5	9.3	0.25	0.14	500	MHQ0603P3N4ST000
3.5	±0.1nH	500	16	500	6.5	9.5	0.25	0.17	500	MHQ0603P3N5BT000
3.5	±0.2nH	500	16	500	6.5	9.5	0.25	0.17	500	MHQ0603P3N5CT000
3.5	±0.3nH	500	16	500	6.5	9.5	0.25	0.17	500	MHQ0603P3N5ST000
3.6	±0.1nH	500	16	500	6.5	9.1	0.25	0.16	500	MHQ0603P3N6BT000
3.6	±0.2nH	500	16	500	6.5	9.1	0.25	0.16	500	MHQ0603P3N6CT000
3.6	±0.3nH	500	16	500	6.5	9.1	0.25	0.16	500	MHQ0603P3N6ST000

∩ Short bar residual inductance =0.48nH

○ Measurement equipment

Measurement item	Product No.	Manufacturer
L, Q	4991A+16197A	Agilent Technologies
Self-resonant frequency	8720C	Agilent Technologies
DC resistance	Type-7561	Yokogawa

* Equivalent measurement equipment may be used.

⚠ Please be sure to request delivery specifications that provide further details on the features and specifications of the products for proper and safe use.
Please note that the contents may change without any prior notice due to reasons such as upgrading.

MHQ-P_{series} **MHQ0603P Type**

■ ELECTRICAL CHARACTERISTICS

□ CHARACTERISTICS SPECIFICATION TABLE

L (nH)	Tolerance	L measuring frequency (MHz)	Q min.	Q measuring frequency (MHz)	Self-resonant frequency (GHz)		DC resistance (Ω)		Rated current (mA) max.	Part No.
					min.	typ.	max.	typ.		
3.7	± 0.1 nH	500	16	500	6.5	9.1	0.25	0.17	450	MHQ0603P3N7BT000
3.7	± 0.2 nH	500	16	500	6.5	9.1	0.25	0.17	450	MHQ0603P3N7CT000
3.7	± 0.3 nH	500	16	500	6.5	9.1	0.25	0.17	450	MHQ0603P3N7ST000
3.8	± 0.1 nH	500	16	500	6.5	9.1	0.30	0.19	450	MHQ0603P3N8BT000
3.8	± 0.2 nH	500	16	500	6.5	9.1	0.30	0.19	450	MHQ0603P3N8CT000
3.8	± 0.3 nH	500	16	500	6.5	9.1	0.30	0.19	450	MHQ0603P3N8ST000
3.9	± 0.1 nH	500	16	500	6.5	9.2	0.35	0.23	400	MHQ0603P3N9BT000
3.9	± 0.2 nH	500	16	500	6.5	9.2	0.35	0.23	400	MHQ0603P3N9CT000
3.9	± 0.3 nH	500	16	500	6.5	9.2	0.35	0.23	400	MHQ0603P3N9ST000
4.0	± 0.1 nH	500	16	500	6.0	8.5	0.35	0.26	400	MHQ0603P4N0BT000
4.0	± 0.2 nH	500	16	500	6.0	8.5	0.35	0.26	400	MHQ0603P4N0CT000
4.0	± 0.3 nH	500	16	500	6.0	8.5	0.35	0.26	400	MHQ0603P4N0ST000
4.1	± 0.1 nH	500	16	500	6.0	8.3	0.35	0.22	400	MHQ0603P4N1BT000
4.1	± 0.2 nH	500	16	500	6.0	8.3	0.35	0.22	400	MHQ0603P4N1CT000
4.1	± 0.3 nH	500	16	500	6.0	8.3	0.35	0.22	400	MHQ0603P4N1ST000
4.2	± 0.1 nH	500	16	500	6.0	8.2	0.35	0.23	400	MHQ0603P4N2BT000
4.2	± 0.2 nH	500	16	500	6.0	8.2	0.35	0.23	400	MHQ0603P4N2CT000
4.2	± 0.3 nH	500	16	500	6.0	8.2	0.35	0.23	400	MHQ0603P4N2ST000
4.3	± 0.2 nH	500	16	500	6.0	8.2	0.35	0.23	400	MHQ0603P4N3CT000
4.3	± 0.3 nH	500	16	500	6.0	8.2	0.35	0.23	400	MHQ0603P4N3ST000
4.3	$\pm 3\%$	500	16	500	6.0	8.2	0.35	0.23	400	MHQ0603P4N3HT000
4.7	± 0.2 nH	500	16	500	5.5	7.9	0.40	0.25	350	MHQ0603P4N7CT000
4.7	± 0.3 nH	500	16	500	5.5	7.9	0.40	0.25	350	MHQ0603P4N7ST000
4.7	$\pm 3\%$	500	16	500	5.5	7.9	0.40	0.25	350	MHQ0603P4N7HT000
5.1	± 0.2 nH	500	16	500	5.5	7.8	0.40	0.24	350	MHQ0603P5N1CT000
5.1	± 0.3 nH	500	16	500	5.5	7.8	0.40	0.24	350	MHQ0603P5N1ST000
5.1	$\pm 3\%$	500	16	500	5.5	7.8	0.40	0.24	350	MHQ0603P5N1HT000
5.6	± 0.2 nH	500	16	500	5.0	7.1	0.40	0.29	350	MHQ0603P5N6CT000
5.6	± 0.3 nH	500	16	500	5.0	7.1	0.40	0.29	350	MHQ0603P5N6ST000
5.6	$\pm 3\%$	500	16	500	5.0	7.1	0.40	0.29	350	MHQ0603P5N6HT000
6.2	± 0.3 nH	500	16	500	4.0	6.7	0.70	0.52	300	MHQ0603P6N2ST000
6.2	$\pm 3\%$	500	16	500	4.0	6.7	0.70	0.52	300	MHQ0603P6N2HT000
6.8	$\pm 3\%$	500	16	500	4.0	6.8	0.70	0.53	300	MHQ0603P6N8HT000
6.8	$\pm 5\%$	500	16	500	4.0	6.8	0.70	0.53	300	MHQ0603P6N8JT000
7.5	$\pm 3\%$	500	16	500	3.8	5.7	0.50	0.37	300	MHQ0603P7N5HT000
7.5	$\pm 5\%$	500	16	500	3.8	5.7	0.50	0.37	300	MHQ0603P7N5JT000
8.2	$\pm 3\%$	500	16	500	3.8	5.4	0.90	0.64	250	MHQ0603P8N2HT000
8.2	$\pm 5\%$	500	16	500	3.8	5.4	0.90	0.64	250	MHQ0603P8N2JT000
9.1	$\pm 3\%$	500	16	500	3.8	5.5	0.90	0.62	250	MHQ0603P9N1HT000
9.1	$\pm 5\%$	500	16	500	3.8	5.5	0.90	0.62	250	MHQ0603P9N1JT000
10	$\pm 3\%$	500	16	500	3.5	5.2	1.20	0.86	240	MHQ0603P10NHT000
10	$\pm 5\%$	500	16	500	3.5	5.2	1.20	0.86	240	MHQ0603P10NJT000
11	$\pm 3\%$	500	16	500	3.2	4.6	1.30	0.89	240	MHQ0603P11NHT000
11	$\pm 5\%$	500	16	500	3.2	4.6	1.30	0.89	240	MHQ0603P11NJT000

· Short bar residual inductance =0.48nH

○ Measurement equipment

Measurement item	Product No.	Manufacturer
L, Q	4991A+16197A	Agilent Technologies
Self-resonant frequency	8720C	Agilent Technologies
DC resistance	Type-7561	Yokogawa

* Equivalent measurement equipment may be used.

⚠ Please be sure to request delivery specifications that provide further details on the features and specifications of the products for proper and safe use.
Please note that the contents may change without any prior notice due to reasons such as upgrading.

MHQ-P_{series} MHQ0603P Type

■ ELECTRICAL CHARACTERISTICS

□ CHARACTERISTICS SPECIFICATION TABLE

L (nH)	Tolerance	L measuring frequency (MHz)	Q min.	Q measuring frequency (MHz)	Self-resonant frequency (GHz)		DC resistance (Ω)		Rated current (mA) max.	Part No.
					min.	typ.	max.	typ.		
12	±3%	500	16	500	3.2	4.6	1.40	0.77	240	MHQ0603P12NHT000
12	±5%	500	16	500	3.2	4.6	1.40	0.77	240	MHQ0603P12NJT000
13	±3%	500	16	500	3.2	4.5	1.50	1.01	180	MHQ0603P13NHT000
13	±5%	500	16	500	3.2	4.5	1.50	1.01	180	MHQ0603P13NJT000
15	±3%	500	16	500	2.8	4.2	1.50	1.05	180	MHQ0603P15NHT000
15	±5%	500	16	500	2.8	4.2	1.50	1.05	180	MHQ0603P15NJT000
16	±3%	500	16	500	2.5	4.0	1.70	1.21	180	MHQ0603P16NHT000
16	±5%	500	16	500	2.5	4.0	1.70	1.21	180	MHQ0603P16NJT000
18	±3%	500	16	500	2.4	3.7	1.70	1.21	180	MHQ0603P18NHT000
18	±5%	500	16	500	2.4	3.7	1.70	1.21	180	MHQ0603P18NJT000
20	±3%	500	16	500	2.4	3.5	2.00	1.38	160	MHQ0603P20NHT000
20	±5%	500	16	500	2.4	3.5	2.00	1.38	160	MHQ0603P20NJT000
22	±3%	500	16	500	2.2	3.3	2.00	1.40	160	MHQ0603P22NHT000
22	±5%	500	16	500	2.2	3.3	2.00	1.40	160	MHQ0603P22NJT000
24	±3%	500	16	500	2.1	3.1	2.20	1.55	160	MHQ0603P24NHT000
24	±5%	500	16	500	2.1	3.1	2.20	1.55	160	MHQ0603P24NJT000
27	±3%	500	16	500	2.0	2.9	2.20	1.55	160	MHQ0603P27NHT000
27	±5%	500	16	500	2.0	2.9	2.20	1.55	160	MHQ0603P27NJT000
30	±3%	500	16	500	1.9	2.7	2.70	1.98	160	MHQ0603P30NHT000
30	±5%	500	16	500	1.9	2.7	2.70	1.98	160	MHQ0603P30NJT000
33	±3%	300	14	300	1.8	2.5	2.80	2.06	160	MHQ0603P33NHT000
33	±5%	300	14	300	1.8	2.5	2.80	2.06	160	MHQ0603P33NJT000
36	±3%	300	14	300	1.7	2.4	2.80	2.08	160	MHQ0603P36NHT000
36	±5%	300	14	300	1.7	2.4	2.80	2.08	160	MHQ0603P36NJT000
39	±3%	300	14	300	1.6	2.3	3.00	2.24	160	MHQ0603P39NHT000
39	±5%	300	14	300	1.6	2.3	3.00	2.24	160	MHQ0603P39NJT000

· Short bar residual inductance =0.48nH

○ Measurement equipment

Measurement item	Product No.	Manufacturer
L, Q	4991A+16197A	Agilent Technologies
Self-resonant frequency	8720C	Agilent Technologies
DC resistance	Type-7561	Yokogawa

* Equivalent measurement equipment may be used.

MHQ-P_{series} MHQ0603P Type

■ ELECTRICAL CHARACTERISTICS

□ L, Q FREQUENCY CHARACTERISTICS TABLE

L(nH)typ.					Q typ.					Part No.
500MHz	800MHz	1.8GHz	2.0GHz	2.4GHz	500MHz	800MHz	1.8GHz	2.0GHz	2.4GHz	
0.6	0.6	0.6	0.6	0.6	29min.	38min.	58min.	60min.	66min.	MHQ0603P0N6BT000
0.6	0.6	0.6	0.6	0.6	29min.	38min.	58min.	60min.	66min.	MHQ0603P0N6CT000
0.7	0.7	0.7	0.7	0.7	29min.	38min.	58min.	60min.	66min.	MHQ0603P0N7BT000
0.7	0.7	0.7	0.7	0.7	29min.	38min.	58min.	60min.	66min.	MHQ0603P0N7CT000
0.8	0.8	0.8	0.8	0.8	29min.	38min.	58min.	60min.	66min.	MHQ0603P0N8BT000
0.8	0.8	0.8	0.8	0.8	29min.	38min.	58min.	60min.	66min.	MHQ0603P0N8CT000
0.9	0.9	0.9	0.9	0.9	29min.	38min.	58min.	60min.	66min.	MHQ0603P0N9BT000
0.9	0.9	0.9	0.9	0.9	29min.	38min.	58min.	60min.	66min.	MHQ0603P0N9CT000
1.0	1.0	1.0	1.0	1.0	29min.	38min.	58min.	60min.	66min.	MHQ0603P1N0BT000
1.0	1.0	1.0	1.0	1.0	29min.	38min.	58min.	60min.	66min.	MHQ0603P1N0CT000
1.0	1.0	1.0	1.0	1.0	29min.	38min.	58min.	60min.	66min.	MHQ0603P1N0ST000
1.1	1.1	1.1	1.1	1.1	29min.	38min.	58min.	60min.	66min.	MHQ0603P1N1BT000
1.1	1.1	1.1	1.1	1.1	29min.	38min.	58min.	60min.	66min.	MHQ0603P1N1CT000
1.1	1.1	1.1	1.1	1.1	29min.	38min.	58min.	60min.	66min.	MHQ0603P1N1ST000
1.2	1.2	1.2	1.2	1.2	29min.	38min.	58min.	60min.	66min.	MHQ0603P1N2BT000
1.2	1.2	1.2	1.2	1.2	29min.	38min.	58min.	60min.	66min.	MHQ0603P1N2CT000
1.2	1.2	1.2	1.2	1.2	29min.	38min.	58min.	60min.	66min.	MHQ0603P1N2ST000
1.3	1.3	1.3	1.3	1.3	29min.	38min.	58min.	60min.	66min.	MHQ0603P1N3BT000
1.3	1.3	1.3	1.3	1.3	29min.	38min.	58min.	60min.	66min.	MHQ0603P1N3CT000
1.3	1.3	1.3	1.3	1.3	29min.	38min.	58min.	60min.	66min.	MHQ0603P1N3ST000
1.4	1.4	1.4	1.4	1.4	29min.	38min.	58min.	60min.	66min.	MHQ0603P1N4BT000
1.4	1.4	1.4	1.4	1.4	29min.	38min.	58min.	60min.	66min.	MHQ0603P1N4CT000
1.4	1.4	1.4	1.4	1.4	29min.	38min.	58min.	60min.	66min.	MHQ0603P1N4ST000
1.5	1.5	1.5	1.5	1.5	29	38	58	60	66	MHQ0603P1N5BT000
1.5	1.5	1.5	1.5	1.5	29	38	58	60	66	MHQ0603P1N5CT000
1.5	1.5	1.5	1.5	1.5	29	38	58	60	66	MHQ0603P1N5ST000
1.6	1.6	1.6	1.6	1.6	28	37	56	60	66	MHQ0603P1N6BT000
1.6	1.6	1.6	1.6	1.6	28	37	56	60	66	MHQ0603P1N6CT000
1.6	1.6	1.6	1.6	1.6	28	37	56	60	66	MHQ0603P1N6ST000
1.7	1.7	1.7	1.7	1.7	30	39	62	65	71	MHQ0603P1N7BT000
1.7	1.7	1.7	1.7	1.7	30	39	62	65	71	MHQ0603P1N7CT000
1.7	1.7	1.7	1.7	1.7	30	39	62	65	71	MHQ0603P1N7ST000
1.8	1.8	1.8	1.8	1.8	29	38	59	62	69	MHQ0603P1N8BT000
1.8	1.8	1.8	1.8	1.8	29	38	59	62	69	MHQ0603P1N8CT000
1.8	1.8	1.8	1.8	1.8	29	38	59	62	69	MHQ0603P1N8ST000
1.9	1.9	1.9	1.9	1.9	28	38	57	60	66	MHQ0603P1N9BT000
1.9	1.9	1.9	1.9	1.9	28	38	57	60	66	MHQ0603P1N9CT000
1.9	1.9	1.9	1.9	1.9	28	38	57	60	66	MHQ0603P1N9ST000
2.0	2.0	2.0	2.0	2.0	27	35	55	58	64	MHQ0603P2N0BT000
2.0	2.0	2.0	2.0	2.0	27	35	55	58	64	MHQ0603P2N0CT000
2.0	2.0	2.0	2.0	2.0	27	35	55	58	64	MHQ0603P2N0ST000
2.1	2.1	2.1	2.1	2.2	29	37	58	62	68	MHQ0603P2N1BT000
2.1	2.1	2.1	2.1	2.2	29	37	58	62	68	MHQ0603P2N1CT000
2.1	2.1	2.1	2.1	2.2	29	37	58	62	68	MHQ0603P2N1ST000

○ Measurement equipment

Product No.	Manufacturer
4291B+16193A	Agilent Technologies

* Equivalent measurement equipment may be used.

 Please be sure to request delivery specifications that provide further details on the features and specifications of the products for proper and safe use. Please note that the contents may change without any prior notice due to reasons such as upgrading.

MHQ-P_{series} MHQ0603P Type

■ ELECTRICAL CHARACTERISTICS

□ L, Q FREQUENCY CHARACTERISTICS TABLE

L(nH)typ.					Q typ.					Part No.
500MHz	800MHz	1.8GHz	2.0GHz	2.4GHz	500MHz	800MHz	1.8GHz	2.0GHz	2.4GHz	
2.2	2.2	2.2	2.2	2.3	28	37	57	61	68	MHQ0603P2N2BT000
2.2	2.2	2.2	2.2	2.3	28	37	57	61	68	MHQ0603P2N2CT000
2.2	2.2	2.2	2.2	2.3	28	37	57	61	68	MHQ0603P2N2ST000
2.3	2.3	2.3	2.3	2.4	31	40	61	64	71	MHQ0603P2N3BT000
2.3	2.3	2.3	2.3	2.4	31	40	61	64	71	MHQ0603P2N3CT000
2.3	2.3	2.3	2.3	2.4	31	40	61	64	71	MHQ0603P2N3ST000
2.4	2.4	2.4	2.4	2.5	31	41	62	64	71	MHQ0603P2N4BT000
2.4	2.4	2.4	2.4	2.5	31	41	62	64	71	MHQ0603P2N4CT000
2.4	2.4	2.4	2.4	2.5	31	41	62	64	71	MHQ0603P2N4ST000
2.5	2.5	2.5	2.6	2.6	25	32	51	53	59	MHQ0603P2N5BT000
2.5	2.5	2.5	2.6	2.6	25	32	51	53	59	MHQ0603P2N5CT000
2.5	2.5	2.5	2.6	2.6	25	32	51	53	59	MHQ0603P2N5ST000
2.6	2.6	2.6	2.7	2.7	26	34	54	56	62	MHQ0603P2N6BT000
2.6	2.6	2.6	2.7	2.7	26	34	54	56	62	MHQ0603P2N6CT000
2.6	2.6	2.6	2.7	2.7	26	34	54	56	62	MHQ0603P2N6ST000
2.7	2.7	2.7	2.8	2.8	26	34	54	57	63	MHQ0603P2N7BT000
2.7	2.7	2.7	2.8	2.8	26	34	54	57	63	MHQ0603P2N7CT000
2.7	2.7	2.7	2.8	2.8	26	34	54	57	63	MHQ0603P2N7ST000
2.8	2.8	2.8	2.9	2.9	26	35	54	55	62	MHQ0603P2N8BT000
2.8	2.8	2.8	2.9	2.9	26	35	54	55	62	MHQ0603P2N8CT000
2.8	2.8	2.8	2.9	2.9	26	35	54	55	62	MHQ0603P2N8ST000
2.9	2.9	2.9	3.0	3.0	24	31	48	51	56	MHQ0603P2N9BT000
2.9	2.9	2.9	3.0	3.0	24	31	48	51	56	MHQ0603P2N9CT000
2.9	2.9	2.9	3.0	3.0	24	31	48	51	56	MHQ0603P2N9ST000
3.0	3.0	3.0	3.1	3.1	23	30	46	48	52	MHQ0603P3N0BT000
3.0	3.0	3.0	3.1	3.1	23	30	46	48	52	MHQ0603P3N0CT000
3.0	3.0	3.0	3.1	3.1	23	30	46	48	52	MHQ0603P3N0ST000
3.1	3.1	3.2	3.2	3.2	24	32	49	51	57	MHQ0603P3N1BT000
3.1	3.1	3.2	3.2	3.2	24	32	49	51	57	MHQ0603P3N1CT000
3.1	3.1	3.2	3.2	3.2	24	32	49	51	57	MHQ0603P3N1ST000
3.2	3.2	3.3	3.3	3.4	27	35	53	55	61	MHQ0603P3N2BT000
3.2	3.2	3.3	3.3	3.4	27	35	53	55	61	MHQ0603P3N2CT000
3.2	3.2	3.3	3.3	3.4	27	35	53	55	61	MHQ0603P3N2ST000
3.3	3.3	3.4	3.4	3.5	25	32	48	50	54	MHQ0603P3N3BT000
3.3	3.3	3.4	3.4	3.5	25	32	48	50	54	MHQ0603P3N3CT000
3.3	3.3	3.4	3.4	3.5	25	32	48	50	54	MHQ0603P3N3ST000
3.4	3.4	3.5	3.5	3.6	27	35	53	55	61	MHQ0603P3N4BT000
3.4	3.4	3.5	3.5	3.6	27	35	53	55	61	MHQ0603P3N4CT000
3.4	3.4	3.5	3.5	3.6	27	35	53	55	61	MHQ0603P3N4ST000
3.5	3.5	3.6	3.6	3.7	25	33	50	52	57	MHQ0603P3N5BT000
3.5	3.5	3.6	3.6	3.7	25	33	50	52	57	MHQ0603P3N5CT000
3.5	3.5	3.6	3.6	3.7	25	33	50	52	57	MHQ0603P3N5ST000
3.6	3.6	3.7	3.7	3.8	26	33	50	52	57	MHQ0603P3N6BT000
3.6	3.6	3.7	3.7	3.8	26	33	50	52	57	MHQ0603P3N6CT000
3.6	3.6	3.7	3.7	3.8	26	33	50	52	57	MHQ0603P3N6ST000

○ Measurement equipment

Product No.	Manufacturer
4291B+16193A	Agilent Technologies

* Equivalent measurement equipment may be used.

 Please be sure to request delivery specifications that provide further details on the features and specifications of the products for proper and safe use. Please note that the contents may change without any prior notice due to reasons such as upgrading.

MHQ-P_{series} MHQ0603P Type

■ ELECTRICAL CHARACTERISTICS

□ L, Q FREQUENCY CHARACTERISTICS TABLE

L(nH)typ.					Q typ.					Part No.
500MHz	800MHz	1.8GHz	2.0GHz	2.4GHz	500MHz	800MHz	1.8GHz	2.0GHz	2.4GHz	
3.7	3.7	3.8	3.8	3.9	26	34	51	52	58	MHQ0603P3N7BT000
3.7	3.7	3.8	3.8	3.9	26	34	51	52	58	MHQ0603P3N7CT000
3.7	3.7	3.8	3.8	3.9	26	34	51	52	58	MHQ0603P3N7ST000
3.8	3.8	3.9	3.9	4.0	24	32	49	51	56	MHQ0603P3N8BT000
3.8	3.8	3.9	3.9	4.0	24	32	49	51	56	MHQ0603P3N8CT000
3.8	3.8	3.9	3.9	4.0	24	32	49	51	56	MHQ0603P3N8ST000
3.9	3.9	4.0	4.1	4.2	23	30	47	49	54	MHQ0603P3N9BT000
3.9	3.9	4.0	4.1	4.2	23	30	47	49	54	MHQ0603P3N9CT000
3.9	3.9	4.0	4.1	4.2	23	30	47	49	54	MHQ0603P3N9ST000
4.0	4.0	4.1	4.2	4.3	26	34	52	53	59	MHQ0603P4N0BT000
4.0	4.0	4.1	4.2	4.3	26	34	52	53	59	MHQ0603P4N0CT000
4.0	4.0	4.1	4.2	4.3	26	34	52	53	59	MHQ0603P4N0ST000
4.1	4.1	4.2	4.3	4.4	23	30	46	48	52	MHQ0603P4N1BT000
4.1	4.1	4.2	4.3	4.4	23	30	46	48	52	MHQ0603P4N1CT000
4.1	4.1	4.2	4.3	4.4	23	30	46	48	52	MHQ0603P4N1ST000
4.2	4.2	4.3	4.4	4.5	24	31	46	48	52	MHQ0603P4N2BT000
4.2	4.2	4.3	4.4	4.5	24	31	46	48	52	MHQ0603P4N2CT000
4.2	4.2	4.3	4.4	4.5	24	31	46	48	52	MHQ0603P4N2ST000
4.3	4.3	4.4	4.5	4.6	25	33	49	51	56	MHQ0603P4N3CT000
4.3	4.3	4.4	4.5	4.6	25	33	49	51	56	MHQ0603P4N3ST000
4.3	4.3	4.4	4.5	4.6	25	33	49	51	56	MHQ0603P4N3HT000
4.7	4.7	4.9	4.9	5.1	24	31	47	49	54	MHQ0603P4N7CT000
4.7	4.7	4.9	4.9	5.1	24	31	47	49	54	MHQ0603P4N7ST000
4.7	4.7	4.9	4.9	5.1	24	31	47	49	54	MHQ0603P4N7HT000
5.1	5.1	5.3	5.4	5.5	25	32	49	51	56	MHQ0603P5N1CT000
5.1	5.1	5.3	5.4	5.5	25	32	49	51	56	MHQ0603P5N1ST000
5.1	5.1	5.3	5.4	5.5	25	32	49	51	56	MHQ0603P5N1HT000
5.6	5.6	5.9	6.0	6.2	24	31	46	48	52	MHQ0603P5N6CT000
5.6	5.6	5.9	6.0	6.2	24	31	46	48	52	MHQ0603P5N6ST000
5.6	5.6	5.9	6.0	6.2	24	31	46	48	52	MHQ0603P5N6HT000
6.2	6.2	6.6	6.7	7.0	21	28	42	43	47	MHQ0603P6N2ST000
6.2	6.2	6.6	6.7	7.0	21	28	42	43	47	MHQ0603P6N2HT000
6.8	6.8	7.2	7.4	7.7	22	28	43	44	48	MHQ0603P6N8HT000
6.8	6.8	7.2	7.4	7.7	22	28	43	44	48	MHQ0603P6N8JT000
7.5	7.5	8.1	8.3	8.8	24	30	44	45	48	MHQ0603P7N5HT000
7.5	7.5	8.1	8.3	8.8	24	30	44	45	48	MHQ0603P7N5JT000
8.2	8.2	8.9	9.2	9.7	21	27	39	40	42	MHQ0603P8N2HT000
8.2	8.2	8.9	9.2	9.7	21	27	39	40	42	MHQ0603P8N2JT000
9.1	9.2	9.9	10.2	10.9	23	29	42	44	46	MHQ0603P9N1HT000
9.1	9.2	9.9	10.2	10.9	23	29	42	44	46	MHQ0603P9N1JT000
10.0	10.0	11.0	11.0	12.0	22	28	41	42	43	MHQ0603P10NHT000
10.0	10.0	11.0	11.0	12.0	22	28	41	42	43	MHQ0603P10NJT000
11.0	11.0	12.0	13.0	14.0	21	27	37	38	39	MHQ0603P11NHT000
11.0	11.0	12.0	13.0	14.0	21	27	37	38	39	MHQ0603P11NJT000

○ Measurement equipment

Product No.	Manufacturer
4291B+16193A	Agilent Technologies

* Equivalent measurement equipment may be used.

 Please be sure to request delivery specifications that provide further details on the features and specifications of the products for proper and safe use. Please note that the contents may change without any prior notice due to reasons such as upgrading.

MHQ-P_{series} **MHQ0603P Type**

■ ELECTRICAL CHARACTERISTICS

□ L, Q FREQUENCY CHARACTERISTICS TABLE

L(nH)typ.					Q typ.					Part No.
500MHz	800MHz	1.8GHz	2.0GHz	2.4GHz	500MHz	800MHz	1.8GHz	2.0GHz	2.4GHz	
12.0	12.0	14.0	14.0	16.0	23	29	41	41	41	MHQ0603P12NHT000
12.0	12.0	14.0	14.0	16.0	23	29	41	41	41	MHQ0603P12NJT000
13.0	13.0	15.0	16.0	18.0	21	27	36	36	36	MHQ0603P13NHT000
13.0	13.0	15.0	16.0	18.0	21	27	36	36	36	MHQ0603P13NJT000
15.0	15.0	18.0	19.0	21.0	23	29	37	37	36	MHQ0603P15NHT000
15.0	15.0	18.0	19.0	21.0	23	29	37	37	36	MHQ0603P15NJT000
16.0	16.0	19.0	20.0	23.0	22	28	37	37	35	MHQ0603P16NHT000
16.0	16.0	19.0	20.0	23.0	22	28	37	37	35	MHQ0603P16NJT000
18.0	18.0	22.0	24.0	28.0	23	28	36	35	33	MHQ0603P18NHT000
18.0	18.0	22.0	24.0	28.0	23	28	36	35	33	MHQ0603P18NJT000
20.0	21.0	26.0	28.0	34.0	22	27	33	32	27	MHQ0603P20NHT000
20.0	21.0	26.0	28.0	34.0	22	27	33	32	27	MHQ0603P20NJT000
22.0	23.0	29.0	32.0	40.0	23	29	34	33	28	MHQ0603P22NHT000
22.0	23.0	29.0	32.0	40.0	23	29	34	33	28	MHQ0603P22NJT000
24.0	25.0	34.0	38.0	—	22	26	29	27	—	MHQ0603P24NHT000
24.0	25.0	34.0	38.0	—	22	26	29	27	—	MHQ0603P24NJT000
27.0	28.0	38.0	44.0	—	23	28	30	28	—	MHQ0603P27NHT000
27.0	28.0	38.0	44.0	—	23	28	30	28	—	MHQ0603P27NJT000
30.0	32.0	47.0	—	—	22	27	—	—	—	MHQ0603P30NHT000
30.0	32.0	47.0	—	—	22	27	—	—	—	MHQ0603P30NJT000
33.0	35.0	55.0	—	—	22	27	—	—	—	MHQ0603P33NHT000
33.0	35.0	55.0	—	—	22	27	—	—	—	MHQ0603P33NJT000
36.0	38.0	67.0	—	—	22	26	—	—	—	MHQ0603P36NHT000
36.0	38.0	67.0	—	—	22	26	—	—	—	MHQ0603P36NJT000
39.0	42.0	79.0	—	—	23	26	—	—	—	MHQ0603P39NHT000
39.0	42.0	79.0	—	—	23	26	—	—	—	MHQ0603P39NJT000

○ Measurement equipment

Product No.	Manufacturer
4291B+16193A	Agilent Technologies

* Equivalent measurement equipment may be used.

MHQ-P_{series} MHQ0603PType

ELECTRICAL CHARACTERISTICS

L FREQUENCY CHARACTERISTICS GRAPH (EXAMPLE)

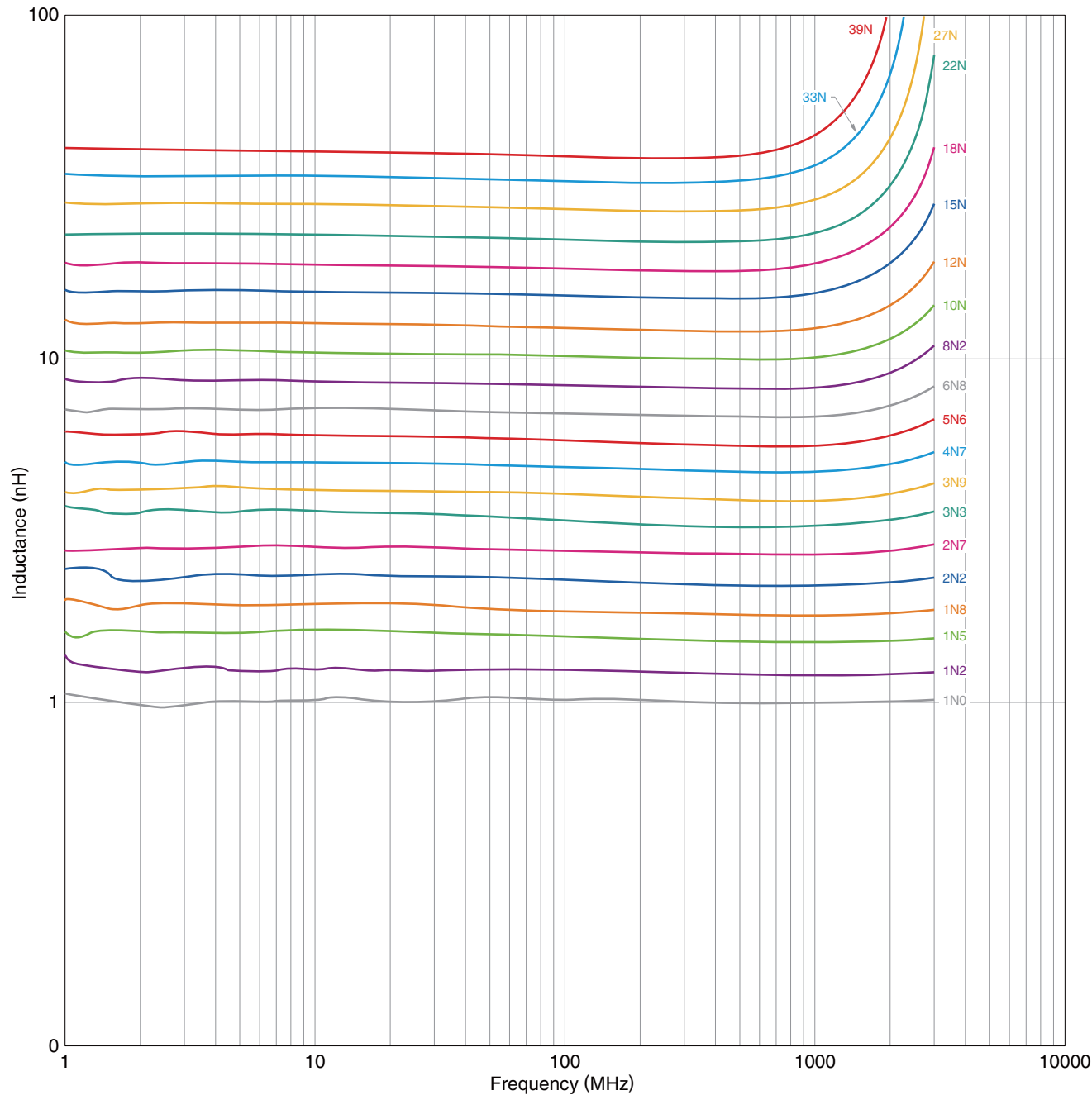

○ Measurement equipment

Product No.	Manufacturer
E4991+16193A	Agilent Technologies

* Equivalent measurement equipment may be used.

 Please be sure to request delivery specifications that provide further details on the features and specifications of the products for proper and safe use. Please note that the contents may change without any prior notice due to reasons such as upgrading.

MHQ-P_{series} MHQ0603P Type

ELECTRICAL CHARACTERISTICS

Q FREQUENCY CHARACTERISTICS GRAPH (EXAMPLE)

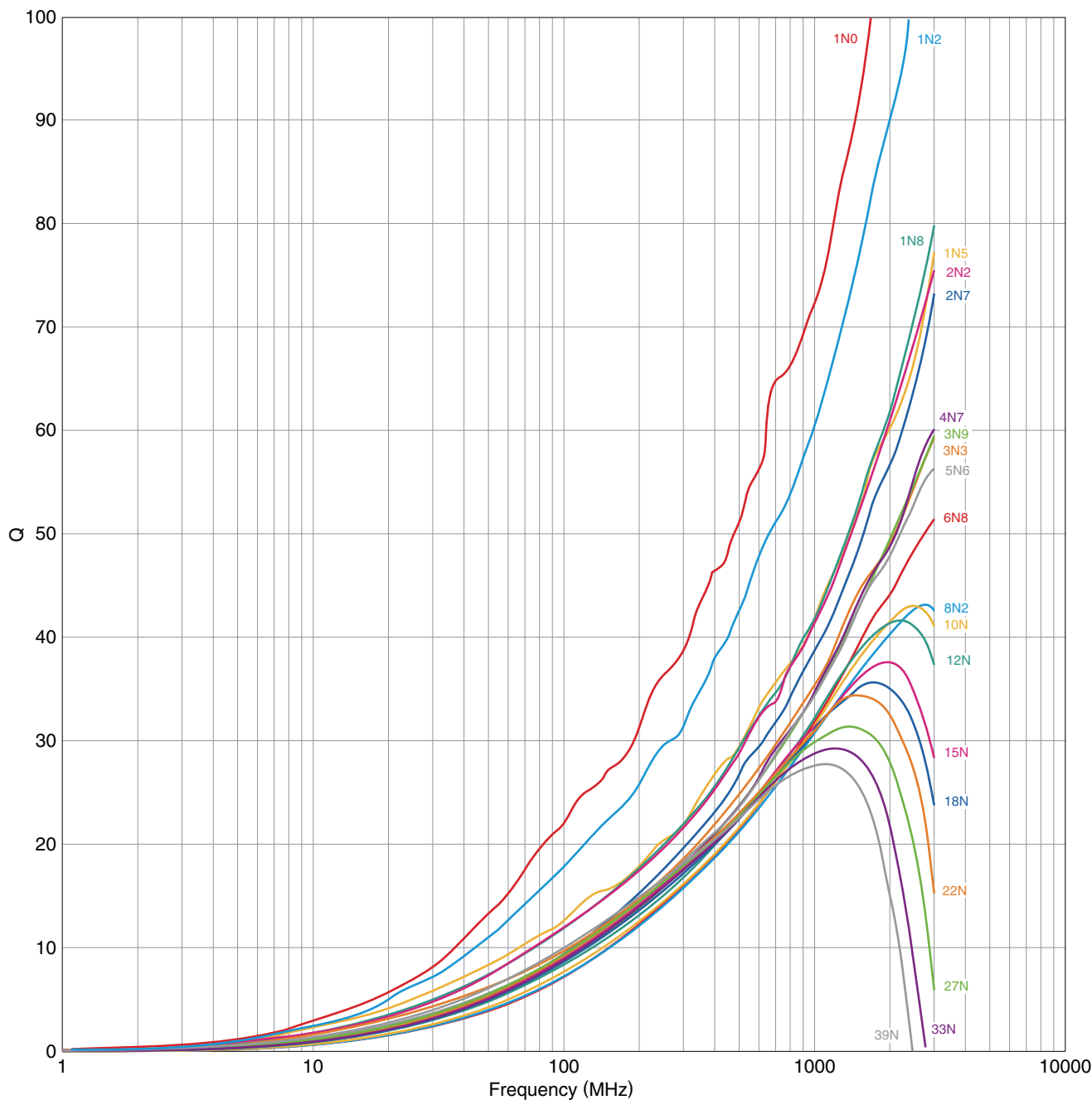

○ Measurement equipment

Product No.	Manufacturer
E4991+16193A	Agilent Technologies

* Equivalent measurement equipment may be used.

 Please be sure to request delivery specifications that provide further details on the features and specifications of the products for proper and safe use. Please note that the contents may change without any prior notice due to reasons such as upgrading.

MHQ-P_{series}

MHQ1005P Type



SHAPE & DIMENSIONS

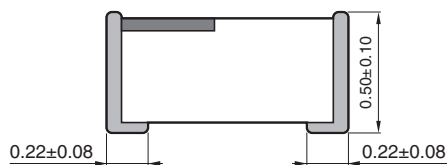
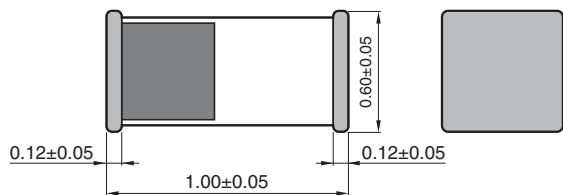

Dimensions in mm

RECOMMENDED LAND PATTERN

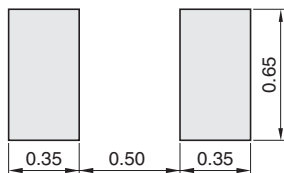

Dimensions in mm

 Please be sure to request delivery specifications that provide further details on the features and specifications of the products for proper and safe use. Please note that the contents may change without any prior notice due to reasons such as upgrading.

MHQ-P_{series} MHQ1005P Type

■ ELECTRICAL CHARACTERISTICS

□ CHARACTERISTICS SPECIFICATION TABLE

L (nH)	Tolerance	L measuring frequency (MHz)	Q min.	Q measuring frequency (MHz)	Self-resonant frequency (GHz)		DC resistance (Ω)		Rated current (mA) max.	Part No.
					min.	typ.	max.	typ.		
0.7	±0.1nH	100	—	250	15.0	18.3	0.03	0.01max.	1200	MHQ1005P0N7BT000
0.7	±0.2nH	100	—	250	15.0	18.3	0.03	0.01max.	1200	MHQ1005P0N7CT000
0.8	±0.1nH	100	—	250	15.0	18.3	0.03	0.01max.	1200	MHQ1005P0N8BT000
0.8	±0.2nH	100	—	250	15.0	18.3	0.03	0.01max.	1200	MHQ1005P0N8CT000
0.9	±0.1nH	100	—	250	15.0	18.6	0.03	0.01max.	1200	MHQ1005P0N9BT000
0.9	±0.2nH	100	—	250	15.0	18.6	0.03	0.01max.	1200	MHQ1005P0N9CT000
1.0	±0.1nH	100	—	250	15.0	20.0	0.03	0.01	1200	MHQ1005P1N0BT000
1.0	±0.2nH	100	—	250	15.0	20.0	0.03	0.01	1200	MHQ1005P1N0CT000
1.0	±0.3nH	100	—	250	15.0	20.0	0.03	0.01	1200	MHQ1005P1N0ST000
1.1	±0.1nH	100	—	250	14.0	20.0	0.03	0.02	1200	MHQ1005P1N1BT000
1.1	±0.2nH	100	—	250	14.0	20.0	0.03	0.02	1200	MHQ1005P1N1CT000
1.1	±0.3nH	100	—	250	14.0	20.0	0.03	0.02	1200	MHQ1005P1N1ST000
1.2	±0.1nH	100	—	250	13.0	20.0	0.03	0.01	1200	MHQ1005P1N2BT000
1.2	±0.2nH	100	—	250	13.0	20.0	0.03	0.01	1200	MHQ1005P1N2CT000
1.2	±0.3nH	100	—	250	13.0	20.0	0.03	0.01	1200	MHQ1005P1N2ST000
1.3	±0.1nH	100	—	250	12.0	20.0	0.03	0.01	1200	MHQ1005P1N3BT000
1.3	±0.2nH	100	—	250	12.0	20.0	0.03	0.01	1200	MHQ1005P1N3CT000
1.3	±0.3nH	100	—	250	12.0	20.0	0.03	0.01	1200	MHQ1005P1N3ST000
1.4	±0.1nH	100	23	250	12.0	20.0	0.04	0.02	1000	MHQ1005P1N4BT000
1.4	±0.2nH	100	23	250	12.0	20.0	0.04	0.02	1000	MHQ1005P1N4CT000
1.4	±0.3nH	100	23	250	12.0	20.0	0.04	0.02	1000	MHQ1005P1N4ST000
1.5	±0.1nH	100	23	250	11.0	19.7	0.04	0.02	1000	MHQ1005P1N5BT000
1.5	±0.2nH	100	23	250	11.0	19.7	0.04	0.02	1000	MHQ1005P1N5CT000
1.5	±0.3nH	100	23	250	11.0	19.7	0.04	0.02	1000	MHQ1005P1N5ST000
1.6	±0.1nH	100	23	250	10.0	15.2	0.04	0.02	1000	MHQ1005P1N6BT000
1.6	±0.2nH	100	23	250	10.0	15.2	0.04	0.02	1000	MHQ1005P1N6CT000
1.6	±0.3nH	100	23	250	10.0	15.2	0.04	0.02	1000	MHQ1005P1N6ST000
1.7	±0.1nH	100	23	250	10.0	15.4	0.04	0.02	1000	MHQ1005P1N7BT000
1.7	±0.2nH	100	23	250	10.0	15.4	0.04	0.02	1000	MHQ1005P1N7CT000
1.7	±0.3nH	100	23	250	10.0	15.4	0.04	0.02	1000	MHQ1005P1N7ST000
1.8	±0.1nH	100	23	250	9.0	15.1	0.04	0.03	1000	MHQ1005P1N8BT000
1.8	±0.2nH	100	23	250	9.0	15.1	0.04	0.03	1000	MHQ1005P1N8CT000
1.8	±0.3nH	100	23	250	9.0	15.1	0.04	0.03	1000	MHQ1005P1N8ST000
1.9	±0.1nH	100	23	250	8.0	14.8	0.05	0.03	1000	MHQ1005P1N9BT000
1.9	±0.2nH	100	23	250	8.0	14.8	0.05	0.03	1000	MHQ1005P1N9CT000
1.9	±0.3nH	100	23	250	8.0	14.8	0.05	0.03	1000	MHQ1005P1N9ST000
2.0	±0.1nH	100	23	250	8.0	11.5	0.05	0.03	1000	MHQ1005P2N0BT000
2.0	±0.2nH	100	23	250	8.0	11.5	0.05	0.03	1000	MHQ1005P2N0CT000
2.0	±0.3nH	100	23	250	8.0	11.5	0.05	0.03	1000	MHQ1005P2N0ST000
2.1	±0.1nH	100	23	250	8.0	13.1	0.06	0.04	1000	MHQ1005P2N1BT000
2.1	±0.2nH	100	23	250	8.0	13.1	0.06	0.04	1000	MHQ1005P2N1CT000
2.1	±0.3nH	100	23	250	8.0	13.1	0.06	0.04	1000	MHQ1005P2N1ST000
2.2	±0.1nH	100	23	250	8.0	12.1	0.06	0.04	1000	MHQ1005P2N2BT000
2.2	±0.2nH	100	23	250	8.0	12.1	0.06	0.04	1000	MHQ1005P2N2CT000
2.2	±0.3nH	100	23	250	8.0	12.1	0.06	0.04	1000	MHQ1005P2N2ST000

· Short bar residual inductance =0.556nH

○ Measurement equipment

Measurement item	Product No.	Manufacturer
L, Q	4291B+16193A	Agilent Technologies
Self-resonant frequency	8720C	Agilent Technologies
DC resistance	Type-7561	Yokogawa

* Equivalent measurement equipment may be used.

⚠ Please be sure to request delivery specifications that provide further details on the features and specifications of the products for proper and safe use. Please note that the contents may change without any prior notice due to reasons such as upgrading.

MHQ-P_{series} MHQ1005P Type

■ ELECTRICAL CHARACTERISTICS

□ CHARACTERISTICS SPECIFICATION TABLE

L (nH)	Tolerance	L measuring frequency (MHz)	Q min.	Q measuring frequency (MHz)	Self-resonant frequency (GHz)		DC resistance (Ω)		Rated current (mA) max.	Part No.
					min.	typ.	max.	typ.		
2.3	±0.1nH	100	23	250	7.0	10.5	0.07	0.05	1000	MHQ1005P2N3BT000
2.3	±0.2nH	100	23	250	7.0	10.5	0.07	0.05	1000	MHQ1005P2N3CT000
2.3	±0.3nH	100	23	250	7.0	10.5	0.07	0.05	1000	MHQ1005P2N3ST000
2.4	±0.1nH	100	23	250	6.5	9.8	0.06	0.04	1000	MHQ1005P2N4BT000
2.4	±0.2nH	100	23	250	6.5	9.8	0.06	0.04	1000	MHQ1005P2N4CT000
2.4	±0.3nH	100	23	250	6.5	9.8	0.06	0.04	1000	MHQ1005P2N4ST000
2.5	±0.1nH	100	23	250	6.5	10.3	0.07	0.05	900	MHQ1005P2N5BT000
2.5	±0.2nH	100	23	250	6.5	10.3	0.07	0.05	900	MHQ1005P2N5CT000
2.5	±0.3nH	100	23	250	6.5	10.3	0.07	0.05	900	MHQ1005P2N5ST000
2.6	±0.1nH	100	23	250	6.5	10.1	0.07	0.05	900	MHQ1005P2N6BT000
2.6	±0.2nH	100	23	250	6.5	10.1	0.07	0.05	900	MHQ1005P2N6CT000
2.6	±0.3nH	100	23	250	6.5	10.1	0.07	0.05	900	MHQ1005P2N6ST000
2.7	±0.1nH	100	23	250	6.5	9.6	0.07	0.04	900	MHQ1005P2N7BT000
2.7	±0.2nH	100	23	250	6.5	9.6	0.07	0.04	900	MHQ1005P2N7CT000
2.7	±0.3nH	100	23	250	6.5	9.6	0.07	0.04	900	MHQ1005P2N7ST000
2.8	±0.1nH	100	23	250	6.5	10.3	0.08	0.05	900	MHQ1005P2N8BT000
2.8	±0.2nH	100	23	250	6.5	10.3	0.08	0.05	900	MHQ1005P2N8CT000
2.8	±0.3nH	100	23	250	6.5	10.3	0.08	0.05	900	MHQ1005P2N8ST000
2.9	±0.1nH	100	23	250	6.5	9.9	0.08	0.05	900	MHQ1005P2N9BT000
2.9	±0.2nH	100	23	250	6.5	9.9	0.08	0.05	900	MHQ1005P2N9CT000
2.9	±0.3nH	100	23	250	6.5	9.9	0.08	0.05	900	MHQ1005P2N9ST000
3.0	±0.1nH	100	23	250	6.0	9.4	0.08	0.06	900	MHQ1005P3N0BT000
3.0	±0.2nH	100	23	250	6.0	9.4	0.08	0.06	900	MHQ1005P3N0CT000
3.0	±0.3nH	100	23	250	6.0	9.4	0.08	0.06	900	MHQ1005P3N0ST000
3.1	±0.1nH	100	23	250	6.0	10.3	0.09	0.06	900	MHQ1005P3N1BT000
3.1	±0.2nH	100	23	250	6.0	10.3	0.09	0.06	900	MHQ1005P3N1CT000
3.1	±0.3nH	100	23	250	6.0	10.3	0.09	0.06	900	MHQ1005P3N1ST000
3.2	±0.1nH	100	23	250	6.0	10.0	0.09	0.07	900	MHQ1005P3N2BT000
3.2	±0.2nH	100	23	250	6.0	10.0	0.09	0.07	900	MHQ1005P3N2CT000
3.2	±0.3nH	100	23	250	6.0	10.0	0.09	0.07	900	MHQ1005P3N2ST000
3.3	±0.1nH	100	23	250	6.0	9.0	0.08	0.06	900	MHQ1005P3N3BT000
3.3	±0.2nH	100	23	250	6.0	9.0	0.08	0.06	900	MHQ1005P3N3CT000
3.3	±0.3nH	100	23	250	6.0	9.0	0.08	0.06	900	MHQ1005P3N3ST000
3.4	±0.1nH	100	23	250	6.0	9.0	0.09	0.06	900	MHQ1005P3N4BT000
3.4	±0.2nH	100	23	250	6.0	9.0	0.09	0.06	900	MHQ1005P3N4CT000
3.4	±0.3nH	100	23	250	6.0	9.0	0.09	0.06	900	MHQ1005P3N4ST000
3.5	±0.1nH	100	23	250	5.8	8.8	0.09	0.07	900	MHQ1005P3N5BT000
3.5	±0.2nH	100	23	250	5.8	8.8	0.09	0.07	900	MHQ1005P3N5CT000
3.5	±0.3nH	100	23	250	5.8	8.8	0.09	0.07	900	MHQ1005P3N5ST000
3.6	±0.1nH	100	23	250	5.5	8.4	0.09	0.07	900	MHQ1005P3N6BT000
3.6	±0.2nH	100	23	250	5.5	8.4	0.09	0.07	900	MHQ1005P3N6CT000
3.6	±0.3nH	100	23	250	5.5	8.4	0.09	0.07	900	MHQ1005P3N6ST000
3.7	±0.1nH	100	23	250	5.5	8.5	0.10	0.08	900	MHQ1005P3N7BT000
3.7	±0.2nH	100	23	250	5.5	8.5	0.10	0.08	900	MHQ1005P3N7CT000
3.7	±0.3nH	100	23	250	5.5	8.5	0.10	0.08	900	MHQ1005P3N7ST000

· Short bar residual inductance =0.556nH

○ Measurement equipment

Measurement item	Product No.	Manufacturer
L, Q	4291B+16193A	Agilent Technologies
Self-resonant frequency	8720C	Agilent Technologies
DC resistance	Type-7561	Yokogawa

* Equivalent measurement equipment may be used.

 Please be sure to request delivery specifications that provide further details on the features and specifications of the products for proper and safe use. Please note that the contents may change without any prior notice due to reasons such as upgrading.

MHQ-P_{series} **MHQ1005P Type**

■ ELECTRICAL CHARACTERISTICS

□ CHARACTERISTICS SPECIFICATION TABLE

L (nH)	Tolerance	L measuring frequency (MHz)	Q min.	Q measuring frequency (MHz)	Self-resonant frequency (GHz)		DC resistance (Ω)		Rated current (mA) max.	Part No.
					min.	typ.	max.	typ.		
3.8	±0.1nH	100	23	250	5.0	7.9	0.10	0.07	900	MHQ1005P3N8BT000
3.8	±0.2nH	100	23	250	5.0	7.9	0.10	0.07	900	MHQ1005P3N8CT000
3.8	±0.3nH	100	23	250	5.0	7.9	0.10	0.07	900	MHQ1005P3N8ST000
3.9	±0.1nH	100	23	250	5.0	7.7	0.09	0.07	900	MHQ1005P3N9BT000
3.9	±0.2nH	100	23	250	5.0	7.7	0.09	0.07	900	MHQ1005P3N9CT000
3.9	±0.3nH	100	23	250	5.0	7.7	0.09	0.07	900	MHQ1005P3N9ST000
4.1	±0.1nH	100	23	250	5.0	7.7	0.10	0.07	800	MHQ1005P4N1BT000
4.1	±0.2nH	100	23	250	5.0	7.7	0.10	0.07	800	MHQ1005P4N1CT000
4.1	±0.3nH	100	23	250	5.0	7.7	0.10	0.07	800	MHQ1005P4N1ST000
4.3	±0.1nH	100	23	250	5.0	7.1	0.10	0.08	800	MHQ1005P4N3BT000
4.3	±0.2nH	100	23	250	5.0	7.1	0.10	0.08	800	MHQ1005P4N3CT000
4.3	±0.3nH	100	23	250	5.0	7.1	0.10	0.08	800	MHQ1005P4N3ST000
4.7	±0.1nH	100	23	250	5.0	7.7	0.11	0.08	800	MHQ1005P4N7BT000
4.7	±0.2nH	100	23	250	5.0	7.7	0.11	0.08	800	MHQ1005P4N7CT000
4.7	±0.3nH	100	23	250	5.0	7.7	0.11	0.08	800	MHQ1005P4N7ST000
5.1	±0.1nH	100	23	250	4.5	7.2	0.12	0.09	800	MHQ1005P5N1BT000
5.1	±0.2nH	100	23	250	4.5	7.2	0.12	0.09	800	MHQ1005P5N1CT000
5.1	±0.3nH	100	23	250	4.5	7.2	0.12	0.09	800	MHQ1005P5N1ST000
5.6	±0.1nH	100	23	250	4.5	6.5	0.13	0.10	800	MHQ1005P5N6BT000
5.6	±0.2nH	100	23	250	4.5	6.5	0.13	0.10	800	MHQ1005P5N6CT000
5.6	±0.3nH	100	23	250	4.5	6.5	0.13	0.10	800	MHQ1005P5N6ST000
5.8	±0.1nH	100	23	250	4.0	5.9	0.13	0.09	700	MHQ1005P5N8BT000
5.8	±0.2nH	100	23	250	4.0	5.9	0.13	0.09	700	MHQ1005P5N8CT000
5.8	±0.3nH	100	23	250	4.0	5.9	0.13	0.09	700	MHQ1005P5N8ST000
6.2	±0.1nH	100	23	250	4.0	5.9	0.13	0.09	700	MHQ1005P6N2BT000
6.2	±0.2nH	100	23	250	4.0	5.9	0.13	0.09	700	MHQ1005P6N2CT000
6.2	±0.3nH	100	23	250	4.0	5.9	0.13	0.09	700	MHQ1005P6N2ST000
6.8	±2%	100	23	250	4.0	5.8	0.14	0.10	700	MHQ1005P6N8GT000
6.8	±3%	100	23	250	4.0	5.8	0.14	0.10	700	MHQ1005P6N8HT000
6.8	±5%	100	23	250	4.0	5.8	0.14	0.10	700	MHQ1005P6N8JT000
7.3	±2%	100	23	250	4.0	5.7	0.17	0.13	600	MHQ1005P7N3GT000
7.3	±3%	100	23	250	4.0	5.7	0.17	0.13	600	MHQ1005P7N3HT000
7.3	±5%	100	23	250	4.0	5.7	0.17	0.13	600	MHQ1005P7N3JT000
7.5	±2%	100	23	250	4.0	5.6	0.16	0.12	600	MHQ1005P7N5GT000
7.5	±3%	100	23	250	4.0	5.6	0.16	0.12	600	MHQ1005P7N5HT000
7.5	±5%	100	23	250	4.0	5.6	0.16	0.12	600	MHQ1005P7N5JT000
8.2	±2%	100	23	250	3.6	4.9	0.16	0.12	550	MHQ1005P8N2GT000
8.2	±3%	100	23	250	3.6	4.9	0.16	0.12	550	MHQ1005P8N2HT000
8.2	±5%	100	23	250	3.6	4.9	0.16	0.12	550	MHQ1005P8N2JT000
8.7	±2%	100	23	250	3.5	4.7	0.17	0.13	550	MHQ1005P8N7GT000
8.7	±3%	100	23	250	3.5	4.7	0.17	0.13	550	MHQ1005P8N7HT000
8.7	±5%	100	23	250	3.5	4.7	0.17	0.13	550	MHQ1005P8N7JT000
9.1	±2%	100	23	250	3.4	4.5	0.17	0.13	550	MHQ1005P9N1GT000
9.1	±3%	100	23	250	3.4	4.5	0.17	0.13	550	MHQ1005P9N1HT000
9.1	±5%	100	23	250	3.4	4.5	0.17	0.13	550	MHQ1005P9N1JT000

· Short bar residual inductance =0.556nH

○ Measurement equipment

Measurement item	Product No.	Manufacturer
L, Q	4291B+16193A	Agilent Technologies
Self-resonant frequency	8720C	Agilent Technologies
DC resistance	Type-7561	Yokogawa

* Equivalent measurement equipment may be used.

⚠ Please be sure to request delivery specifications that provide further details on the features and specifications of the products for proper and safe use.
Please note that the contents may change without any prior notice due to reasons such as upgrading.

MHQ-P_{series} **MHQ1005P Type**

■ ELECTRICAL CHARACTERISTICS

□ CHARACTERISTICS SPECIFICATION TABLE

L (nH)	Tolerance	L measuring frequency (MHz)	Q min.	Q measuring frequency (MHz)	Self-resonant frequency (GHz)		DC resistance (Ω)		Rated current (mA) max.	Part No.
					min.	typ.	max.	typ.		
9.5	±2%	100	23	250	3.3	4.7	0.21	0.16	500	MHQ1005P9N5GT000
9.5	±3%	100	23	250	3.3	4.7	0.21	0.16	500	MHQ1005P9N5HT000
9.5	±5%	100	23	250	3.3	4.7	0.21	0.16	500	MHQ1005P9N5JT000
10	±2%	100	23	250	3.3	4.6	0.19	0.15	500	MHQ1005P10NGT000
10	±3%	100	23	250	3.3	4.6	0.19	0.15	500	MHQ1005P10NHT000
10	±5%	100	23	250	3.3	4.6	0.19	0.15	500	MHQ1005P10NJT000
11	±2%	100	23	250	3.0	4.2	0.24	0.20	450	MHQ1005P11NGT000
11	±3%	100	23	250	3.0	4.2	0.24	0.20	450	MHQ1005P11NHT000
11	±5%	100	23	250	3.0	4.2	0.24	0.20	450	MHQ1005P11NJT000
12	±2%	100	23	250	2.8	3.8	0.24	0.19	450	MHQ1005P12NGT000
12	±3%	100	23	250	2.8	3.8	0.24	0.19	450	MHQ1005P12NHT000
12	±5%	100	23	250	2.8	3.8	0.24	0.19	450	MHQ1005P12NJT000
13	±2%	100	23	250	2.5	3.5	0.26	0.20	420	MHQ1005P13NGT000
13	±3%	100	23	250	2.5	3.5	0.26	0.20	420	MHQ1005P13NHT000
13	±5%	100	23	250	2.5	3.5	0.26	0.20	420	MHQ1005P13NJT000
15	±2%	100	23	250	2.3	3.2	0.28	0.22	400	MHQ1005P15NGT000
15	±3%	100	23	250	2.3	3.2	0.28	0.22	400	MHQ1005P15NHT000
15	±5%	100	23	250	2.3	3.2	0.28	0.22	400	MHQ1005P15NJT000
16	±2%	100	20	250	2.3	3.5	0.80	0.57	260	MHQ1005P16NGT000
16	±3%	100	20	250	2.3	3.5	0.80	0.57	260	MHQ1005P16NHT000
16	±5%	100	20	250	2.3	3.5	0.80	0.57	260	MHQ1005P16NJT000
18	±2%	100	22	250	2.3	3.4	0.80	0.48	260	MHQ1005P18NGT000
18	±3%	100	22	250	2.3	3.4	0.80	0.48	260	MHQ1005P18NHT000
18	±5%	100	22	250	2.3	3.4	0.80	0.48	260	MHQ1005P18NJT000
19	±2%	100	20	250	2.3	3.2	0.80	0.46	260	MHQ1005P19NGT000
19	±3%	100	20	250	2.3	3.2	0.80	0.46	260	MHQ1005P19NHT000
19	±5%	100	20	250	2.3	3.2	0.80	0.46	260	MHQ1005P19NJT000
20	±2%	100	20	250	2.1	3.1	1.10	0.46	260	MHQ1005P20NGT000
20	±3%	100	20	250	2.1	3.1	1.10	0.46	260	MHQ1005P20NHT000
20	±5%	100	20	250	2.1	3.1	1.10	0.46	260	MHQ1005P20NJT000
22	±2%	100	20	250	2.1	2.9	1.10	0.66	230	MHQ1005P22NGT000
22	±3%	100	20	250	2.1	2.9	1.10	0.66	230	MHQ1005P22NHT000
22	±5%	100	20	250	2.1	2.9	1.10	0.66	230	MHQ1005P22NJT000
23	±2%	100	22	250	2.0	2.9	1.10	0.62	230	MHQ1005P23NGT000
23	±3%	100	22	250	2.0	2.9	1.10	0.62	230	MHQ1005P23NHT000
23	±5%	100	22	250	2.0	2.9	1.10	0.62	230	MHQ1005P23NJT000
24	±2%	100	20	250	2.0	2.8	1.20	0.55	230	MHQ1005P24NGT000
24	±3%	100	20	250	2.0	2.8	1.20	0.55	230	MHQ1005P24NHT000
24	±5%	100	20	250	2.0	2.8	1.20	0.55	230	MHQ1005P24NJT000
27	±2%	100	20	250	1.7	2.6	1.30	0.66	230	MHQ1005P27NGT000
27	±3%	100	20	250	1.7	2.6	1.30	0.66	230	MHQ1005P27NHT000
27	±5%	100	20	250	1.7	2.6	1.30	0.66	230	MHQ1005P27NJT000
30	±2%	100	20	250	1.7	2.4	1.30	0.80	220	MHQ1005P30NGT000
30	±3%	100	20	250	1.7	2.4	1.30	0.80	220	MHQ1005P30NHT000
30	±5%	100	20	250	1.7	2.4	1.30	0.80	220	MHQ1005P30NJT000

· Short bar residual inductance =0.556nH

○ Measurement equipment

Measurement item	Product No.	Manufacturer
L, Q	4291B+16193A	Agilent Technologies
Self-resonant frequency	8720C	Agilent Technologies
DC resistance	Type-7561	Yokogawa

* Equivalent measurement equipment may be used.

 Please be sure to request delivery specifications that provide further details on the features and specifications of the products for proper and safe use. Please note that the contents may change without any prior notice due to reasons such as upgrading.

MHQ-P_{series} **MHQ1005P Type**

■ ELECTRICAL CHARACTERISTICS

□ CHARACTERISTICS SPECIFICATION TABLE

L (nH)	Tolerance	L measuring frequency (MHz)	Q min.	Q measuring frequency (MHz)	Self-resonant frequency (GHz)		DC resistance (Ω)		Rated current (mA) max.	Part No.
					min.	typ.	max.	typ.		
33	±2%	100	20	250	1.6	2.3	1.50	0.74	220	MHQ1005P33NGT000
33	±3%	100	20	250	1.6	2.3	1.50	0.74	220	MHQ1005P33NHT000
33	±5%	100	20	250	1.6	2.3	1.50	0.74	220	MHQ1005P33NJT000
36	±2%	100	20	250	1.6	2.2	1.50	0.92	190	MHQ1005P36NGT000
36	±3%	100	20	250	1.6	2.2	1.50	0.92	190	MHQ1005P36NHT000
36	±5%	100	20	250	1.6	2.2	1.50	0.92	190	MHQ1005P36NJT000
39	±2%	100	20	250	1.4	2.1	1.50	0.95	190	MHQ1005P39NGT000
39	±3%	100	20	250	1.4	2.1	1.50	0.95	190	MHQ1005P39NHT000
39	±5%	100	20	250	1.4	2.1	1.50	0.95	190	MHQ1005P39NJT000
40	±2%	100	20	250	1.4	2.1	1.50	1.12	190	MHQ1005P40NGT000
40	±3%	100	20	250	1.4	2.1	1.50	1.12	190	MHQ1005P40NHT000
40	±5%	100	20	250	1.4	2.1	1.50	1.12	190	MHQ1005P40NJT000
43	±2%	100	22	250	1.4	2.0	1.60	1.06	190	MHQ1005P43NGT000
43	±3%	100	22	250	1.4	2.0	1.60	1.06	190	MHQ1005P43NHT000
43	±5%	100	22	250	1.4	2.0	1.60	1.06	190	MHQ1005P43NJT000
47	±2%	100	22	250	1.3	1.9	1.60	1.09	190	MHQ1005P47NGT000
47	±3%	100	22	250	1.3	1.9	1.60	1.09	190	MHQ1005P47NHT000
47	±5%	100	22	250	1.3	1.9	1.60	1.09	190	MHQ1005P47NJT000
51	±2%	100	22	250	1.3	1.8	1.80	1.17	190	MHQ1005P51NGT000
51	±3%	100	22	250	1.3	1.8	1.80	1.17	190	MHQ1005P51NHT000
51	±5%	100	22	250	1.3	1.8	1.80	1.17	190	MHQ1005P51NJT000
56	±2%	100	22	250	1.2	1.8	1.80	1.22	180	MHQ1005P56NGT000
56	±3%	100	22	250	1.2	1.8	1.80	1.22	180	MHQ1005P56NHT000
56	±5%	100	22	250	1.2	1.8	1.80	1.22	180	MHQ1005P56NJT000
62	±2%	100	22	250	1.1	1.6	1.90	1.36	180	MHQ1005P62NGT000
62	±3%	100	22	250	1.1	1.6	1.90	1.36	180	MHQ1005P62NHT000
62	±5%	100	22	250	1.1	1.6	1.90	1.36	180	MHQ1005P62NJT000
68	±2%	100	22	250	1.1	1.6	2.00	1.43	160	MHQ1005P68NGT000
68	±3%	100	22	250	1.1	1.6	2.00	1.43	160	MHQ1005P68NHT000
68	±5%	100	22	250	1.1	1.6	2.00	1.43	160	MHQ1005P68NJT000
72	±2%	100	22	250	1.1	1.5	2.20	1.62	160	MHQ1005P72NGT000
72	±3%	100	22	250	1.1	1.5	2.20	1.62	160	MHQ1005P72NHT000
72	±5%	100	22	250	1.1	1.5	2.20	1.62	160	MHQ1005P72NJT000
75	±2%	100	22	250	1.1	1.5	2.20	1.53	160	MHQ1005P75NGT000
75	±3%	100	22	250	1.1	1.5	2.20	1.53	160	MHQ1005P75NHT000
75	±5%	100	22	250	1.1	1.5	2.20	1.53	160	MHQ1005P75NJT000
82	±2%	100	22	250	0.9	1.5	2.30	1.61	160	MHQ1005P82NGT000
82	±3%	100	22	250	0.9	1.5	2.30	1.61	160	MHQ1005P82NHT000
82	±5%	100	22	250	0.9	1.5	2.30	1.61	160	MHQ1005P82NJT000
91	±2%	100	23	250	0.9	1.4	2.30	1.78	160	MHQ1005P91NGT000
91	±3%	100	23	250	0.9	1.4	2.30	1.78	160	MHQ1005P91NHT000
91	±5%	100	23	250	0.9	1.4	2.30	1.78	160	MHQ1005P91NJT000
100	±2%	100	23	250	0.9	1.2	2.50	1.80	150	MHQ1005PR10GT000
100	±3%	100	23	250	0.9	1.2	2.50	1.80	150	MHQ1005PR10HT000
100	±5%	100	23	250	0.9	1.2	2.50	1.80	150	MHQ1005PR10JT000

· Short bar residual inductance =0.556nH

○ Measurement equipment

Measurement item	Product No.	Manufacturer
L, Q	4291B+16193A	Agilent Technologies
Self-resonant frequency	8720C	Agilent Technologies
DC resistance	Type-7561	Yokogawa

* Equivalent measurement equipment may be used.

 Please be sure to request delivery specifications that provide further details on the features and specifications of the products for proper and safe use. Please note that the contents may change without any prior notice due to reasons such as upgrading.

MHQ-P_{series} MHQ1005P Type

■ ELECTRICAL CHARACTERISTICS

□ CHARACTERISTICS SPECIFICATION TABLE

L (nH)	Tolerance	L measuring frequency (MHz)	Q min.	Q measuring frequency (MHz)	Self-resonant frequency (GHz)		DC resistance (Ω)		Rated current (mA) max.	Part No.
					min.	typ.	max.	typ.		
110	±2%	100	22	250	0.8	1.2	2.70	1.98	150	MHQ1005PR11GT000
110	±3%	100	22	250	0.8	1.2	2.70	1.98	150	MHQ1005PR11HT000
110	±5%	100	22	250	0.8	1.2	2.70	1.98	150	MHQ1005PR11JT000
120	±2%	100	22	250	0.8	1.2	2.70	1.81	140	MHQ1005PR12GT000
120	±3%	100	22	250	0.8	1.2	2.70	1.81	140	MHQ1005PR12HT000
120	±5%	100	22	250	0.8	1.2	2.70	1.81	140	MHQ1005PR12JT000
130	±2%	100	22	250	0.8	1.1	2.90	2.18	110	MHQ1005PR13GT000
130	±3%	100	22	250	0.8	1.1	2.90	2.18	110	MHQ1005PR13HT000
130	±5%	100	22	250	0.8	1.1	2.90	2.18	110	MHQ1005PR13JT000
150	±2%	100	22	250	0.8	1.0	3.00	2.03	110	MHQ1005PR15GT000
150	±3%	100	22	250	0.8	1.0	3.00	2.03	110	MHQ1005PR15HT000
150	±5%	100	22	250	0.8	1.0	3.00	2.03	110	MHQ1005PR15JT000

· Short bar residual inductance =0.556nH

○ Measurement equipment

Measurement item	Product No.	Manufacturer
L, Q	4291B+16193A	Agilent Technologies
Self-resonant frequency	8720C	Agilent Technologies
DC resistance	Type-7561	Yokogawa

* Equivalent measurement equipment may be used.

MHQ-P_{series} **MHQ1005P Type**

■ ELECTRICAL CHARACTERISTICS

□ L, Q FREQUENCY CHARACTERISTICS TABLE

L(nH)typ.					Q typ.					Part No.
500MHz	800MHz	1.8GHz	2.0GHz	2.4GHz	500MHz	800MHz	1.8GHz	2.0GHz	2.4GHz	
0.7	0.7	0.7	0.7	0.7	71min.	90min.	139min.	148min.	177min.	MHQ1005P0N7BT000
0.7	0.7	0.7	0.7	0.7	71min.	90min.	139min.	148min.	177min.	MHQ1005P0N7CT000
0.8	0.8	0.8	0.8	0.8	71min.	90min.	139min.	148min.	177min.	MHQ1005P0N8BT000
0.8	0.8	0.8	0.8	0.8	71min.	90min.	139min.	148min.	177min.	MHQ1005P0N8CT000
0.9	0.9	0.9	0.9	0.9	71min.	90min.	139min.	148min.	177min.	MHQ1005P0N9BT000
0.9	0.9	0.9	0.9	0.9	71min.	90min.	139min.	148min.	177min.	MHQ1005P0N9CT000
1.0	1.0	1.0	1.0	1.0	71min.	90min.	139min.	148min.	177min.	MHQ1005P1N0BT000
1.0	1.0	1.0	1.0	1.0	71min.	90min.	139min.	148min.	177min.	MHQ1005P1N0CT000
1.0	1.0	1.0	1.0	1.0	71min.	90min.	139min.	148min.	177min.	MHQ1005P1N0ST000
1.1	1.1	1.1	1.1	1.1	71min.	90min.	139min.	148min.	177min.	MHQ1005P1N1BT000
1.1	1.1	1.1	1.1	1.1	71min.	90min.	139min.	148min.	177min.	MHQ1005P1N1CT000
1.1	1.1	1.1	1.1	1.1	71min.	90min.	139min.	148min.	177min.	MHQ1005P1N1ST000
1.2	1.2	1.2	1.2	1.2	71min.	90min.	139min.	148min.	177min.	MHQ1005P1N2BT000
1.2	1.2	1.2	1.2	1.2	71min.	90min.	139min.	148min.	177min.	MHQ1005P1N2CT000
1.2	1.2	1.2	1.2	1.2	71min.	90min.	139min.	148min.	177min.	MHQ1005P1N2ST000
1.3	1.3	1.3	1.3	1.3	71	90	139	148	178	MHQ1005P1N3BT000
1.3	1.3	1.3	1.3	1.3	71	90	139	148	178	MHQ1005P1N3CT000
1.3	1.3	1.3	1.3	1.3	71	90	139	148	178	MHQ1005P1N3ST000
1.4	1.4	1.4	1.4	1.4	88	103	173	178	203	MHQ1005P1N4BT000
1.4	1.4	1.4	1.4	1.4	88	103	173	178	203	MHQ1005P1N4CT000
1.4	1.4	1.4	1.4	1.4	88	103	173	178	203	MHQ1005P1N4ST000
1.5	1.5	1.5	1.5	1.5	66	76	124	133	151	MHQ1005P1N5BT000
1.5	1.5	1.5	1.5	1.5	66	76	124	133	151	MHQ1005P1N5CT000
1.5	1.5	1.5	1.5	1.5	66	76	124	133	151	MHQ1005P1N5ST000
1.6	1.6	1.6	1.6	1.6	70	88	147	151	171	MHQ1005P1N6BT000
1.6	1.6	1.6	1.6	1.6	70	88	147	151	171	MHQ1005P1N6CT000
1.6	1.6	1.6	1.6	1.6	70	88	147	151	171	MHQ1005P1N6ST000
1.7	1.7	1.7	1.7	1.7	63	80	140	151	179	MHQ1005P1N7BT000
1.7	1.7	1.7	1.7	1.7	63	80	140	151	179	MHQ1005P1N7CT000
1.7	1.7	1.7	1.7	1.7	63	80	140	151	179	MHQ1005P1N7ST000
1.8	1.8	1.8	1.8	1.8	60	75	125	130	150	MHQ1005P1N8BT000
1.8	1.8	1.8	1.8	1.8	60	75	125	130	150	MHQ1005P1N8CT000
1.8	1.8	1.8	1.8	1.8	60	75	125	130	150	MHQ1005P1N8ST000
1.9	1.9	1.9	1.9	1.9	53	68	119	126	150	MHQ1005P1N9BT000
1.9	1.9	1.9	1.9	1.9	53	68	119	126	150	MHQ1005P1N9CT000
1.9	1.9	1.9	1.9	1.9	53	68	119	126	150	MHQ1005P1N9ST000
2.0	2.0	2.0	2.0	2.0	60	74	122	129	146	MHQ1005P2N0BT000
2.0	2.0	2.0	2.0	2.0	60	74	122	129	146	MHQ1005P2N0CT000
2.0	2.0	2.0	2.0	2.0	60	74	122	129	146	MHQ1005P2N0ST000
2.1	2.1	2.1	2.1	2.1	54	70	121	129	152	MHQ1005P2N1BT000
2.1	2.1	2.1	2.1	2.1	54	70	121	129	152	MHQ1005P2N1CT000
2.1	2.1	2.1	2.1	2.1	54	70	121	129	152	MHQ1005P2N1ST000
2.2	2.2	2.2	2.2	2.2	54	68	108	116	131	MHQ1005P2N2BT000
2.2	2.2	2.2	2.2	2.2	54	68	108	116	131	MHQ1005P2N2CT000
2.2	2.2	2.2	2.2	2.2	54	68	108	116	131	MHQ1005P2N2ST000

○ Measurement equipment

Product No.	Manufacturer
4291B+16193A	Agilent Technologies

* Equivalent measurement equipment may be used.

⚠ Please be sure to request delivery specifications that provide further details on the features and specifications of the products for proper and safe use.
Please note that the contents may change without any prior notice due to reasons such as upgrading.

MHQ-P_{series} **MHQ1005P Type**

■ ELECTRICAL CHARACTERISTICS

□ L, Q FREQUENCY CHARACTERISTICS TABLE

L(nH)typ.					Q typ.					Part No.
500MHz	800MHz	1.8GHz	2.0GHz	2.4GHz	500MHz	800MHz	1.8GHz	2.0GHz	2.4GHz	
2.3	2.3	2.3	2.3	2.3	50	64	101	106	119	MHQ1005P2N3BT000
2.3	2.3	2.3	2.3	2.3	50	64	101	106	119	MHQ1005P2N3CT000
2.3	2.3	2.3	2.3	2.3	50	64	101	106	119	MHQ1005P2N3ST000
2.4	2.3	2.4	2.4	2.4	50	64	105	110	125	MHQ1005P2N4BT000
2.4	2.3	2.4	2.4	2.4	50	64	105	110	125	MHQ1005P2N4CT000
2.4	2.3	2.4	2.4	2.4	50	64	105	110	125	MHQ1005P2N4ST000
2.5	2.5	2.5	2.5	2.6	50	65	110	114	135	MHQ1005P2N5BT000
2.5	2.5	2.5	2.5	2.6	50	65	110	114	135	MHQ1005P2N5CT000
2.5	2.5	2.5	2.5	2.6	50	65	110	114	135	MHQ1005P2N5ST000
2.5	2.5	2.6	2.6	2.7	48	65	103	107	122	MHQ1005P2N6BT000
2.5	2.5	2.6	2.6	2.7	48	65	103	107	122	MHQ1005P2N6CT000
2.5	2.5	2.6	2.6	2.7	48	65	103	107	122	MHQ1005P2N6ST000
2.6	2.6	2.7	2.7	2.8	49	61	98	102	116	MHQ1005P2N7BT000
2.6	2.6	2.7	2.7	2.8	49	61	98	102	116	MHQ1005P2N7CT000
2.6	2.6	2.7	2.7	2.8	49	61	98	102	116	MHQ1005P2N7ST000
2.7	2.7	2.8	2.8	2.9	46	58	100	105	123	MHQ1005P2N8BT000
2.7	2.7	2.8	2.8	2.9	46	58	100	105	123	MHQ1005P2N8CT000
2.7	2.7	2.8	2.8	2.9	46	58	100	105	123	MHQ1005P2N8ST000
2.8	2.8	2.9	2.9	3.0	45	58	99	103	120	MHQ1005P2N9BT000
2.8	2.8	2.9	2.9	3.0	45	58	99	103	120	MHQ1005P2N9CT000
2.8	2.8	2.9	2.9	3.0	45	58	99	103	120	MHQ1005P2N9ST000
2.9	2.9	3.0	3.0	3.1	49	62	102	106	120	MHQ1005P3N0BT000
2.9	2.9	3.0	3.0	3.1	49	62	102	106	120	MHQ1005P3N0CT000
2.9	2.9	3.0	3.0	3.1	49	62	102	106	120	MHQ1005P3N0ST000
3.0	3.0	3.1	3.1	3.2	45	58	99	104	121	MHQ1005P3N1BT000
3.0	3.0	3.1	3.1	3.2	45	58	99	104	121	MHQ1005P3N1CT000
3.0	3.0	3.1	3.1	3.2	45	58	99	104	121	MHQ1005P3N1ST000
3.1	3.1	3.2	3.2	3.3	45	58	99	106	121	MHQ1005P3N2BT000
3.1	3.1	3.2	3.2	3.3	45	58	99	106	121	MHQ1005P3N2CT000
3.1	3.1	3.2	3.2	3.3	45	58	99	106	121	MHQ1005P3N2ST000
3.2	3.2	3.3	3.4	3.4	48	60	96	101	115	MHQ1005P3N3BT000
3.2	3.2	3.3	3.4	3.4	48	60	96	101	115	MHQ1005P3N3CT000
3.2	3.2	3.3	3.4	3.4	48	60	96	101	115	MHQ1005P3N3ST000
3.3	3.3	3.4	3.5	3.5	45	57	96	102	118	MHQ1005P3N4BT000
3.3	3.3	3.4	3.5	3.5	45	57	96	102	118	MHQ1005P3N4CT000
3.3	3.3	3.4	3.5	3.5	45	57	96	102	118	MHQ1005P3N4ST000
3.4	3.4	3.5	3.6	3.6	43	57	89	92	104	MHQ1005P3N5BT000
3.4	3.4	3.5	3.6	3.6	43	57	89	92	104	MHQ1005P3N5CT000
3.4	3.4	3.5	3.6	3.6	43	57	89	92	104	MHQ1005P3N5ST000
3.5	3.5	3.6	3.6	3.7	43	56	91	96	110	MHQ1005P3N6BT000
3.5	3.5	3.6	3.6	3.7	43	56	91	96	110	MHQ1005P3N6CT000
3.5	3.5	3.6	3.6	3.7	43	56	91	96	110	MHQ1005P3N6ST000
3.6	3.6	3.7	3.8	3.9	46	57	96	100	114	MHQ1005P3N7BT000
3.6	3.6	3.7	3.8	3.9	46	57	96	100	114	MHQ1005P3N7CT000
3.6	3.6	3.7	3.8	3.9	46	57	96	100	114	MHQ1005P3N7ST000
3.7	3.7	3.9	3.9	4.0	45	59	93	96	109	MHQ1005P3N8BT000
3.7	3.7	3.9	3.9	4.0	45	59	93	96	109	MHQ1005P3N8CT000
3.7	3.7	3.9	3.9	4.0	45	59	93	96	109	MHQ1005P3N8ST000

○ Measurement equipment

Product No.	Manufacturer
4291B+16193A	Agilent Technologies

* Equivalent measurement equipment may be used.

⚠ Please be sure to request delivery specifications that provide further details on the features and specifications of the products for proper and safe use.
Please note that the contents may change without any prior notice due to reasons such as upgrading.

MHQ-P_{series} **MHQ1005P Type**

■ ELECTRICAL CHARACTERISTICS

□ L, Q FREQUENCY CHARACTERISTICS TABLE

L(nH)typ.					Q typ.					Part No.
500MHz	800MHz	1.8GHz	2.0GHz	2.4GHz	500MHz	800MHz	1.8GHz	2.0GHz	2.4GHz	
3.8	3.8	4.0	4.0	4.1	48	61	96	99	111	MHQ1005P3N9BT000
3.8	3.8	4.0	4.0	4.1	48	61	96	99	111	MHQ1005P3N9CT000
3.8	3.8	4.0	4.0	4.1	48	61	96	99	111	MHQ1005P3N9ST000
4.0	4.0	4.2	4.3	4.4	46	59	98	101	115	MHQ1005P4N1BT000
4.0	4.0	4.2	4.3	4.4	46	59	98	101	115	MHQ1005P4N1CT000
4.0	4.0	4.2	4.3	4.4	46	59	98	101	115	MHQ1005P4N1ST000
4.2	4.2	4.4	4.5	4.6	47	60	95	97	107	MHQ1005P4N3BT000
4.2	4.2	4.4	4.5	4.6	47	60	95	97	107	MHQ1005P4N3CT000
4.2	4.2	4.4	4.5	4.6	47	60	95	97	107	MHQ1005P4N3ST000
4.6	4.6	4.8	4.9	5.0	44	56	89	93	102	MHQ1005P4N7BT000
4.6	4.6	4.8	4.9	5.0	44	56	89	93	102	MHQ1005P4N7CT000
4.6	4.6	4.8	4.9	5.0	44	56	89	93	102	MHQ1005P4N7ST000
5.0	5.0	5.2	5.3	5.5	43	55	86	90	99	MHQ1005P5N1BT000
5.0	5.0	5.2	5.3	5.5	43	55	86	90	99	MHQ1005P5N1CT000
5.0	5.0	5.2	5.3	5.5	43	55	86	90	99	MHQ1005P5N1ST000
5.5	5.5	5.8	5.9	6.1	43	54	84	87	94	MHQ1005P5N6BT000
5.5	5.5	5.8	5.9	6.1	43	54	84	87	94	MHQ1005P5N6CT000
5.5	5.5	5.8	5.9	6.1	43	54	84	87	94	MHQ1005P5N6ST000
5.7	5.7	6.1	6.2	6.5	43	57	84	87	94	MHQ1005P5N8BT000
5.7	5.7	6.1	6.2	6.5	43	57	84	87	94	MHQ1005P5N8CT000
5.7	5.7	6.1	6.2	6.5	43	57	84	87	94	MHQ1005P5N8ST000
6.1	6.1	6.6	6.7	7.0	45	57	85	87	93	MHQ1005P6N2BT000
6.1	6.1	6.6	6.7	7.0	45	57	85	87	93	MHQ1005P6N2CT000
6.1	6.1	6.6	6.7	7.0	45	57	85	87	93	MHQ1005P6N2ST000
6.7	6.7	7.3	7.5	7.9	45	58	85	88	92	MHQ1005P6N8BT000
6.7	6.7	7.3	7.5	7.9	45	58	85	88	92	MHQ1005P6N8CT000
6.7	6.7	7.3	7.5	7.9	45	58	85	88	92	MHQ1005P6N8ST000
7.1	7.2	7.7	7.9	8.3	40	52	77	80	84	MHQ1005P7N3GT000
7.1	7.2	7.7	7.9	8.3	40	52	77	80	84	MHQ1005P7N3HT000
7.1	7.2	7.7	7.9	8.3	40	52	77	80	84	MHQ1005P7N3JT000
7.3	7.4	7.9	8.1	8.5	42	54	80	83	88	MHQ1005P7N5GT000
7.3	7.4	7.9	8.1	8.5	42	54	80	83	88	MHQ1005P7N5HT000
7.3	7.4	7.9	8.1	8.5	42	54	80	83	88	MHQ1005P7N5JT000
8.0	8.1	9.0	9.4	10.0	44	56	80	81	82	MHQ1005P8N2GT000
8.0	8.1	9.0	9.4	10.0	44	56	80	81	82	MHQ1005P8N2HT000
8.0	8.1	9.0	9.4	10.0	44	56	80	81	82	MHQ1005P8N2JT000
8.5	8.6	9.6	10.0	10.8	42	52	78	79	80	MHQ1005P8N7GT000
8.5	8.6	9.6	10.0	10.8	42	52	78	79	80	MHQ1005P8N7HT000
8.5	8.6	9.6	10.0	10.8	42	52	78	79	80	MHQ1005P8N7JT000
8.9	9.1	10.1	10.5	11.3	43	54	77	78	79	MHQ1005P9N1GT000
8.9	9.1	10.1	10.5	11.3	43	54	77	78	79	MHQ1005P9N1HT000
8.9	9.1	10.1	10.5	11.3	43	54	77	78	79	MHQ1005P9N1JT000

○ Measurement equipment

Product No.	Manufacturer
4291B+16193A	Agilent Technologies

* Equivalent measurement equipment may be used.

⚠ Please be sure to request delivery specifications that provide further details on the features and specifications of the products for proper and safe use. Please note that the contents may change without any prior notice due to reasons such as upgrading.

MHQ-P_{series} MHQ1005P Type

■ ELECTRICAL CHARACTERISTICS

□ L, Q FREQUENCY CHARACTERISTICS TABLE

L(nH)typ.					Q typ.					Part No.
500MHz	800MHz	1.8GHz	2.0GHz	2.4GHz	500MHz	800MHz	1.8GHz	2.0GHz	2.4GHz	
9.3	9.4	10.6	11.1	12.0	42	54	75	75	75	MHQ1005P9N5GT000
9.3	9.4	10.6	11.1	12.0	42	54	75	75	75	MHQ1005P9N5HT000
9.3	9.4	10.6	11.1	12.0	42	54	75	75	75	MHQ1005P9N5JT000
10	10	11	12	13	42	54	73	74	74	MHQ1005P10NGT000
10	10	11	12	13	42	54	73	74	74	MHQ1005P10NHT000
10	10	11	12	13	42	54	73	74	74	MHQ1005P10NJT000
11	11	13	13	14	41	52	70	70	69	MHQ1005P11NGT000
11	11	13	13	14	41	52	70	70	69	MHQ1005P11NHT000
11	11	13	13	14	41	52	70	70	69	MHQ1005P11NJT000
12	12	14	15	17	40	50	66	65	61	MHQ1005P12NGT000
12	12	14	15	17	40	50	66	65	61	MHQ1005P12NHT000
12	12	14	15	17	40	50	66	65	61	MHQ1005P12NJT000
13	13	16	17	19	42	53	66	66	61	MHQ1005P13NGT000
13	13	16	17	19	42	53	66	66	61	MHQ1005P13NHT000
13	13	16	17	19	42	53	66	66	61	MHQ1005P13NJT000
15	15	19	21	26	39	48	57	54	46	MHQ1005P15NGT000
15	15	19	21	26	39	48	57	54	46	MHQ1005P15NHT000
15	15	19	21	26	39	48	57	54	46	MHQ1005P15NJT000
16	16	20	21	25	34	43	54	52	49	MHQ1005P16NGT000
16	16	20	21	25	34	43	54	52	49	MHQ1005P16NHT000
16	16	20	21	25	34	43	54	52	49	MHQ1005P16NJT000
18	18	23	25	30	39	49	60	57	51	MHQ1005P18NGT000
18	18	23	25	30	39	49	60	57	51	MHQ1005P18NHT000
18	18	23	25	30	39	49	60	57	51	MHQ1005P18NJT000
19	19	25	28	35	39	49	59	55	46	MHQ1005P19NGT000
19	19	25	28	35	39	49	59	55	46	MHQ1005P19NHT000
19	19	25	28	35	39	49	59	55	46	MHQ1005P19NJT000
20	20	26	29	35	38	47	56	53	43	MHQ1005P20NGT000
20	20	26	29	35	38	47	56	53	43	MHQ1005P20NHT000
20	20	26	29	35	38	47	56	53	43	MHQ1005P20NJT000
22	23	31	35	—	34	42	47	43	—	MHQ1005P22NGT000
22	23	31	35	—	34	42	47	43	—	MHQ1005P22NHT000
22	23	31	35	—	34	42	47	43	—	MHQ1005P22NJT000
23	24	33	37	—	41	50	53	48	—	MHQ1005P23NGT000
23	24	33	37	—	41	50	53	48	—	MHQ1005P23NHT000
23	24	33	37	—	41	50	53	48	—	MHQ1005P23NJT000
24	25	35	41	—	39	49	50	44	—	MHQ1005P24NGT000
24	25	35	41	—	39	49	50	44	—	MHQ1005P24NHT000
24	25	35	41	—	39	49	50	44	—	MHQ1005P24NJT000
27	28	42	50	—	37	45	44	37	—	MHQ1005P27NGT000
27	28	42	50	—	37	45	44	37	—	MHQ1005P27NHT000
27	28	42	50	—	37	45	44	37	—	MHQ1005P27NJT000
30	32	55	—	—	33	40	34	—	—	MHQ1005P30NGT000
30	32	55	—	—	33	40	34	—	—	MHQ1005P30NHT000
30	32	55	—	—	33	40	34	—	—	MHQ1005P30NJT000

○ Measurement equipment

Product No.	Manufacturer
4291B+16193A	Agilent Technologies

* Equivalent measurement equipment may be used.

 Please be sure to request delivery specifications that provide further details on the features and specifications of the products for proper and safe use. Please note that the contents may change without any prior notice due to reasons such as upgrading.

MHQ-P_{series} **MHQ1005P Type**

■ ELECTRICAL CHARACTERISTICS

□ L, Q FREQUENCY CHARACTERISTICS TABLE

L(nH)typ.					Q typ.					Part No.
500MHz	800MHz	1.8GHz	2.0GHz	2.4GHz	500MHz	800MHz	1.8GHz	2.0GHz	2.4GHz	
33	35	59	—	—	37	44	37	—	—	MHQ1005P33NGT000
33	35	59	—	—	37	44	37	—	—	MHQ1005P33NHT000
33	35	59	—	—	37	44	37	—	—	MHQ1005P33NJT000
36	39	69	—	—	35	42	32	—	—	MHQ1005P36NGT000
36	39	69	—	—	35	42	32	—	—	MHQ1005P36NHT000
36	39	69	—	—	35	42	32	—	—	MHQ1005P36NJT000
40	43	—	—	—	33	38	—	—	—	MHQ1005P39NGT000
40	43	—	—	—	33	38	—	—	—	MHQ1005P39NHT000
40	43	—	—	—	33	38	—	—	—	MHQ1005P39NJT000
41	44	—	—	—	36	42	—	—	—	MHQ1005P40NGT000
41	44	—	—	—	36	42	—	—	—	MHQ1005P40NHT000
41	44	—	—	—	36	42	—	—	—	MHQ1005P40NJT000
44	47	—	—	—	36	42	—	—	—	MHQ1005P43NGT000
44	47	—	—	—	36	42	—	—	—	MHQ1005P43NHT000
44	47	—	—	—	36	42	—	—	—	MHQ1005P43NJT000
48	53	—	—	—	34	38	—	—	—	MHQ1005P47NGT000
48	53	—	—	—	34	38	—	—	—	MHQ1005P47NHT000
48	53	—	—	—	34	38	—	—	—	MHQ1005P47NJT000
52	58	—	—	—	35	40	—	—	—	MHQ1005P51NGT000
52	58	—	—	—	35	40	—	—	—	MHQ1005P51NHT000
52	58	—	—	—	35	40	—	—	—	MHQ1005P51NJT000
58	65	—	—	—	34	37	—	—	—	MHQ1005P56NGT000
58	65	—	—	—	34	37	—	—	—	MHQ1005P56NHT000
58	65	—	—	—	34	37	—	—	—	MHQ1005P56NJT000
65	74	—	—	—	34	37	—	—	—	MHQ1005P62NGT000
65	74	—	—	—	34	37	—	—	—	MHQ1005P62NHT000
65	74	—	—	—	34	37	—	—	—	MHQ1005P62NJT000
72	82	—	—	—	35	37	—	—	—	MHQ1005P68NGT000
72	82	—	—	—	35	37	—	—	—	MHQ1005P68NHT000
72	82	—	—	—	35	37	—	—	—	MHQ1005P68NJT000
77	90	—	—	—	34	36	—	—	—	MHQ1005P72NGT000
77	90	—	—	—	34	36	—	—	—	MHQ1005P72NHT000
77	90	—	—	—	34	36	—	—	—	MHQ1005P72NJT000
80	93	—	—	—	35	37	—	—	—	MHQ1005P75NGT000
80	93	—	—	—	35	37	—	—	—	MHQ1005P75NHT000
80	93	—	—	—	35	37	—	—	—	MHQ1005P75NJT000
88	107	—	—	—	35	35	—	—	—	MHQ1005P82NGT000
88	107	—	—	—	35	35	—	—	—	MHQ1005P82NHT000
88	107	—	—	—	35	35	—	—	—	MHQ1005P82NJT000
98	121	—	—	—	33	32	—	—	—	MHQ1005P91NGT000
98	121	—	—	—	33	32	—	—	—	MHQ1005P91NHT000
98	121	—	—	—	33	32	—	—	—	MHQ1005P91NJT000
111	143	—	—	—	33	33	—	—	—	MHQ1005PR10GT000
111	143	—	—	—	33	33	—	—	—	MHQ1005PR10HT000
111	143	—	—	—	33	33	—	—	—	MHQ1005PR10JT000

○ Measurement equipment

Product No.	Manufacturer
4291B+16193A	Agilent Technologies

* Equivalent measurement equipment may be used.

⚠ Please be sure to request delivery specifications that provide further details on the features and specifications of the products for proper and safe use.
Please note that the contents may change without any prior notice due to reasons such as upgrading.

MHQ-P_{series} MHQ1005P Type

■ ELECTRICAL CHARACTERISTICS

□ L, Q FREQUENCY CHARACTERISTICS TABLE

L(nH)typ.					Q typ.					Part No.
500MHz	800MHz	1.8GHz	2.0GHz	2.4GHz	500MHz	800MHz	1.8GHz	2.0GHz	2.4GHz	
124	169	—	—	—	31	28	—	—	—	MHQ1005PR11GT000
124	169	—	—	—	31	28	—	—	—	MHQ1005PR11HT000
124	169	—	—	—	31	28	—	—	—	MHQ1005PR11JT000
138	197	—	—	—	30	26	—	—	—	MHQ1005PR12GT000
138	197	—	—	—	30	26	—	—	—	MHQ1005PR12HT000
138	197	—	—	—	30	26	—	—	—	MHQ1005PR12JT000
150	220	—	—	—	31	23	—	—	—	MHQ1005PR13GT000
150	220	—	—	—	31	23	—	—	—	MHQ1005PR13HT000
150	220	—	—	—	31	23	—	—	—	MHQ1005PR13JT000
177	276	—	—	—	30	22	—	—	—	MHQ1005PR15GT000
177	276	—	—	—	30	22	—	—	—	MHQ1005PR15HT000
177	276	—	—	—	30	22	—	—	—	MHQ1005PR15JT000

○ Measurement equipment

Product No.	Manufacturer
4291B+16193A	Agilent Technologies

* Equivalent measurement equipment may be used.

MHQ-P_{series} MHQ1005PType

ELECTRICAL CHARACTERISTICS

L FREQUENCY CHARACTERISTICS GRAPH (EXAMPLE)

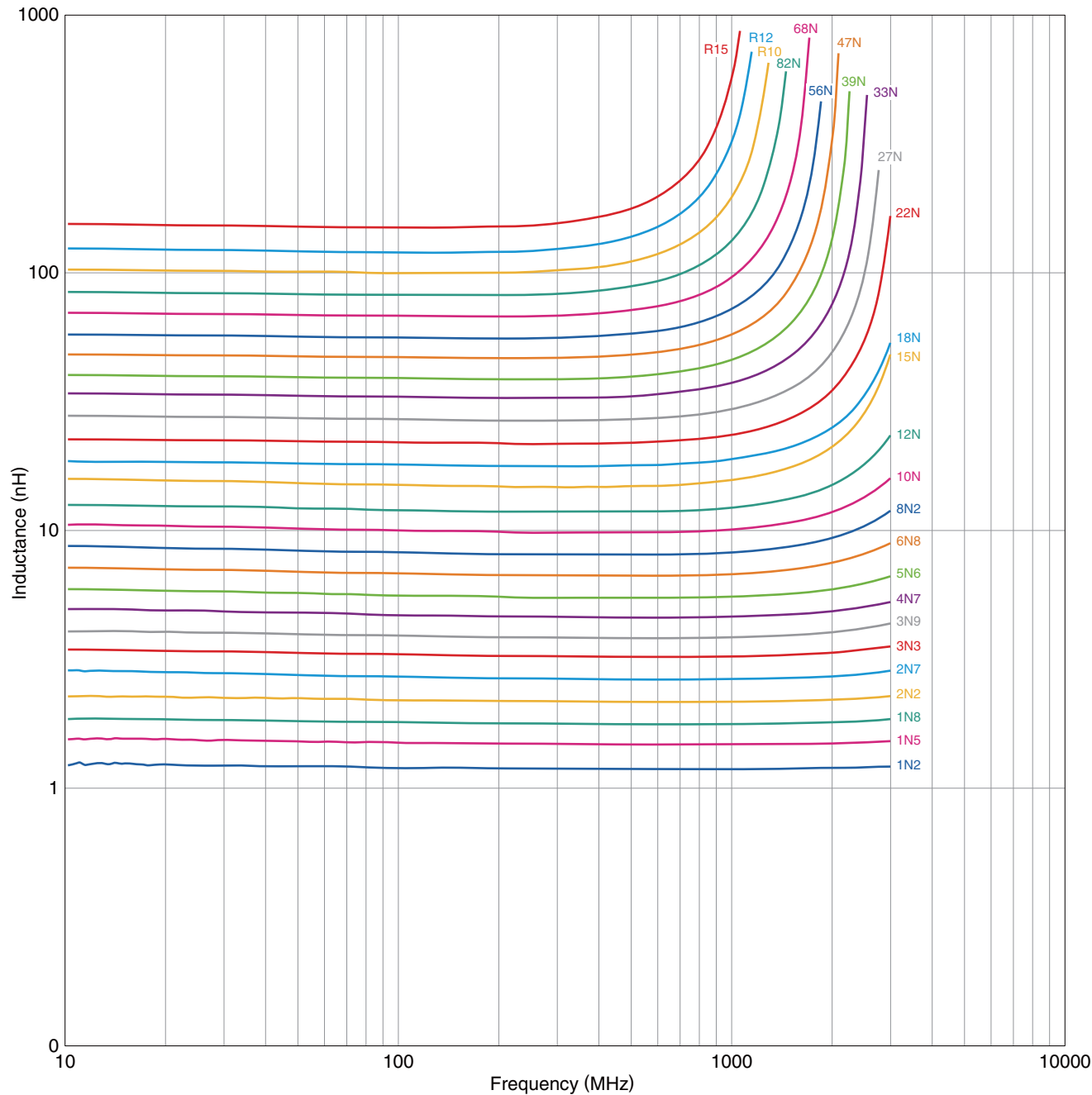

○ Measurement equipment

Product No.	Manufacturer
E4991+16193A	Agilent Technologies

* Equivalent measurement equipment may be used.

 Please be sure to request delivery specifications that provide further details on the features and specifications of the products for proper and safe use. Please note that the contents may change without any prior notice due to reasons such as upgrading.

MHQ-P_{series} MHQ1005P Type

ELECTRICAL CHARACTERISTICS

Q FREQUENCY CHARACTERISTICS GRAPH (EXAMPLE)

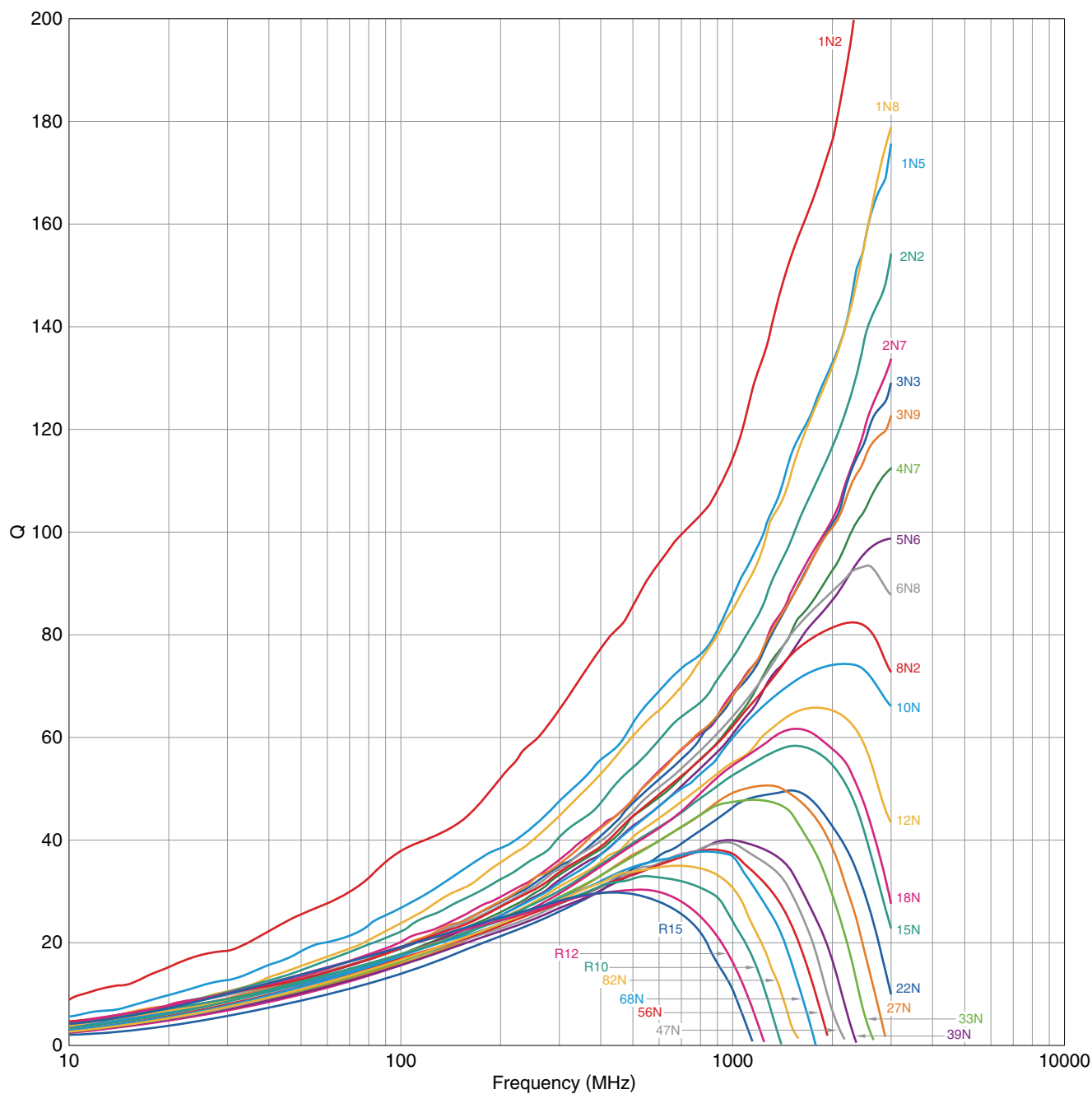

○ Measurement equipment

Product No.	Manufacturer
E4991+16193A	Agilent Technologies

* Equivalent measurement equipment may be used.

 Please be sure to request delivery specifications that provide further details on the features and specifications of the products for proper and safe use. Please note that the contents may change without any prior notice due to reasons such as upgrading.

MHQ-P_{series}

Packaging Style

REEL DIMENSIONS

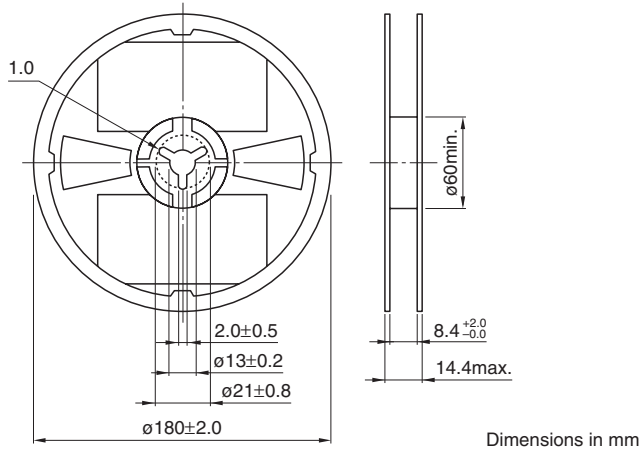

TAPE DIMENSIONS

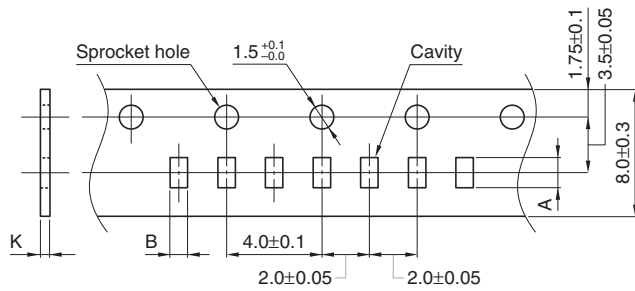

Type	A	B	K
MHQ0402P	0.48±0.02	0.28±0.02	0.40 max.
MHQ0603P	0.74±0.05	0.44±0.05	0.60 max.
MHQ1005P	1.15±0.10	0.75±0.10	0.8 max.

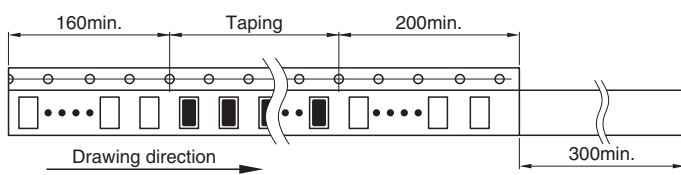

Please be sure to request delivery specifications that provide further details on the features and specifications of the products for proper and safe use. Please note that the contents may change without any prior notice due to reasons such as upgrading.

X-ON Electronics

Largest Supplier of Electrical and Electronic Components

Click to view similar products for [Fixed Inductors](#) category:

Click to view products by [TDK](#) manufacturer:

Other Similar products are found below :

[MLZ1608M6R8WTD25](#) [MLZ1608N6R8LT000](#) [MLZ1608N3R3LTD25](#) [MLZ1608N3R3LT000](#) [MLZ1608N150LT000](#)
[MLZ1608M150WTD25](#) [MLZ1608M3R3WTD25](#) [MLZ1608M3R3WT000](#) [MLZ1608M150WT000](#) [MLZ1608A1R5WT000](#)
[MLZ1608N1R5LT000](#) [B82432C1333K000](#) [PCMB053T-1R0MS](#) [PCMB053T-1R5MS](#) [PCMB104T-1R5MS](#) [CR32NP-100KC](#) [CR32NP-151KC](#) [CR32NP-180KC](#) [CR32NP-181KC](#) [CR32NP-1R5MC](#) [CR32NP-390KC](#) [CR32NP-3R9MC](#) [CR32NP-680KC](#) [CR32NP-820KC](#)
[CR32NP-8R2MC](#) [CR43NP-390KC](#) [CR43NP-560KC](#) [CR43NP-680KC](#) [CR54NP-181KC](#) [CR54NP-470LC](#) [CR54NP-820KC](#) [CR54NP-8R5MC](#)
[MGDQ4-00004-P](#) [MGDU1-00016-P](#) [MHL1ECTTP18NJ](#) [MHL1JCTTD12NJ](#) [PE-51506NL](#) [PE-53601NL](#) [PE-53630NL](#) [PE-53824SNLT](#) [PE-62892NL](#) [PE-92100NL](#) [PG0434.801NLT](#) [PG0936.113NLT](#) [PM06-2N7](#) [PM06-39NJ](#) [HC2LP-R47-R](#) [HC2-R47-R](#) [HC3-2R2-R](#) [HC8-1R2-R](#)