

# MH - MODULAR SERIES

## Features:

- UL94V-0 polycarbonate body
- True knife blade, insulating piercing contacts
- Compatible with standard crimping tools
- Compatible with all FCC specifications
- Flat cable Plug available on request
- 50 $\mu$ " gold plated contacts as standard. Other platings on request. (6, 15 & 30 $\mu$ " )

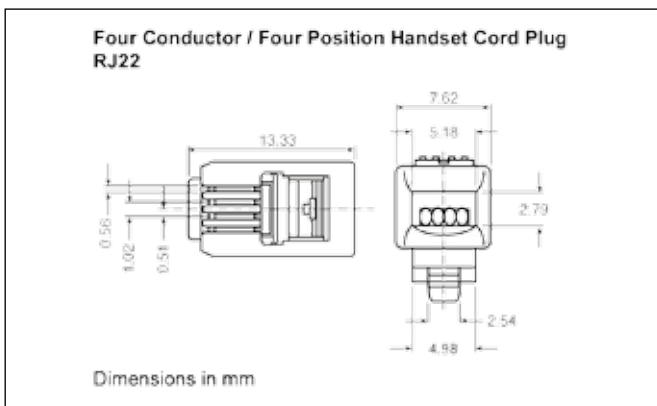
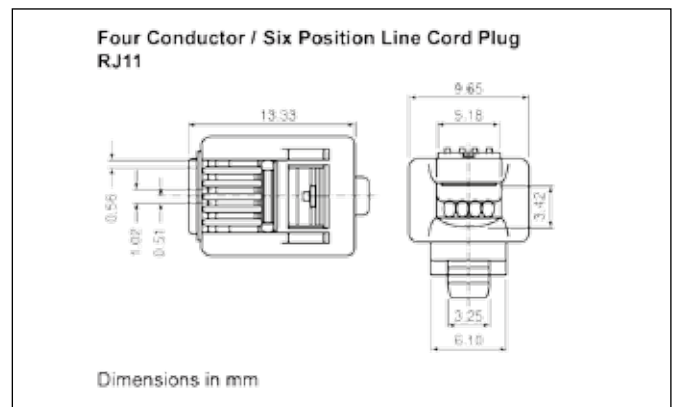
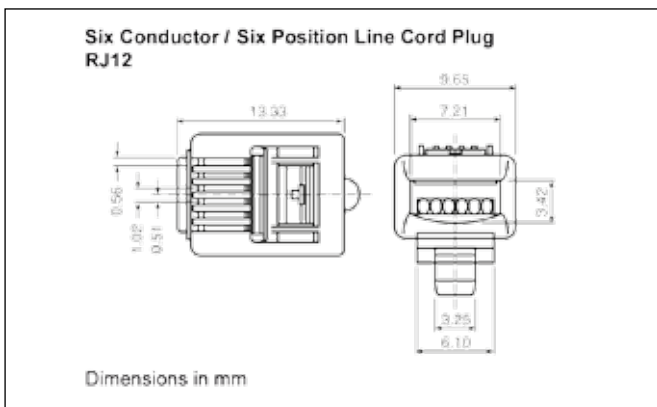
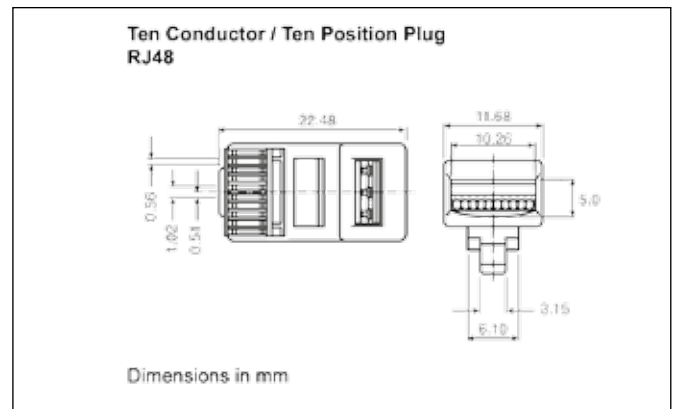
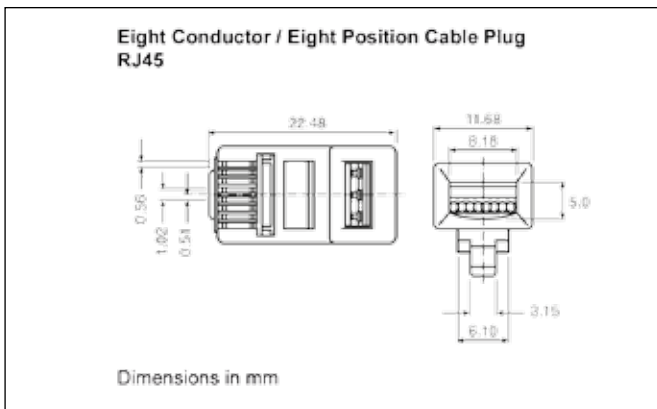
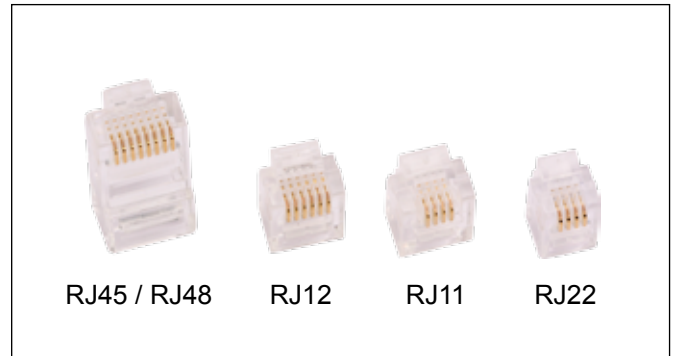

## Ordering information:

Size:	P/N - BULK:	Product Code:
8P8C	6510-0104-01	MHRJ45-8P8CR
4P4C	6510-0104-02	MHRJ22-4P4CR
6P4C	6510-0104-03	MHRJ11-6P4CR
6P6C	6510-0104-04	MHRJ12-6P6CR
10P10C	6510-0104-05	MHRJ48-10P10CR

## MH - MODULAR SERIES

### MHRJ45SRB - Series



#### Features:

- Standard version OD up to 6.0 mm
- Small version OD up to 4.3 mm
- Available in 11 standard colours
- Custom colours available upon request.

#### Ordering information:

Standard 6.0 mm

Colour:	P/N - BULK:	Product Code:
Light Grey	6510-0100-01	MHRJ45SRB-LG
Dark Grey	6510-0100-02	MHRJ45SRB-DG
Blue	6510-0100-03	MHRJ45SRB-B
Yellow	6510-0100-04	MHRJ45SRB-Y
Green	6510-0100-05	MHRJ45SRB-G
Black	6510-0100-06	MHRJ45SRB-BK
Purple	6510-0100-07	MHRJ45SRB-P
White	6510-0100-08	MHRJ45SRB-W
Orange	6510-0100-09	MHRJ45SRB-O
Red	6510-0100-10	MHRJ45SRB-R
Pink	6510-0100-11	MHRJ45SRB-PK

For Small version, 4.3 mm: 6510-0101-xx / MHRJ45SRB-SM-xx

### MHRJ45SRB - Translucent Series

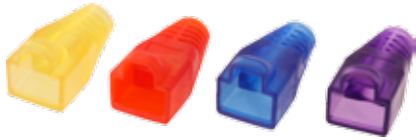

#### Features:

- Standard version OD up to 6.0 mm
- Available in 6 standard colours
- Custom colours available upon request.

#### Ordering information:

Standard 6.0 mm

Colour:	P/N - BULK:	Product Code:
Blue	6510-0100-21	MHRJ45SRB-TRANS-B
Yellow	6510-0100-22	MHRJ45SRB-TRANS-Y
Green	6510-0100-23	MHRJ45SRB-TRANS-G
Purple	6510-0100-24	MHRJ45SRB-TRANS-P
Orange	6510-0100-25	MHRJ45SRB-TRANS-O
Red	6510-0100-26	MHRJ45SRB-TRANS-R

### MHRJ45SRB - Retrofit Series



#### Features:

- Retrofit style for provision of strain relief / Colour Coding after Cable Assembly has been made. (On Site Coding)

#### Ordering information:

Colour:	P/N - BULK:	Product Code:
Light Grey	6510-0102-01	MHRJ45SRB-RET-LG
Dark Grey	6510-0102-02	MHRJ45SRB-RET-DG
Blue	6510-0102-03	MHRJ45SRB-RET-B
Yellow	6510-0102-04	MHRJ45SRB-RET-Y
Green	6510-0102-05	MHRJ45SRB-RET-G
Black	6510-0102-06	MHRJ45SRB-RET-BK
Purple	6510-0102-07	MHRJ45SRB-RET-P
White	6510-0102-08	MHRJ45SRB-RET-W
Orange	6510-0102-09	MHRJ45SRB-RET-O
Red	6510-0102-10	MHRJ45SRB-RET-R

# MH - MODULAR SERIES

## MHRJ45-SC - Shielding Can

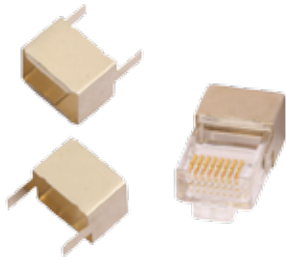

### Ordering information:

Type:	P/N - BULK:	Product Code:
RJ45-SC	6510-0103-01	MHRJ45SC-GS

### Features:

- Shielding Can for easy conversion from UTP to FTP
- Recommended for use with MHRJ45-8P8CR and any of the MHRJ45-SRB boots

Figure 1.

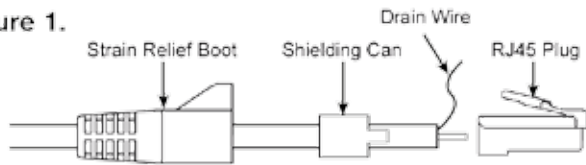

Prepare cable as you would for UTP assemblies. Place the boot onto the cable, followed by the metal can, as shown above.

Figure 2.

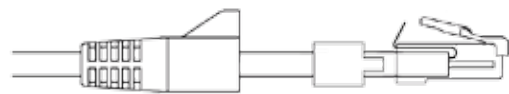

Terminate the RJ45 plug prior to fitting the shielding can. Bend the drain wire across the top of the RJ45 body as shown, trim if necessary.

## MHRJ45-SRI - Series



### Ordering information:

Colour:	P/N - BULK:	Product Code:
Light Grey	6510-0109-01	MHRJ45SRI-LG
Dark Grey	6510-0109-02	MHRJ45SRI-DG
Blue	6510-0109-03	MHRJ45SRI-B
Yellow	6510-0109-04	MHRJ45SRI-Y
Green	6510-0109-05	MHRJ45SRI-G
Black	6510-0109-06	MHRJ45SRI-BK
Red	6510-0109-10	MHRJ45SRI-R

### Features:

- Standard version OD up to 6.0 mm
- Insert locks into place after crimp
- Available in 7 standard colours
- Custom colours available upon request
- Recommended for use with MHRJ45-8P8CR plug

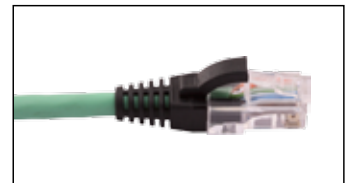

## X-ON Electronics

Largest Supplier of Electrical and Electronic Components

*Click to view similar products for [Modular Connectors / Ethernet Connectors](#) category:*

*Click to view products by [MH Connectors](#) manufacturer:*

Other Similar products are found below :

[RJE231881317T](#) [MP1010RX-1000](#) [MP44RX-1000](#) [GAX-3-66](#) [GAX-8-62](#) [93606-0253](#) [GD-A-44](#) [GDCX-PA-66-50](#) [GDCX-PN-64](#) [GDCX-PN-66](#) [GDCX-PN-66-50](#) [GDLX-A-66](#) [GDLX-A-88](#) [GDLX-N-66](#) [GDLX-S-88K](#) [GDTX-S-88-50](#) [GDX-PA-1010](#) [GLX-N-1010M-BLK](#) [GLX-N-44M](#) [GLX-S-88M-BLK](#) [GMX-N-1010](#) [GMX-S-1010](#) [GMX-S-66](#) [GMX-SMT2-N-1010](#) [GMX-SMT2-N-64-50](#) [GMX-SMT2-S6-88](#) [GMX-SMT4-N-88](#) [GPX-2-64](#) [GRT1-BT1-5](#) [GSGX-N-2-88](#) [GSX-NS2-88-3.05](#) [GSX-NS2-88-3.05-50](#) [GSX-NS-88-3.05-30](#) [GSX-NS-88-3.05-50](#) [GSX-NS-88-3.68](#) [1-1775629-2](#) [GWLX-S-88-GR](#) [GWLX-S9-88-YG](#) [1300500326](#) [1300500227](#) [1300530003](#) [1300570002](#) [1324640-4](#) [RJ11FTVC2G](#) [RJ11FTVC2N](#) [RJFTVX2SA1G](#) [132764-001](#) [1400000](#) [1413176](#) [1413235](#)