

PRODUCT NUMBER 10075024-XXX-XXXLF

- LEAD FREE
 - RoHS COMPATIBLE
 - NOTE 6
 - NOTE 5
 - PACKAGING
 - POSITIONS PER ROW 02 TO 25
 - SEE NOTE 9
 - PIN STYLE DIM "A"
 - 01 4.00
 - 02 6.90
- S = 0.38µm GOLD ON CONTACT AREA
 G = 0.76µm GOLD ON CONTACT AREA
 2µm MIN MATTE TIN ON TAIL
 F = GOLD FLASH ON CONTACT AREA
 2µm MIN MATTE TIN ON TAIL
 1.27µm MIN NICKEL UNDERPLATING

NOTES:
 1. MATERIAL HOUSING: HIGH TEMP. THERMOPLASTIC UL 94V-0, COLOR BLACK
 2. MATERIAL TERMINAL: COPPER ALLOY
 3. TO DETERMINE DIMENSIONS:
 N = NUMBER OF POSITIONS PER ROW
 4. 7N MIN. PIN RETENTION IN EITHER DIRECTION.
 5. PACKAGING:
 = STANDARD PACKAGING IN POLYBAG
 U = TUBE WITHOUT PICK UP CAP
 AVAILABLE FROM 03 TO 25 POS PER ROW
 P = TUBE WITH PICK UP CAP
 AVAILABLE FROM 03 TO 25 POS PER ROW
 A = TAPE AND REEL WITH PICK UP CAP INSTALLED
 IN THE CENTER OF THE PRODUCT FOR PICK AND PLACE
 SEE TA 884 FOR PRODUCT AVAILABILITY.

6. RoHS COMPATIBLE PRODUCT SPECIFICATIONS
 a - PLATING:
 - "LF" MEANS THE PRODUCT IS LEAD-FREE,
 2µm MINIMUM MATTE TIN OVER 1.27µm
 MINIMUM NICKEL UNDERPLATE.
 b - MANUFACTURING PROCESS COMPATIBILITY
 - THE HOUSING WILL WITHSTAND EXPOSURE TO
 260°C PEAK TEMPERATURE FOR 30 SECONDS MAX
 IN A CONVECTION, INFRA-RED, OR VAPOR PHASE
 OR REFLOW OVEN
 c - LABELLING:
 - MEETS PACKAGING SPECS AS PER GS-14-920
 d - LEGAL STATEMENT: SEE GS-47-0004

9. OPTIONAL LETTER:
 FOR FULL LOADED PRODUCT USE -
 FOR POLARIZED VERSIONS, SEE TABLE

OPTIONAL LETTER FOR MISSING PIN POSITION	A
POLARIZED VERSION	20

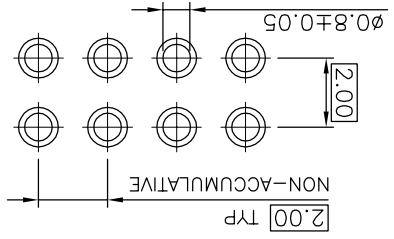

RECOMMENDED 1.6mm THICK PCB LAYOUT

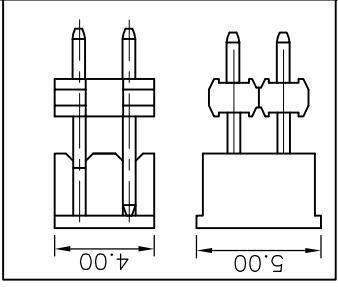
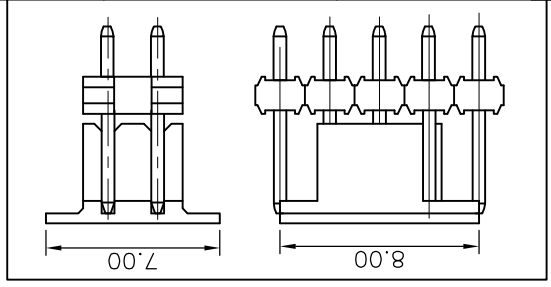
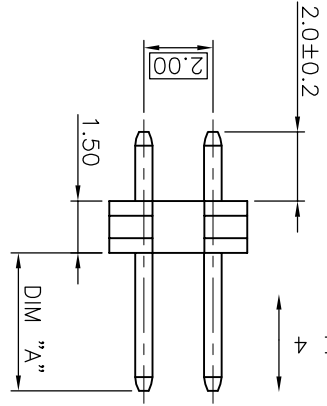
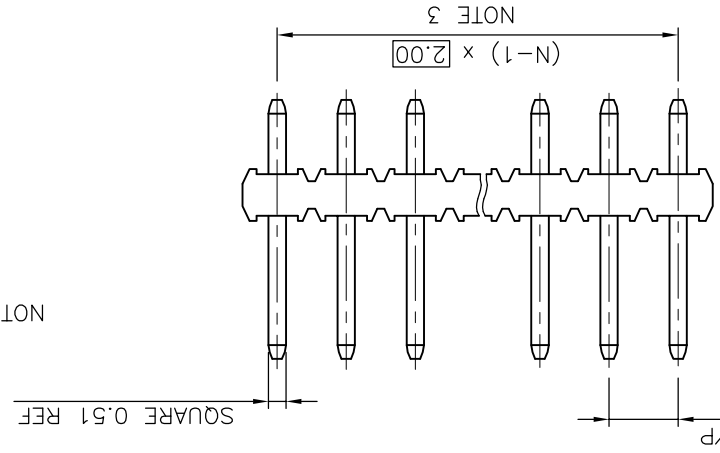
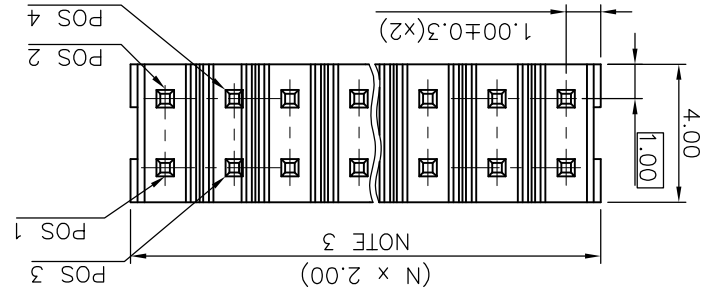

product name MINITEK
 CARTRIDGES FOR TUBE

title UNSHR.HEADER
 2.00 mm VERTICAL PIP
 dwg no sheet 1 of 1 size A3

type CUSTOMER Drawing

lfr ecn no	dr	date	tolerances unless otherwise specified
H B-19797	AMA	14.12.16	
C F08-0145	ELA	08.05.19	
D F08-0226	LMU	08.09.22	dr
E B-17331	LMU	14.03.28	engr
F B-17566	JCO	14.04.23	chr
G B-19190	LMU	14.10.24	qppd
J.M.C		07.01.04	



scale 5:1
 mm

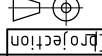

index sheet	revision

X-ON Electronics

Largest Supplier of Electrical and Electronic Components

Click to view similar products for [Headers & Wire Housings](#) category:

Click to view products by [FCT Electronics](#) manufacturer:

Other Similar products are found below :

[95000-104TRLF](#) [10135584-644402LF](#) [DF62W-EP2022PCA](#) [95000-106TRLF](#) [DF62W-2022SCA](#) [DF62W-EP2022PC](#) [2203348](#) [DF62W-2022SC](#) [1084018](#) [1029039](#) [1084017](#) [802-10-012-10-002000](#) [1112640](#) [1112639](#) [891-007-9SS-BST1T](#) [000-34000](#) [0008550134](#) [0009482033](#) [0009507031](#) [57102-F02-18ULF](#) [57102-S06-03LF](#) [57202-S52-04LF](#) [PCN6-15S-2.5E](#) [0039019024](#) [58102-G61-06LF](#) [582553-1](#) [0009485154](#) [0009508121](#) [0022285053](#) [0050291907](#) [018731A](#) [LY20-4P-DT1-P1E-BR](#) [02.125.8002.8](#) [60101931](#) [60598-1 \(Cut Strip\)](#) [M1625-3R/100](#) [61062-3](#) [61082-181009](#) [CSU011177004](#) [636-1427](#) [638009-1](#) [641938-9](#) [641991-4](#) [644168-1](#) [644827-2](#) [647662-1](#) [65039-019ELF](#) [65692-001LF](#) [65781-018](#) [65781-047](#)