

NUMBER <b>GS-12-350</b>	TYPE <b>Product Specification</b>		
TITLE <b>HIGH DENSITY D-SUBMINIATURE CONNECTORS</b>		PAGE 1 of 11	REVISION A
		AUTHORIZED BY Jason Hsu	DATE 12/10/2009
CLASSIFICATION <b>CONFIDENTIAL</b>			

### 1.0 OBJECTIVE

This specification defines the performance, test quality, and reliability requirements of the Hi-Density D-Subminiature connector products.

### 2.0 SCOPE

This specification is applicable to the termination characteristics of the Hi-Density D-Subminiature connector products designed for use in digital computer system.

### 3.0 GENERAL

This document is composed of the following sections:

<u>Paragraph</u>	<u>Title</u>	<u>Pages</u>
1.0	Objective	1
2.0	Scope	1
3.0	General	1
4.0	Applicable Document	1
5.0	Requirements	2
5.1	Qualification	2
5.2	Material	2
5.3	Finish	3
5.4	Design and Construction	3
6.0	Electrical Characteristics	4
7.0	Mechanical Characteristics	6
8.0	Environmental Conditions	7
9.0	Quality Assurance Provisions	8
9.1	Equipment Calibration	8
9.2	Inspection Conditions	8
9.3	Sample Quantity and Description	9
9.4	Acceptance	10
9.5	Re-qualification Testing	10
9.6	Qualification Testing	10
Table III	Qualification Testing Matrix	11

### 4.0 APPLICABLE DOCUMENTS

#### 4.1 Specifications

4.1.1 Engineering drawings

#### 4.2 Military Standards / Specification

4.2.1 MIL-STD-202G: Test methods for electronic and electrical component parts.

4.2.2 MIL-C-45662 : Calibration system requirement.

#### 4.3 Other Standard and Specification

4.4.1 UL94 : Test flammability of plastic materials.

This document is the property of and embodies CONFIDENTIAL and PROPRIETARY information of FCI. No part of the information shown on the document may be used in any way or disclosed to others without the written consent of FCI. Copyright FCI.

NUMBER <b>GS-12-350</b>	TYPE <b>Product Specification</b>		
TITLE HIGH DENSITY D-SUBMINIATURE CONNECTORS		PAGE 2 of 11	REVISION A
		AUTHORIZED BY Jason Hsu	DATE 12/10/2009
CLASSIFICATION <b>CONFIDENTIAL</b>			

- 4.4.2 JIS-H3100 : Brass strip
- 4.4.3 JIS G3141 : Steel, sheet, and strip, SPCC.
- 4.4.4 IEC 512-7 Test 13b : Insertion / withdrawl force measurement.
- 4.4.5 IEC 512-3 Test 5b: Current rating test.

## 5.0 REQUIREMENTS

- 5.1 Qualification  
Connectors furnished under this specification shall be capable of meeting the qualification test requirements specified herein.
- 5.2 Material  
The material for each component shall be as specified herein or equivalent.
  - 5.2.1 Female Contact: Female contact shall be brass alloy in accordance with JIS-H3100, C2600R.
  - 5.2.2 Male Contact: Male contact shall be brass alloy in accordance with JIS-H3100, C2600R.
  - 5.2.3 Plastic parts: All molded plastic parts shall be filled polyester, flame retardant UL 94V-0, color black.
  - 5.2.4 Metal Shell: The Metal shell shall be SPCC strip in accordance with JIS G3141.
  - 5.2.5 Hex. Screwlocks and ground clips : Copper alloy C2600 in accordance with JIS-H3100.
- 5.3 Finish  
The finish for applicable components shall be as specified in the applicable product drawing.
- 5.4 Design and Construction  
Connectors shall be of the design, construction, and physical dimension specified in the applicable product drawing.
  - 5.4.1 Mating: The connector shall be capable of mating and unmating by hand without the use of special tools with specified temperature range.
  - 5.4.2 Workmanship: Connectors shall be uniform in quality and shall be free from burrs, scratches, cracks, voids, chips, blisters, pin holes, sharp, edges and other defects that will adversely affect life or serviceability.
  - 5.4.3 Interchangeability : Individual plugs and sockets shall be capable of mating with any appropriately constituted female or male standard D-subminiature connector of the same population without degradation in performance.

## 6.0 ELECTRICAL CHARACTERISTICS

- 6.1 Contact Resistance , Low Level (LLCR) - The low level contact resistance shall not exceed 15 milliohms after environmental exposure when measured in accordance with MIL-STD-202G, Method 3002.1. The following degradation in performance.
  - a.  $R_c \leq 15m\Omega$  for straight,  $R_c \leq 30m\Omega$  after tests.  
 $R_c \leq 25m\Omega$  for right angle,  $R_c \leq 40m\Omega$  after tests.  
 $R_c \leq 35m\Omega$  for right angle 78 cts,  $R_c \leq 50m\Omega$  after tests.
  - b. Method of Connection - attach current and voltage leads as shown in figure 1.

This document is the property of and embodies CONFIDENTIAL and PROPRIETARY information of FCI. No part of the information shown on the document may be used in any way or disclosed to others without the written consent of FCI. Copyright FCI.

NUMBER <b>GS-12-350</b>	TYPE <b>Product Specification</b>		
TITLE <b>HIGH DENSITY D-SUBMINIATURE CONNECTORS</b>		PAGE 3 of 11	REVISION A
		AUTHORIZED BY Jason Hsu	DATE 12/10/2009
CLASSIFICATION <b>CONFIDENTIAL</b>			

- c. Test Voltage : 20 millivolts DC maximum open circuit.
- d. Test Current : Not to exceed 100 milliamperes.

- 6.2 Insulation Resistance - The insulation resistance of unmated connectors shall be not less than 5,000 megohms (1,000 megohms after environmental exposure) when measured in accordance with MIL-STD-202G, Method 302. The following details shall apply:
- a. Test Voltage: 500 volts DC.
  - b. Electrification Time: 2 minutes.
  - c. Point of Measurement : Between adjacent contacts.
- 6.3 Dielectric Withstanding Voltage- There shall be no evidence of arc over, insulation breakdown, or excessive leakage current ( 1 milliampere) when the unmated connectors are tested in accordance with MIL-STD-202G, Method 302. The following detail shall apply:
- a. Test Voltage: 750 volts RMS, 60 Hz.
  - b. Test Duration: 60 seconds.
  - c. Test Condition: Local ambient.
- 6.4 Current Rating - The temperature rise above ambient shall not exceed 30°C at any point in system when all contacts are powered at 2.5 amperes. Or the connectors must be able to pass 3A permanently loaded all contacts at 70°C with a max temp of the connector of 125°C.

The following details shall apply with IEC 512-3 test 5a.

NUMBER <b>GS-12-350</b>	TYPE <b>Product Specification</b>	<b>FCI</b>	
TITLE <b>HIGH DENSITY D-SUBMINIATURE CONNECTORS</b>		PAGE 4 of 11	REVISION A
		AUTHORIZED BY Jason Hsu	DATE 12/10/2009
CLASSIFICATION <b>CONFIDENTIAL</b>			

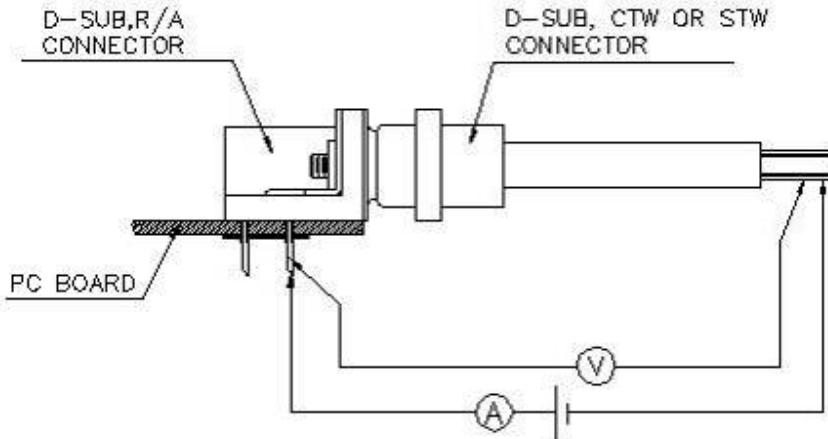

RIGHT ANGLE TYPE

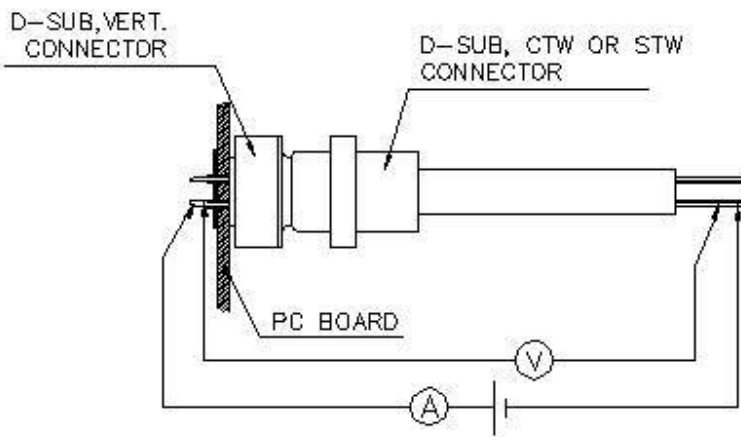

VERTICAL TYPE

FIGURE 1, CONTACT RESISTANCE MEASUREMENT

This document is the property of and embodies CONFIDENTIAL and PROPRIETARY information of FCI. No part of the information shown on the document may be used in any way or disclosed to others without the written consent of FCI. Copyright FCI.

NUMBER <b>GS-12-350</b>	TYPE <b>Product Specification</b>	<b>FCI</b>	
TITLE <b>HIGH DENSITY D-SUBMINIATURE CONNECTORS</b>		PAGE 5 of 11	REVISION A
		AUTHORIZED BY Jason Hsu	DATE 12/10/2009
CLASSIFICATION <b>CONFIDENTIAL</b>			

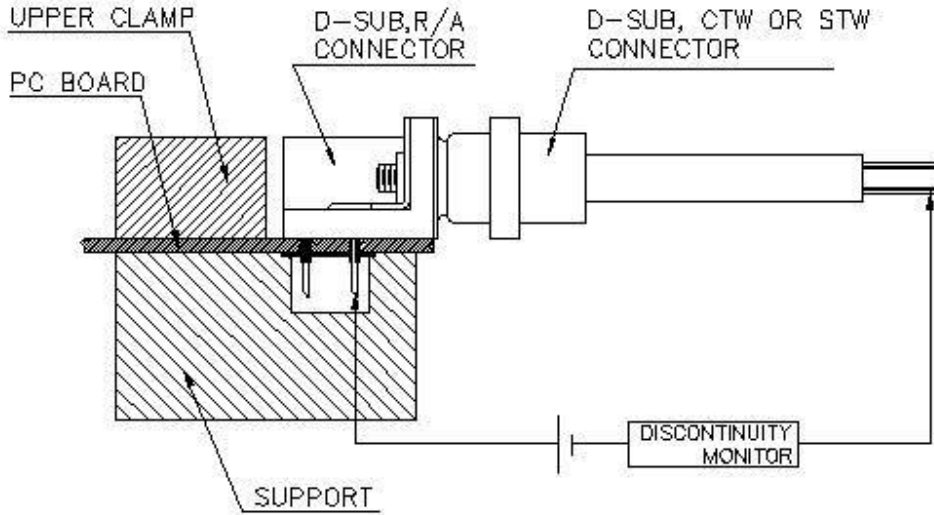

RIGHT ANGLE TYPE

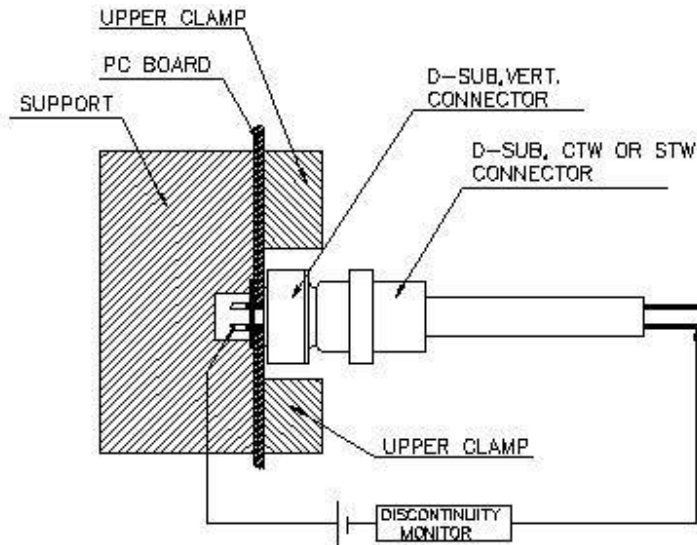

VERTICAL TYPE

FIGURE 2, VIBRATION AND PHYSICAL SHOCK MOUNTING FIXTURE

This document is the property of and embodies CONFIDENTIAL and PROPRIETARY information of FCI. No part of the information shown on the document may be used in any way or disclosed to others without the written consent of FCI. Copyright FCI.

NUMBER <b>GS-12-350</b>	TYPE <b>Product Specification</b>		
TITLE HIGH DENSITY D-SUBMINIATURE CONNECTORS		PAGE 6 of 11	REVISION A
		AUTHORIZED BY Jason Hsu	DATE 12/10/2009
CLASSIFICATION <b>CONFIDENTIAL</b>			

## 7.0 MECHANICAL CHARACTERISTICS

- 7.1 Total mating/unmating force - The total force to mate the male plug and female receptacle (or use VESA) shall not exceed the values shown in Table I. The total unmating force shall not be less than the values shown in Table 1. The test shall be in accordance with EIA-364, TP-13B. Following details shall apply:
- Cross Head Speed: 25.4 mm per minute.
  - Lubrication: no.
  - Utilize free-floating fixtures.

Table 1 - Total Insertion / Withdrawal forces

Pins	Insertion force		Withdrawal force	
	Max. N	Min. N	Min. N	Max. N
15	37.4	3.3	3.3	30
26	58.4	4.5	4.5	50
44	90.8	7.8	7.8	83
62	132	11	11	123
78	176	14.5	14.5	167

- 7.2 Individual Contact insertion / withdraw force - The insertion force shall not exceed 5N when a maximum gage is inserted. After three insertions with a maximum gage. The withdraw force shall not be less than 0.2N when measured using a minimum gauge. See Figure 3. for gages description. Gages shall not be lubricated. The gage pins will be set to insert into the female connector.25" depth far away from the mating top surface. Testing shall be in accordance with IEC 512-7 Test 13b

Figure 3 ,Contact Insertion / Withdrawal gages

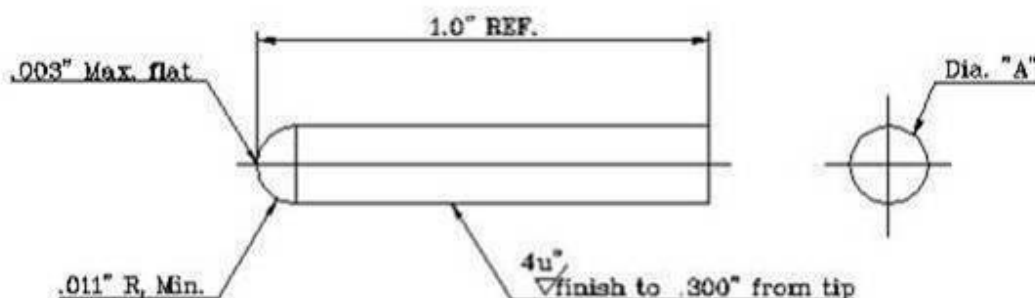

Gages	Dia. "A"
Max. gage	.0310" +.0002/-0
Min. gage	.0290"+0/-0.0002

This document is the property of and embodies CONFIDENTIAL and PROPRIETARY information of FCI. No part of the information shown on the document may be used in any way or disclosed to others without the written consent of FCI. Copyright FCI.

NUMBER <b>GS-12-350</b>	TYPE <b>Product Specification</b>		
TITLE <b>HIGH DENSITY D-SUBMINIATURE CONNECTORS</b>		PAGE 7 of 11	REVISION A
		AUTHORIZED BY Jason Hsu	DATE 12/10/2009
		CLASSIFICATION <b>CONFIDENTIAL</b>	

7.3 Total Board latch retention / insertion force (for Grounding Cilp version only):

7.3.1 Board latch retention / insertion force shall be checked on an .062 inch hick segment of FR-4 glass / epoxy circuit board segment with a hole of diameter as described below drilled through. It is preferable to check housings without terminals installed or terminals that would interfere with measurement shall be removed.

7.3.2 Total Max. insertion force is not higher than 60 newtons while seat the connector into the .117 inch diameter size PCB holes.

7.3.3 Total latch retention force is not less 10 newtons while seat the connector into the .123 inch diameter size PCB holes.

7.4 Torque of Hex. Screwlocks: Both hex. - standoffs should be withstood 0.5N-m torque Min. after fastening and won't be loose.

7.5 Contact retention force (crimping type): No displacement of contact from insulator to be observed when an axial load of 30N applied to each contact of crimp termination connectors.

## 8.0 ENVIRONMENTAL CONDITION

After exposure to the following environmental conditions in accordance with the specified test procedure and or details product shall show no physical damage and shall meet the electrical and mechanical requirements per paragraphs 6.0 and 7.0 as specified in Table III test sequences. Unless specified otherwise, assemblies shall be mated during exposure.

8.1 Thermal Shock - MIL-STD-202G, Method 107G  
(a) Test Condition : A (5, 1 hour cycles )  
(b) Temperature Range : between -55 and +85°C  
(c) Time at Each Temperature: 30 minutes.  
(d) Transfer time: 5 minutes, Max.

8.2 Humidity Steady State - MIL-STD-202G, Method 103B  
(a) Relative Humidity : 95%  
(b) Temperature : +40 °C  
(c) Test Condition : 48 hours

8.3 High Temperature Life - MIL-STD-202G, Method 108A  
(a) Test Temperature : 105°C  
(b) Test Duration : 500 hours

8.4 Salt Spray - MIL-STD-202G, Method 101D  
(a) Salt Solution : 5% by weight  
(b) Test Condition : 24 hours

8.5 Vibration - MIL-STD-202G, Method 204D  
(a) Condition : B  
(b) Vibration Amplitude : 0.06" DA or 10G(peak)  
(c) Frequency Range : 10 to 500 HZ.  
(d) Sweep Time and Duration : 20 minutes per sweep 3 hours along each of three orthogonal axes (9 hours total)

This document is the property of and embodies CONFIDENTIAL and PROPRIETARY information of FCI. No part of the information shown on the document may be used in any way or disclosed to others without the written consent of FCI. Copyright FCI.

NUMBER <b>GS-12-350</b>	TYPE <b>Product Specification</b>		
TITLE <b>HIGH DENSITY D-SUBMINIATURE CONNECTORS</b>		PAGE 8 of 11	REVISION A
		AUTHORIZED BY Jason Hsu	DATE 12/10/2009
CLASSIFICATION <b>CONFIDENTIAL</b>			

- (e) Mounting: rigidly mount assemblies as shown in figure 2.
- (f) No discontinuities greater than 1 microsecond

8.6 Mechanical Shock - MIL-STD-202G, Method 213B

- (a) Condition : B (50G, 6 millisecond half-sine)
- (b) Shocks : 3 shocks in both directions along each of three orthogonal axes (18 total)
- (c) Mounting : Rigid mount assemblies as shown in figure 2.
- (d) No discontinuities greater than 1 microsecond

8.7 Durability - Standard laboratory procedure

- (a) Number of Cycles : 50 cycles plating for gold flash
- (b) Number of Cycles : 500 cycles plating for 30u" gold
- (c) Cycling Rate : 5 inches per minute

8.8 Solderability - MIL-STD-202G, Method 208H

- (a) Steam Aging : 8 hours, 93°C, 100% RH
- (b) The solder tail of terminal and the grounding clip after evaluated shall meet the Method 208 requirements.

**9.0 QUALITY ASSURANCE PROVISIONS**

9.1 Equipment Calibration

All test equipment and inspection facilities used in the performance of any test shall be maintained in a calibration system in accordance with MIL-C-45662 and ISO 9000.

9.2 Inspection Conditions

Unless otherwise specified herein, all inspections shall be performed under the following ambient conditions:

- (a) Temperature : 25±5°C
- (b) Relative Humidity : 30% to 80%
- (c) Barometric pressure : Local ambient



NUMBER <b>GS-12-350</b>	TYPE <b>Product Specification</b>		
TITLE <b>HIGH DENSITY D-SUBMINIATURE CONNECTORS</b>		PAGE 9 of 11	REVISION A
		AUTHORIZED BY Jason Hsu	DATE 12/10/2009
CLASSIFICATION <b>CONFIDENTIAL</b>			

### 9.3 Acceptance

9.4.1 Electrical and mechanical requirements placed on test samples as indicated in paragraphs 6.0 and 7.0 shall be established from test date using appropriate statistical techniques or shall otherwise be customer specified, and all samples tested in accordance with this product specification shall meet the stated requirements.

9.4.2 Failures attributed to equipment, test setup, or operator error shall not disqualify the product. If product failure occurs, corrective action shall be taken and samples resubmitted for qualification.

### 9.4 Qualification Test

Qualification testing shall be performed on sample units produced with equipment and procedures normally used in production. The test sequence shall be as shown in Table II.

NUMBER <b>GS-12-350</b>	TYPE <b>Product Specification</b>		
TITLE <b>HIGH DENSITY D-SUBMINIATURE CONNECTORS</b>		PAGE <b>10 of 11</b>	REVISION <b>A</b>
		AUTHORIZED BY <b>Jason Hsu</b>	DATE <b>12/10/2009</b>
CLASSIFICATION <b>CONFIDENTIAL</b>			

TEST	PARA.	TEST GROUP							
		1	2	3	4	5	6	7	8
		TEST SEQUENCE							
EXAMINATION OF PRODUCT	5.4	1 9	1 6	1 8	1 7	1 3	1 5	1 5	1 5
CONTACT RESISTANCE	6.1	2 8	2 5		2 4		2 4	2 4	
INSULATION RESISTANCE	6.2			2 6					
DIELECTRIC WITHSTAND	6.3			3 7					
CURRENT RATING	6.4					2			
MATING/UNMATING FORCE	7.1	3 6							
CONTACT INSERTION/WITH-DRAWL FORCE	7.2	4 7			5				
CONTACT RETENTION	7.3				6				2
BOARD LATCH RETENTION/INSERTION	7.4								3
THERMAL SHOCK	8.1			4					
HUMIDITY, STEADY STATE	8.2			5					
HIGH TEMPERATURE LIFE	8.3				3				
HYDROGEN SULFIDE(H2S)	8.4						3		
SALT SPRAY	8.5							3	
VIBRATION	8.6		3						
MECHANICAL SHOCK	8.7		4						
DURABILITY	8.8	5							
SOLDERABILITY	8.9								4
SAMPLE SIZE		4	4	4	4	4	4	4	4

This document is the property of and embodies CONFIDENTIAL and PROPRIETARY information of FCI. No part of the information shown on the document may be used in any way or disclosed to others without the written consent of FCI. Copyright FCI.

NUMBER <b>GS-12-350</b>	TYPE <b>Product Specification</b>		
TITLE HIGH DENSITY D-SUBMINIATURE CONNECTORS		PAGE 11 of 11	REVISION A
		AUTHORIZED BY Jason Hsu	DATE 12/10/2009
CLASSIFICATION <b>CONFIDENTIAL</b>			

**Revision Record**

<u>Revision</u>	<u>Page</u>	<u>Description</u>	<u>ECN No</u>	<u>Date</u>
A	All	New release	T09-1157	12/10/09

This document is the property of and embodies CONFIDENTIAL and PROPRIETARY information of FCI. No part of the information shown on the document may be used in any way or disclosed to others without the written consent of FCI. Copyright FCI.

## X-ON Electronics

Largest Supplier of Electrical and Electronic Components

*Click to view similar products for [D-Sub Contacts](#) category:*

*Click to view products by [FCT Electronics](#) manufacturer:*

Other Similar products are found below :

[173112-0723](#) [173112-0393](#) [173112-0389](#) [173112-0750](#) [173112-0912](#) [FMP009P104](#) [FMP010P104](#) [FMP010S104](#) [FMP016P104](#)  
[FMP016S104](#) [FMP051S110](#) [FMX006S128B](#) [124C25029X](#) [131A11039X](#) [132A11019X](#) [132J22039X](#) [132A11029X](#) [132A12059X](#)  
[132C12029X](#) [RMPIR01S02E2RLF](#) [DM53744-1](#) [1757912-1](#) [188582-000](#) [162A11839X](#) [162A11889X](#) [1757913-1](#) [FK20S18-02V\\_100](#)  
[FMP006S110](#) [FMP009S104](#) [FMP139S115](#) [212558-1](#) [D02-22-26P-10000](#) [L17DM53744217](#) [D-610-10CS2820](#) [030-1955-000](#) [030-50634](#)  
[053744-0098](#) [053744-0099](#) [053745-0105](#) [053745-0111](#) [601064N004](#) [601098N003](#) [6-745288-2](#) [D-610-10CS2962](#) [86303057NLF](#)  
[DM537425001NCLF](#) [131A11019X](#) [173112-0045](#) [162A11819X](#) [1731120397](#)