

PRODUCT NUMBER
SEE PART NO. TABLE

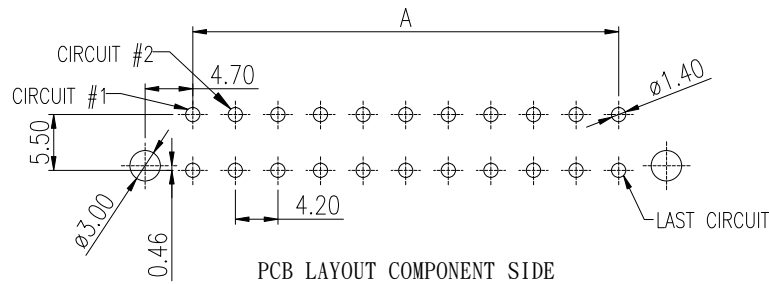
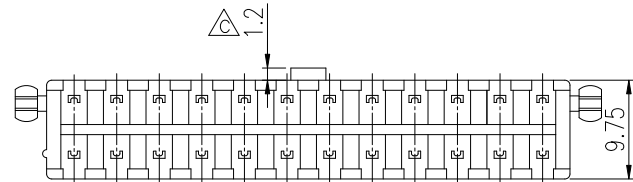
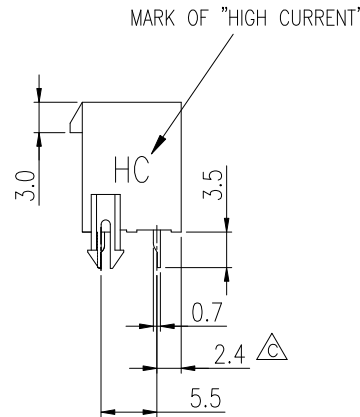
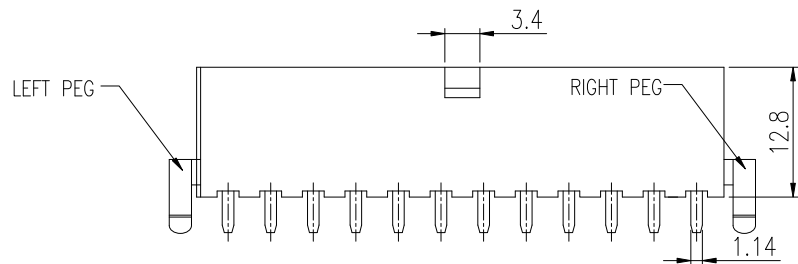
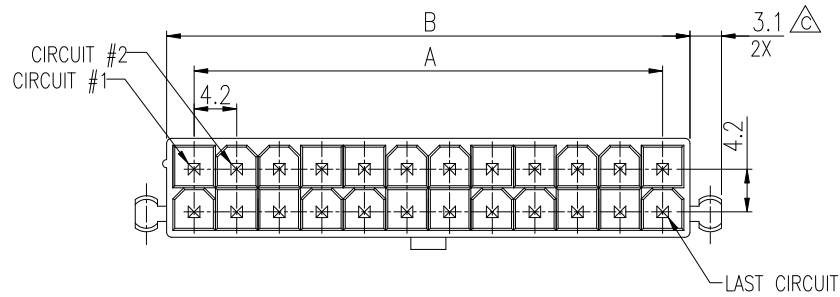

PCB LAYOUT COMPONENT SIDE

NOTES:

- MATERIAL:
HSG: NYLON 66, UL94V-0. OPTIONAL COLORS.
TERMINAL: HIGH CONDUCTIVITY COPPER ALLOY.
PLATING: OPTIONAL ON CONTACT AREA.
- THIS HEADER MATES WITH FCI RECEPTACLE WIRE CONNECTOR 10127815, CRIMP WITH 10130517 FOR HIGH CURRENT APPLICATION.
- PRODUCT SPECIFICATION: GS-12-1333.
- PACKAGE SPECIFICATION: GS-14-2362.
- THE HOUSING WILL WITHSTAND EXPOSURE TO 235°C PEAK TEMPERATURE FOR 5 SECONDS IN A WAVE SOLDER APPLICATION WITH A 1.6mm MINIMUM THICK CIRCUIT BOARD.
- PART NUMBER SCHEME:
10131319- XX X X X X L F

POS. CODE:		LOCATING PEG:
02: 2 POS.		0: NONE
04: 4 POS.		P: BOTH PEGS
24: 24 POS.		

PLATING CODE:		GLOW WIRE COMPATIBLE:
1: GOLD FLASH		0: NO
2: TIN		G: YES

HSG COLOR:		HSG MATERIAL:
1: NATURAL		1: NYLON 66
2: BLACK		

7. DIMENSIONAL & PART NO. TABLE:

PART NUMBER	POS.	A	B
10131319-02XX1XXLF	02		5.4
10131319-04XX1XXLF	04	4.2	9.6
10131319-06XX1XXLF	06	8.4	13.8
10131319-08XX1XXLF	08	12.6	18.0
10131319-10XX1XXLF	10	16.8	22.2
10131319-12XX1XXLF	12	21.0	26.4
10131319-14XX1XXLF	14	25.2	30.6
10131319-16XX1XXLF	16	29.4	34.8
10131319-18XX1XXLF	18	33.6	39.0
10131319-20XX1XXLF	20	37.8	43.2
10131319-22XX1XXLF	22	42.0	47.4
10131319-24XX1XXLF	24	46.2	51.6

mat'l. code		surface		tolerance		projection		product family	
						MM		Minitek Pwr4.2 HCC	
ltr		ecn no		dr		date		title	
A		TAI		2014-08-29				MINITEK PWR4.2 HIGH CURRENT	
B		ELX-T-19532		TAI		2014-11-24		CONNECTOR, V/T DIP HEADER	
C		ELX-T-21754		TAI		2015-08-24		scale	
				dr		KENNY TAI		2014-08-12	
				enr		KENNY TAI		2014-08-12	
				chr		KENNY TAI		2014-08-12	
				appd		PM ZHENG		2014-08-29	
sheet index		revision sheet		C		C		dwg no	
				1		2		sheet 1 of 2	
								size	
								A4	
								type	
								CUSTOMER Drawing	

PRODUCT NUMBER
SEE PART NO. TABLE

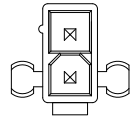

2 POS

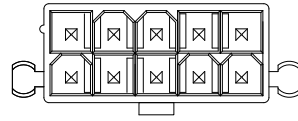

10 POS

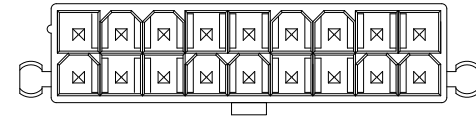

18 POS

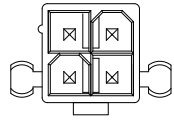

4 POS

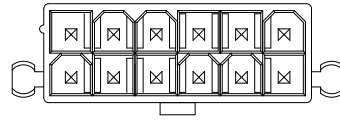

12 POS

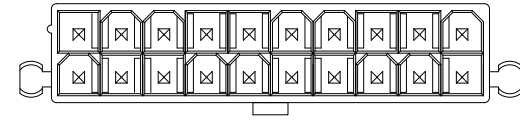

20 POS

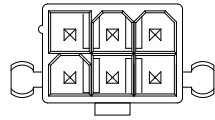

6 POS

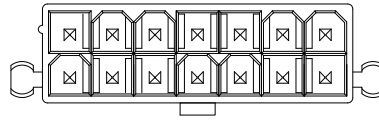

14 POS

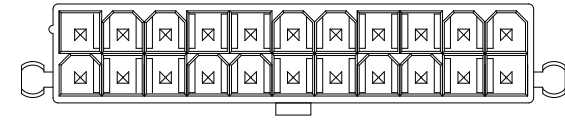

22 POS

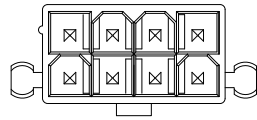

8 POS

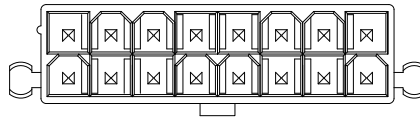

16 POS

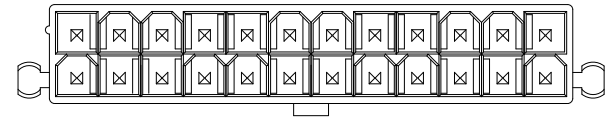

24 POS

mat'l. code		surface		tolerance		projection		product family	
								Minitek Pwr4.2 HCC	
ltr		ecn no		dr		date		title	
								MINITEK PWR4.2 HIGH CURRENT CONNECTOR, V/T DIP HEADER	
				angles $X^\circ \pm 1^\circ$		tolerances unless otherwise specified X.X ± 0.4 X.XX ± 0.3		scale	
						dr KENNY TAI 2014-08-12 engr KENNY TAI 2014-08-12 chr KENNY TAI 2014-08-12 appd PM ZHENG 2014-08-29		dwg no sheet 2 of 2 size 10131319 A4	
								type CUSTOMER Drawing	
sheet index		revision sheet		C 1		C 2			

X-ON Electronics

Largest Supplier of Electrical and Electronic Components

Click to view similar products for [Power to the Board](#) category:

Click to view products by [Amphenol](#) manufacturer:

Other Similar products are found below :

[10131318-08512GRLF](#) [6450171-4](#) [6450552-7](#) [6600323-8](#) [6643429-1](#) [6646040-2](#) [6651939-1](#) [6766604-1](#) [120959-1](#) [1393557-2](#) [1393532-2](#)
[1393532-3](#) [1393532-4](#) [1393557-1](#) [1600812-5](#) [1-6450861-2](#) [1645595-1](#) [1743490-1](#) [1744132-7](#) [1761122-1](#) [1766169-1](#) [1766250-1](#) [18362](#)
[1892109-1](#) [1-967627-6](#) [2226808-1](#) [2-6450860-5](#) [2-6450860-6](#) [2-6450870-0](#) [93003-0502](#) [953552-1](#) [1-6450161-4](#) [1-6450850-6](#) [1645526-2](#) [1-](#)
[6600130-0](#) [1743419-1](#) [1766150-1](#) [2005243-2](#) [211110-1](#) [2-6600130-2](#) [TE34-12-16P-F0](#) [51700-10201602AALF](#) [5-6450830-6](#) [5646956-4](#)
[36662-0005](#) [40585-3000](#) [4-6450830-9](#) [4-6600333-3](#) [51142-0214](#) [10125416-4050LF](#)