



Pushbutton
A

NE-18 Series Mains / Power Switches

Features/Benefits

- Chassis or panel mount
- Various buttons
- Various contact configurations
- RoHS compliant

Typical Applications

- Mains/power switching
- Consumer electronics
- Audio equipment
- Digital products

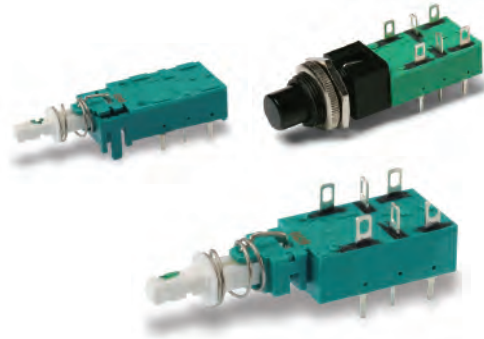

UL61058-1  

Specifications

ELECTRICAL RATING:

NE18 Series:

- 8A GP, 125 VAC, 50/60 Hz, 1E4, T70
- 6A GP, 250 VAC, 50/60 Hz, 1E4, T70
- 6(4)A RM, 250 VAC, 50/60 Hz, 1E4, T70
- 6/48A RC, 250 VAC, 50/60 Hz, 1E4, T70
- 1RA, 100 VDC, 1E4, T70
- 8RA, 30VDC, 1E4, T70

NE18CTII Series:

- 4A GP, 250 VAC, 50/60 Hz, 1E4, T70
- 4/48A RC, 250 VAC, 50/60 Hz, 1E4, T70
- 1RA, 100 VDC, 1E4, T70
- 4RA, 30VDC, 1E4, T70

DIELECTRIC STRENGTH (50 Hz, 1 min.): 2000 V

OPERATING LIFE AT MAX. LOAD AND AT MAX. INRUSH CURRENT: $\wedge 10^4$ operations⁵⁾

CONTACT RESISTANCE: Initial: 50m Ω ; After 10^4 operations: 70m Ω .

INSULATION RESISTANCE: $\wedge 10^{12}$ Ω chassis – nearest contact; $\wedge 10^{12}$ Ω mains contact – mains contact; $\wedge 10^{12}$ Ω mains contact – mains contact after 10^4 operations.

LOW VOLTAGE CONTACT:

SWITCHING POWER MAX.: 12W

SWITCHING VOLTAGE MAX.: 24V

SWITCHING CURRENT MAX.: 0.5A

TOTAL TRAVEL: 4.7mm (.185 inch)

LATCHING TRAVEL: 3.3mm (.130 inch)

OPERATING FORCE: Without auxiliary low voltage contacts:

NE18: 7N (700 grams); NE18CTII: 9.5N (950 grams).

With auxiliary low voltage contacts: NE18: 8N (800 grams);

NE18CTII: 11N (1100 grams).

SEALING: Dust proof.

Materials

HOUSING, ACTUATOR & TERMINAL BOARD: Thermoplastic polyester (UL 94V-0).

MOVABLE CONTACT: Silver nickel alloy, silver plated.

FIXED CONTACTS: Silver nickel alloy, silver plated.

COMMON CONTACTS & TERMINALS: Copper alloy, silver plated.

RETURN SPRING: Music wire.

NOTE: All models are RoHS compliant and compatible.

NOTE: Specifications and materials listed above are for switches with standard options. For information on specific and custom switches, consult Customer Service Center.

Build-A-Switch

To order, simply select desired option from each category and place in the appropriate box. Available options are shown and described on pages A-97 thru A-104. For additional options not shown in catalog, consult Customer Service Center.

If requesting only a switch, select the switch as noted below. Buttons are sold separately.

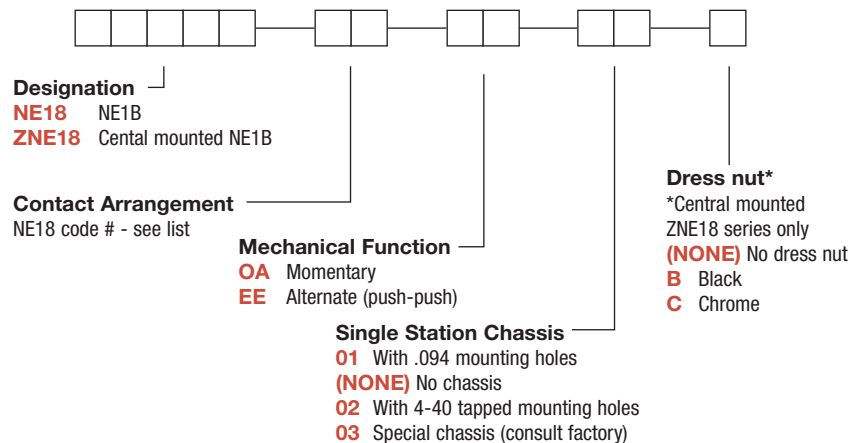

Dimensions are shown: Inches (mm)
Specifications and dimensions subject to change

NE-18 Series Mains / Power Switches



A

Pushbutton

Order Code - Buttons

Solid Buttons

<p>Style</p> <p>F01 FMR F02 FG* F12 FSC F13 FSD F14 FU12 F15 FSB F16 FE F19 FA F21 F001</p>	<p>Button Color</p> <p>01 Black 02 White 03 Red 04 Light gray</p>

Mechanical Indicator Buttons

<p>Style</p> <p>F01 FA100 F02 FA101 F07 FA120 F08 FA201 F11 FA200*</p>	<p>Shell Color</p> <p>01 Black</p>	<p>Out Position Color</p> <p>01 Black</p>	<p>In Position Color</p> <p>02 White 06 Yellow 07 Blue 08 Green 12 Orange</p>

*Button options for central mounting configurations, use 'FG' for central mount with chrome dress nut, use 'FA200' for central mount with black dress nut.

BUTTON REMOVAL

A button of a push-push switch should only be removed in the "OFF" non-latching position.

DESIGNATION & SWITCHES WITH STANDARD OPTIONS



NE1838EE

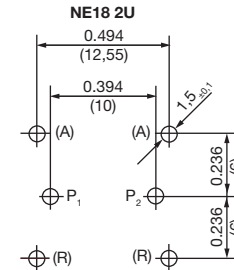
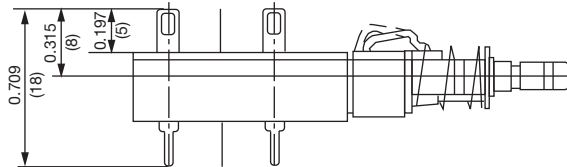
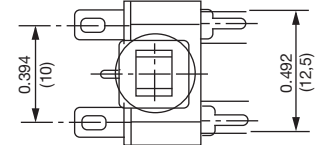
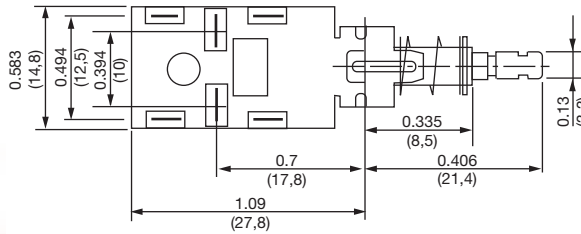
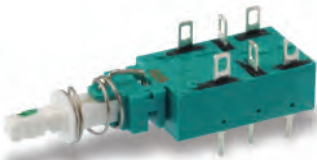

Dimensions are shown: Inches (mm)
 Specifications and dimensions subject to change



NE-18 Series Mains / Power Switches

DESIGNATION & SWITCHES WITH STANDARD OPTIONS



Pushbutton

NE1839EE

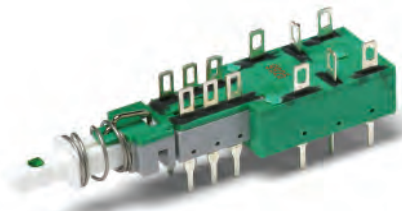
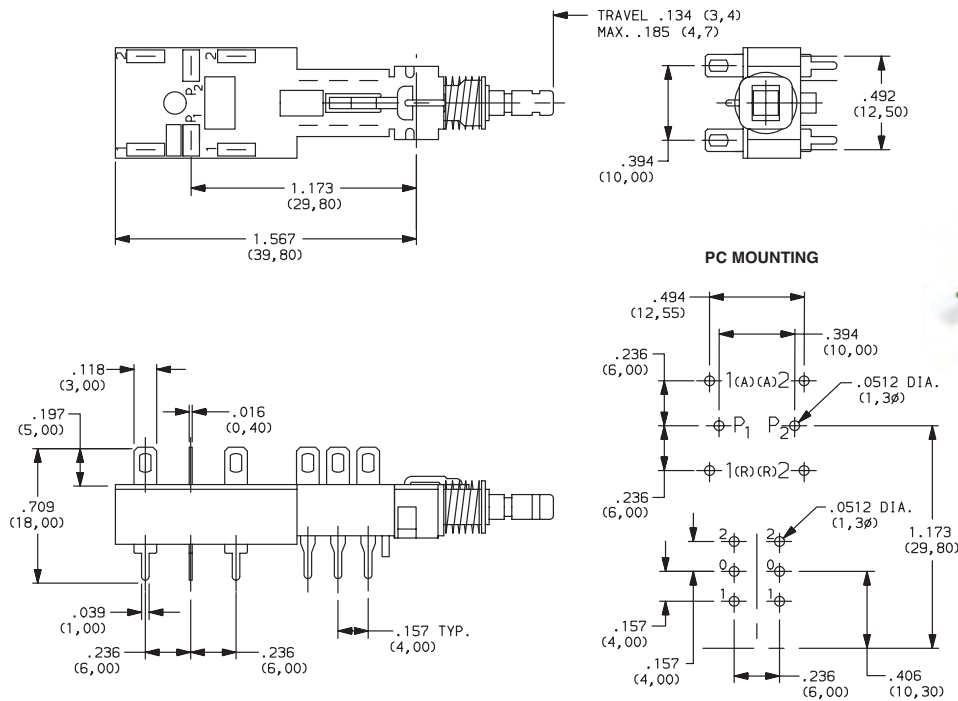

NE1846EE

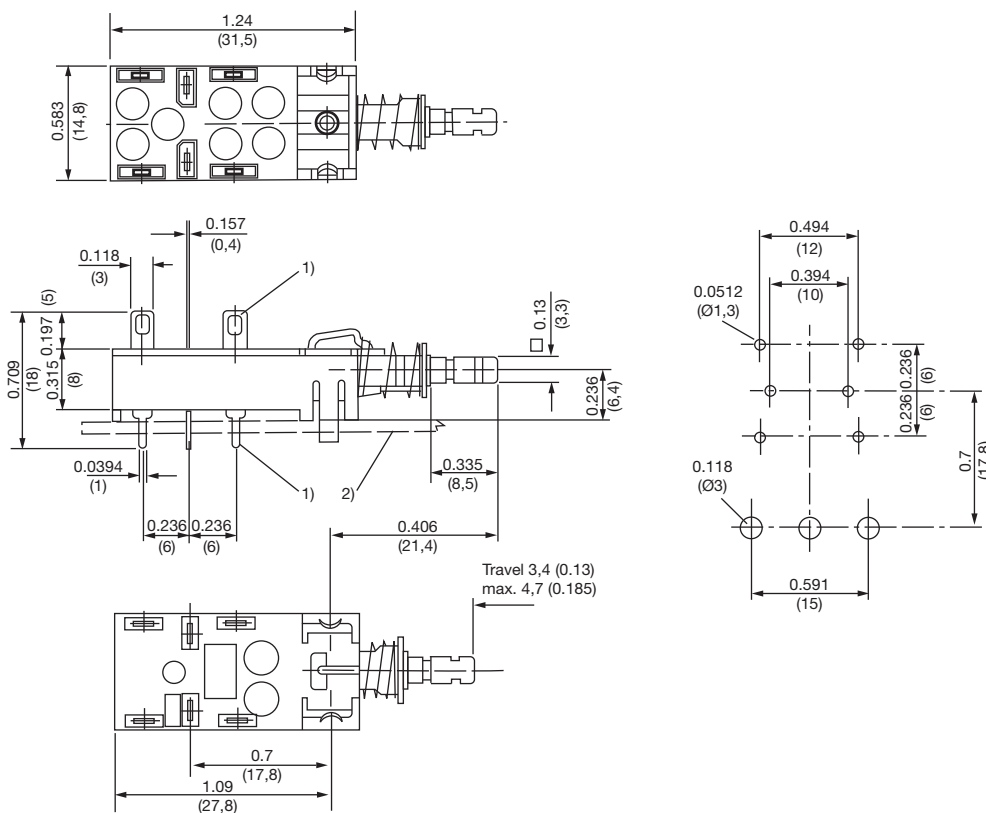

Dimensions are shown: Inches (mm)
Specifications and dimensions subject to change



NE-18 Series Mains / Power Switches



DESIGNATION & SWITCHES WITH STANDARD OPTIONS



ZNE1838EECF0201

A

Pushbutton

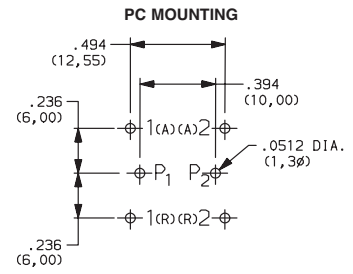
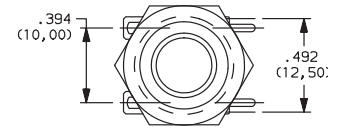
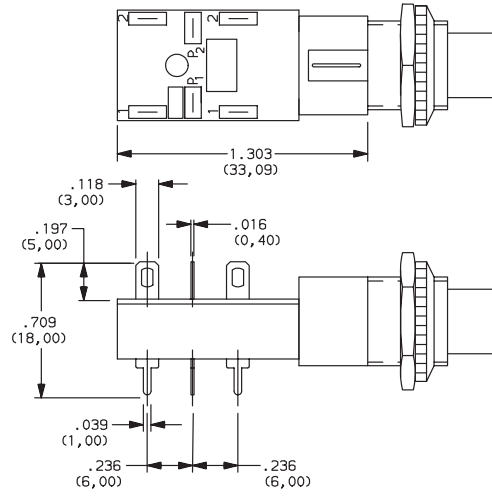

Third Angle
Projection

Dimensions are shown: Inches (mm)
Specifications and dimensions subject to change



NE-18 Series Mains / Power Switches

CONTACT ARRANGEMENT



Pushbutton
A

OPTION CODE Contact capacity and availability	STYLE	ELECTRICAL CIRCUIT
37	NE18 – 2AX	DPST
38	NE18 – 2UX	DPDT
51	2U + NE18 – 2AX	DPST*
52 (4A/64)	NE18CTII – 2AX	DPST
39	2U + NE18 – 2UX	DPDT*
41	NE18 – 2AP	DPST
42	NE18 – 2UP	DPDT
43	NE18 – 2AW	DPST
44	NE18 – 2UW	DPDT
45	NE18 – 2ASX	DPST

OPTION CODE Contact capacity and availability	STYLE	ELECTRICAL CIRCUIT
46	NE18 – 2USX	DPDT
47	NE18 – 2ASP	DPST
48	NE18 – 2USP	DPDT
49	NE18 – 2ASW	DPST
50	NE18 – 2USW	DPDT
53 (4A/64)	2U + NE18CTII – 2AX	DPST
54	2U + NE18 – 2AW	DPST
55	2U + NE18 – 2AP	DPST
56	2U + NE18 – 2UW	DPDT
57	2U + NE18 – 2UP	DPDT

* 2U + Denotes auxiliary set of low current contacts DPDT
2A = DPST
2U = DPDT
S = Snap-in mounting
X = Solder lug/PC pins
W = Solder lugs only
P = PC pins only

NOTES

- Contact plating is silver on all Power Switches.
- The electrical function is Break Before Make (BBM) on all Power Switches.
- The terminals will be epoxy sealed.

TYPE	POSSIBLE CONTACT ARRANGEMENT		CONTACT SPACING	PROTECTION CLASS (CEE 24)	APPROVALS
	POWER CONTACTS ¹	AUXILIARY CONTACTS			
NE18	2A ²	2U	> 3mm (.118 inch)	II	 UL61058-1
NE18	2A ² 2U	2U	> 3mm (.118 inch)	I	 UL61058-1
NE18CTII	2A ²	2U	> 3mm (.118 inch)	II	 UL61058-1

- A = make contact, U = changeover contact
- With 2A mains contacts: Mounting only by PC pins is not sufficient.

MECHANICAL FUNCTION



OPTION CODE	FUNCTION
OA	Momentary
EE	Alternate (push-push)

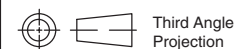

Dimensions are shown: Inches (mm)
Specifications and dimensions subject to change

NE-18 Series Mains / Power Switches



A

Pushbutton

SINGLE STATION CHASSIS



01 WITH .094 MOUNTING HOLES

(NONE) NO CHASSIS

02 WITH 4-40 TAPPED MOUNTING HOLES

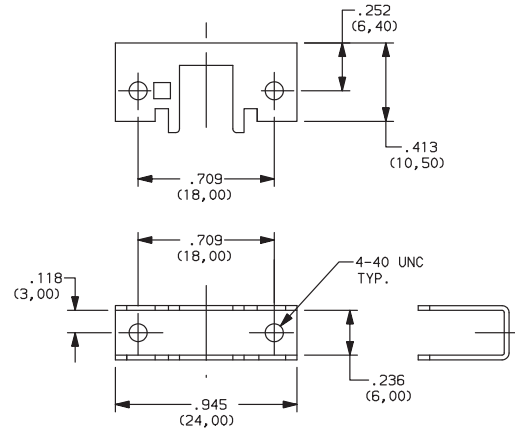
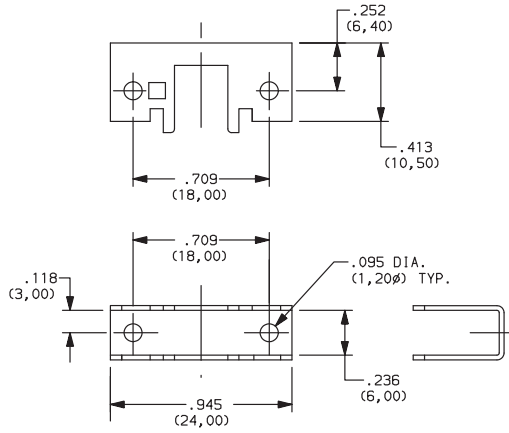

03 SPECIAL CHASSIS (CONSULT FACTORY)

DRESS NUT



(NONE) NO DRESS NUT

B BLACK

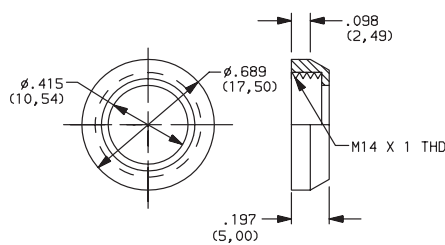

PANEL CUTOUT

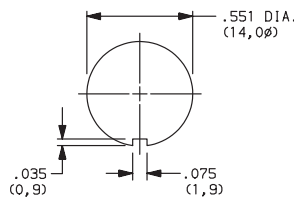

NOTE: Available with ZNE18 designation and FA200 buttons.

C CHROME

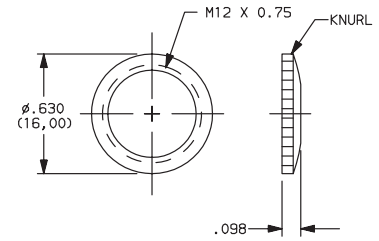

PANEL CUTOUT

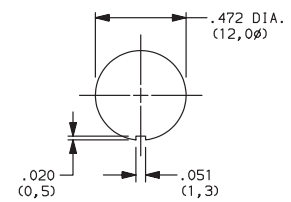

NOTE: Available with ZNE18 designation and FG button.



Third Angle
Projection

Dimensions are shown: Inches (mm)
Specifications and dimensions subject to change



NE-18 Series Mains / Power Switches

SOLID BUTTON

Pushbutton

A

STYLE

F01 FMR

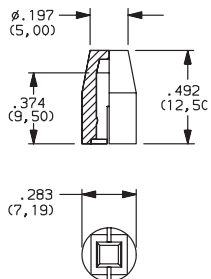

F02 FG

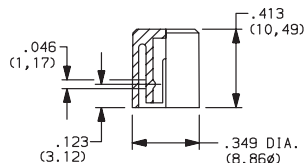

F12 FSC

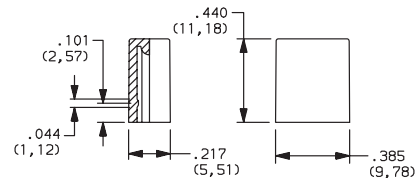
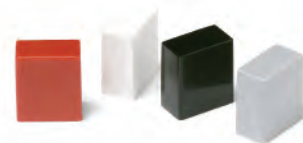

F13 FSD

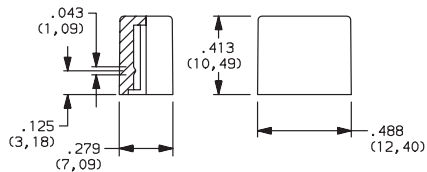
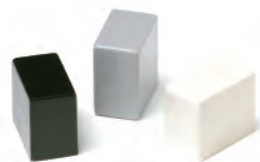

F14 FU12

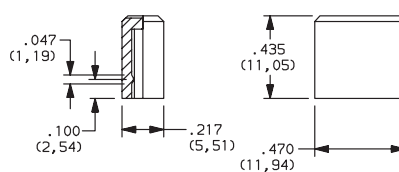

F15 FSB

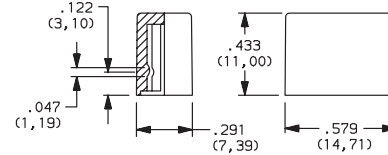
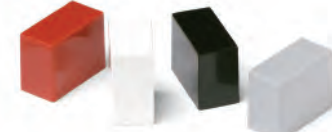

F16 FE

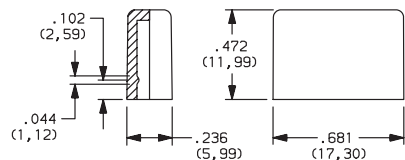

F19 FA

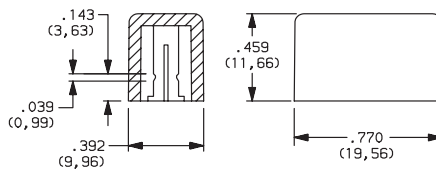

OPTION CODE	COLOR
01	BLACK
02	WHITE
03	RED
04	LT. GRAY



Dimensions are shown: Inches (mm)
Specifications and dimensions subject to change



NE-18 Series Mains / Power Switches



A

Pushbutton

SOLID BUTTON



STYLE

F21 F001

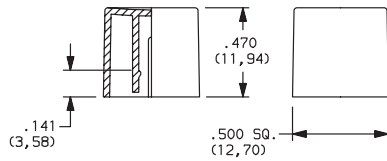

OPTION CODE	COLOR
01	BLACK
02	WHITE
03	RED
04	LT. GRAY
09	BLACK/CHROME (F03, F06 & F07 buttons only)

MECHANICAL BUTTON

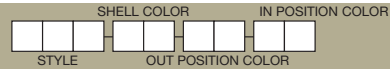

STYLE

F01 FA100

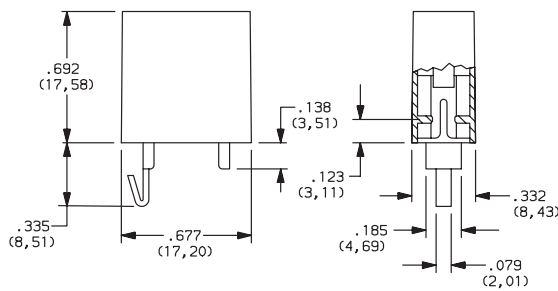

F02 FA101

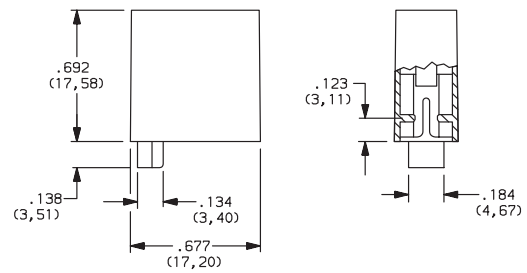

Third Angle
Projection

Dimensions are shown: Inches (mm)
Specifications and dimensions subject to change

www.ck-components.com



NE-18 Series Mains / Power Switches

MECHANICAL BUTTON

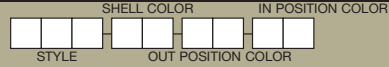

Pushbutton
A

STYLE

F08 FA201

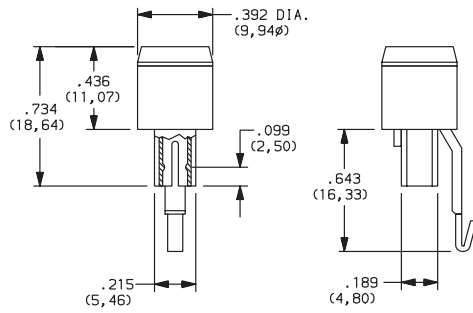

F11 FA200

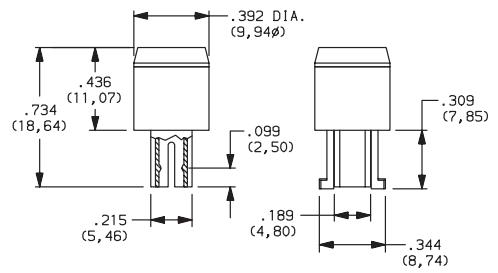

SHELL COLOR

01 BLACK

OUT POSITION COLOR

01 BLACK

IN POSITION COLOR

OPTION CODE	COLOR
02	WHITE
06	YELLOW
07	BLUE
08	GREEN
12	ORANGE

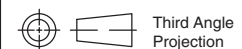

Dimensions are shown: Inches (mm)
Specifications and dimensions subject to change

X-ON Electronics

Largest Supplier of Electrical and Electronic Components

Click to view similar products for [Pushbutton Switches](#) category:

Click to view products by [C&K](#) manufacturer:

Other Similar products are found below :

[LW1L-M1C10V-A](#) [LW2L-A1C20M-GD](#) [LW2L-M1C20M-A](#) [60324L](#) [M7E-HRN2](#) [67021K512](#) [67081K512X](#) [701PB580](#) [719-5504-000](#)
[MDPSSGLFS](#) [810KSV30B](#) [MML21KA3ABK](#) [MML23KA3AC05K-001](#) [MML23KW3AA01W](#) [8418K2](#) [8646AB6X718UL](#) [8646ABUL](#)
[FSDWH](#) [9001KXRK](#) [9001T8BK](#) [9533CD4+U574+U4922](#) [1203MRA](#) [A22EM01S](#) [A595](#) [1202A6](#) [12037A2ULCSA](#) [1203A2UL](#) [ABD122N-](#)
[B](#) [1211390004](#) [ABN111-Y](#) [ABN400-R](#) [1211500044](#) [1211580012](#) [1212MRA](#) [1232A6NF](#) [RA3CSH6A](#) [1241.1183.7047](#) [1241.2511](#)
[1241.3428](#) [1223A2ULCSA](#) [1223MRA](#) [1232AX2119](#) [1241.1183.8000](#) [1241.1183.8029](#) [1241.2506](#) [1241.2606](#) [12MA6](#) [1301940184](#)
[RELBARF6X10\(PLASTIC\)](#) [13435AG](#)