

# Experience Efficiency in a New Way.



**PowerXL™**  
**Variable frequency drives**  
**The new DC1 and DA1 series**



**EATON**

*Powering Business Worldwide*

# Eaton – The Right Drive for your Technology.

In the field of plant and machinery construction Eaton is your single-source provider. Whether energy management, automation, signaling or solutions all around the motor – Eaton covers the entire machine. Variable frequency drives, soft starters, motor starters as well as hydraulics components provide solutions for all tasks involving drives.

## Motor-protective circuit-breaker PKZ

SmartWire-DT turns standard switchgear into intelligent automation devices.

## PKE motor-protective circuit-breakers

Knowing exactly how much power a motor is using at all times has clear benefits: Overload increases machine availability.

## DS7 soft starters

Through SmartWire-DT the PLC has direct access to all of the soft starter's parameters.

## Electronic motor starter EMS

EMS electronic motor starters combine DOL starting, reversing starting, and motor protection features on a mere 30 mm. In addition, the use of SmartWire-DT eliminates the need for control wiring, making commissioning even faster.

## PowerXL™ variable frequency drives

All variable frequency drives of the new PowerXL™ family DC1 and DA1 can be connected to SmartWire-DT.

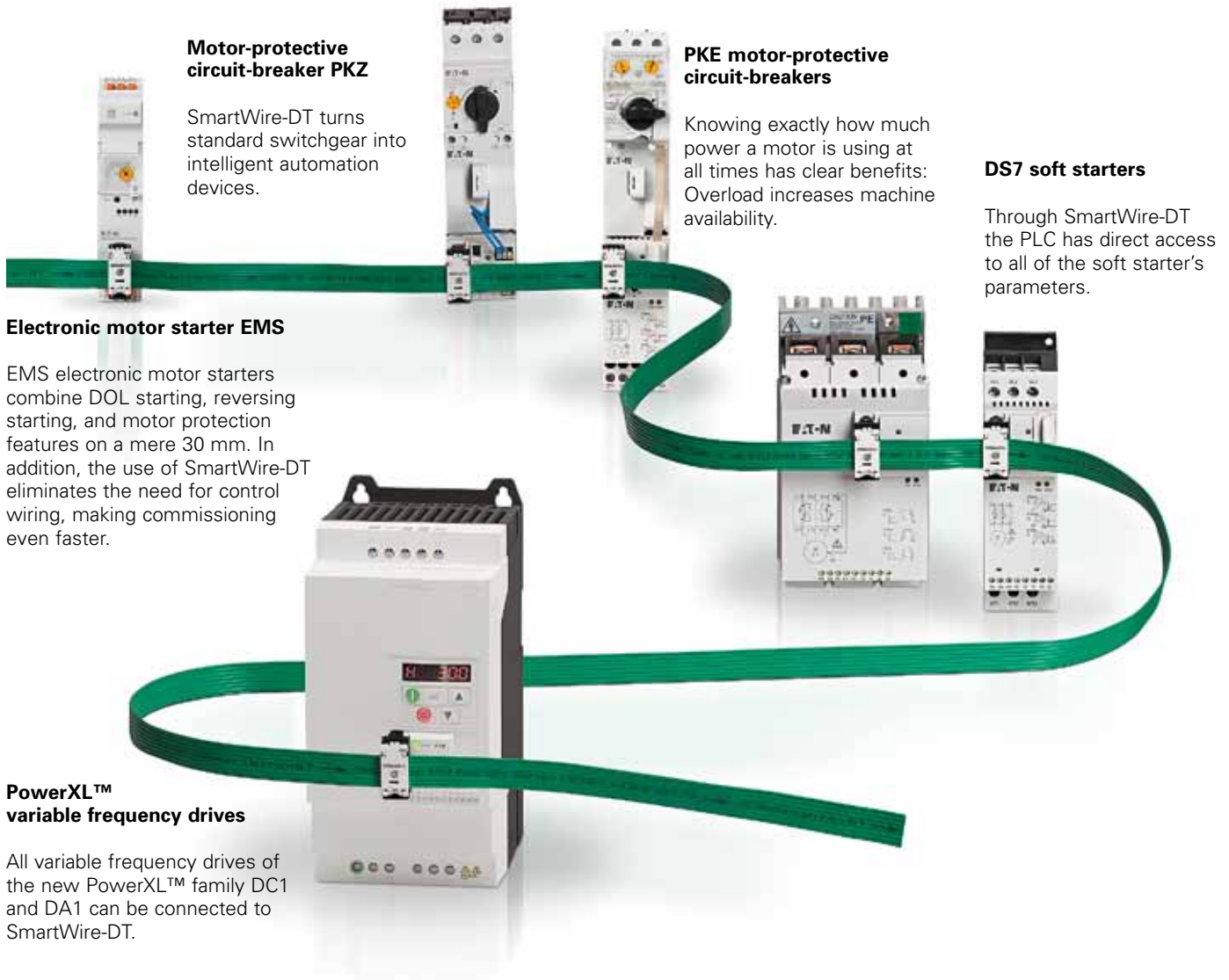

## Lean Solution powered by SmartWire-DT®

Machinery construction needs a technology that simplifies its processes. SmartWire-DT moves the I/O level to the devices, allowing simple, quickly engineered structures without an I/O level at the PLC. Data transparency simplifies diagnostics and maintenance, thereby reducing wiring, testing and commissioning time and costs by up to 85%.

## Example: Savings at every stage of the lifecycle

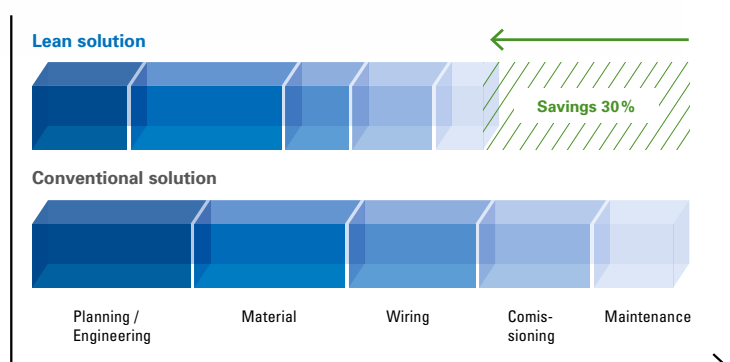

### Ahead of the future

Machinery construction is becoming increasingly demanding and competitiveness depends more and more on the technology and on the suppliers's capability to present themselves effectively on the market. Eaton is your right partner to help you achieve these aims. From effective detail solutions through overall efficiency to our comprehensive service we provide al-inclusive solutions on a national and global level.

### A focus on drives engineering

With its Moeller Series products Eaton has been a reliable partner in machinery engineering for many decades. Product brands such as PKZ and RMQ-Titan

prove the point. A further focus is on drives engineering, which is continually being expanded with innovative new products. The development focus here is on the efficiency of your processes and solutions.

### Lean Solution for drives engineering

Our intelligent connection and communications technology SmartWire-DT is gaining popularity and is successfully establishing in all segments. The core of the Lean Solutions strategy is the identification and optimization of the operating sequences in machinery and control panel construction. Our product portfolio – from motor starters through soft starters to variable frequency drives – has continued to expand to the present day.



Eaton produces world market products for machinery construction.



Eaton has a local presence for its customers in more than 150 countries. [www.eaton.eu/electrical/customersupport](http://www.eaton.eu/electrical/customersupport)



For CAD data for our products see on [www.moeller.net/cad](http://www.moeller.net/cad)



Get your new Drives Engineering catalog today: [Antriebstechnik@eaton.com](mailto:Antriebstechnik@eaton.com)



# PowerXL™ – Rugged on the Outside, Efficient on the Inside.

With its new PowerXL™ family Eaton introduces two rugged and simple variable frequency drives. From simple to highly complex applications, we always have the right product, also for series production in mechanical engineering and beyond.

Sufficient **Performance** for any application:

**DA1:** 200% torque at 0 rpm

**DC1:** 150% torque at low speed

Concise overview of parameters: **information card**

**Easy Commissioning** with only 14 basic parameters

**Clear navigation** through self-explanatory menu structure

**Series production** made easy, thanks to parameter copy function through communication stick

**Simple Mounting** on top-hat rails

**Savings in the control panel**  
No derating even at 50 °C. allowing side-by-side mounting in compact control panels without fan.



**Cohesiveness:**  
Connection to SmartWire-DT®

**Fast Installation** through plug-in terminal strip

High degree of **protection:**  
Housings with up to IP66 available



With their high degree of protection (IP66) the PowerXL™ variable frequency drives are perfectly protected against dust.

Thanks to the enhanced PCB protection the DA1 devices are also suitable for use in environments with high air humidity.

The high protection type (IP66) allows the variable frequency drives to be used in areas in which they are exposed to moisture or spray water.



### Convincing technology

In machinery construction and in conveying and building services engineering motors often drive pumps, fans, conveyors, cranes, winding machines, compressors or elevators. This calls for simple, user-friendly and energy-efficient technology. The new PowerXL™ variable frequency drives DC1 and DA1 have been specially designed for this kind of application and excel with their rugged design, availability and universal functionality.

### Rugged design

All devices unfold their full performance at an ambient temperature of up to 50 °C (IP20) and feature a short-circuit proof output. Fans with rolling bearings and an exceptionally long service life increase reliability. The rugged design is

also reflected in the devices' degree of protection: Both device series are available for ratings up 7.5 kW and with degree of protection IP66.

### Simplifying technology

With their self-explanatory keys to part numbers, auto-tune function, convenient parameterization (only 14 basic parameters) and fast engineering and commissioning these devices help minimize planning, installation and technical support costs.

The PowerXL™ variable frequency drives can be programmed with keypad and LED or OLED (multi-language display) and from a PC. With a Bluetooth PC stick parameter settings can be quickly transferred to other devices.

## Simple Parameterization

The parameters can be easily set, for example with the variable frequency drive's 7-digit display assembly. With only 14 basic parameters you can quickly set the motor's rating (motor voltage, current, frequency etc.) to take your applications into operation almost straight away.

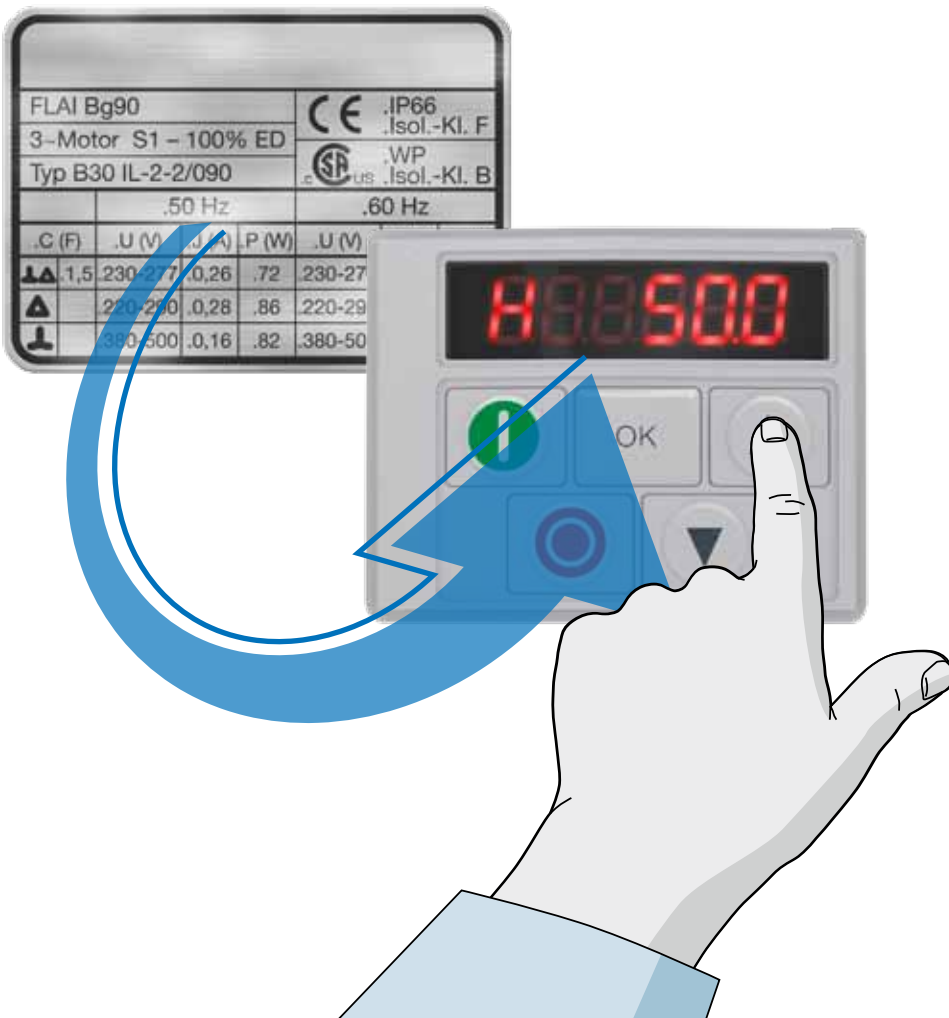

The information card in each device provides a quick overview of parameters and terminals



With the communication stick you can simply and quickly copy all parameters from one variable frequency drive to another.



The removable control signal terminals of DC1 and DA1 make installation and connecting devices much simpler.



Up to 63 devices can be accessed through a keypad mounted in the control panel.

# DC1 – The Ideal Solution for Conventional Motors.

The DC1 is Eaton’s compact variable frequency drives. Simple to mount and install, the DC1 is ideal for fans, pumps and conveyors. Additional parameters and functionalities can be enabled to master more demanding applications.



Standard applications such as pumps, conveyor belts and fans can be implemented easily and quickly by simply configuring the basic parameters.



### Perfect adaptability

The DC1 controls motors with U/f characteristics mode. To also allow control of high-torque motors at low speeds, the torque can be increased. The DC1 series can run a motor at 150% rated load for 60 seconds and at 175% for two seconds. A built-in PI controller can be used externally, allowing a control circuit to be set up, for example by connecting sensors for flow or pressure control to the device's 0-10 V analog input.

### Flexible expansion capability

All models come with a 7-digit display assembly and a keypad are optionally available with a built-in EMC filter or braking transistor.

Should the variable frequency drive's basic equipment level not be sufficient,

it can be easily extended with expansion modules, for example with additional I/O.

### Universal application

In addition to the control panel version in IP20 up to 11 kW devices with a high degree of protection (IP66) for up to 7.5 kW for remote applications are available. With mains voltages of 115V, 230V and 400V and the required CE, UL and c-Tick approvals the DC1 is a true global market product.

Variable frequency drive DC1 is also fully equipped for communications, featuring a CANopen and Modbus RTU interface as standard and – in conjunction with the SWD module – with SmartWire-DT capability.

### Control methods: Voltage/frequency (U/f) control and voltage boost

part no.	Input voltage	Output voltage	Assigned motor rating	Degrees of protection	Note
DC1-12...	1~ 230 V	3~ 230 V	0.37 – 4 kW	IP20, IP66	Three-phase motors
DC1-32...	3~ 230 V	3~ 230 V	0.37 – 4 kW	IP20, IP66	Three-phase motors
DC1-34...	3~ 400 V	3~ 400 V	0.75 – 11 kW	IP20, IP66*	Three-phase motors
DC1-1D...	1~ 115 V	3~ 230 V	0.37 – 1.1 kW	IP20, IP66	Three-phase motors, voltage doubler
DC1-S2...	1~ 230 V	1~ 230 V	0.37 – 1.1 kW	IP20, IP66	AC motors
DC1-S1...	1~ 115 V	1~ 115 V	0.37 – 0.55 kW	IP20, IP66	AC motors

\* to 7.5kW

## No problems at 50 °C

All IP20 devices of series DC1 and DA1 support an ambient temperature of 50 °C without needing derating, i.e. the variable frequency drives can be operated at the device's full rated current.

Advantages:

- Smaller control panel possible
- No added costs for additional ventilation

In addition side-by-side mounting of the devices allows an optimized space utilization in the control panel.

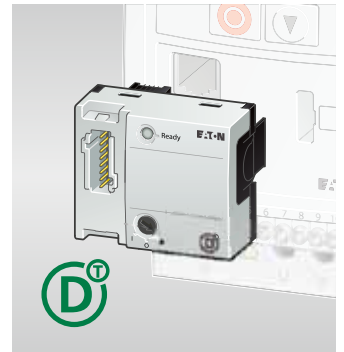
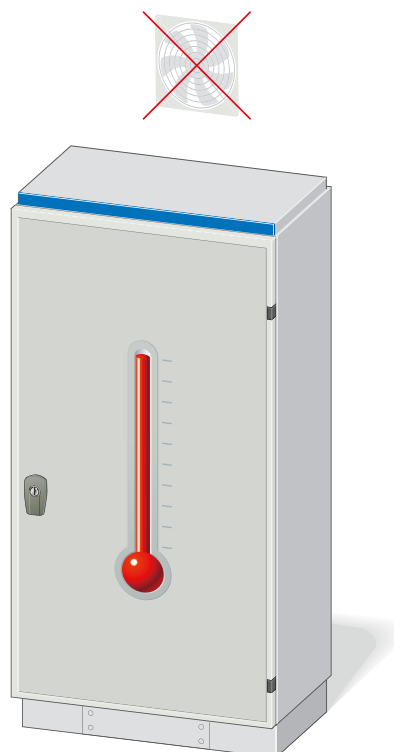

Simple connection to SmartWire-DT

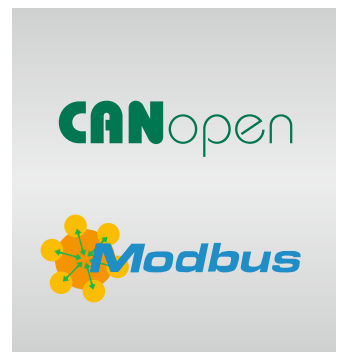

The DC1 has CANopen and Modbus RTU onboard as standard

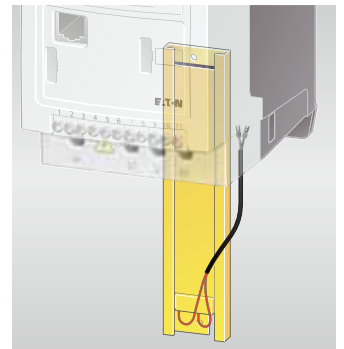

A braking resistor can be built into the enclosure.

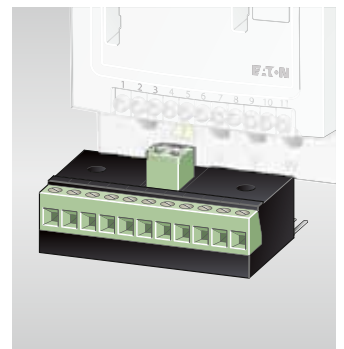

Retrofit I/O extensions optionally available



# DA1 – The Multi-talent for Demanding Drives.

DA1 variable frequency drives are the perfect match for demanding, speed-dependent and torque-dependent applications. A wide performance range of up to 250 kW, together with compact dimensions and a high level of functionality, are sure to leave a lasting impression.



Plenty of performance even for demanding lifting applications



For the DA1 DNV shipping classification will soon be available.



For Emergency Stop functionality the DA1 has the STO function built in.





### Full range of features

The DA1 series is equipped for every application as standard, supports the Modbus RTU and CANopen protocols and features a built-in EMC filter, braking transistor and a performance range up to 250 kW.

In addition to sensorless vector control (SLV) the motor can be operated at 150% in rated operation and at 200% overload at startup.

Ingress-protected to IP66 the DA1 is ideally suited for remote applications outside the control panel.

### Ready for all eventualities

The function block editor featured by the drivesConnect parameter configuration program can be used to create your own logic operations - with time dependencies, for example - so that you

can generate your own applications. A comprehensive range of expansions as well as additional inputs and outputs (analog and digital) can be added to the devices.

With the Safe Torque Off (STO) function the DA1 provides the most basic drive-integrated safety function, keeping the motor torque-free and preventing inadvertent starting.

### The communications genius

A range of field bus modules for the DA1 provide connectivity using Ethernet-based protocols (PROFINET, Ethernet/IP, EtherCAT, Modbus TCP, BACnet IP), the widely-used PROFIBUS or – for the North American market – DeviceNet. With an SWD module, the variable frequency drive can be connected to SmartWire-DT.

### Control methods: Voltage/frequency (U/f) control as well as sensorless vector (SLV) and closed-loop vector (CLV) control

part no.	Input voltage	Output voltage	Assigned motor rating	Degrees of protection	Note
DA1-12...	1~ 230 V	3~ 230 V	0.75 – 2.2 kW	IP20, IP66	Three-phase motors
DA1-32...	3~ 230 V	3~ 230 V	0.75 – 75 kW	IP20, IP55, IP66*	Three-phase motors
DA1-34...	3~ 400 V	3~ 400 V	0.75 – 250 kW	IP20, IP40, IP55, IP66**	Three-phase motors

\* up to 4 kW, \*\* up to 7.5 kW

## Ideal for all heavyweights

The sensorless vector control (SLV) of variable frequency drives DA1 offers 200% torque at 0 rpm, making it ideal for crane applications.

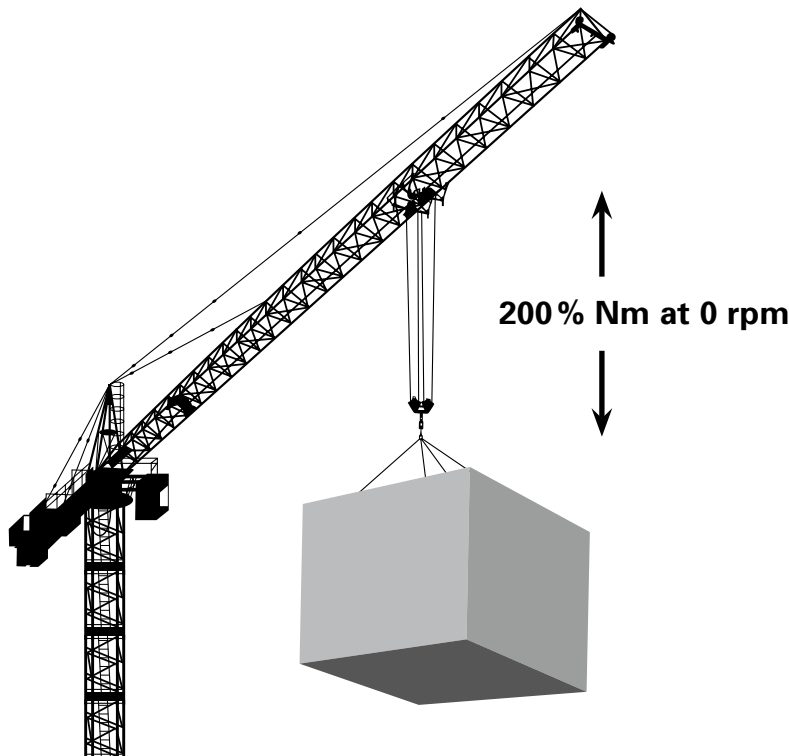

High-resolution OLED display with language selection available for all ratings

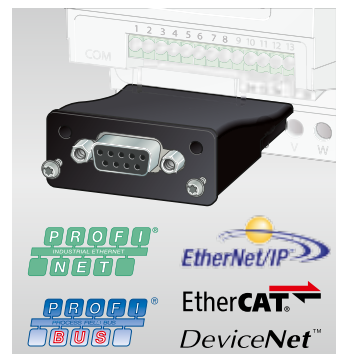

All common field bus types available as modules.



DA1 can be used to drive high-efficiency permanent-magnet motors

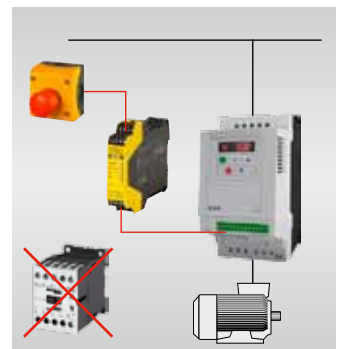

The built-in STO (Safe Torque Off) safety function makes a mains contactor unnecessary.

# drivesConnect – the Software for Optimum Implementation.

The drivesConnect software for PCs is a powerful commissioning tool for the PowerXL™ family. Beside parameterization and diagnosis user-defined internal logic links can be set up through a PLC function and transferred to the variable frequency drives.



## PC connection

### Hardwired:

With a hardwired USB connection you can connect up to 63 variable frequency drives with the PC and conveniently parameterize them with the software and used with the PLC's functionality.

### Wireless (Bluetooth):

The communications sticks can be used to establish a wireless Bluetooth connection to the variable frequency drives.

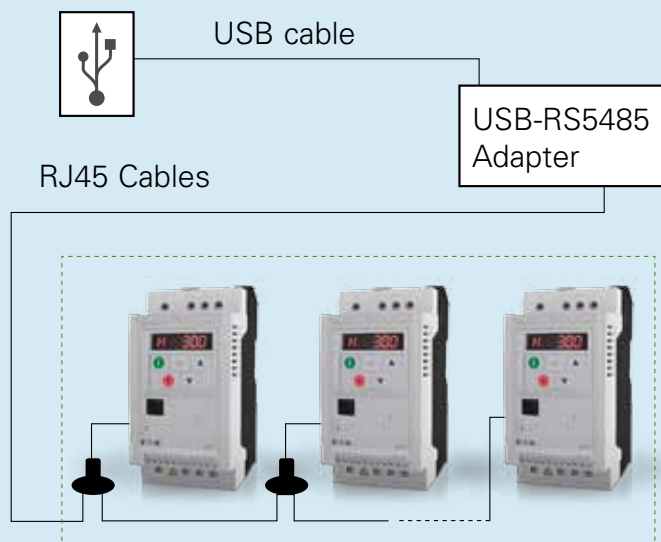

# Parameterization

## Online and offline

The parameterization function has an uncluttered, easy to understand user interface. With the editor variable frequency drives can be parameterized both online and offline. In online mode monitor values can be used for diagnostics.

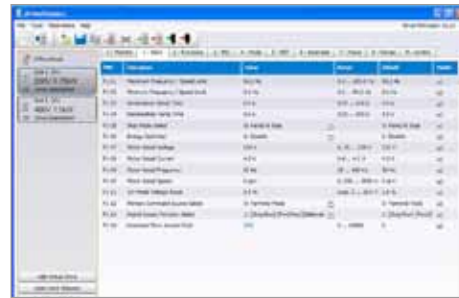

# Function block editor

## Simple Programming

The function block editor can be used to create separate logic operations for the DA1 - with time dependencies, for example - within the variable frequency drive in order to generate original applications. This makes it possible to adapt the variable frequency drive to any application, cutting down on additional hardware costs in the process.

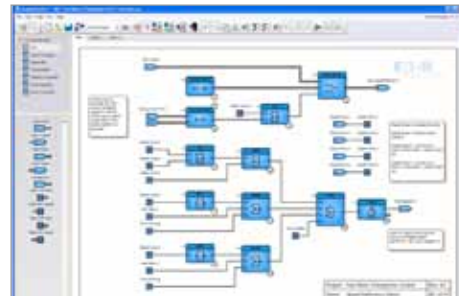

# Selection aid

## Efficient planning and engineering

An electronic selection aid provides simple planning, helping you quickly select the drive required for your application and the associated switchgear, protective elements chokes and filters complete with the corresponding article number.

[www.eaton.eu/selectiontools](http://www.eaton.eu/selectiontools)



# Scope/data logger function

This 4-channel data logging function can be used to graphically log any variable frequency drive parameters in trigger or continuous operation modes. The corresponding data can also be optionally exported as a data file.

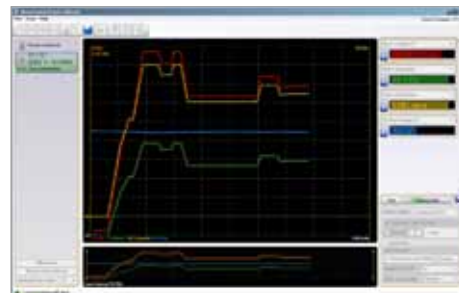

# Drive control/monitor

PowerXL variable frequency drives can be easily controlled through a computer, making commissioning them a simple process. Up to seven parameter values can be shown online.

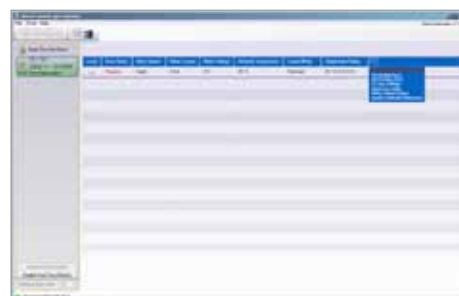

Eaton is dedicated to ensuring that reliable, efficient and safe power is available when it's needed most. With unparalleled knowledge of electrical power management across industries, experts at Eaton deliver customized, integrated solutions to solve our customers' most critical challenges.

Our focus is on delivering the right solution for the application. But, decision makers demand more than just innovative products. They turn to Eaton for an unwavering commitment to personal support that makes customer success a top priority. For more information, **visit [www.eaton.eu](http://www.eaton.eu)**

**To contact an Eaton salesperson or local distributor/agent, please visit [www.eaton.eu/electrical/customersupport](http://www.eaton.eu/electrical/customersupport)**

**Eaton Industries GmbH**  
Hein-Moeller-Str. 7-11  
D-53115 Bonn/Germany

© 2012 by Eaton Corporation  
All rights reserved  
Printed in Germany 10/13  
Publication No.: BR040001EN  
bb October 2013  
Article No.: 170494



Eaton is a registered trademark of Eaton Corporation.

All other trademarks are property of their respective owners.

SmartWire-DT® is a registered trademark of Eaton Corporation.



## X-ON Electronics

Largest Supplier of Electrical and Electronic Components

*Click to view similar products for [Controllers](#) category:*

*Click to view products by [Eaton](#) manufacturer:*

Other Similar products are found below :

[CS1WCN223](#) [CS1WCN713](#) [CS1WKS001E](#) [61F-11NH](#) [61FGPN8DAC120](#) [61F-GP-NT AC110](#) [61F-GPN-V50-AC110](#) [70177-1011](#) [F03-03](#)  
[HAS B](#) [F03-03 HAS C](#) [F03-31](#) [81513201](#) [81513535](#) [81550401](#) [FT1A-C12RA-W](#) [88981106](#) [H2CAC24A](#) [R88A-CAGA005S](#) [R88A-](#)  
[CRGB003CR-E](#) [R88ARR080100S](#) [R88A-TK01K](#) [DCN1-1](#) [DTB4896VRE](#) [DTB9696CVE](#) [DTB9696LVE](#) [MR-50LF+](#) [E53-AZ01](#) [E53E8C](#)  
[E5CWLQ1TCAC100240](#) [B300LKL21](#) [NE1ASCPU02EIPVER11](#) [NE1SCPU01](#) [NE1SDRM21U](#) [NSCXDC1V3](#) [NSH5-232CW-3M](#)  
[NT20SST122BV1](#) [NV3Q-SW41](#) [NV4W-ATT01](#) [NV-CN001](#) [OAS-160-N](#) [K31S6](#) [K33-L1B](#) [K3TX-AD31A](#) [L595020](#) [SRS2-1](#) [G32X-V2K](#)  
[26546803](#) [26546805](#) [26546831](#) [CJ1W-OD204](#)