

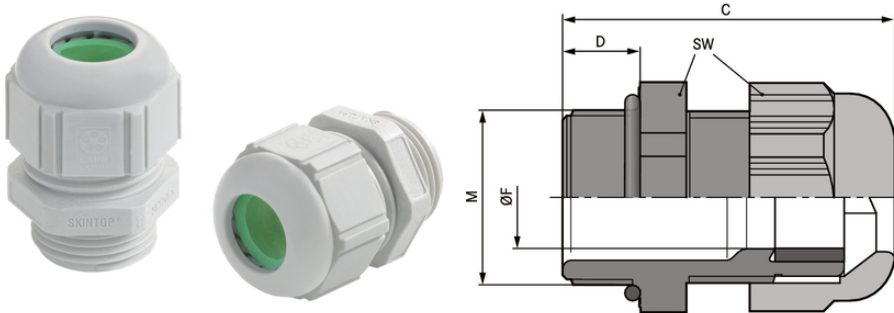





SKINTOP® ST-HF-M

SKINTOP® ST-HF-M, halogen-free, metric plastic cable gland, extremely flame-retardant and self-extinguishing, maximum reliability

Info

Cable gland for railway applications



-  Variety of approval certifications
-  Halogen-free
-  Wide clamping range
-  Good chemical resistance
-  Rail
-  Flame-retardant

Benefits

- Maximum reliability
- Extremely flame-retardant according to UL 94 V0
- Completely halogen-free (including sealing material)
- Self-extinguishing, no dripping
- Permanent vibration protection

SKINTOP® ST-HF-M

Application range

Underground railways and trains
When the protection of people and property is a priority.
Public buildings
Ventilation systems
Tunnel construction

Norm references / Approvals

DIN EN 45545-2: 2013
Filament testing according to EN 60695-2-1/1 +960°C

Product Make-up

Metric connection thread acc. to DIN EN 60423
Basis for technical information DIN IEC 62444

Technical Data

Classification ETIM 5:	ETIM 5.0 Class-ID: EC000441 ETIM 5.0 Class-Description: Cable screw gland
Classification ETIM 6:	ETIM 6.0 Class-ID: EC000441 ETIM 6.0 Class-Description: Cable screw gland
Caution:	Refer to Appendix T21 for the installation dimensions and torques
Colour delivered:	Light grey (RAL 7035)
Material:	Body: halogen-free polyamide acc. to UL 94 V0 Sealing ring: special elastomer O-ring: special elastomer
Protection rating:	IP 68 - 5 bar
Temperature range:	Fixed: -40°C to +100°C Dynamic: -20°C to +100°C

Note

Photographs and graphics are not to scale and do not represent detailed images of the respective products.
Prices are net prices without VAT and surcharges. Sale to business customers only.

Article number	Article designation / size	Clamping range ØF (mm)	SW wrench size mm	Overall length, C (mm)
SKINTOP® ST-HF-M				
53111407	M 12 x 1,5	4 - 5.5	15	30
53111417	M 16 x 1,5	4.5 - 9	19	34
53111427	M 20 x 1,5	7 - 13	25	37
53111437	M 25 x 1,5	9 - 17	30	40
53111447	M 32 x 1,5	11 - 21	36	47
53111457	M 40 x 1,5	19 - 28	46	52
53111467	M 50 x 1,5	27 - 35	55	62
53111477	M 63 x 1,5	34 - 45	66	71

Last Update (04.04.2018)
 ©2018 Lapp Group - Technical changes reserved
 Product Management www.lappkabel.de
 You can find the current technical data in the corresponding data sheet.
 PN 0456 / 02_03_16

X-ON Electronics

Largest Supplier of Electrical and Electronic Components

Click to view similar products for [Multi-Conductor Cables](#) category:

Click to view products by [Lapp Kabel](#) manufacturer:

Other Similar products are found below :

[89182-010-1000](#) [89705-008-500](#) [6000FE-877-1000](#) [CS2885-000](#) [M27500-20SP2S23](#) [6300FE-877-U1000](#) [6309UE-877-1000](#) [M3905-BK005](#)
[6502FE 8771000](#) [6541PA-008-U1000](#) [CV6807-000](#) [CW9530-000](#) [CX6543-000](#) [CXA-0066-20-4-9CS2973](#) [CXA-0078-16-1-9CS2405](#) [CXA-](#)
[0078-22-4-9CS2405](#) [CXA-0078-24-4-9CS2405](#) [CXA-0140-16-6/9-9CS2405](#) [CY0660-000](#) [720451-000](#) [752687-000](#) [768146-000](#) [773159-000](#)
[82841-877-5000](#) [83318E-009-500](#) [8348-060-500](#) [83559-002-1000](#) [83653-002-5000](#) [83659-002-1000](#) [83709-002-1000](#) [8404-060-500](#) [8469](#)
[060100](#) [858171-000](#) [8628-060-500](#) [868361-001](#) [8730-060-1000](#) [8737-060-U1000](#) [8747-060-100](#) [8747-060-1000](#) [8769-060-1000](#) [8775-060-](#)
[500](#) [877541-000](#) [8780-060-1000](#) [8782-001-U1000](#) [88444-002-1000](#) [9159-060-500](#) [939870-000](#) [9423 060U500](#) [9444 060U1000](#) [9497](#)
[0001000](#)