







SKINTOP® STR-M

SKINTOP® STR-M, increased oil-resistant plastic cable gland with permanent vibration protection and reducing seal insert

Info

Now with IP69 approval! Proven to withstand the most demanding cleaning procedures for industrial machinery with high-pressure cleaners and hot water!



-  Variety of approval certifications
-  Temperature-resistant
-  Optimum strain relief
-  Assembly time
-  Mechanical resistance
-  Maximum vibration protection
-  Wide clamping range

Application range

With reducing seal insert, to seal cables with smaller outer diameters.

Norm references / Approvals

UL File Nr. E79903
GGVS: TÜ.EGG.020-95

SKINTOP® STR-M

Product Make-up

Metric connection thread acc. to DIN EN 60423
Basis for technical information DIN IEC 62444

Note

Refer to SKINTOP® metric accessories for suitable accessories
Counter nut to be used: SKINTOP® GMP-GL-M
SKINTOP® ST(R) M ISO types have an extra-long connection thread
SKINTOP® ST(R) M ISO versions with extra-long connection thread, see table, no DNV approval

Technical Data

Classification ETIM 5:	ETIM 5.0 Class-ID: EC000441 ETIM 5.0 Class-Description: Cable screw gland
Classification ETIM 6:	ETIM 6.0 Class-ID: EC000441 ETIM 6.0 Class-Description: Cable screw gland
Caution:	Refer to Appendix T21 for the installation dimensions and torques
Colour delivered:	Silver grey (RAL 7001) Light grey (RAL 7035) Black (RAL 9005), UV-resistant
Material:	Body: Polyamide Seal: CR
Tests:	GGVS: TÜ.EGG.020-95
Protection rating:	IP 68 - 5 bar IP 69
Temperature range:	Fixed: -40 °C to +100 °C Dynamic: -20 °C to +100 °C

Note

Photographs and graphics are not to scale and do not represent detailed images of the respective products.
Prices are net prices without VAT and surcharges. Sale to business customers only.

Article number	Article designation / size	Clamping range ØF (mm)	SW wrench size mm	Overall length, C (mm)
SKINTOP® STR-M silver grey				
53111100	M 12 x 1,5	2 - 5	15	30.0
53111110	M 16 x 1,5	3.5 - 7	19	34.0
53111120	M 20 x 1,5	4 - 10	25	37.0
53111130	M 25 x 1,5	5 - 13	30	40.0
53111140	M 32 x 1,5	6 - 15	36	47.0
53111150	M 40 x 1,5	9 - 23	46	52.0
53111160	M 50 x 1,5	24 - 29	55	62.0
53111170	M 63 x 1,5	28 - 39	66	71.0
SKINTOP® STR-M black				
53111300	M 12 x 1,5	2 - 5	15	30.0
53111310	M 16 x 1,5	3.5 - 7	19	34.0
53111320	M 20 x 1,5	4 - 10	25	37.0
53111330	M 25 x 1,5	5 - 13	30	40.0
53111340	M 32 x 1,5	6 - 15	36	47.0
53111350	M 40 x 1,5	9 - 23	46	52.0
53111360	M 50 x 1,5	24 - 29	55	62.0
53111370	M 63 x 1,5	28 - 39	66	71.0
SKINTOP® STR-M light grey				
53111500	M 12 x 1,5	2 - 5	15	30.0
53111510	M 16 x 1,5	3.5 - 7	19	34.0
53111520	M 20 x 1,5	4 - 10	25	37.0
53111530	M 25 x 1,5	5 - 13	30	40.0
53111540	M 32 x 1,5	6 - 15	36	47.0
53111550	M 40 x 1,5	9 - 23	46	52.0
53111560	M 50 x 1,5	24 - 29	55	62.0
53111570	M 63 x 1,5	28 - 39	66	71.0
SKINTOP® STR M ISO silver-grey (with long metric connecting thread)				
53017110	M 16 x 1,5 ISO	2 - 6	19	40.0
53017130	M 20 x 1,5 ISO	4 - 9	24	45.0
53017140	M 25 x 1,5 ISO	6 - 12	27	47.0
SKINTOP® STR M ISO black (with long metric connecting thread)				
53017310	M 16 x 1,5 ISO	2 - 6	19	40.0
53017330	M 20 x 1,5 ISO	4 - 9	24	45.0
53017340	M 25 x 1,5 ISO	6 - 12	27	47.0

Last Update (10.04.2018)
 ©2018 Lapp Group - Technical changes reserved
 Product Management www.lappkabel.de
 You can find the current technical data in the corresponding data sheet.
 PN 0456 / 02_03.16

SKINTOP® STR-M

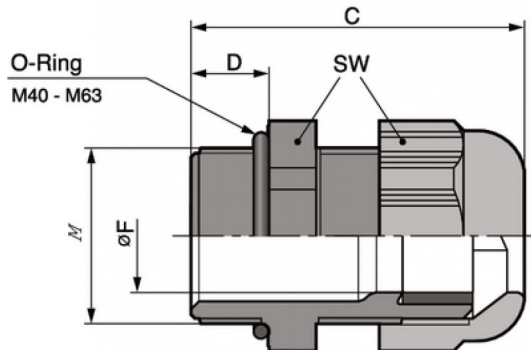

X-ON Electronics

Largest Supplier of Electrical and Electronic Components

Click to view similar products for [Cable Glands, Strain Reliefs & Cord Grips](#) category:

Click to view products by [Lapp Kabel](#) manufacturer:

Other Similar products are found below :

[120-116-1-1-20BP](#) [120-116-1-1-32BE](#) [120-117-40](#) [120-123-14](#) [120-123-16](#) [120-125-16](#) [120-125-16R](#) [120-125-16Y](#) [120-125-24Y](#) [120-125-28](#) [120-125-28R](#) [120-125-32](#) [120-125-32R](#) [120-125-40](#) [120-125-56](#) [120-126-14](#) [120-126-16](#) [120-126-20](#) [120-126-20BL](#) [120-126-20R](#) [120-126-24](#) [120-126-28](#) [120-126-32](#) [120-126-40BL](#) [120-116-1-1-06BP-509](#) [120-116-1-1-06CP](#) [120-116-1-1-16BE](#) [120-116-1-1-28BP](#) [120-123-20](#) [120-123-24](#) [120-123-32](#) [120-125-20](#) [120-125-20Y](#) [120-125-24](#) [120-125-24R](#) [120-125-28Y](#) [120-126-14BL](#) [120-126-16R](#) [120-126-16Y](#) [120-126-24BL](#) [120-126-28BL](#) [120-126-32BL](#) [120-126-40](#) [120-126-48](#) [120-126-48BL](#) [1300980012](#) [1300980105](#) [DBZM-6828](#) [1498](#) [15190-103 R2](#)