

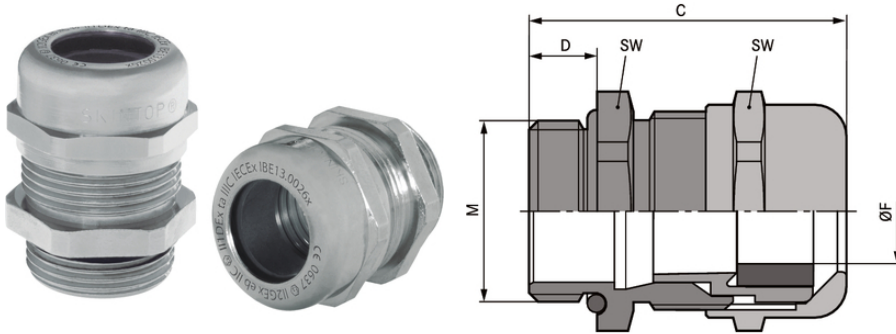





## SKINTOP® MS-M ATEX

SKINTOP® MS-M ATEX, anti-static brass cable gland with cold impact resistance and maximum reliability, explosion-proof



-  Variety of approval certifications
-  Reliability
-  Optimum strain relief
-  Mechanical resistance
-  Good chemical resistance
-  Oil & Gas

### Benefits

- Cold impact resistance
- High strain relief
- Wide, variable clamping ranges
- Maximum reliability

### Application range

- Devices, machines and apparatus of enhanced safety protection type "e"
- Equipment group II / Category 2G+1D
- For mobile applications in offshore and marine industries
- Chemical and petrochemical industry

## SKINTOP® MS-M ATEX

### Product features

SKINTOP® MS-M-XL ATEX is similar to the SKINTOP® MS-M ATEX, but has an extended connection thread for thick walls

### Norm references / Approvals

UL File Nr. E79903

### Product Make-up

Metric connection thread acc. to DIN EN 60423

Basis for technical information DIN IEC 62444

### Note

Refer to SKINTOP® SDV-M ATEX for suitable accessories

### Technical Data

Classification ETIM 5:	ETIM 5.0 Class-ID: EC000441 ETIM 5.0 Class-Description: Cable screw gland
Classification ETIM 6:	ETIM 6.0 Class-ID: EC000441 ETIM 6.0 Class-Description: Cable screw gland
Caution:	Refer to the instruction leaflet for the installation dimensions and torques
Certifications:	CE 0637 Ex II 2G Ex eb IIC Ex II 1D Ex ta IIIC IECEX IBE 13.0026X
Material:	Body: nickel-plated brass Insert: polyamide Sealing: CR O-ring: NBR
Tests:	DIN EN 60079-0 DIN EN 60079-7 DIN EN 60079-31
Protection rating:	IP 68 - 10 bar
Temperature range:	-30°C to +90°C

### Note

Photographs and graphics are not to scale and do not represent detailed images of the respective products. Prices are net prices without VAT and surcharges. Sale to business customers only.

Article number	Article designation / size	Clamping range ØF (mm)	SW wrench size mm	Overall length, C (mm)
SKINTOP® MS-M ATEX				
53112700	M 12 x 1,5	3 - 7	16	26.5
53112710	M 16 x 1,5	4.5 - 10	20	33
53112720	M 20 x 1,5	7 - 13	24	37
53112730	M 25 x 1,5	9 - 17	29	38.5
53112740	M 32 x 1,5	11 - 21	36	45.5
53112750	M 40 x 1,5	19 - 28	45	48
53112760	M 50 x 1,5	26 - 35	54	55.5
53112770	M 63 x 1,5	34 - 45	67	67
53112779	M 63 x 1,5 plus	44 - 55	75	65.5
SKINTOP® MS-M-XL ATEX				
53112800	M 12 x 1,5	3 - 7	16	26
53112810	M 16 x 1,5	4.5 - 10	20	33
53112820	M 20 x 1,5	7 - 13	24	37
53112830	M 25 x 1,5	9 - 17	29	38.5
53112840	M 32 x 1,5	11 - 21	36	45.5
53112850	M 40 x 1,5	19 - 28	45	48
53112860	M 50 x 1,5	26 - 35	54	55.5

Last Update (04.04.2018)  
 ©2018 Lapp Group - Technical changes reserved  
 Product Management [www.lappkabel.de](http://www.lappkabel.de)  
 You can find the current technical data in the corresponding data sheet.  
 PN 0456 / 02\_03.16

## X-ON Electronics

Largest Supplier of Electrical and Electronic Components

*Click to view similar products for [Cable Mounting & Accessories](#) category:*

*Click to view products by [Lapp Kabel](#) manufacturer:*

Other Similar products are found below :

[HP-4N](#) [582603-1](#) [009333-000](#) [727844N003](#) [809090N001](#) [8109](#) [843188-000](#) [843459N001](#) [843460N003](#) [8666](#) [967279N002](#) [GPQC1/0](#) [DB-](#)  
[11](#) [1300830208](#) [1300840039](#) [1300900026](#) [1300990052](#) [1301740005](#) [1301800121](#) [1301800416](#) [1300830184](#) [1300990149](#) [1301580036](#)  
[1301720103](#) [1301720135](#) [1301720152](#) [1301720157](#) [1301740009](#) [1301770011](#) [1301850553](#) [1301860939](#) [1302000074](#) [1302264431](#)  
[1337706-2](#) [APA18-AK](#) [MTX6UTPSRC-C](#) [1-787307-1](#) [185491N001](#) [HP-6N](#) [C-202-C](#) [202C221-13-0](#) [OMTM-S10-C0](#) [205339-4](#) [CA7308-](#)  
[000](#) [8S23-75FR-CS8184](#) [2684](#) [9648](#) [3089](#) [988382-000](#) [A0270164](#)