

COMPACT MULTIPOLE CONNECTORS

 SERIES

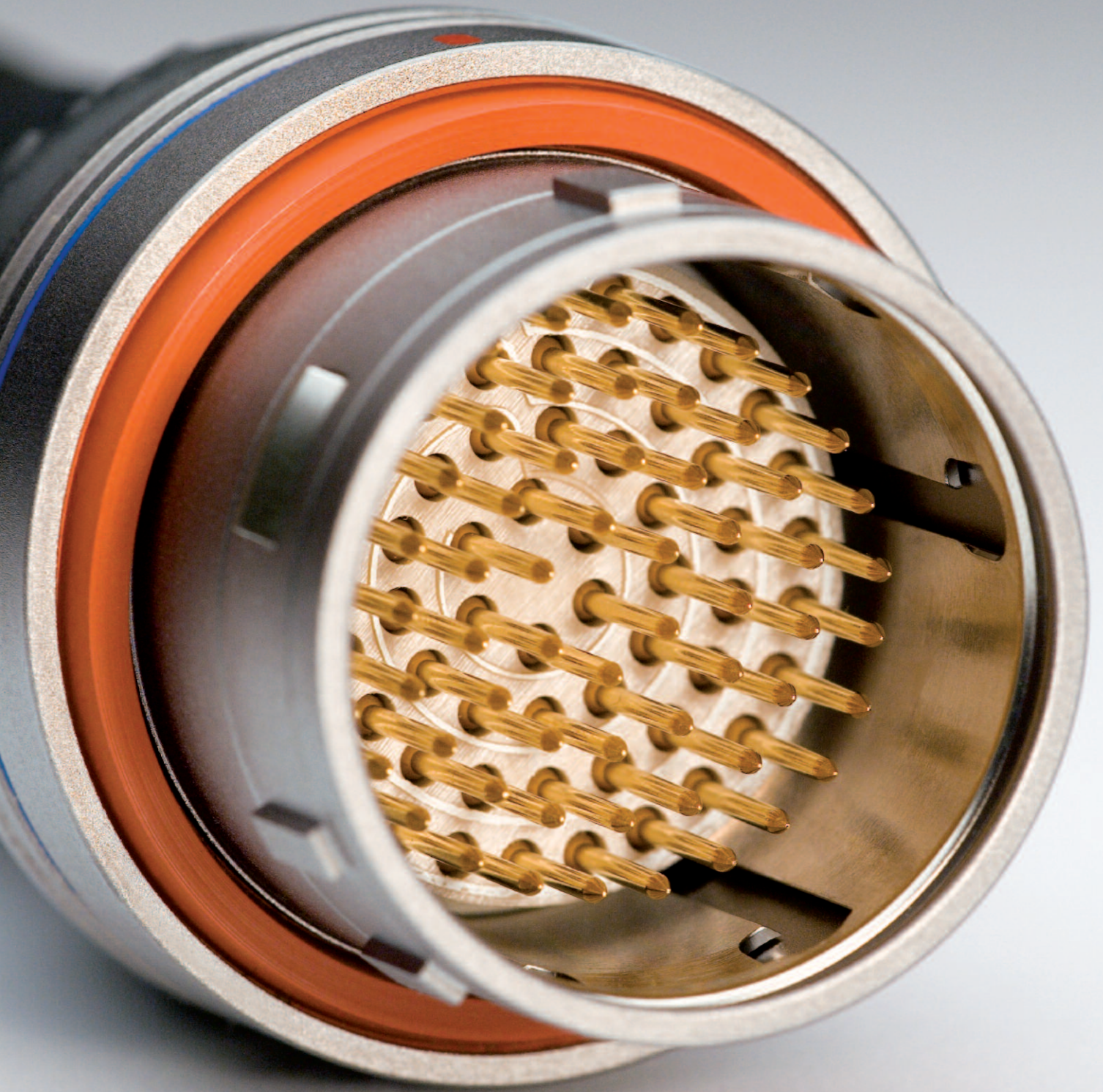

 **LEMO**[®]



No reproduction or use without express permission of editorial or pictorial content, in any manner.
LEMO reserve the right at all times to modify and improve specifications without any notification.

Table of Contents

	General production programme	page 2
	Main characteristics and types	2
	Series and types	3
	LEMO's push-pull self-latching connection system	4
	F series production program	4
	General characteristics	5
	Selection of shell materials, degrees of protection (IP code)	5
	Selection of contact types (crimp, print, fibre optic)	6
F Series	Interconnections	8
	Part numbering system	9
	Part section showing internal components	9
	Technical characteristics	10
	Metal housing models	11
	Watertight PCB models	15
	Models for Fibre Optic	16
	Alignment key	17
	Insert configuration	18
	Housings, contacts, cable fixing	20
	Variant	21
	LEMO F1 ECU systems connectors	22
Spare parts	Crimp contacts	24
	F7 fibre optic contacts	25
	Locking washers, hexagonal nuts, notched nuts	25
	Conical nuts	26
Accessories	Caps	28
	Heatshrink boot, insulating washers	29
Tooling	Spanners, taps, manual and pneumatic crimping tools	30
	Positioners, extractor for crimp contact	31
	Banding tool, retention testing tool	32
Fibre Optic Tooling	Complete workstation for F7 fibre optic contact	32
	Crimping tool, epoxy curing oven, polishing tool	32
	Fibre inspection microscope, microscope adaptor, F7 contact alignment device tool	33
Panel Cut-Outs	Mounting nut torque	33
PCB Drilling Pattern	Fixed socket with straight print contact	34
	Fixed socket with elbow print contact	35
Technical Characteristics	Outer shell	37
	Insulator	37
	Electrical contact	38
	Test voltage	39
	Rated current	40
	Assembly instructions	41
	Technical tables	42
	Product safety notice	44

General Production Programme

Connectors

- Unipole from 2 to 150 Amps
- Coaxial 50 and 75 Ω
- Coaxial 50 Ω (NIM-CAMAC)
- Coaxial 50 Ω for frequency → 12 GHz
- Multicoaxial 50 and 75 Ω
- Multipole from 2 to 68 contacts
- Multipole up to 106 contacts
- High Voltage 3, 5, 8, 10, 15, 30 and 50 kV cc
- Multi High Voltage 3, 5, and 10 kV cc
- Triaxial 50 and 75 Ω
- Quadrax
- Mixed: High Voltage (HV) + Low Voltage (LV)
- Mixed: Coax + LV and Triax + LV
- Thermocouple and multithermocouple
- Fibre optic singlemode and multimode
- Multi Fibre optic
- Mixed: fibre optic + LV
- Mixed: fibre optic + HV + LV
- Fluidic and Multifluidic
- Mixed: fluidic + LV
- Subminiature
- Miniature
- Sockets for printed circuit board
- Remote handling shell
- Watertight socket
- Hermaphroditic shell
- Rectangular connectors
- Sealed (pressure and/or vacuum) socket
- Plastic shell
- With aluminium outer shell
- With stainless steel outer shell
- With microswitch

Patch Panels All audio-video and HDTV applications

Adaptors For BNC, C, UHF, N, CINCH, GEN-RADIO connectors
For TNC, SMA connectors

Accessories Insulator for crimp contacts

- Crimp contacts
- Coaxial contacts
- Triaxial contacts
- Fibre optic contacts
- Fluidic contactss
- Caps
- Bend relief
- Heatshrink boot
- Washers
- Nuts

Tooling

- Assembly tool
- Crimping tools
- Positioners
- Extractors
- Banding tool
- Fibre optic termination workstation and tools

On request

- Connectors with special housing
- Special mixed configuration
- Custom design
- Assembly onto cable

- Connectors, accessories and tools found in this catalogue.

Main Characteristics and Types

Series	Standard 01 / 00 (unipole) 00 (NIM-CAMAC) 05 / R0 / 1D 0S to 6S 0A / 4A / 2C 1Y-3Y-6Y	Watertight 0E to 6E 3T 4M	Keyed 00 (multipole) 0B to 5B 2G / 5G	Keyed Watertight 0K to 5K 2N to 5N	Compact keyed FF to 5F	Hermaphroditic SH / MH	Rectangular RR / 0R / 1R	Screw 03 0V to 5V 0W to 5W 2U to 5U 0M-1M-2M
Latching	Push-Pull							Screw
Key	Stepped insert		Key (G) or other key-way code		Key (N) or other key-way code	Hermaphroditic shell	Key G or A	Key or stepped insert
Shell	Metal or plastic	Metal	Metal or plastic	Metal		Plastic	Metal	
Insert	Stepped insert or cylindrical		Cylindrical			Stepped insert	Rectangular	Stepped insert or cylindrical
Contact termination	Solder or print		Solder, crimp or print		Crimp or print	Solder, crimp or print	Crimp or print	Solder crimp or print
Contact type	Coaxial, triaxial, unipole, multipole HV, quadrax, fluidic, thermocouple		Multipole, fibre optic, HV, fluidic, thermocouple		Multipole, fibre optic		Multipole, HV, coaxial, fluidic	Multipole, coaxial, triaxial
Mixed config.	LV + coax, LV + HV		LV + coax, LV + triax, LV + HV, LV + FO, LV + fluidic		LV + FO		LV + coax, LV + HV, LV + fluidic	LV + coax, LV + triax, LV + FO, LV + fluidic

Series and Types

	Series	Types																				
		Unipole	Coaxial 50 Ω	Coaxial 75 Ω	Multipole	High Voltage	Triaxial 50 Ω	Triaxial 75 Ω	Quadrax	Multi HV	Multi Coaxial	Mixed HV+LV	Mixed Coax+LV	Mixed Triax+LV	Fibre Optic	Multi Fibre Optic	Mixed FO+LV	Fluidic	Multi fluidic	Mixed fluidic+LV	Thermocouple	
Standard	01		●																			
	00	●	●				●											●				
	05					●																
	R0		●																			
	0A		●	●																		
	0S	●	●		●	●	●															●
	1S	●	●	●	●	●	●															●
	2S	●	●	●	●	●	●	●				●										●
	3S	●	●	●	●	●	●			●												
	4S	●	●	●	●	●	●	●		●	●	●	●									
	5S	●	●	●	●					●	●	●	●									
	6S				●						●		●									
	1D								●													
	2C		●		●																	
4A							●															
1Y-3Y-6Y					●																	
Watertight	0E	●	●		●	●	●															●
	1E	●	●	●	●	●	●															●
	2E	●	●	●	●	●	●	●			●											●
	3E	●	●	●	●	●	●	●		●		●	●									
	4E	●	●	●	●	●	●	●				●	●									
	5E	●			●					●	●	●	●									
	6E				●						●		●									
	3T			●				●														
4M						●	●															
Keyed	00				●									●								●
	0B				●									●				●				●
	1B				●							●	●				●					●
	XB				●							●	●									●
	2B				●				●	●	●	●	●		●	●				●	●	●
	3B				●				●	●	●	●	●		●	●			●	●	●	●
	4B				●				●	●	●	●	●		●	●				●	●	●
	5B				●				●	●	●	●	●		●	●					●	●
	2G				●																	
5G								●														
Keyed watertight	0K				●									●								●
	1K				●						●	●	●				●					●
	2K			●	●				●	●	●	●	●		●	●				●	●	●
	3K			●	●				●	●	●	●	●		●	●			●	●	●	●
	4K				●				●	●	●	●	●		●	●				●	●	●
	5K				●				●	●	●	●	●		●	●				●	●	●
2N to 5N	●	●	●	●		●	●			●	●	●	●	●	●			●	●	●	●	
Compact keyed	FF				●																	
	0F				●																	
	1F				●																	
	2F				●										●	●						
	3F				●																	
	4F				●																	
LF				●																		
5F				●																		
Hermaphroditic	SH-MH				●										●	●						
Rectangular	RR				●																	
	0R				●						●	●										●
	1R				●						●	●										●
Screw	03		●		●																	
	0V to 5V	●	●	●	●		●	●				●										
	0W to 5W				●					●		●	●		●	●					●	●
	2U to 5U				●					●		●	●		●	●						
	0M-1M-2M				●																	

Note: ● = included in this catalogue, ● = available but not included in this catalogue.

LEMO's Push-Pull Self-Latching Connection System

This self-latching system is renowned worldwide for its easy and quick mating and unmating features. It provides absolute security against vibration, shock or pull on the cable, and facilitates operation in a very limited space.

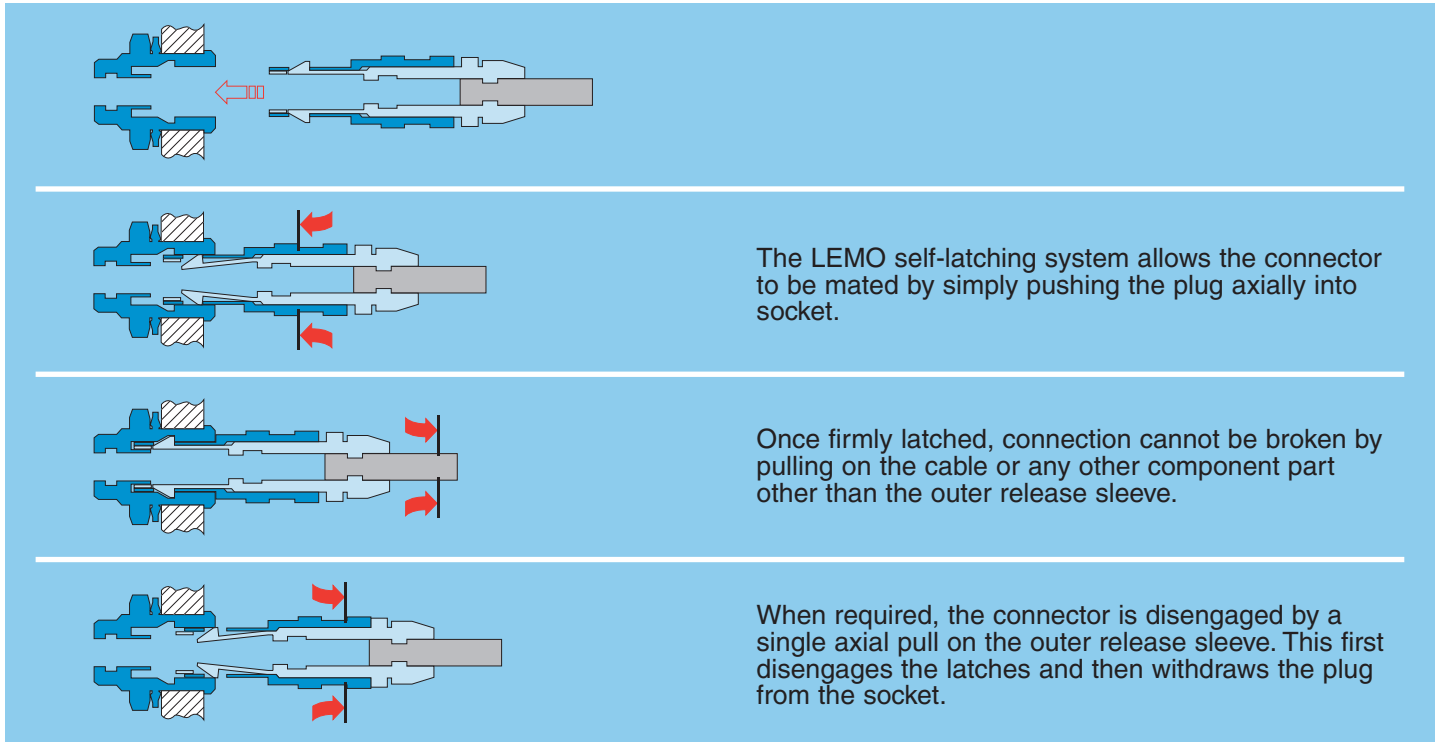

F Series Production Programme

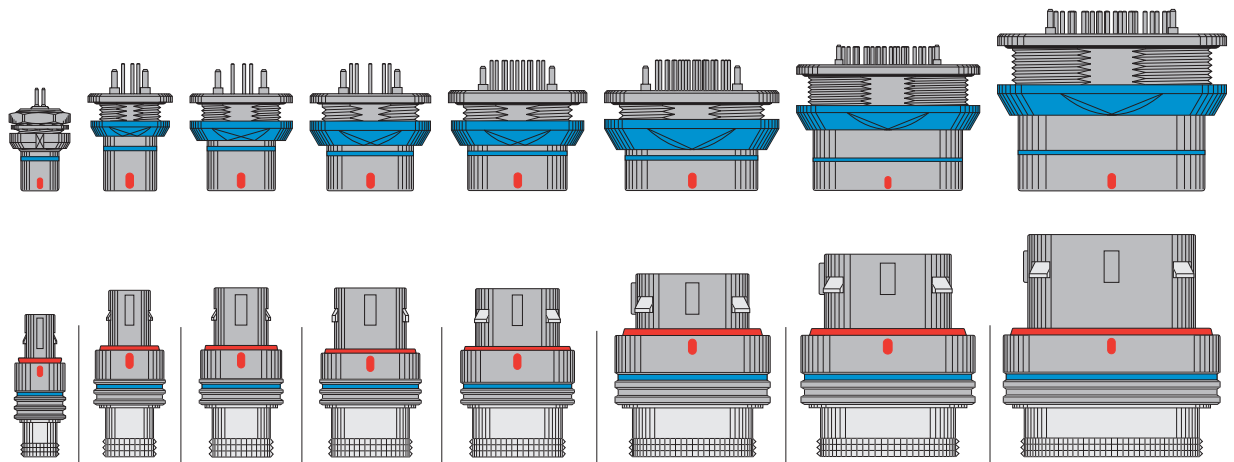

Series		FF	0F	1F	2F	3F	4F	LF	5F
Cable Ø range (mm)	min.	2.2	3.8	3.8	3.8	3.8	5.3	6.3	7.4
	max.	9	11	13	16	18	25	27	34
Number of LV contacts		3, 4	2, 3, 4, 5	3, 5, 7, 8	4, 8, 10, 12, 19	22, 30	40	68	50, 55, 64, 66
Nr of FO contacts ¹⁾	multi	-	-	-	2	-	-	-	-
	mixed	-	-	-	2 + 4 LV	-	-	-	-

Note: ¹⁾ For cable ranging from 3.6 to 6.5 mm in diameter.

General Characteristics

Selection of shell materials

Aluminium alloy

The aluminium alloy outer shells find numerous applications where light weight is a predominant factor; such as in the aeronautics and space industries, and for portable and mobile equipment.

Shells are made of high mechanical strength alloy (Aluminium alloy). Connector shells are protected by a conductive anthracite grey coloured nickel finish.

As a standard latch sleeve are made of special bronze or brass, this material offer excellent performances for most of the applications.

For very demanding vibrating situation we recommend the use of special latch sleeve in beryllium copper alloy. These parts have an electrolytic nickel plating.

As a standard gaskets are made of fluororubber FPM/FKM. This material has excellent resistance to hydrocarbons.

Sealing resin

An epoxy resin is used to seal both watertight and vacuumtight socket and coupler models.

Brass

The brass outer shells have a chrome nickel-plated surface which ensures very good protection against industrial atmosphere, salt air and most corrosive agents.

In case of brass shell standard latch sleeves are made of special bronze or brass.

Here standard gaskets are made of silicone rubber MQ/MVQ. This material has excellent weather resistance and a wide temperature range.

Other metallic components

In general, most metallic components are manufactured in brass. However, bronze or beryllium copper are used where good elasticity is required (for example: earthing crown). Depending on the application, these parts have electrolytic nickel plating.

Degrees of protection (IP code)

IEC 60529 outlines an international classification system for the sealing effectiveness of enclosures of electrical equipment against the intrusion into the equipment of foreign bodies (i.e., tools, dust, fingers) and moisture. This classification system utilizes the letters «IP» (Ingress Protection) followed by two digits.

Example: IP 64 = IP 6 4

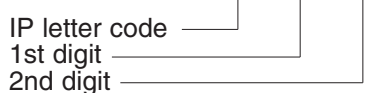

Degrees of protection - First digit

The first digit of the IP code indicates the degree that persons are protected against contact with moving parts and the degree that equipment is protected against solid foreign bodies intruding into an enclosure.

- 0 No special protection
- 1 Protection from a large part of the body such as hand or from solid objects greater than 50 mm in diameter
- 2 Protection against objects not greater than 80 mm in length and 12 mm in diameter
- 3 Protection from entry by tools, wires, etc., with a diameter or thickness greater than 2.5 mm
- 4 Protection from entry by solid objects with a diameter or thickness greater than 1.0 mm
- 5 Protection from the amount of dust that would interfere with the operation of the equipment
- 6 Dust-tight

Degrees of protection - Second digit

Second digit indicates the degree of protection of the equipment inside the enclosure against the harmful entry of various forms of moisture (e.g. dripping, spraying, submersion, etc.)

- 0 No special protection
- 1 Protection from vertically dripping water
- 2 Protection from dripping water when tilted up to 15°
- 3 Protection from sprayed water
- 4 Protection from splashed water
- 5 Protection from water projected from a nozzle
- 6 Protection against heavy seas, or powerful jets of water
- 7 Protection against temporary immersion
- 8 Protection against complete continuous submersion in water

UL Recognition

LEMO connectors are recognized by the Underwriters Laboratories (UL). The approval of the complete system (LEMO connector, cable and your equipment) will be easier because LEMO connectors are recognized.

RoHS

LEMO connector specifications conforms the requirements of the RoHS directive (2011/65/EU) of the European Parliament and the latest amendments. This directive specifies the restrictions of the use of hazardous substances in electrical and electronic equipment marketed in Europe.

Selection of contact types

Crimp contacts

The crimp contacts are designed to be crimped with the standard four indent method according to MIL-C-22520F, class 1, type 1.

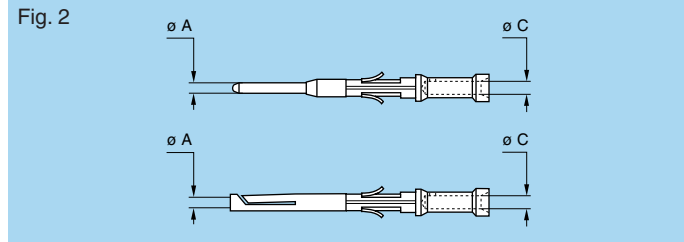
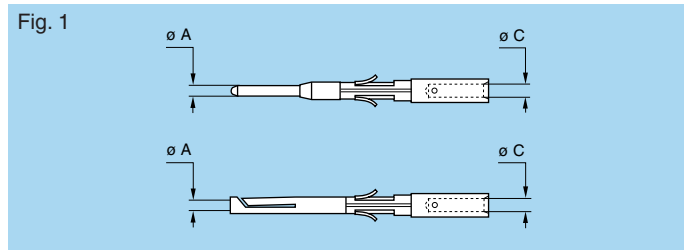

A detailed range of conductor dimensions that can be crimped into our contacts is given on the table at right. See also the section on tooling (pages 30 to 33).

Contacts are provided in two forms: with a standard crimp barrel for large conductors (see fig. 1), or with a reduced crimp barrel for smaller conductors (see fig. 2).

Contact			Conductor stranded				F_r (N)
ϕA (mm)	ϕC (mm)	Form per fig.	AWG stranded		Section (mm ²)		
			min.	max.	min.	max.	
0.5	0.42	1	32	28 ¹⁾	0.035	0.09	12
0.7	0.80	1	26	22 ¹⁾	0.140	0.34	22
0.9	1.10	1	24	20	0.250	0.50	30
1.3	1.40	1	20	18	0.500	1.00	40

Contact			Conductor stranded				F_r (N)
ϕA (mm)	ϕC (mm)	Form per fig.	AWG stranded		Section (mm ²)		
			min.	max.	min.	max.	
0.7	0.45	2	32	28	0.035	0.09	22
0.9	0.80	2	26	22 ¹⁾	0.140	0.34	30
	0.45	2	32	28	0.035	0.09	
1.3	1.10	2	24	20	0.250	0.50	40

Note: F_r = mean contact retention force in the insulator (according to IEC 60512-8 test 15a).

Note: ¹⁾ for a given AWG, the diameter of some stranded conductor designs is larger than the solder cup diameter. Make sure that the maximum conductor diameter is smaller than ϕC .

Print contacts

Print contacts are available in straight or elbow versions for certain connector types. Connection is possible by soldering on flexible or rigid printed circuit boards. Straight print contacts are gold-plated which guarantees optimum soldering, even after longterm storage.

Print elbow contacts include a tinned copper wire crimped into a contact.

L dimensions and C ϕ are detailed in the section on model description (elbow: L = 2 mm).

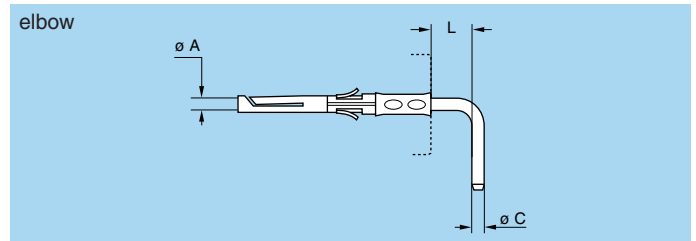
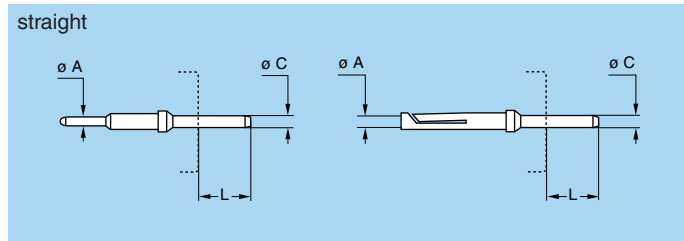

Fibre Optic contacts

The new miniature F7 fibre optic contact is available for use with single-mode or multi-mode fibres of the following sizes; 9/125, 50/125 and 62.5/125 microns. Contacts are designed with the IEC standard 1.25 mm diameter ceramic ferrules. After mounting on the cable, the

contact is very easily installed in the connector insulator, the particular shape of the contact body retains it in the insulator. The alignment tube can be easily removed in order to clean the fibre end face.

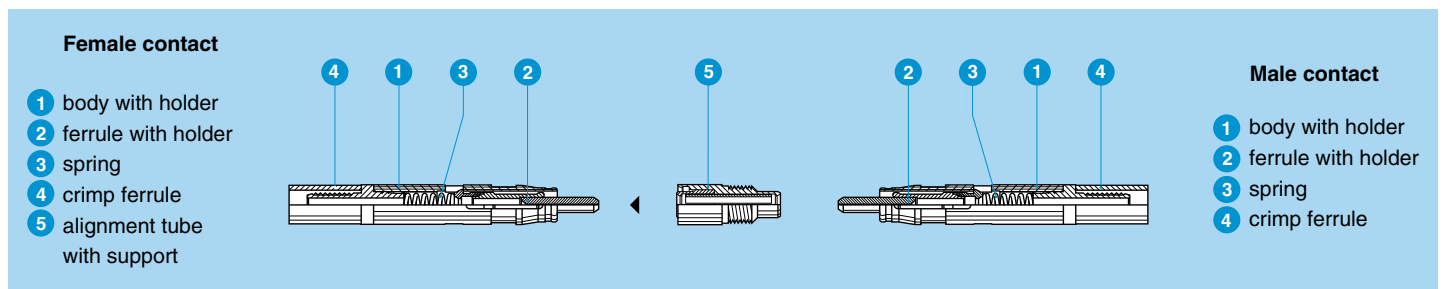

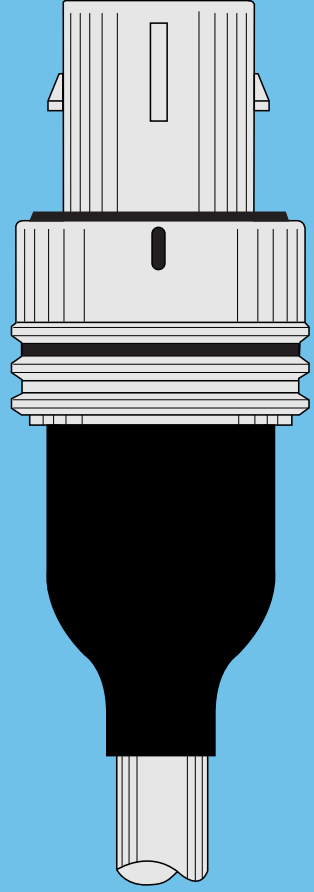
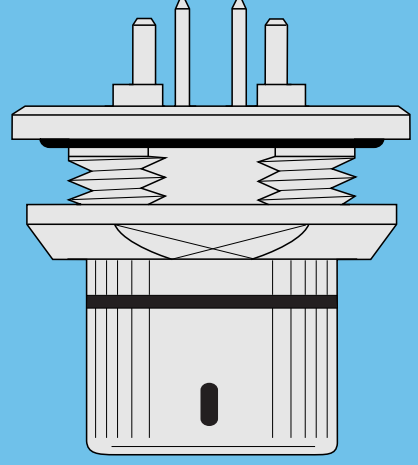

F SERIES

F Series

The F series connectors have been specially developed to meet the most demanding requirements in terms of dimensions, weight and watertightness. Our manufacturing programme includes now 8 series. This series provides customers with many features and benefits including:

- push-pull self-latching system for safe connection
- sealed to IP67 for environmental protection when mated according to IEC 60529
- compact scoop-proof design and use of aluminium alloy
- high shock and vibration resistance
- multipole types with 2 to 68 contacts or multifibre optic or mixed FO + LV in 2F series
- crimp or print contacts (straight or elbow)
- keys ensuring ease of blind mating
- colour coded key options for system security.

The F series connectors are available in 3 different materials:

- for high shock and vibration resistance, LEMO recommends using Y code material (with beryllium copper latch sleeve).
- for environmental resistance and latching cycle endurance, LEMO recommends using the C code material (brass outershell).
- for lightweight and latching cycle endurance, LEMO recommends using X code material (aluminium shell).
- for lightweight and salt spray corrosion resistance, LEMO recommends using I code material (aluminium shell).

Each series includes several models of plugs and sockets available in contact configurations adapted to all round cables, including up to 68 conductors, and a maximum diameter of 34 mm. Since LEMO connectors are perfectly screened and designed to guarantee very low resistance to shell electrical continuity, they are particularly adapted to applications where electromagnetic compatibility (EMC) is important. A large number of accessories as well as tooling for cable assembly are available.

Metal housing models (page 11)

Straight plugs

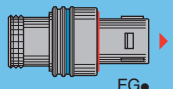

FG●

Fixed sockets

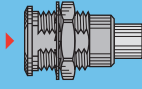

EG●

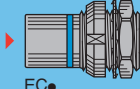

EC●

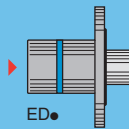

ED●

Fixed sockets

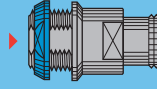

PE●

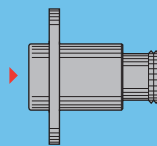

PB●

Free socket

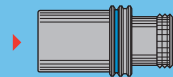

PH●

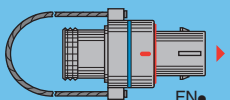

FN●

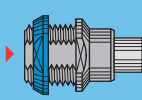

EE●

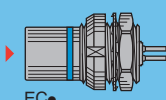

EC●

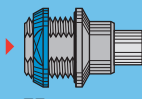

EF●

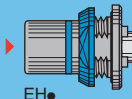

EH●

Models for fibre optic (page 16)

Straight plug

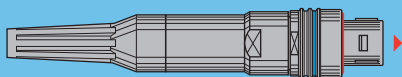

FG●

Fixed socket

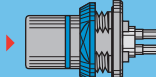

EH●

Watertight models (page 15)

Fixed sockets

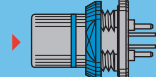

HE●

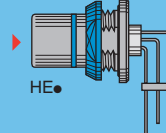

HE●

Technical Characteristics

Materials and Treatments

Component	Shell material code				Material (Standard)	Surface treatment (µm)			Notes	
	I	X	Y	C		chrome	nickel			gold
							I	X		
Outer shell					Brass (UNS C 38500)	0.3	-	-	-	
					Aluminium alloy (AA 6262A or AA 6023)	-	14	5	-	1)4)5)6)
Conical nut					Brass (UNS C 38500)	0.3	-	-	-	
					Aluminium alloy (AA 6262A or AA 6023)	anodized various colour				2)
Notched nut					Brass (UNS C 38500)	0.3	-	-	-	3)
					Aluminium alloy (AA 6262A or AA 6023)	-	14	5	-	1)3)6)
Earthing crown					Bronze (UNS C 54400) or special brass	-	3	3	-	
Latch sleeve					Special bronze/brass	-	3	3	-	
Locking washer					Beryllium Copper (UNS C 17300)	-	3	3	-	
Hexagonal nut					Bronze (UNS C 52100)	-	3	3	-	
					Brass (UNS C 38500)	-	3	3	-	
Other metallic components					Aluminium alloy (AA 6262A or AA 6023)	anodized natural				
					Brass (UNS C 38500)	-	0.5	3	-	
Male crimp contact					Brass (UNS C 34500)	-	-	-	1.0	
Female crimp contact					Bronze (UNS C 54400)	-	-	-	1.5	
Clips					Cu-Be or special steel	without treatment				
Insulator					PEEK	-				
O-ring and gaskets					FPM/FKM (Viton®)	-				
					Silicone MQ/MVQ	-			7)	
Sealing resin					Epoxy (Araldite® or Stycast®)	-				
Cable rear seal					Fluorosilicone	-				

Notes: standards for surface treatment are as follows: chrome-plated SAE AMS 2460; nickel-plated SAE AMS QQ N 290 or MIL DTL 32119; gold-plated ISO 27874. 1) anthracite colour. 2) the colour match the colour code of the key (see page 17). 3) for the FF series only. 4) FF series available only with material code Y. 5) LF and 5F series available only with material code X. 6) Nickel Teflon® - NiCorAI™ treatment (500 hours salt spray corrosion resistant). 7) Silicone gasket are available as a variant for code material X and Y.

Mechanical and Climatical

Characteristics	Value	Standard	Series / Shell material
Endurance	1000 cycles	IEC 60512-5 test 9a	All; code X
Endurance	300 cycles (FF and 0F); 500 cycles (1F to 3F)	IEC 60512-5 test 9a	All; code Y
Endurance	5000 cycles	IEC 60512-5 test 9a	All; code C
Humidity	up to 95% at 60° C		All
Operating temperature	-15° C, +200° C		All; code X or Y
Operating temperature	-55° C, +200° C		All; code C
Vibration resistance	10-2000 Hz, 15 g	IEC 60512-4 test 6d	All
Vibration (Gunfire test)	pass	MIL-standard 810 F	4F, LF and 5F; all materials
Vibration (Gunfire test)	pass	MIL-standard 810 F	FF, 0F, 1F, 2F, 3F; code Y
Vibration (ECU profile)	pass	See diagram below	FF, 0F, 1F, 2F; code Y
Shock resistance	100 g, 6 ms	IEC 60512-4 test 6c	All
Salt spray corrosion test	96 h	IEC 60512-6 test 11f	All; code X or Y
Salt spray corrosion test	500 h	IEC 60512-6 test 11f	All; code I
Salt spray corrosion test	1000 h	IEC 60512-6 test 11f	All; code C
Protection index (mated)	IP67 (select HE● model only for device protection)	IEC 60529	All
Climatical category	15/200/21	IEC 60068-1	All; code X or Y
Climatical category	50/175/21	IEC 60068-1	All; code C

Electrical

Insulation resistance IEC 60512-2 test 3a		Value	Shell electrical continuity IEC 60512-2 test 2f						Value
new	1)		FF-0F	1F	2F-3F	4F	LF	5F	
> 10 ¹²	> 10 ¹⁰	Ω	5.0	3.0	2.5	2.0	1.5	1.5	mΩ

Contact resistance 2) IEC 60512-2 test 2a				Value
0.5	0.7	0.9	1.3	
≤ 8.7	≤ 6.1	≤ 4.8	≤ 3.6	∅ A (mm) mΩ

Notes:

1) after humidity test: 21 days at 95% RH according to IEC 60068-2.

2) after 5000 mating cycles and the salt spray test according to IEC 60512-6 test 11 f.

Vibration (ECU profile)

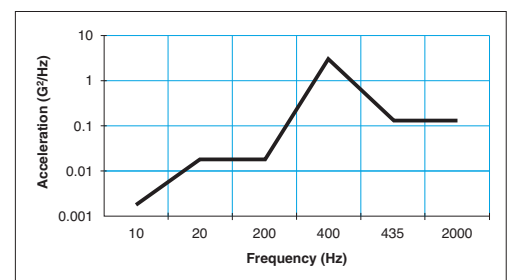

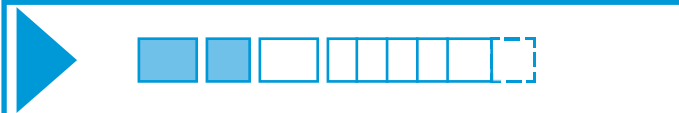

Models

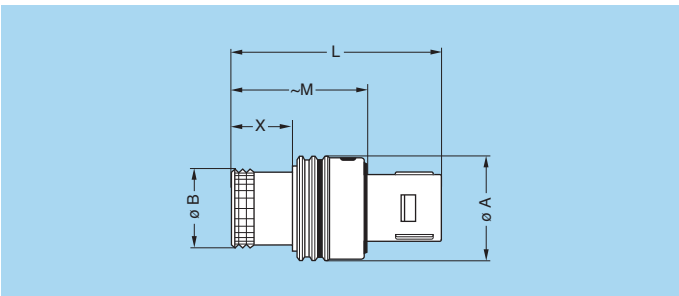

FG● Straight plug, key (N) or keys (P, S, T, W and X)

Reference		Dimensions (mm)				
Model	Series	A	B	L	M	X
FG●	FF	8.5	6.3	21.6	13.8	5.7
FG●	0F	12.0	9.0	27.5	17.8	8.0
FG●	1F	14.0	10.7	27.8	17.9	8.0
FG●	2F	17.0	14.0	27.8	17.9	8.0
FG●	3F	19.0	16.0	27.8	17.9	8.0
FGW	4F	26.0	21.2	30.3	20.4	8.0
FGX	4F	26.0	21.2	30.7	20.4	8.0
FGW	LF	29.0	24.2	34.7	20.4	8.0
FGX	LF	29.0	24.2	34.7	20.4	8.0
FG●	5F	36.1	30.2	36.7	20.4	8.0

Note: this plug can also be supplied with a reduced unlatching force (see page 9).

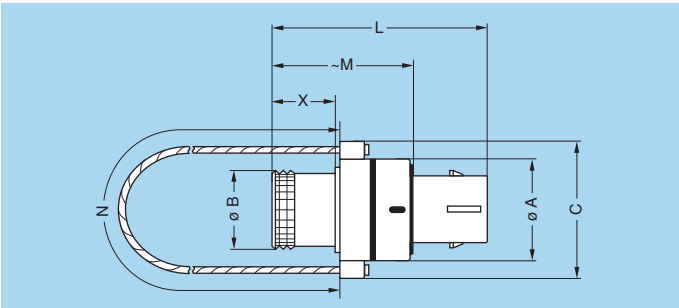
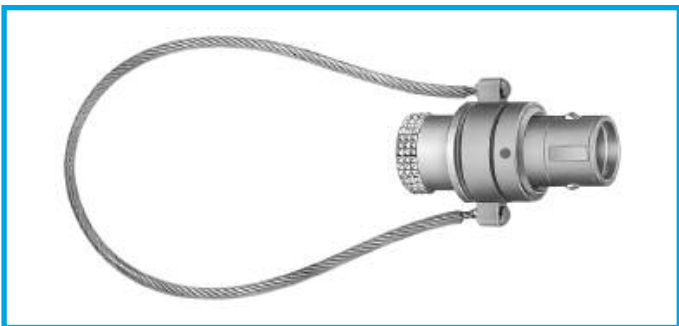

FN● Straight plug, key (N) or keys (P and S) and lanyard release

Reference		Dimensions (mm)						
Model	Series	A	B	C	L	M	N	X
FN●	0F	12.0	9.0	18.0	27.5	17.8	140	8.0
FN●	1F	14.0	10.7	20.0	27.8	17.9	140	8.0
FN●	2F	17.0	14.0	23.0	27.8	17.9	160	8.0
FN●	3F	19.0	16.0	25.0	27.8	17.9	190	8.0

Note: cable material: stainless steel with protective sheath

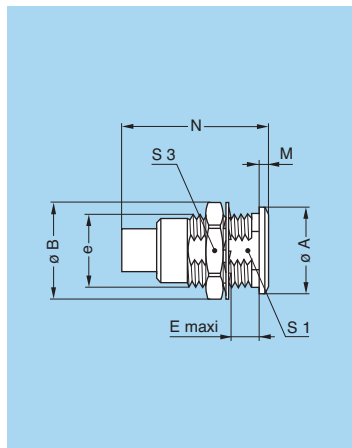

EG● Fixed socket, nut fixing, key (N) or keys (P, S and T), IP50

Reference		Dimensions (mm)								
Model	Series	A	B	e	E	M	N	S1	S3	
EG●	0F	10	12.4	M9x0.6	7.0	1.2	19.0	8.2	11	
EG●	1F	14	15.8	M12x1.0	6.5	1.5	19.0	10.5	14	
EG●	2F	18	19.2	M15x1.0	6.5	1.8	19.0	13.5	17	
EGN	3F	22	25.0	M18x1.0	5.5	2.0	19.0	16.5	22	
EGP	3F	22	25.0	M18x1.0	5.5	2.0	19.0	16.5	22	
EGS	3F	22	25.0	M18x1.0	5.5	2.0	20.5	16.5	22	
EGT	3F	22	25.0	M18x1.0	5.5	2.0	20.5	16.5	22	

Panel cut-out (page 33)

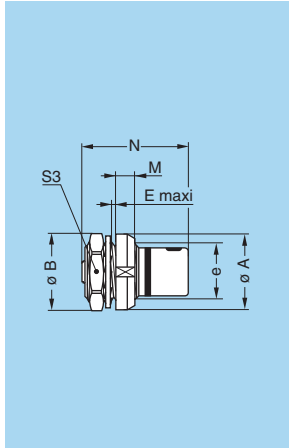

EC● Fixed socket with 2 nuts, key (N) or key (S), protruding shell, IP50 (back panel mounting)

Reference		Dimensions (mm)						
Model	Series	A	B	e	E	M	N	S3
EC●	FF	10	10.2	M7x0.5	1.5	2.5	13.9	9

Panel cut-out (page 33)

Note: this socket can be used without the hexagonal nut. It can be directly fastened into the device, the notched nut is used as a tightening nut.

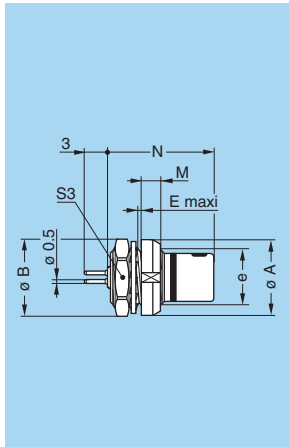

EC● Fixed socket with 2 nuts, key (N) or key (S), protruding shell, print contacts, IP50 (back panel mounting)

Reference		Dimensions (mm)						
Model	Series	A	B	e	E	M	N	S3
EC●	FF	10	10.2	M7x0.5	1.5	2.5	13.9	9

Panel cut-out (page 33)

Note: this socket can be used without the hexagonal nut. It can be directly fastened into the device, the notched nut is used as a tightening nut.

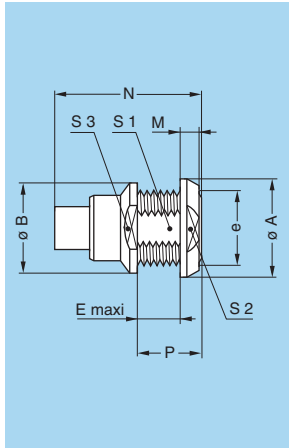

EE● Fixed socket, nut fixing, key (N) or keys (P, S and T), IP50 (back panel mounting)

Reference		Dimensions (mm)									
Model	Series	A	B	e	E	M	N	P	S1	S2	S3
EE●	0F	13	12	M10x0.75	6.0	2.5	19.0	8.5	9.0	11	10.5
EE●	1F	17	15	M13x0.75	6.2	3.2	19.0	9.4	11.5	14	14.0
EE●	2F	20	19	M16x1.00	6.4	4.0	19.0	10.4	14.5	17	16.0
EEN	3F	22	22	M18x1.00	6.4	4.0	19.0	10.4	16.5	19	20.0
EEP	3F	22	22	M18x1.00	6.4	4.0	19.0	10.4	16.5	19	20.0
EES	3F	22	22	M18x1.00	6.4	4.0	20.5	10.4	16.5	19	20.0
EET	3F	22	22	M18x1.00	6.4	4.0	20.5	10.4	16.5	19	20.0

Panel cut-out (page 33)

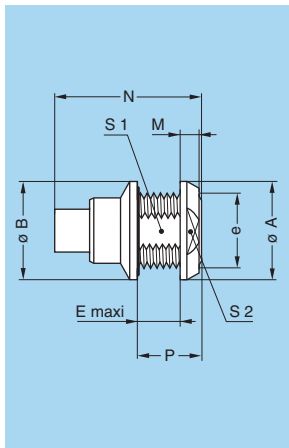

EF● Fixed socket, nut fixing, key (N) or keys (P, S and T), (back panel mounting)

Reference		Dimensions (mm)									
Model	Series	A	B	e	E	M	N	P	S1	S2	
EF●	1F	17	17	M13x0.75	6.2	3.2	19.0	9.4	11.5	14	

Panel cut-out (page 33)

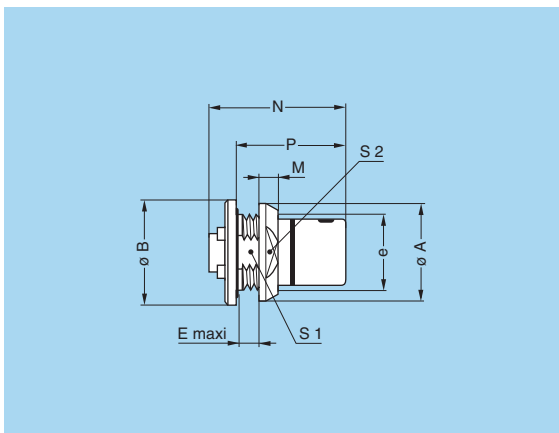

EH● Fixed socket, nut fixing, key (N) or keys (P, S, T, W and X), (back panel mounting)

Reference		Dimensions (mm)									
Model	Series	A	B	e	E	M	N	P	S1	S2	
EH●	FF	10	11	M7x0.50	3.0	2.5	15.0	12.0	6.4	8	
EH●	0F	13	14	M10x0.75	3.0	2.5	19.0	14.5	9.0	11	
EH●	1F	17	17	M13x0.75	3.0	3.2	19.0	14.5	11.5	14	
EH●	2F	20	20	M16x1.00	3.0	4.0	19.0	14.5	14.5	17	
EHN	3F	22	23	M18x1.00	3.0	4.0	19.0	14.5	16.5	19	
EHP	3F	22	23	M18x1.00	3.0	4.0	19.0	14.5	16.5	19	
EHS	3F	22	23	M18x1.00	3.0	4.0	20.5	16.0	16.5	19	
EHT	3F	22	23	M18x1.00	3.0	4.0	20.5	16.0	16.5	19	
EHW	4F	29	29	M24x1.00	3.0	5.0	19.0	14.5	22.0	25	
EHX	4F	29	29	M24x1.00	3.0	5.0	21.0	16.5	22.0	25	
EHW	LF	32	32	M27x1.00	6.4	5.0	24.3	20.0	25.0	28	
EHX	LF	32	32	M27x1.00	6.4	5.0	24.3	20.0	25.0	28	
EH●	5F	38	38	M33x1.00	6.4	5.0	28.4	24.0	31.0	34	

Panel cut-out (page 33)

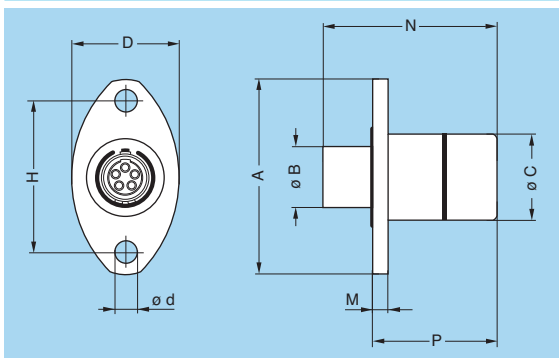

ED● Fixed socket with flange, key (N) or keys (P and S), 2 holes fixing, protruding shell

Reference		Dimensions (mm)								
Model	Series	A	B	C	d	D	H	M	N	P
ED●	1F	25.4	5.9	11.5	3.5	14	19.3	2	19	16.5

Panel cut-out (page 33)

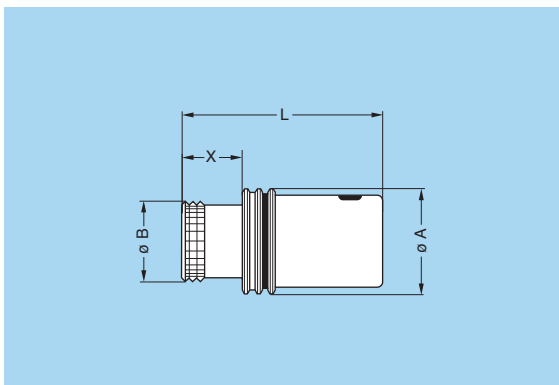

PH● Free socket, key (N) or keys (P, S, T, W and X)

Reference		Dimensions (mm)			
Model	Series	A	B	L	X
PH●	FF	8.5	6.3	20.7	5.7
PH●	0F	12.0	9.0	26.7	8.0
PH●	1F	14.0	10.7	26.7	8.0
PH●	2F	17.0	14.0	26.7	8.0
PHN	3F	19.0	16.0	26.7	8.0
PHP	3F	19.0	16.0	26.7	8.0
PHS	3F	19.0	16.0	28.2	8.0
PHT	3F	19.0	16.0	28.2	8.0
PHW	4F	26.0	21.2	26.7	8.0
PHX	4F	26.0	21.2	28.7	8.0
PHW	LF	29.0	24.2	32.2	8.0
PHX	LF	29.0	24.2	32.2	8.0
PH●	5F	35.0	30.2	37.2	8.0

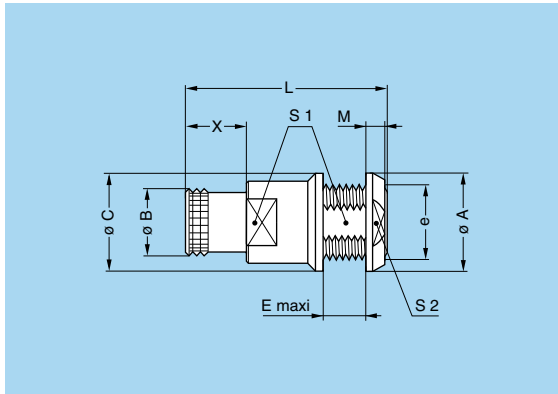

PE● Fixed socket, nut fixing, key (N) or keys (P, S, T, W and X), (back panel mounting)

Reference		Dimensions (mm)									
Model	Series	A	B	C	e	E	L	M	S1	S2	X
PE●	FF ¹⁾	10	6.3	11	M7x0.50	6.0	20.7	2.5	6.4	—	5.7
PE●	0F	13	9.0	13	M10x0.75	6.0	26.7	2.5	9.0	11	8.0
PE●	1F	17	10.7	17	M13x0.75	6.2	26.7	3.2	11.5	14	8.0
PE●	2F	20	14.0	20	M16x1.00	6.4	26.7	4.0	14.5	17	8.0
PEN	3F	22	16.0	22	M18x1.00	6.4	26.7	4.0	16.5	19	8.0
PEP	3F	22	16.0	22	M18x1.00	6.4	26.7	4.0	16.5	19	8.0
PES	3F	22	16.0	22	M18x1.00	6.4	28.2	4.0	16.5	19	8.0
PET	3F	22	16.0	22	M18x1.00	6.4	28.2	4.0	16.5	19	8.0
PEW	4F	29	21.2	29	M24x1.00	6.4	26.7	5.0	22.0	25	8.0
PEX	4F	29	21.2	29	M24x1.00	6.4	28.7	5.0	22.0	25	8.0
PEW	LF	32	24.2	32	M27x1.00	6.4	32.2	5.0	25.0	28	8.0
PEX	LF	32	24.2	32	M27x1.00	6.4	32.2	5.0	25.0	28	8.0
PE●	5F	38	30.2	38	M33x1.00	6.4	37.2	5.0	31.0	34	8.0

Panel cut-out (page 33)

Note: ¹⁾ fitted with notched nut GEG.

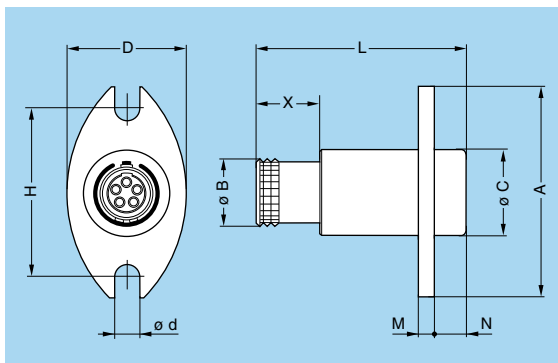
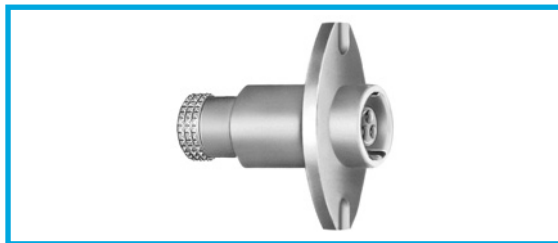

PB● Fixed socket with flange, key (N) or keys (P, S, T, W and X), 2 holes fixing

Reference		Dimensions (mm)									
Model	Series	A	B	C	d	D	H	L	M	N	X
PB●	0F	27	9.0	11.0	3.2	15	21.4	26.7	2	4	8
PB●	1F	27	10.7	13.0	3.2	15	21.4	26.7	2	4	8
PB●	2F	31	14.0	16.0	3.2	18	25.9	26.7	2	4	8
PBN	3F	38	16.0	17.5	3.2	20	29.0	26.7	2	4	8
PBP	3F	38	16.0	17.5	3.2	20	29.0	26.7	2	4	8
PBS	3F	38	16.0	17.5	3.2	20	29.0	28.2	2	4	8
PBT	3F	38	16.0	17.5	3.2	20	29.0	28.2	2	4	8
PBW	4F	41	21.2	23.0	3.2	26	32.0	26.7	2	4	8
PBX	4F	41	21.2	23.0	3.2	26	32.0	28.7	2	4	8
PB●	5F	44	30.2	32.0	3.2	33	38.2	37.2	2	4	8

Panel cut-out (page 33)

▶ Watertight PCB models

HEN fixed sockets allow the device on which they are fitted to reach a protection index of IP68 as per IEC 60529 (unmated). These models are identified by a letter «P» at the end of the reference. Epoxy resin is used to seal these models. They can be mated with all plugs of the same series to achieve an IP67 protection index between the plug and socket.

Technical Characteristics

Mechanical and Climatical

Characteristics ¹⁾	Value	Standard	Series / Shell material
Temperature range	-15° C, +100° C		All; code I, X or Y
Temperature range	-50° C, +150° C		All; code C or variant with silicone gasket final code (S)
Protection index unmated	IP68	IEC 60529	All
Maximum operating pressure ²⁾	5 bars	IEC 60512-7 test 14d	All

Note: ¹⁾ see also page 10. ²⁾ this value corresponds to the maximum allowed pressure difference for the assembled socket.

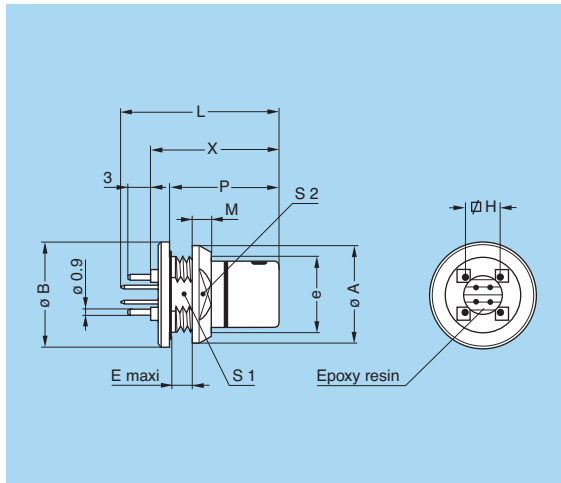
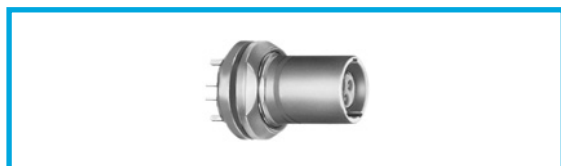

HE● Fixed socket, nut fixing, key (N) or keys (P, S, T, W and X), for printed circuit, (back panel mounting)

Reference		Dimensions (mm)										
Model	Series	A	B	e	E	H	L	M	P	S1	S2	X
HE●	FF ¹⁾	10	11	M7x0.50	3.0	5.08	18.2	2.5	12.0	6.4	8.2	15.0
HE●	0F	13	14	M10x0.75	3.0	5.08	21.5	2.5	14.5	9.0	11.0	17.5
HE●	1F	17	17	M13x0.75	3.0	7.62	21.5	3.2	14.5	11.5	14.0	17.5
HE●	2F	20	20	M16x1.00	3.0	8.89	21.5	4.0	14.5	14.5	17.0	17.5
HEN	3F ²⁾	22	23	M18x1.00	3.0	11.43	21.5	4.0	14.5	16.5	19.0	17.5
HEP	3F ²⁾	22	23	M18x1.00	3.0	11.43	21.5	4.0	14.5	16.5	19.0	17.5
HES	3F ²⁾	22	23	M18x1.00	3.0	11.43	23.0	4.0	16.0	16.5	19.0	19.0
HET	3F ²⁾	22	23	M18x1.00	3.0	11.43	23.0	4.0	16.0	16.5	19.0	19.0
HEW	4F	29	29	M24x1.00	3.0	15.24	21.5	5.0	14.5	22.0	25.0	17.5
HEX	4F	29	29	M24x1.00	3.0	15.24	23.5	5.0	16.5	22.0	25.0	19.5
HEW	LF	32	32	M27x1.00	6.4	16.51	26.3	5.0	20.0	25.0	28.0	23.5
HEX	LF	32	32	M27x1.00	6.4	16.51	26.3	5.0	20.0	25.0	28.0	23.5
HE●	5F	38	38	M33x1.00	6.4	20.32	32.2	5.0	24.0	31.0	34.0	27.4

Panel cut-out (page 33)

PCB drilling pattern (page 34)

Note: ¹⁾ fitted with notched nut GEG.

²⁾ for chrome plated version (material code «C»), A = 24 mm and S2 = 20 mm.

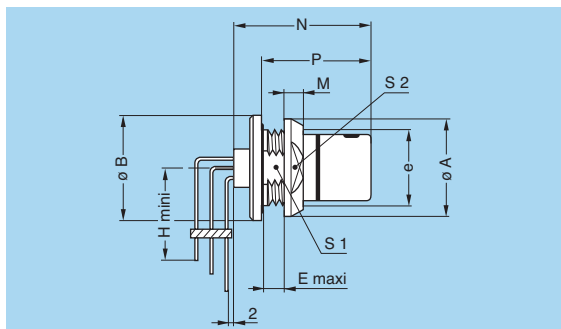
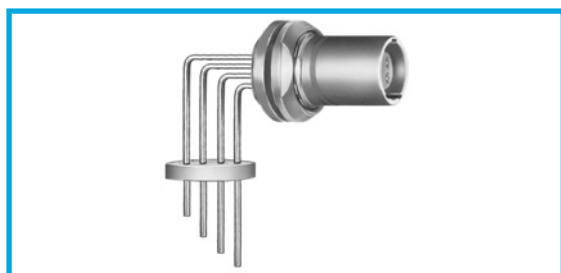

HE● Fixed socket, nut fixing, key (N) or key (P), with elbow (90°) contacts for printed circuit, (back panel mounting)

Reference		Dimensions (mm)									
Model	Series	A	B	e	E	H	M	N	P	S1	S2
HE●	0F	13	14	M10x0.75	3.0	20	2.5	18.5	14.5	9.0	11
HE●	1F	17	17	M13x0.75	3.0	20	3.2	18.5	14.5	11.5	14
HE●	2F	20	20	M16x1.00	3.0	20	4.0	18.5	14.5	14.5	17

Panel cut-out (page 33)

PCB drilling pattern (page 35)

Models for Fibre Optic

The 2F series has also been designed to allow fibre optic transmissions. This compact connector uses our F7 fibre optic contact but requires a specific plug with extended shell (T-adapter). The main features are:

- Multi fibre option with 2 optical contacts
- Mixed option with 2 FO + 2 LV contacts
- Optical contact with ceramic ferrules diameter 1.25 mm

Technical Characteristics of optical contacts

Mechanical and Climatical

Characteristic	Value	Standard
Mating durability	> 1000 cycles	IEC 61300-02-02
Damp heat steady state	up to 93 % RH at 40°C	IEC 61300-02-19
High temperature	+85°C	IEC 61300-02-18
Low temperature	-40°C	IEC 61300-02-17
Cable retention	100 N	IEC 61300-02-04
Vibration (3 axes)	100 to 2000 Hz, 2 hrs	-
Change of temperature	-40 to +75°C	IEC 61300-02-22
Temperature/humidity	-10 to +65°C at 93 % RH	IEC 61300-02-21

Optical

Characteristic	Value	Standard	Method
Average insertion loss fibre 9/125 µm	0.18 dB	IEC 61300-03-34	Method 2
Average insertion loss fibre 50/125 µm	0.25 dB	IEC 61300-03-34	Method 2
Return loss fibre 9/125 µm (UPC)	≥45 dB	IEC 61300-03-06	Coupler Method
Return loss fibre 9/125 µm (Hand polish)	>25 dB	IEC 61300-03-06	Coupler Method

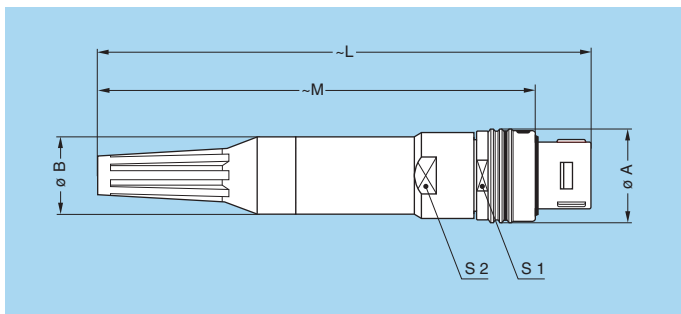
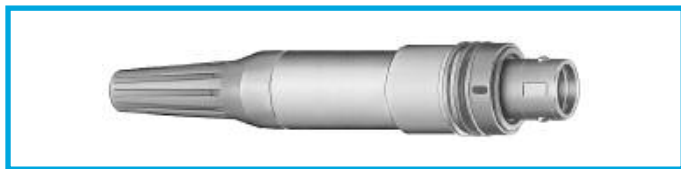

FG● Straight plug, key (N) or keys (P and S)

Reference		Dimensions (mm)					
Model	Series	A	B	L	M	S1	S2
FG●	2F	17.0	14.0	89.5	79.5	15.0	14.0

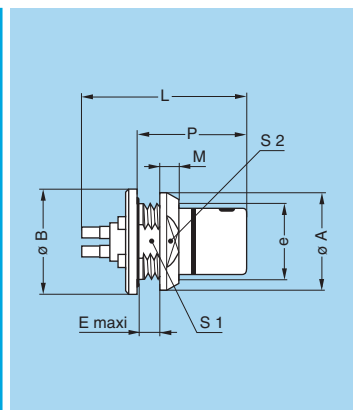

EH● Fixed socket, nut fixing, key (N) or keys (P and S), (back panel mounting)

Reference		Dimensions (mm)								
Model	Series	A	B	e	E	L	M	P	S1	S2
EH●	2F	20	20	M16x1	3	21.8	4	14.5	14.5	17

Panel cut-out (page 33)

Note: Other models of socket can be made available.

Connectors for fibre-optic are delivered without the fibre optic contacts, they must be ordered separately (see page 25). For T-type cable adapter see page 20.

Alignment Key

Alignment Key and Polarized Keying System

F series connector model part numbers are composed of three letters. The LAST LETTER indicates the keys corresponding to a particular contact type. For example, straight plugs with N, P or W keys, are fitted with male contacts; whereas with S, T or X keys, plugs are fitted with female contacts. Sockets with N, P or W keys, are fitted with female contacts; whereas with S, T or X keys, sockets are fitted with male contacts.











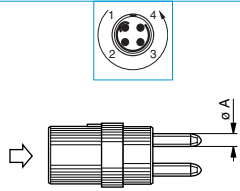
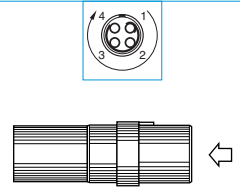



















Front view of a socket 	Model	Nb of keys	Series FF		Series 0F to 2F		Series 3F		Colour code	Contact type Electrical or Optical		Note
			Angles							Plug	Socket	
			β	γ	β	γ	β	γ				
●●N	3	165°	30°	165°	30°	150°	60°	blue	male	female	●	
●●P		–	–	150°	60°	145°	70°	yellow	male	female	○	
●●S		155°	50°	155°	50°	140°	80°	red	female	male	●	
●●T		–	–	160°	40°	135°	90°	green	female	male	○	

Front view of a socket 	Model	Nb of keys	Series 4F-LF-5F				Colour code	Contact type		Note
			Angles					Plug	Socket	
			α	β	γ	δ				
●●W	5	95°	115°	35°	25°	blue	male	female	●	
●●X		100°	125°	40°	20°	red	female	male	○	

● First choice alternative ○ Special order alternative

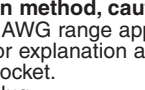
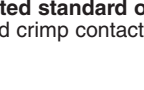
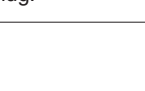
Insert configuration

Multipole

	 Male crimp contacts		 Female crimp contacts		Reference	Number of contacts	ø A (mm)	Contact type			AWG ²⁾	Test voltage (kV rms) ¹⁾ Contact-contact	Test voltage (kV rms) ¹⁾ Contact-shell	Rated current (A) ¹⁾
	Crimp	Print (straight)	Print (elbow)											
FF					303	3	0.5	●	●	–	28-30-32	1.35	1.10	3.0
					304	4	0.5	●	●	–	28-30-32	1.05	1.05	2.0
0F					302	2	0.9	●	●	●	20-22-24	1.45	1.20	10.0
					303	3	0.9	●	●	●	20-22-24	1.70	1.60	8.0
					304	4	0.7	●	●	●	22-24-26	1.35	1.10	7.0
					305	5	0.7	●	●	●	22-24-26	1.25	1.20	6.5
1F					303	3	1.3	●	●	●	18-20	1.60	1.85	12.0
					305	5	0.9	●	●	●	20-22-24	1.30	1.55	9.0
					307	7	0.7	●	●	●	22-24-26	1.45	1.45	7.0
					308	8	0.7	●	●	●	22-24-26	1.30	1.30	5.0
2F					304	4	1.3	●	–	–	18-20	2.70	1.85	15.0
					308	8	0.9	●	●	●	20-22-24	1.95	1.95	10.0
					310	10	0.9	●	●	●	20-22-24	1.80	2.10	8.0
					312	12	0.7	●	●	●	22-24-26	1.65	2.00	7.0
					319	19	0.7	●	●	●	22-24-26	1.55	1.65	5.0
3F					322	22	0.7	●	●	–	22-24-26	1.70	1.45	5.5
					330	30	0.7	●	●	–	22-24-26	1.35	1.20	3.5
4F					340	40	0.7	●	●	–	22-24-26	1.35	1.30	2.0

Note: Other types available on request, based on existing contact configurations of the B series.

1) see calculation method, caution and suggested standard on pages 39 and 40.

2) the mentioned AWG range apply to the standard crimp contact of fig.1. Contacts with reduced crimp barrel are available for smaller conductor.







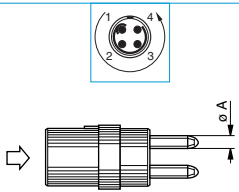
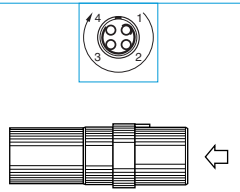

See page 20 for explanation and availability.

3) view for EHS socket.

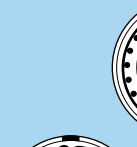
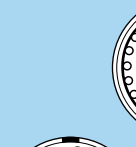
4) view for FGS plug.

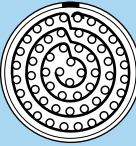

Multipole

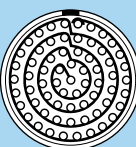



	 Male crimp contacts	 Female crimp contacts	Reference	Number of contacts	ø A (mm)	Contact type			AWG ⁽²⁾	Test voltage (kV rms) ⁽¹⁾ Contact-contact	Test voltage (kV rms) ⁽¹⁾ Contact-shell	Rated current (A) ⁽¹⁾
						Crimp	Print (straight)	Print (elbow)				
LF			368	68	0.7	●	●	–	22-24-26	1.5	1.5	2.5
5F			350	50	0.9	●	●	–	20-22-24	1.20	1.45	6.0
			355	55	0.9	●	●	–	20-22-24	2.00	2.10	5.0
			364	64	0.9	●	●	–	20-22-24	1.35	1.85	3.0
			366	66	0.9	●	●	–	20-22-24	1.30	1.80	3.0

Note: Other types available on request, based on existing contact configurations of the B series.

¹⁾ see calculation method, caution and suggested standard on pages 39 and 40.

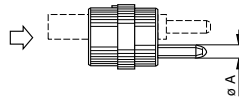
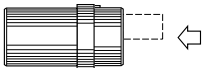
²⁾ the mentioned AWG range apply to the standard crimp contact of fig.1. Contacts with reduced crimp barrel are available for smaller conductor. See page 20 for explanation and availability.

Multi fibre and Mixed fibre optic + LV

	 Male crimp contacts	 Female crimp contacts	Reference	Fibre optic No	Contact No	ø A (mm)	Low Voltage contact			Rated current (A)
							Contact type	Crimp contact		
							Crimp	Test voltage (kV rms) ⁽¹⁾ Contact-contact	Test voltage (kV rms) ⁽¹⁾ Contact-shell	
2F			03A	2	–	–	–	–	–	–
			93B	2	4	0.7	●	0.85	1.25	6.0

Note: Other types available on request, based on existing contact configurations of the B series.

¹⁾ see calculation method, caution and suggested standard on pages 39 and 40.

²⁾ the mentioned AWG range apply to the standard crimp contact of fig.1. Contacts with reduced crimp barrel are available for smaller conductor. See page 20 for explanation and availability.

Housings

Ref.	Availability																Outer shell		Latch sleeve		Gaskets
	for plug								for sockets								Material	Surface treatment	Material	Surface treatment	
	FF	0F	1F	2F	3F	4F	LF	5F	FF	0F	1F	2F	3F	4F	LF	5F					
I	-	●	●	●	●	●	●	●	●	●	●	●	●	●	●	●	Aluminium alloy	NiCorAl	Special bronze/brass	NiCorAl	FPM/FKM
X	-	●	●	●	●	●	●	●	●	●	●	●	●	●	●	●	Aluminium alloy	Nickel ¹⁾	Special bronze/brass	Nickel	FPM/FKM
Y	●	●	●	●	●	●	-	-	-	-	-	-	-	-	-	-	Aluminium alloy	Nickel ¹⁾	Beryllium copper	Nickel	FPM/FKM
C	-	○	○	○	○	-	-	-	-	○	○	○	○	-	-	-	Brass	Chrome	Special bronze/brass	Nickel	Silicone MQ/MVQ

Note: ¹⁾ anthracite colour. See page 10 for detail on Material and Treatments. ● First choice alternative ○ Special order alternative

Contacts

Crimp contacts for plugs, free or fixed sockets

There are 2 forms of crimp barrels:
 – per fig. 1, the standard design
 – per fig. 2, with reduced crimp barrel for small conductors.

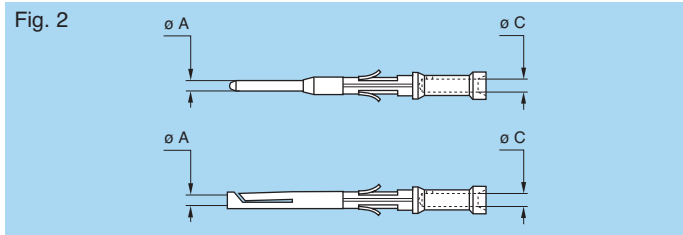
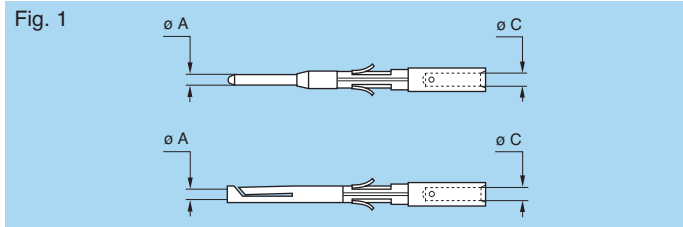

Ref.	Contact type	Ref.	Contact type
C	Male crimp (fig. 1)	M	Female crimp (fig. 1)
B	Male crimp (fig. 2)	P	Female crimp (fig. 2)
G	Male crimp (fig. 2)	U	Female crimp (fig. 2)
D	Male straight print	N	Female straight print
Z	No contact (for multi FO)	V	Male or female elbow print

Dimension of crimp barrels

Contact			Ref. contact type		Conductor			
ø A (mm)	ø C (mm)	Form per fig.	Male	Female	AWG		Section (mm ²)	
					min.	max.	min.	max.
0.5	0.42	1	C	M	32	28 ¹⁾	0.035	0.09
					26	22	0.140	0.34
0.7	0.80	1	C	M	32	28	0.035	0.09
					24	20	0.250	0.50
0.9	1.10	1	C	M	26	22	0.140	0.34
					32	28	0.035	0.09
1.3	1.40	1	C	M	20	18	0.500	1.00

Note: ¹⁾ for a given AWG, the diameter of some stranded conductor designs is larger than the solder cup diameter. Make sure that the maximum conductor diameter is smaller than ø C.

Cable Fixing

T type cable adapter

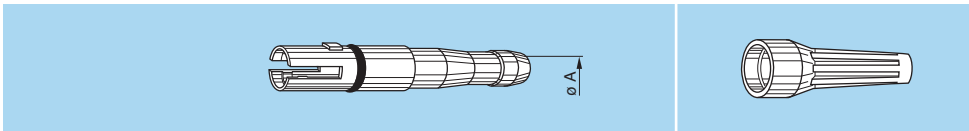

Reference	Adapter ø A	Cable ø		Adapter with gasket part number	Bend relief to be used ¹⁾
		max.	min.		
2F	T46Z	4.6	4.5 3.6	FGG.2F.846.TNV	GMA.2B.040.D●
	T56Z	5.6	5.5 4.6	FGG.2F.856.TNV	GMA.2B.050.D●
	T66Z	6.6	6.5 5.6	FGG.2F.866.TNV	GMA.2B.060.D●

Note: ¹⁾ to order separately.



Variant

Some options are available, they are identify with specific letters in the variant position.

- F apply to plug with a reduced unlatching force, such option allows disconnection if the cable is pulled accidentally.
- Connectors with code material I, X or Y are delivered with FPM/FKM gasket as a standard.
As an option they can be delivered with Silicone gasket. Add the «S» in the variant position.
- P indicated that the watertight models HE● are potted with epoxy resin.

Model	Reference			
	Reduced unlatching force	Silicone gasket	Potted	Potted and silicone gasket
FG●	F	S	-	-
E●●	-	S	-	-
HE●	-	-	P	PS

LEMO F1 ECU systems connectors

LEMO F Series connectors feature on the new ECU being provided by Microsoft® and McLaren Electronic Systems® for the FIA Formula One World Championship in 2008, 2009 and 2010.

The applications include the hub interface unit, lap trigger receiver, powerbox and display connections. To assist users, information on corresponding LEMO connectors that are required to connect to the system are described here below giving full part numbers and application.

LEMO connectors can also be ideally used for HIL setups (hardware in the loop), for vehicle electronic development, crash test setups, for ECU calibration and test, and also in battery status diagnosis.

LEMO connectors have full EMC screening and offer secure push-pull connections for Flexray, CAN bus or USB protocol, PWM (pulse width modulation), digital I/O and power supply.

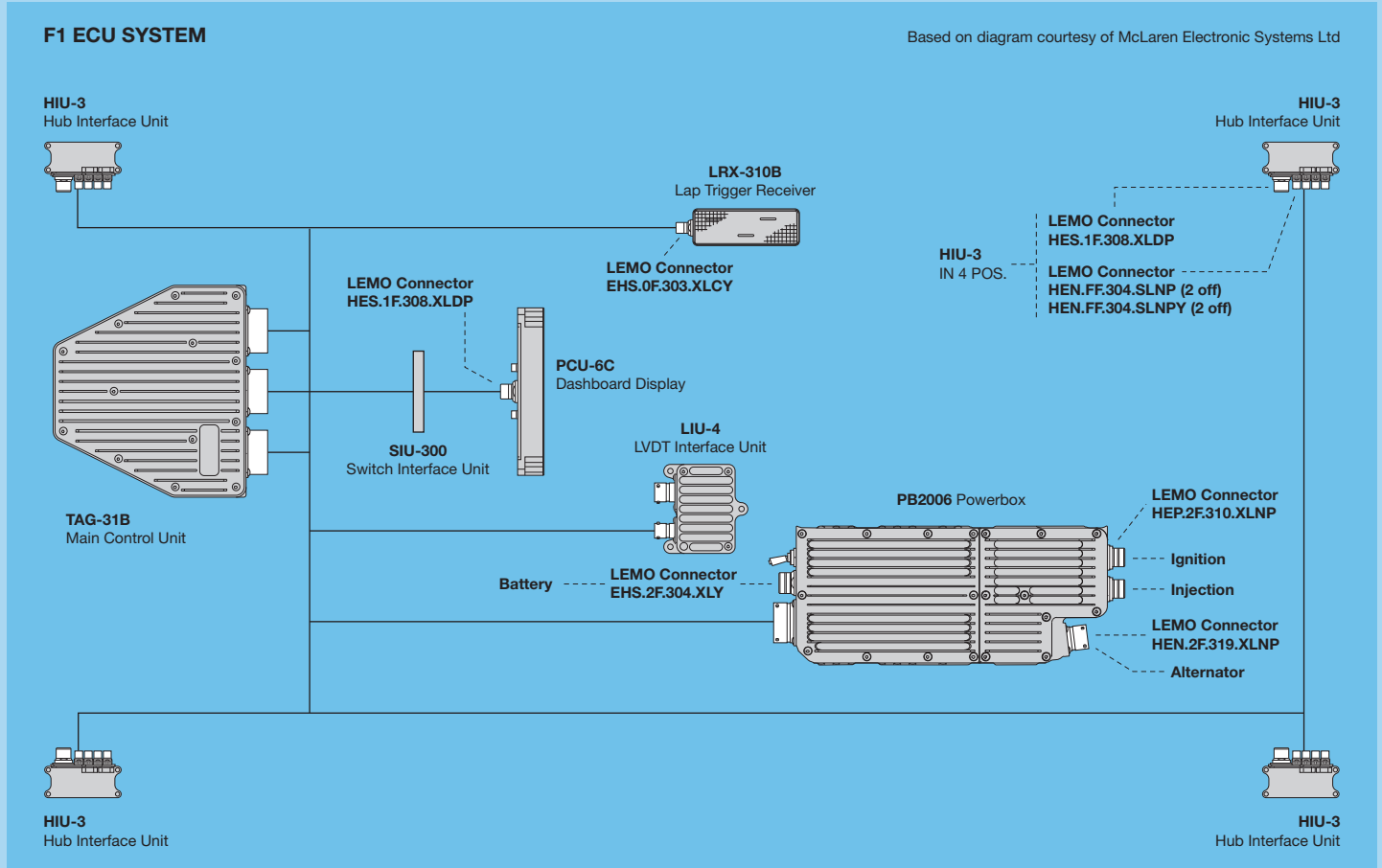

HIU (1, 2, 3 & 4) Hub Interface Unit

Unit connectors	Interface connectors	Spare contacts
HES.1F.308.XLDP	FGS.1F.308.YLM	EGG.0B.655.ZZM
HEN.FF.304.SLNP ¹⁾	FGN.FF.304.YLC	FGG.00.554.ZZC
HEN.FF.304.SLNPY ¹⁾	FGN.FF.304.YLC	FGG.00.554.ZZC

Notes: ¹⁾ outershell in stainless steel (AISI 303, 304).

LRX 310B Lap Trigger Receiver

Unit connector	Interface connector	Spare contact
EHS.0F.303.XLCY	FGS.0F.303.YLM	EGG.0B.660.ZZM

PB2006 Powerbox

Unit connectors	Interface connectors	Spare contacts
EHS.2F.304.XLY	FGS.2F.304.YLY	FGN.1F.565.ZZC ¹⁾ EGN.1F.665.ZZM ²⁾
HEP.2F.310.XLNP	FGP.2F.310.YLC	FGG.0B.560.ZZC
HEN.2F.319.XLNP	FGN.2F.319.YLC	FGG.0B.555.ZZC

Notes: ¹⁾ male contact. ²⁾ female contact.

PCU-6C Dashboard display

Unit connector	Interface connector	Spare contact
HES.1F.308.XLDP	FGS.1F.308.YLM	EGG.0B.655.ZZM

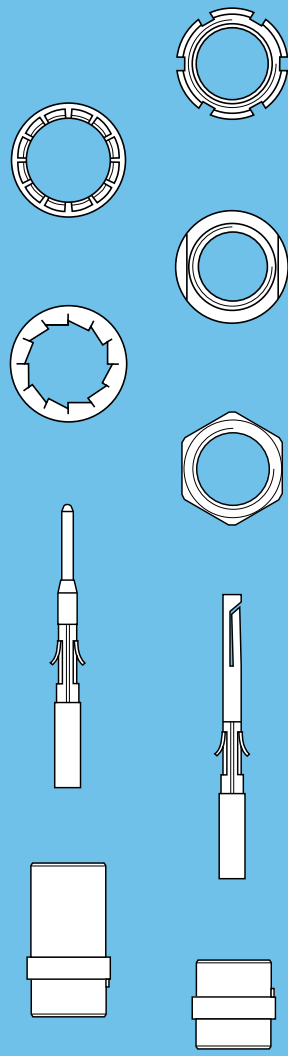

SPARE PARTS

Spare parts

FGG-EGG Crimp contacts

Fig. 1

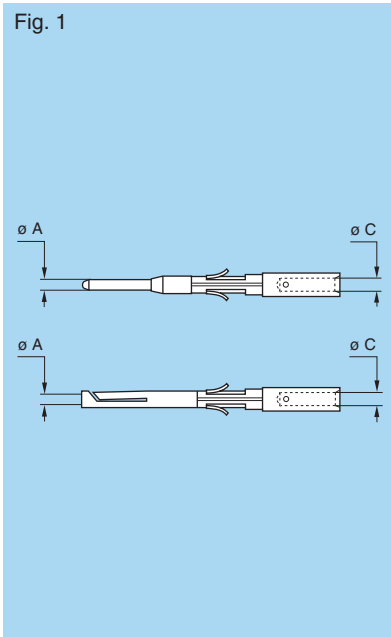

	Contact (mm)		Contact part number			
	ø A	ø C	male for plug	female for socket	male for socket	female for plug
FF	0.5	0.42	FGG.00.554.ZZC	EGG.00.654.ZZM	FGG.00.554.ZZC	EGG.00.654.ZZM
0F	0.9	1.10	FGG.0B.560.ZZC	EGG.0B.660.ZZM	FGG.0B.560.ZZC	EGG.0B.660.ZZM
	0.7	0.80	FGG.0B.555.ZZC	EGG.0B.655.ZZM	FGG.0B.555.ZZC	EGG.0B.655.ZZM
1F	1.3	1.40	FGN.1F.565.ZZC	EGN.1F.665.ZZM	FGN.1F.565.ZZC	EGN.1F.665.ZZM
	0.9	1.10	FGG.0B.560.ZZC	EGG.0B.660.ZZM	FGG.0B.560.ZZC	EGG.0B.660.ZZM
	0.7	0.80	FGG.0B.555.ZZC	EGG.0B.655.ZZM	FGG.0B.555.ZZC	EGG.0B.655.ZZM
2F	1.3	1.40	FGN.1F.565.ZZC	EGN.1F.665.ZZM	FGN.1F.565.ZZC	EGN.1F.665.ZZM
	0.9	1.10	FGG.0B.560.ZZC	EGG.0B.660.ZZM	FGG.0B.560.ZZC	EGG.0B.660.ZZM
	0.7	0.80	FGG.0B.555.ZZC	EGG.0B.655.ZZM	FGG.0B.555.ZZC	EGG.0B.655.ZZM
3F	0.7	0.80	FGG.0B.555.ZZC	EGG.0B.655.ZZM	FGG.0B.555.ZZC	EGN.3F.655.ZZM
4F	0.7	0.80	FGG.2B.555.ZZC	EGG.0B.655.ZZM	FGG.0B.555.ZZC	EGG.2B.655.ZZM
LF	0.7	0.80	FGG.3B.555.ZZC	EGG.2B.655.ZZM	FGG.0B.555.ZZC	EGG.3B.655.ZZM
5F	0.9	1.10	FGG.3B.560.ZZC	EGG.3B.660.ZZM	FGG.3B.560.ZZC	EGG.3B.660.ZZM

Fig. 2

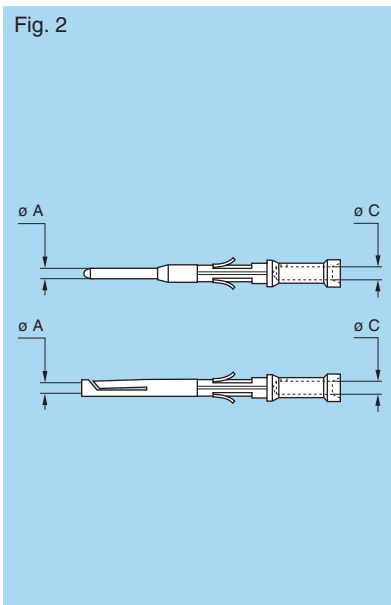

	Contact (mm)		Contact part number			
	ø A	ø C	male for plug	female for socket	male for socket	female for plug
0F	0.9	0.80	FGG.0B.561.ZZC	EGG.0B.661.ZZM	FGG.0B.561.ZZC	EGG.0B.661.ZZM
		0.45	FGG.0B.562.ZZC	EGG.0B.662.ZZM	FGG.0B.562.ZZC	EGG.0B.662.ZZM
	0.7	0.45	FGG.0B.556.ZZC	EGG.0B.656.ZZM	FGG.0B.556.ZZC	EGG.0B.656.ZZM
1F	0.9	0.80	FGG.0B.561.ZZC	EGG.0B.661.ZZM	FGG.0B.561.ZZC	EGG.0B.661.ZZM
		0.45	FGG.0B.562.ZZC	EGG.0B.662.ZZM	FGG.0B.562.ZZC	EGG.0B.662.ZZM
	0.7	0.45	FGG.0B.556.ZZC	EGG.0B.656.ZZM	FGG.0B.556.ZZC	EGG.0B.656.ZZM
2F	0.9	0.80	FGG.0B.561.ZZC	EGG.0B.661.ZZM	FGG.0B.561.ZZC	EGG.0B.661.ZZM
		0.45	FGG.0B.562.ZZC	EGG.0B.662.ZZM	FGG.0B.562.ZZC	EGG.0B.662.ZZM
	0.7	0.45	FGG.0B.556.ZZC	EGG.0B.656.ZZM	FGG.0B.556.ZZC	EGG.0B.656.ZZM
3F	0.7	0.45	FGG.0B.556.ZZC	EGG.0B.656.ZZM	FGG.0B.556.ZZC	EGN.3F.656.ZZM
4F	0.7	0.45	FGG.2B.556.ZZC	EGG.0B.656.ZZM	FGG.0B.556.ZZC	EGG.2B.656.ZZM
LF	0.7	0.45	FGG.3B.556.ZZC	EGG.2B.656.ZZM	FGG.0B.556.ZZC	EGG.3B.656.ZZM
5F	0.9	0.80	FGG.3B.561.ZZC	EGG.3B.661.ZZM	FGG.3B.561.ZZC	EGG.3B.661.ZZM

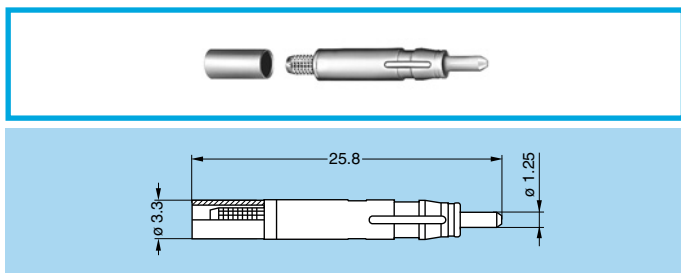

FFS.F7 Male F7 Fibre Optic Contact

Part number	Ferrule hole \varnothing (μm)	Fibre \varnothing core/cladding (μm)	Note
FFS.F7.125.LCE23	125	9/125	●
FFS.F7.126.LCE23	126	50/125	●
FFS.F7.128.LCE23	128	62.5/125	○

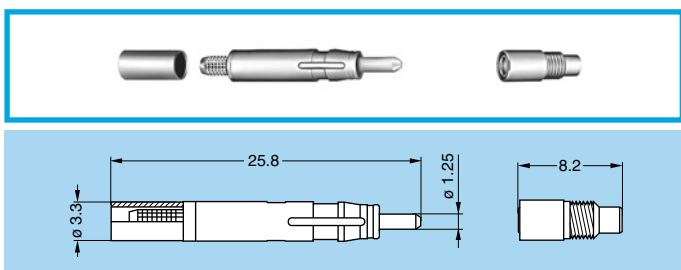

PSS.F7 Female F7 Fibre Optic Contact

Part number	Ferrule hole \varnothing (μm)	Fibre \varnothing core/cladding (μm)	Note
PSS.F7.125.LCE23	125	9/125	●
PSS.F7.126.LCE23	126	50/125	●
PSS.F7.128.LCE23	128	62.5/125	○

Note: alignment device part number: PSS.F7.290.NZZ

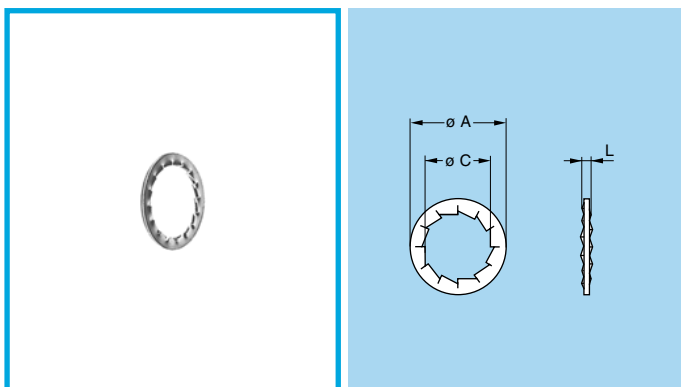

GBA Locking washers

Part number	Series	Dimensions (mm)			For models
		A	C	L	
GBA.00.250.FN	FF	9.5	7.1	1.0	EC●
GBA.0S.250.FN	0F	12.5	9.1	1.0	EG●
GBA.1S.250.FN	1F	16.0	12.1	1.0	EG●
GBA.2S.250.FN	2F	19.5	15.1	1.2	EG●
GBA.3S.250.FN	3F	25.0	18.1	1.4	EG●, PE●, EE●, EH●

Note: to order this accessory separately, use the above part numbers.

- Material: Nickel-plated bronze (3 μm)

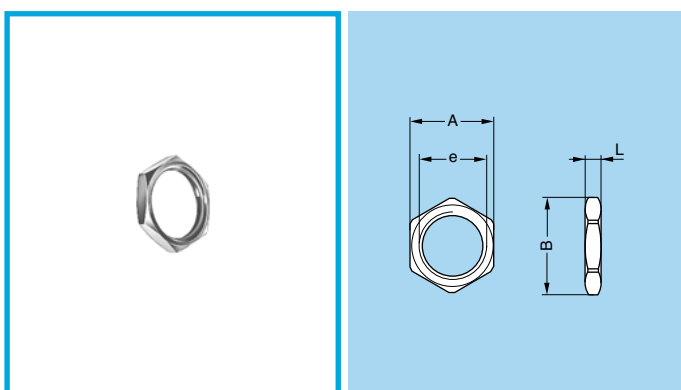

GEA Hexagonal nuts

Part number	Series	Dimensions (mm)				For models
		A	B	e	L	
GEA.00.240.LN	FF	9	10.2	M7x0.50	2.0	EC●
GEA.0S.240.LN	0F	11	12.4	M9x0.60	2.0	EG●
GEA.1S.240.LN	1F	14	15.8	M12x1.00	2.5	EG●
GEA.2S.240.LN	2F	17	19.2	M15x1.00	2.7	EG●
GEA.3S.240.LN	3F	22	25.0	M18x1.00	3.0	EG●

Note: to order this part separately use the above part numbers.

- Material: Nickel-plated brass (3 μm)

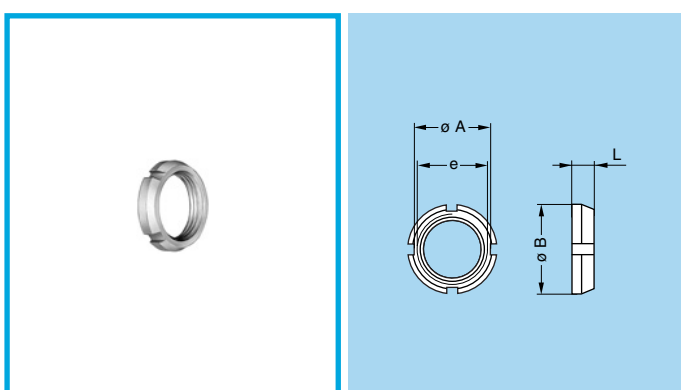

GEG Notched nut

Part number	Series	Dimensions (mm)				For models
		A	B	e	L	
GEG.00.240.RN	FF	8.7	10	M7x0.50	2.5	HE●, EC●, PE●

- Material: Nickel-anthracite aluminium alloy

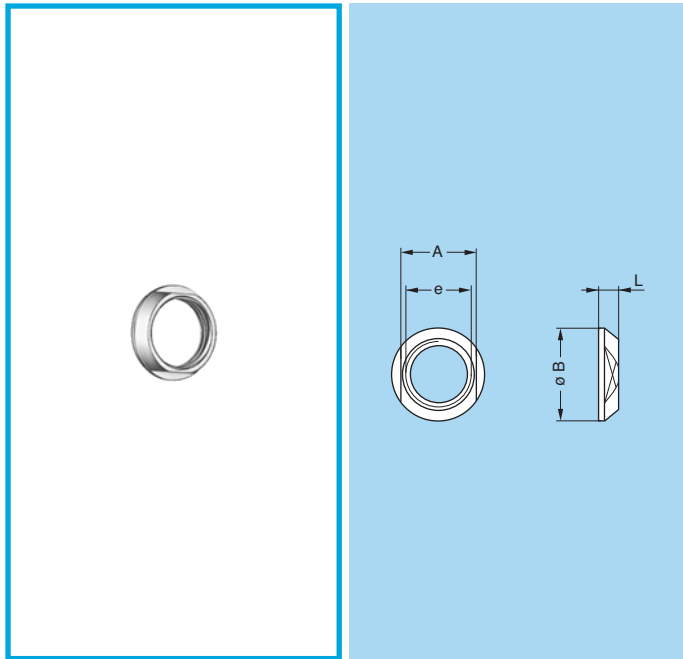

GEC Conical nut

Part number	Series	Dimensions (mm)				For models
		A	B	e	L	
GEC.FF.240.R●	FF	8	10	M7x0.50	2.5	PE●, EH●, HE●
GEC.0F.240.R●	0F	11	13	M10x0.75	2.5	PE●, EE●, EH●, HE●
GEC.1F.240.R●	1F	14	17	M13x0.75	3.2	PE●, EE●, EH●, HE●
GEC.2F.240.R●	2F	17	20	M16x1.00	4.0	PE●, EE●, EH●, HE●
GEC.3F.240.R●	3F	19	22	M18x1.00	4.0	PE●, EE●, EH●, HE●
GEC.4F.240.R●	4F	25	29	M24x1.00	5.0	PE●, EH●, HE●
GEC.LF.240.R●	LF	28	32	M27x1.00	5.0	PE●, EH●, HE●
GEC.5F.240.R●	5F	34	38	M33x1.00	5.0	PE●, EH●, HE●

Ref.	Colour	Keying
A	blue	N or W
J	yellow	P

Ref.	Colour	Keying
R	red	S or X
V	green	T

Note: the last position "●" of the part number indicates the colour. To obtain the required colour, refer to the above table and change the position "●" of the part number to the corresponding letter.

- Material: Anodized aluminium alloy

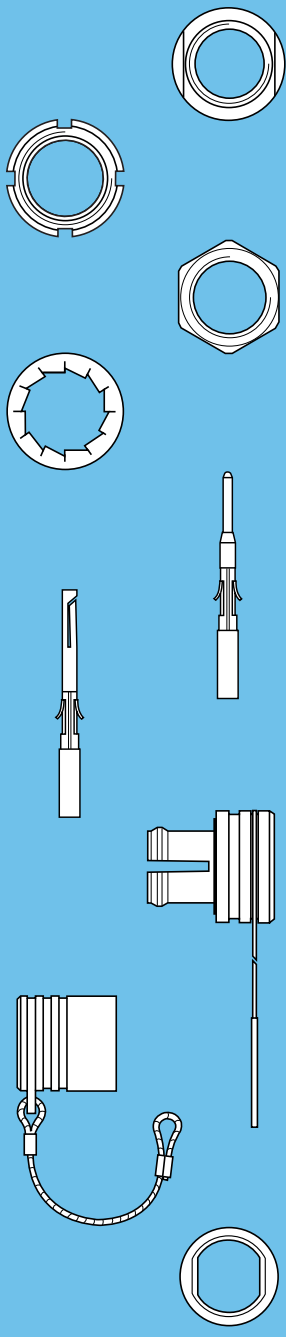

ACCESSORIES

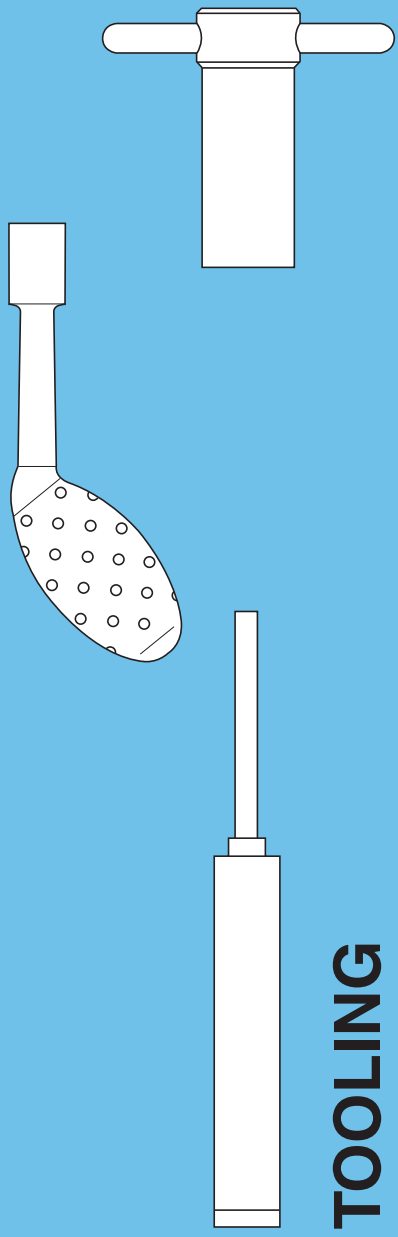

TOOLING

Accessories

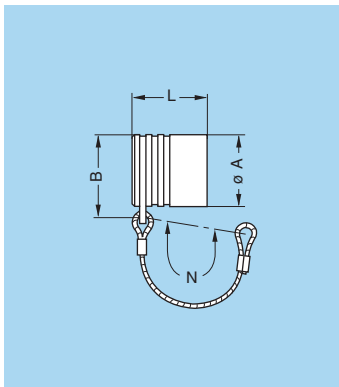

BF● Plug caps, with keys (N or P)

Part number	Series	Dimensions (mm)			
		A	B	L	N
BF●.1F.100.PCSG	1F	12.0	13.3	12.6	62
BF●.2F.100.PCSG	2F	15.0	16.4	12.8	75

- Body material: PA6.6 grey
- Cord material: Polyamide 6
- Maximum operating temperature: 100°C
- Protection index: IP51 according to IEC 60529

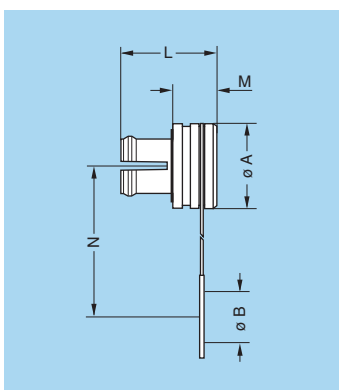

BRA Blanking caps for fixed sockets

Part number	Series	Dimensions (mm)				
		A	B	L	M	N
BRA.1F.200.PZSG	1F	14.0	13.7	12.1	5.3	65.5
BRA.2F.200.PZSG	2F	18.0	16.5	12.0	5.6	65.5

- Body material: PA6.6 grey
- Band: PET
- Maximum operating temperature: 100°C
- Protection index: IP51 according to IEC 60529

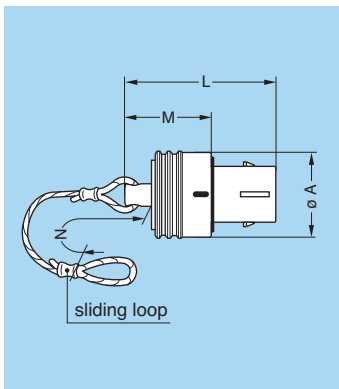

BRF Blanking caps, with latching for free sockets

Part number	Series	Dimensions (mm)			
		A	L	M	N
BRF.FF.200.YAV	FF	8.5	20.0	12.0	60
BRF.0F.200.XAV	0F	12.0	25.5	15.6	85
BRF.1F.200.XAV	1F	14.0	25.8	15.7	85
BRF.2F.200.XAV	2F	17.0	25.8	15.6	85
BRF.3F.200.XAV	3F	19.0	27.8	17.6	120
BRF.4F.200.XAV	4F	26.0	30.3	20.1	120
BRF.LF.200.XAV	LF	29.0	34.7	20.1	120

Note: this cap is suitable for use with any alignment key configuration.

- Maximum operating temperature: 135°C
- Watertightness: IP67 according to IEC 60529

- Lanyard material: Stainless steel
- Crimp ferrule material: Nickel-plated brass + polyolefin

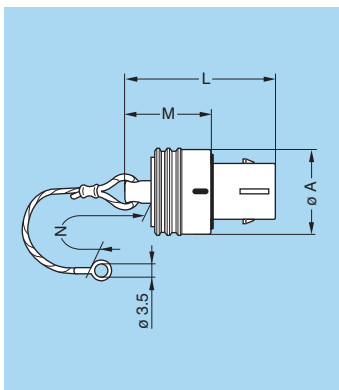
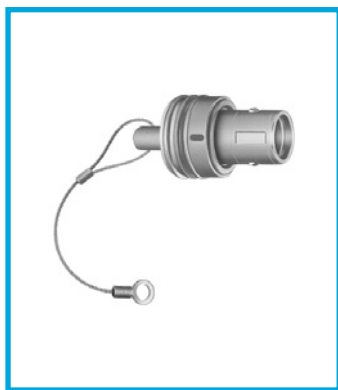

BRE Blanking caps, with latching for fixed sockets

Part number	Series	Dimensions (mm)			
		A	L	M	N
BRE.FF.200.YAV	FF	8.5	20.0	12.0	60
BRE.0F.200.XAV	0F	12.0	25.5	15.6	85
BRE.1F.200.XAV	1F	14.0	25.8	15.7	85
BRE.2F.200.XAV	2F	17.0	25.8	15.6	85
BRE.3F.200.XAV	3F	19.0	27.8	17.6	120
BRE.4F.200.XAV	4F	26.0	30.3	20.1	120
BRE.LF.200.XAV	LF	29.0	34.7	20.1	120

Note: this cap is suitable for use with any alignment key configuration. The BRE.0F cap has no keying and can be therefore used with any socket.

- Maximum operating temperature: 135°C
- Watertightness: IP67 according to IEC 60529

- Lanyard material: Stainless steel
- Crimp ferrule material: Nickel-plated brass + polyolefin

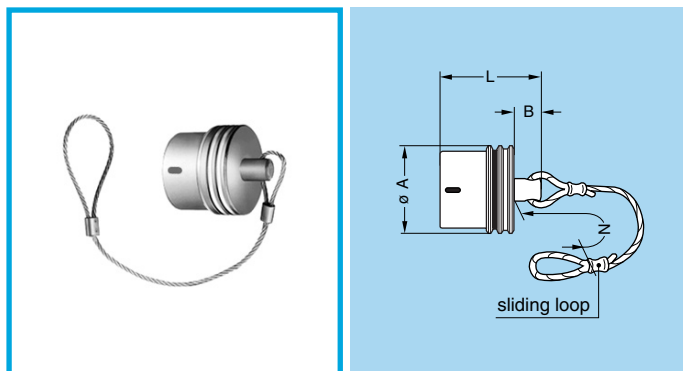

- Lanyard material: Stainless steel
- Crimp ferrule material: Nickel-plated brass + polyolefin

BFG Plug caps

Part number	Series	Dimensions (mm)			
		A	B	L	N
BFG.FF.100.XAZ	FF	8.5	4	14	60
BFG.0F.100.XAZ	0F	12.0	6	18	85
BFG.1F.100.XAZ	1F	14.0	6	18	85
BFG.2F.100.XAZ	2F	17.0	6	18	85
BFG.3F.100.XAZ	3F	19.0	8	20	120
BFG.4F.100.XAZ	4F	26.0	8	20	120
BFG.LF.100.XAZ	LF	30.0	8	24	120

Note: this cap is suitable for use with any alignment key configuration.

- Maximum operating temperature: 135°C
- Watertightness: IP67 according to IEC 60529

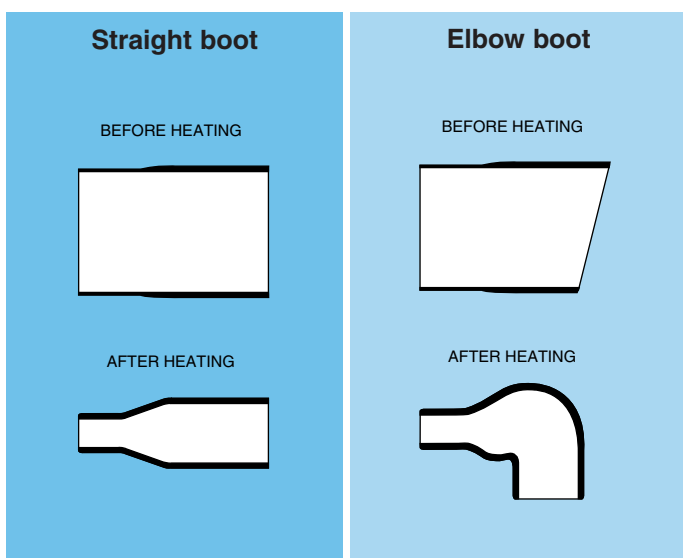

Heatshrink boot

Supplier	Series	Part number		Note	cable ø min. (mm)	
		Straight	Elbow 90°			
LEMO	FF	GMA.10.290.DN	GHA.10.210.DN	2)	2.2	
		202 A 111-25/86	222 A 111-25/86	1)	3.8	
	Raychem®	0F-1F-2F-3F	202 A 111-25	222 A 111-25	2)	3.8
			202 A 121-25/86	222 A 121-25/86	1)	5.3
		1F-2F-3F-4F	202 A 121-25	222 A 121-25	2)	5.3
			202 A 142-25/86	222 A 142-25/86	1)	7.4
Hellermann®	0F-1F-2F-3F	104-1-G	1108-1-G	2)	3.8	
		105-1-G	1106-1-G	2)	5.6	
	4F-5F	202 A 142-25	222 A 142-25	2)	7.4	
		101-1-G	1104-2-G	2)	7.1	

Note:

- 1) modified elastomer resistant to fluids with hot melt sealant.
- 2) elastomer resistant to fluids. We recommend a thermosetting sealant with this type of boot.

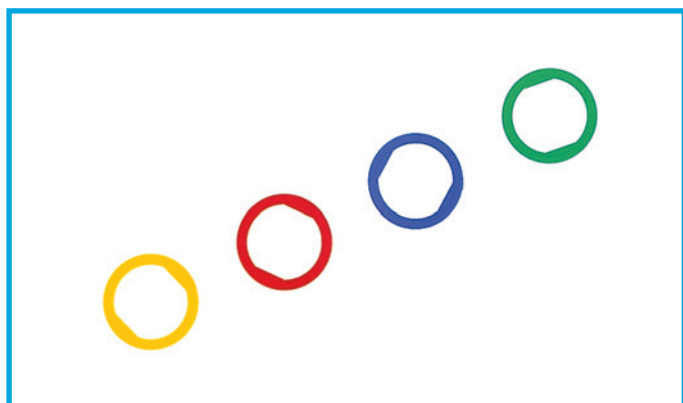

GRA Insulating washers

Part number	Series	Dimensions (mm)					
		A	B	E	L	M	T
GRA.0F.269.G●	0F	15	12.0	4	1.8	1.0	11
GRA.1F.269.G●	1F	19	15.0	4	2.0	1.1	14
GRA.2F.269.G●	2F	22	18.5	4	2.2	1.2	17
GRA.3F.269.G●	3F	24	20.5	4	2.2	1.2	19
GRA.4F.269.G●	4F	31	27.5	4	2.2	1.2	25
GRA.5F.269.G●	5F	40	36.5	4	2.2	1.2	34

For EG● sockets with a particular thread dimension, use B series insulating washers (see below).

Part number	Series	Dimensions (mm)					
		A	B	E	L	M	T
GRA.0S.269.G●	0F	12.0	10.8	6.0	1.8	1.0	9.9
GRA.1S.269.G●	1F	16.0	13.8	6.5	1.8	1.0	12.2
GRA.2S.269.G●	2F	21.1	17.9	7.3	2.3	1.3	16.2
GRA.3S.269.G●	3F	25.0	21.8	10.3	2.2	1.2	20.2

Note: the last position "●" of the part number indicates the colour. To obtain the required colour, refer to the above table and change position "●" of the part number to the corresponding letter.

Ref.	Colour	Keying
A	blue	N or W
J	yellow	P

Ref.	Colour	Keying
R	red	S or X
V	green	T

- Material: Polyamide

Tooling

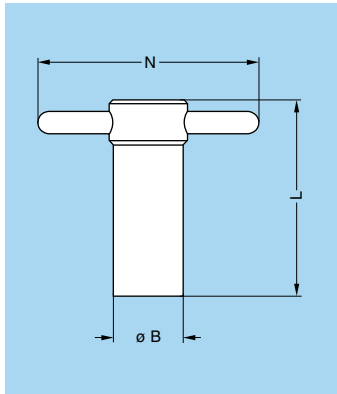

DCG Spanners for hexagonal nuts

Part number	Dimensions (mm)			Part number of the nut
	B	L	N	
DCG.91.149.0TN	14	40	50	GEA.00.240.LN
DCG.91.161.1TN	16	45	52	GEA.0S.240.LN
DCG.91.201.4TN	20	52	65	GEA.1S.240.LN
DCG.91.231.7TN	23	62	68	GEA.2S.240.LN
DCG.91.282.2TN	28	76	73	GEA.3S.240.LN

- Material: blackened steel

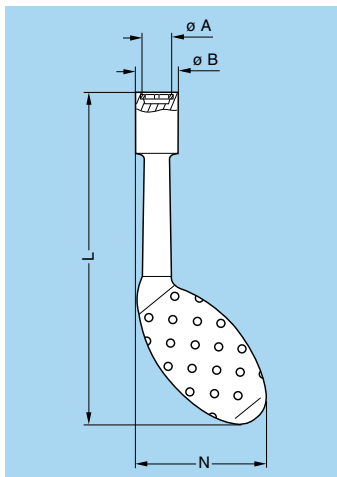

DCH Spanners for notched nut

Part number	Dimensions (mm)				Part number of the nut
	A	B	L	N	
DCH.91.101.PA	10.1	12.8	124	48.3	GEG.00.240.RN

- Material: Blue polyurethane

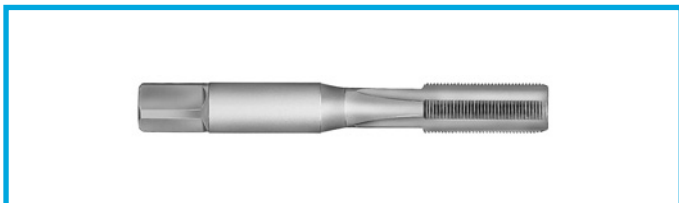

DTA Taps

Part number	Series	Thread
DTA.99.700.5Z	00	M7 x 0.5
DTA.99.900.6Z	0S-0B	M9 x 0.6



DPC Manual crimping tool

Part number
DPC.91.701.V

According to specification MIL-C-22520/7-01.
For LEMO contacts \varnothing 0.5-0.7-0.9-1.3 mm



Pneumatic crimping tools

Supplier	Part number
LEMO	DPC.91.701.C
BALMAR	85230
BUCHANAN	621101

According to specification MIL-C-22520/7-01.
For LEMO contacts \varnothing 0.5-0.7-0.9-1.3 mm

DCE Positioners for crimp contacts ø 0.5-0.7-0.9 and 1.3 mm

DCF Extractor for crimp contact ø 0.5-0.7-0.9 and 1.3 mm

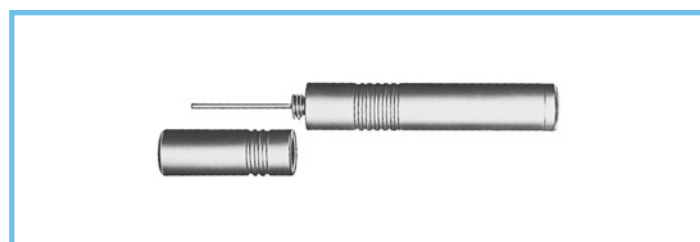
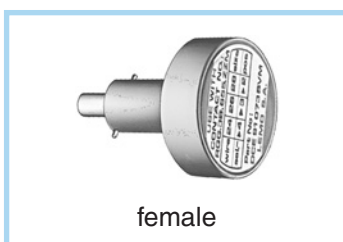
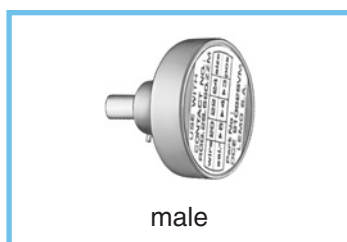

These positioners are suitable for use with both manual and pneumatic crimping tools according to the MIL-C-22520/7-01 standard.

	Connector + Contact					Positioners part number				Extractors part number
	Type	ø A	ø C	Fib.	Conductor AWG	For male contacts into plug	For female contacts into socket	For male contacts into socket	For female contacts into plug	
FF	303 304	0.5	0.42	1	28-30-32	DCE.91.050.0VC	DCE.91.050.0VM	DCE.91.050.0VC	DCE.91.050.0VM	DCF.91.050.2LT
OF	302 303	0.9	1.10	1	20-22-24	DCE.91.090.BVC	DCE.91.090.BVM	DCE.91.090.BVC	DCE.91.090.BVM	DCF.93.090.4LT
		0.9	0.80	2	22-24-26	DCE.91.090.AVC	DCE.91.090.AVM	DCE.91.090.AVC	DCE.91.090.AVM	DCF.93.090.4LT
	304 305	0.9	0.45	2	28-30-32	DCE.91.070.BVC	DCE.91.070.BVM	DCE.91.070.BVC	DCE.91.070.BVM	DCF.93.070.4LT
		0.7	0.80	1	22-24-26	DCE.91.070.BVC	DCE.91.070.BVM	DCE.91.070.BVC	DCE.91.070.BVM	DCF.93.070.4LT
1F	303	1.3	1.40	1	18-20	DCE.91.131.FVC	DCE.91.131.FVM	DCE.91.131.FVC	DCE.91.131.FVM	DCF.93.131.4LT
		0.9	1.10	1	20-22-24	DCE.91.090.BVC	DCE.91.090.BVM	DCE.91.090.BVC	DCE.91.090.BVM	DCF.93.090.4LT
	305	0.9	0.80	2	22-24-26	DCE.91.090.AVC	DCE.91.090.AVM	DCE.91.090.AVC	DCE.91.090.AVM	DCF.93.090.4LT
		0.9	0.45	2	28-30-32	DCE.91.070.BVC	DCE.91.070.BVM	DCE.91.070.BVC	DCE.91.070.BVM	DCF.93.070.4LT
	307/308	0.7	0.80	1	22-24-26	DCE.91.070.BVC	DCE.91.070.BVM	DCE.91.070.BVC	DCE.91.070.BVM	DCF.93.070.4LT
		0.7	0.45	2	28-30-32	DCE.91.070.BVC	DCE.91.070.BVM	DCE.91.070.BVC	DCE.91.070.BVM	DCF.93.070.4LT
2F	304	1.3	1.40	1	18-20	DCE.91.131.FVC	DCE.91.131.FVM	DCE.91.131.FVC	DCE.91.131.FVM	DCF.93.131.4LT
		0.9	1.10	1	20-22-24	DCE.91.090.BVC	DCE.91.090.BVM	DCE.91.090.BVC	DCE.91.090.BVM	DCF.93.090.4LT
	308 310	0.9	0.80	2	22-24-26	DCE.91.090.AVC	DCE.91.090.AVM	DCE.91.090.AVC	DCE.91.090.AVM	DCF.93.090.4LT
		0.9	0.45	2	28-30-32	DCE.91.070.BVC	DCE.91.070.BVM	DCE.91.070.BVC	DCE.91.070.BVM	DCF.93.070.4LT
	312 319	0.7	0.80	1	22-24-26	DCE.91.070.BVC	DCE.91.070.BVM	DCE.91.070.BVC	DCE.91.070.BVM	DCF.93.070.4LT
3F	322 330	0.7	0.80	1	22-24-26	DCE.91.070.BVC	DCE.91.070.BVM	DCE.91.070.BVC	DCE.91.071.FVM	DCF.93.070.4LT
		0.7	0.45	2	28-30-32	DCE.91.070.BVC	DCE.91.070.BVM	DCE.91.070.BVC	DCE.91.071.FVM	DCF.93.070.4LT
4F	340	0.7	0.80	1	22-24-26	DCE.91.072.BVC	DCE.91.070.BVM	DCE.91.070.BVC	DCE.91.072.BVM	DCF.93.070.4LT
		0.7	0.45	2	28-30-32	DCE.91.072.BVC	DCE.91.070.BVM	DCE.91.070.BVC	DCE.91.072.BVM	DCF.93.070.4LT
LF	368	0.7	0.80	1	22-24-26	DCE.91.073.BVC	DCE.91.072.BVM	DCE.91.070.BVC	DCE.91.073.BVM	DCF.93.070.4LT
		0.7	0.45	2	28-30-32	DCE.91.073.BVC	DCE.91.072.BVM	DCE.91.070.BVC	DCE.91.073.BVM	DCF.93.070.4LT
5F	350/354 355/364 366	0.9	1.10	1	20-22-24	DCE.91.093.BVC	DCE.91.093.BVM	DCE.91.093.BVC	DCE.91.093.BVM	DCF.91.093.5LT
		0.9	0.80	2	22-24-26	DCE.91.093.BVC	DCE.91.093.BVM	DCE.91.093.BVC	DCE.91.093.BVM	DCF.91.093.5LT

Note: see table on page 20 for connector selection and the table on page 24 for contact selection.

A wide variation of strand number and diameter combinations are quoted as being AWG, some of which do not have a large enough cross section to guarantee a crimp as per either MIL-C-22520/1-01 or /7-01. Our technical department is at your disposal to study and propose a solution to all your applications.

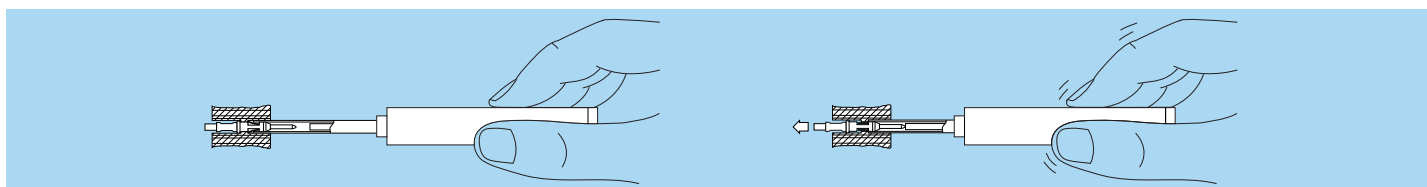
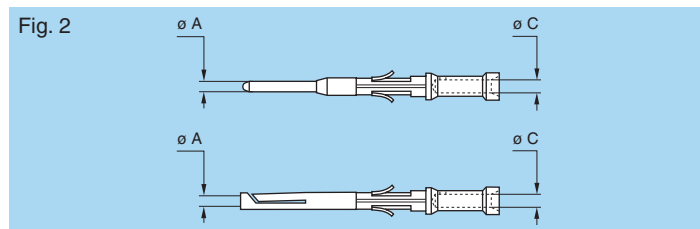
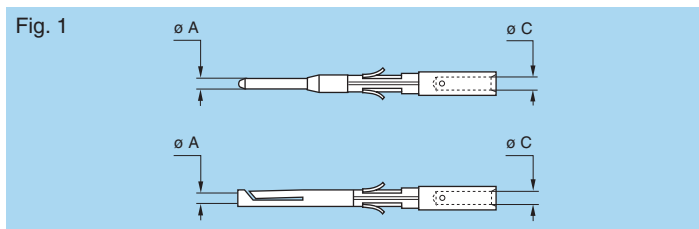



Banding tool

	Part number		
	GLEN-AIR®	TIE-DEX®	AXON®
Banding tool	600-061	A30199	ACDBS100
Tie wrap	600-057	A31189	AXCL0Z

Note: the banding tool is to be used with screened cables to ensure a good ground contact.

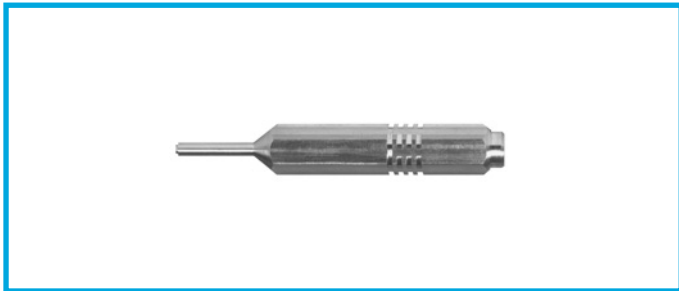

DCK Retention testing tools for crimp contacts 0.5-0.7-0.9 and 1.3 mm diameter

Contact ø A	Test force (N)	Testing tool part number	
		For male contact	For female contact
0.5	8	DCK.91.050.8LRC	DCK.91.050.8LRM
0.7	10	DCK.91.071.0LRC	DCK.91.071.0LRM
0.9	14	DCK.91.091.4LRC	DCK.91.091.4LRM
1.3	25	DCK.91.132.5LRC	DCK.91.132.5LRM



DRV Complete workstation for F7 fibre optic contact

Description

Comprehensive range of tools for terminating both single-mode and multi-mode fibres. Includes specific tools for F7 fibre optic contacts. Detachable termination case lid for use as polishing platform during field termination. Rugged but aesthetically pleasing termination case which is ideal for field use or in-house terminations. Curing oven and inspection microscope should be ordered separately.

Part number

DRV.91.CF7.PN

Note: See details in F7 catalogue.



DPE Crimping tool for F7 fibre optic contact

Description

Crimping tool for capturing KEVLAR® strand on contact body.

Part number

DPE.99.003.1K ¹⁾

Note: ¹⁾ Included in the LEMO F7 workstation.



WST Epoxy curing oven

Description

Oven for assisting in curing epoxy.

Part number	Voltage
WST.FR.220.VA	220 volts
WST.FR.110.VA	110 volts



DCS Polishing tool for fibre optic contacts

Description

Precision tool for polishing terminated fibre optic contacts with 1.25 mm ferrule.

Part number

DCS.91.D01.LC ¹⁾

Note: ¹⁾ Included in the LEMO F7 workstation.



WST Fibre Inspection Microscope

Description

Microscope to assist in viewing termination operations and verifying fibre end finish. Zoom with 200 → 400 x magnification. See adaptor on page 33.

Part number

WST.FB.G00.301



DCS Microscope adaptor for fibre optic contacts

Description

Adaptor for final inspection of fibre optic contacts with 1.25 mm ferrule.

To be used with microscope WST.FB.G00.301.

Part number

DCS.91.G90.6E125¹⁾

Note: ¹⁾ Included in the LEMO F7 workstation.



DCS F7 contact alignment device tool

Description

Simple tool with two threaded end for installation/extraction of the F7 contact alignment device.

Part number

DCS.F7.035.PN¹⁾

Note: ¹⁾ Included in the LEMO F7 workstation.

Panel Cut-out

Panel cut-outs

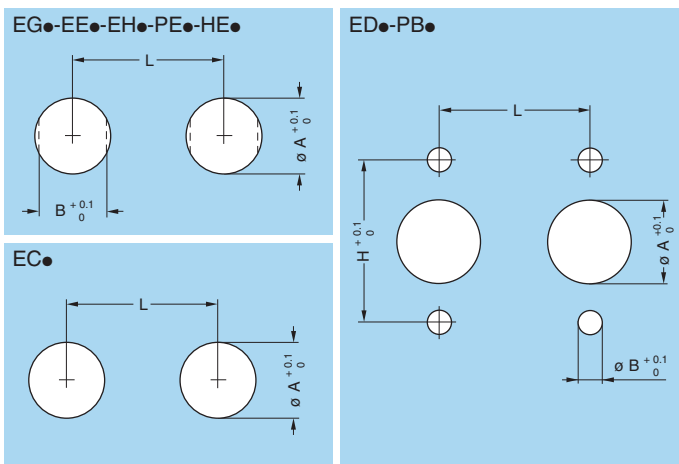

Mounting nut torque

Series	Torque (Nm)
FF	0.25
0F	1.00
1F	1.50
2F	2.00

Series	Torque (Nm)
3F	2.50
4F	5.00
LF	6.00
5F	8.00

Models		Series	Dimensions (mm)					
			A	B	L	H		
EC●		FF	7.1	–	11.5	–		
–	EH●	HE●	PE●	FF	7.1	6.5	11.5	–
EE●	EH●	HE●	PE●	0F	10.1	9.1	16.0	–
EE●	EH●	HE●	PE●	1F	13.1	11.6	20.0	–
EE●	EH●	HE●	PE●	2F	16.1	14.6	23.0	–
EE●	EH●	HE●	PE●	3F	18.2	16.6	25.0	–
–	EH●	HE●	PE●	4F	24.2	22.2	32.0	–
–	EH●	HE●	PE●	LF	27.2	25.1	35.0	–
–	EH●	HE●	PE●	5F	33.2	31.2	41.0	–
EG●		0F	9.1	8.3	13.5	–		
EG●		1F	12.1	10.6	17.0	–		
EG●		2F	15.1	13.6	21.5	–		
EG●		3F	18.1	16.6	27.0	–		
ED●		1F	6.2	3.5	15.0	19.3		
PB●		0F	11.1	3.2	16.0	21.4		
PB●		1F	13.1	3.2	16.0	21.4		
PB●		2F	16.1	3.2	19.0	25.9		
PB●		3F	17.6	3.2	21.0	29.0		
PB●		4F	23.2	3.2	27.0	32.0		
PB●		5F	32.3	3.2	34.0	38.2		

PCB drilling pattern

Fixed socket with straight print contact

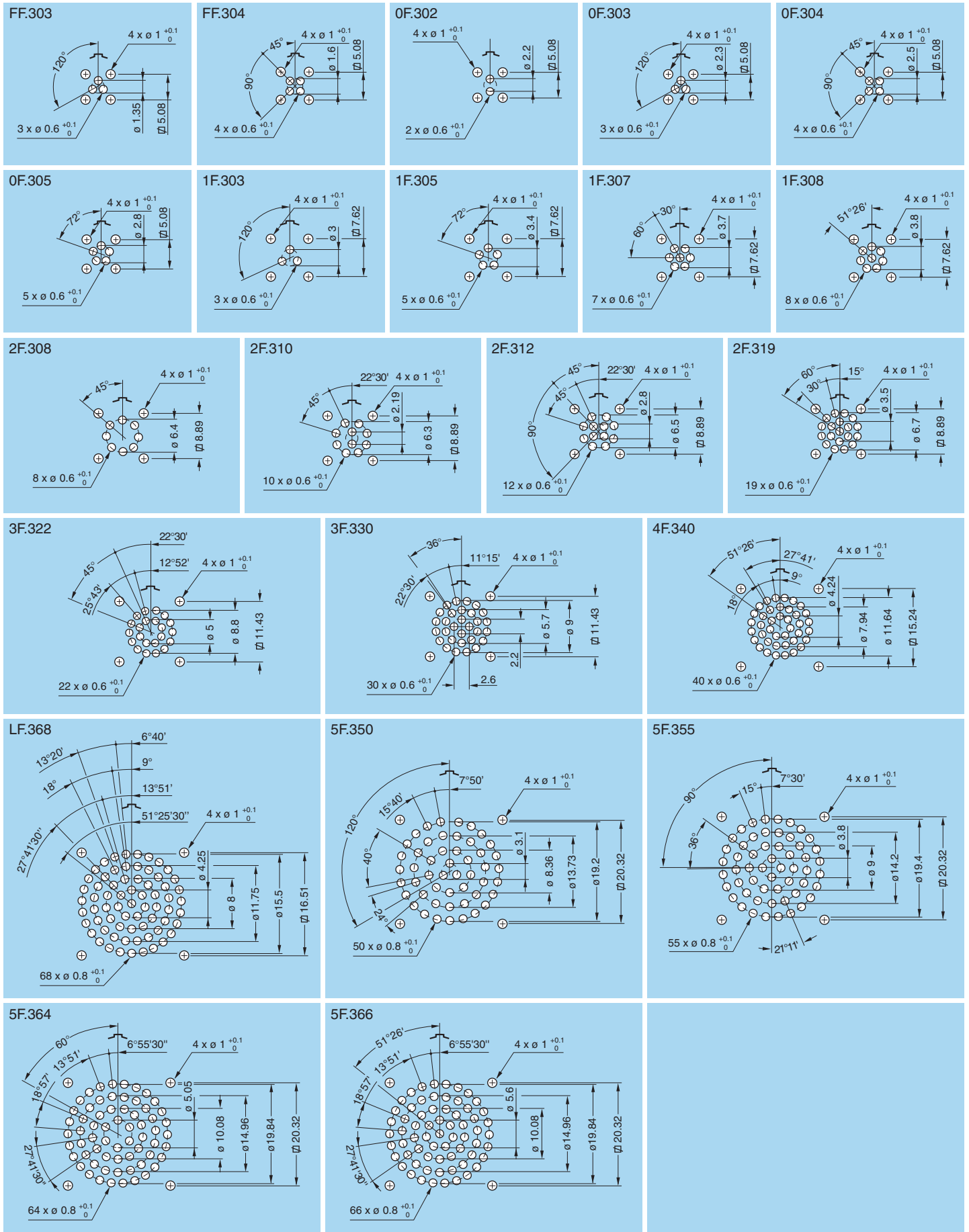

Fixed socket with elbow print contact

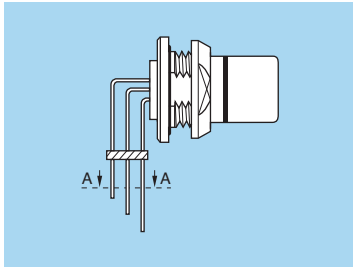

0F.302

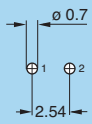

0F.303

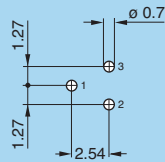

0F.304

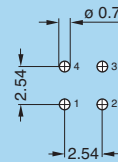

0F.305

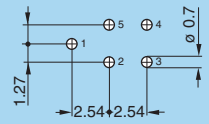

1F.303

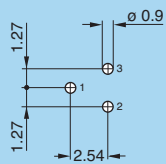

1F.305

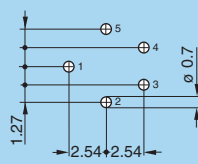

1F.307

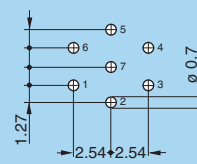

1F.308

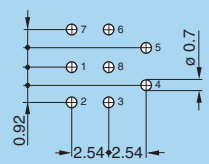

2F.308

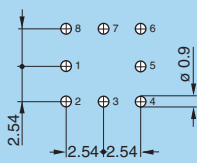

2F.310

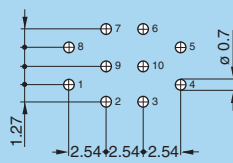

2F.312

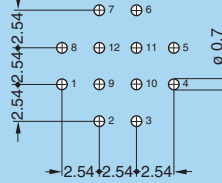

2F.319

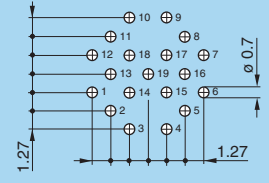

Technical characteristics

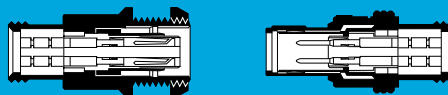

Outer shell

Mechanical latching characteristics

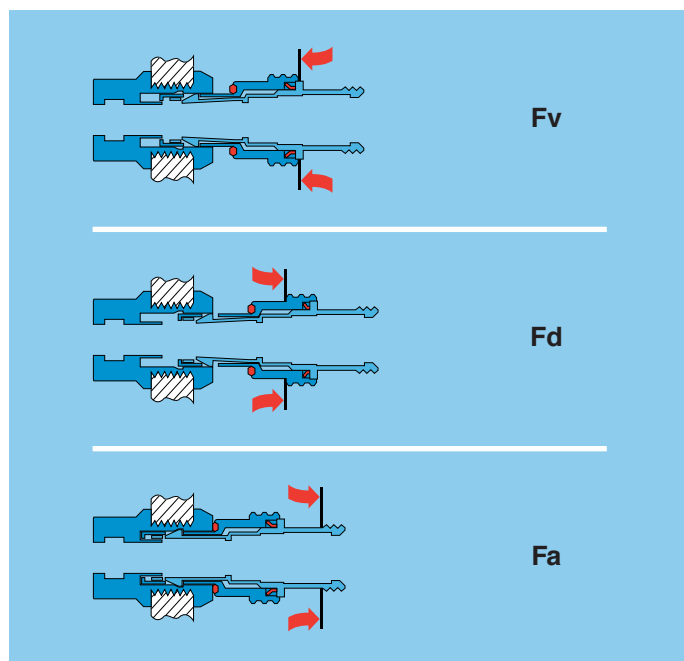

Latch sleeve in special bronze/brass

Force (N)	Series					
	0F	1F	2F	3F	4F	5F
Fv	10	11	20	18	23	40
Fd	11	13	29	20	25	40
Fa	160	120	170	210	180	250

Latch sleeve in Beryllium copper

Force (N)	Series				
	FF	0F	1F	2F	3F
Fv	16	22	21	29	34
Fd	20	21	23	33	17
Fa	110	300	250	420	400

Notes: forces were measured on outer shells **not fitted with contacts**.

1N = 0.102 kg.

1N = 0.2248 pounds force

F_v: average latching force.

F_d: average unmating force with axial pull on the outer shell.

F_a: average pull-out force with axial pull on the back shell.

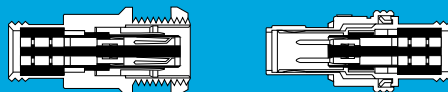

Insulator

Plastic material used by LEMO for manufacturing insulators is selected according to the electric and thermal properties required for the various connector types. Characteristics examined for the two connector types are:

- Dielectric strength
- Comparative tracking index
- Surface and volume resistivity
- Continuous service temperature
- Water absorption
- Radiation resistance
- Flammability rating
- Resistance to hydrocarbon.

Mechanical and electrical properties

Mechanical characteristics of thermoplastics, such as PEEK, are improved by the addition of glass fibres. By adding glass fibres in the resin the performance of this material (mechanical strength and radiation resistance) is enhanced and water absorption rate is reduced. From an electric point of view, the addition of glass fibres improves dielectric strength.

PEEK is selected as it provides all the required characteristics for multipole connectors.

Radiation resistance

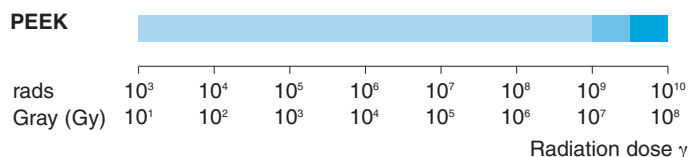

- Damage**
- Minimum to slight (almost available usable)
 - Slight to medium (often satisfactory)
 - Medium to serious (not usable)

Note: technical data in this chapter provide general information on plastics used by LEMO as electrical insulators. LEMO reserves the right to propose new materials with better technical characteristics, and to withdraw, without notice, any material mentioned in the present catalogue or any other publications edited by LEMO S.A. and/or its subsidiaries. LEMO SA and its subsidiaries use only plastic granules, powder or bars supplied by specialized companies, and thus cannot in any case take responsibility with regard to this material.

Technical characteristics of plastic materials

Type	Norme	Units	PEEK	Silicone	FPM/FKM	Epoxy
Density	ASTM D 792	–	1.3-1.4	~1.2	~1.9	1.58
Tensile strength (at 23°C)	ASTM D 638/ ISO R527	MPa	92-142	> 9	> 12	16
Flexural strength (at 23°C)	ASTM D 790/ ISO R178	MPa	170	–	–	24
Dielectric strength	ASTM D 149/IEC 60243	kV/mm	19-25	18-30	–	15
Volume resistivity at 50% HR and 23°C	ASTM D 257/IEC 60093	$\Omega \bullet \text{cm}$	10^{16}	10^{14}	–	10^{14}
Surface resistivity	ASTM D 257	Ω	10^{15}	–	–	–
Thermal conductivity	ASTM C 177	W/K \bullet m	0.25	–	–	0.8
Comparative tracking index	IEC 60112	V	CTI 150	–	–	CTI>600
Dielectric constant (10 ⁶ Hz)	ASTM D 150/IEC 60250	–	3.2-3.5	–	–	–
Dissipation factor (10 ⁶ Hz)	ASTM D 150/IEC 60250	–	< 0.005	–	–	–
Maximum continuous service temperature	UL 746	°C	250	200	200	80
Minimum continuous service temperature	UL 746	°C	-50	-50	-20	-20
Maximum short-time service temperature	–	°C	300	> 250	300	120
Water absorption in 24h at 23°C	ASTM D 570/ISO R62A	%	< 0.3	–	–	0.25
Radiation resistance	–	Gy ¹⁾	10^7	10^5	8×10^4	2×10^6
Flammability rating	ASTM D 635/UL 94	–	V-0/3.2	–	–	V-0/4

Notes: 1) 1 Gy (Gray) = 100 rad

ASTM = American Society for Testing Material
 ISO = International Standards Organisation
 UL = Underwriters Laboratories
 IEC = International Electrotechnical Commission

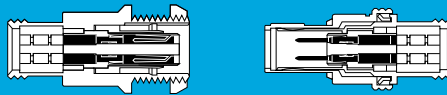

Electrical contact

Technical description

The secure reliable electromechanical connection achieved with LEMO female cylindrical contacts is mainly due to two important design features:

1. *Prod proof entry* on the mating side which ensures perfect concentric mating even with carelessly handled connectors.
2. *The pressure spring*, with good elasticity, maintains a constant even force on the male contact when mated. The leading edge of the pressure spring preserves the surface treatment (gold-plated) and prevents undue wear.

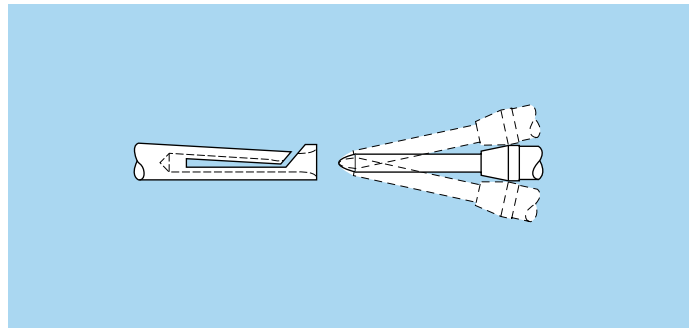

Contact material and treatment

LEMO female contacts are made of bronze beryllium (QQ-C-530) or bronze (UNS C 54400). These materials are chosen because of their high modulus of elasticity, their excellent electrical conductivity and a high mechanical strength. LEMO male print contacts are made of brass (UNS C 38500). Male crimp contacts are made of brass (UNS C 34500) or annealed brass (UNS C 38500) with optimum hardness (HV) for crimping onto the wire.

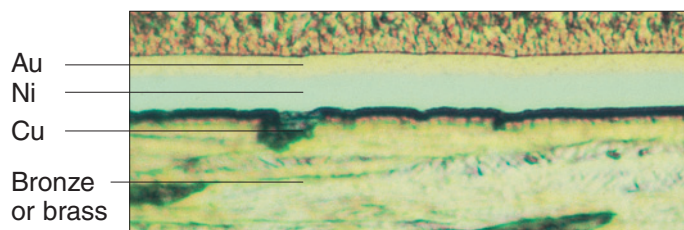

Type	Material (standard)	Surf. treatment (μm)		
		Cu	Ni	Au ¹⁾
Male crimp	Brass (UNS C 34500)	0.5	3	1.0
Male print	Brass (UNS C 38500)			
Female crimp	Bronze (UNS C 54400)	0.5	3	1.5
Female print	Cu-Be (FS QQ-C-530)			
Clips	Cu-Be (FS QQ-C-530)	–	–	–
	Stainless steel			
Wire ²⁾	Brass	–	3 ³⁾	–

Notes: the standard surface treatment are as follows:

– nickel: SAE AMS QQ N 290 or MIL DTL 32119
 – gold: ISO 27874.

1) minimum value

2) for elbow print contacts

3) treatment completed by 6 μm Sn-Pb tin-plating

Thickness comparison between the outside and the inside of female contacts

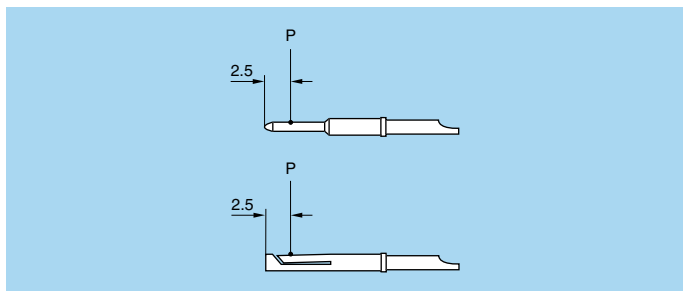

Contact ø A (mm)	Gold thickness		
	male (µm)	female	
		outside (µm)	inside (%)
0.5	1.0	1.5	65
0.7	1.0	1.5	70
0.9	1.0	1.5	75
1.3	1.0	1.5	75

Note: P = inspection point

Crimp contacts

The square form crimp method is used (MIL-C-22520F, class I, type 2) photo 1 for unipole contacts.

For multipole contacts the standard four identer crimp method is used, (MIL-C-22520F, class I, type 1), photo 2. The crimp method requires a controlled compression to obtain a symmetrical deformation of the conductor strand and of the contact material. The radial hole in the side of the contact makes it possible to check whether the conductor is correctly positioned within the contact. A good crimping is characterized by only slightly reduced conductor section and practically no gap.

For optimum crimping of bronze or brass contacts they are annealed to relieve internal stress and reduce material hardening during the crimping process.

Only the crimping zone is annealed with the help of an induction heating machine designed by the LEMO Research and Development Department (see photo 3).

Advantages of crimping

- practical, quick contact fixing outside the insulator
- possible use at high temperature
- no risk of heating the insulator during the conductor-contact fixing
- high tensile strength

Crimp contacts are available in standard version (form 1) for mounting maximum size conductors.

For some dimensions, these crimp contacts can be produced with reduced crimp barrels (form 2) for mounting reduced size conductors.

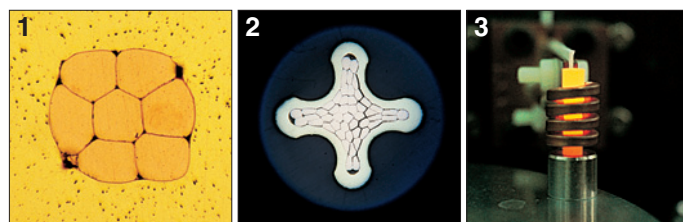

Test voltage

Test voltage (U_e):
(measured according to the IEC 60512-2 test 4a standard)

It corresponds to 75% of the mean breakdown voltage.
Test voltage is applied at 500 V/s and the test duration is 1 minute.

This test has been carried out with a mated plug and socket, with power supply only on the plug end.

Operating voltage (U_s):
It is proposed according to the following ratio: $U_s = \frac{U_e}{3}$

Caution:

For a number of applications, safety requirements for electrical appliances are more severe with regard to operating voltage.

In such cases operating voltage is defined according to creepage distance and air clearance) between live parts.

Please consult us for the choice of a connector by indicating the safety standard to be met by the product.

Voltage values are given in the table on insulator types for each series.

They correspond with values measured at sea level. They are adapted to all applications up to an altitude of 2000 m.

In case a device is used at a higher altitude, air clearance between live parts has to be multiplied by the following coefficients.

It means also that test voltage has to be divided by this coefficient.

altitude (m)	coefficient
2000	1.00
3000	1.14
4000	1.29
5000	1.48

Rated current

(measured according to IEC 60512-3 test 5a)

The specified rated current can be applied simultaneously to all the contacts. It corresponds with an average temperature rise of 40°C of the connector.

The current values are indicated in the table of insulator types in each series.

For use at higher temperatures acceptable rated current will be lower. It tends towards zero as the material is used at the maximum operating temperature accepted for the insulator.

In most case the current depend on the conductor dimension (see table on page 43) or on the printed circuit dimension.

Caution: In general, connectors should not be unmated while live.

For connectors with PEEK insulator, maximum admissible current will follow the curve below depending on the operating temperature T.

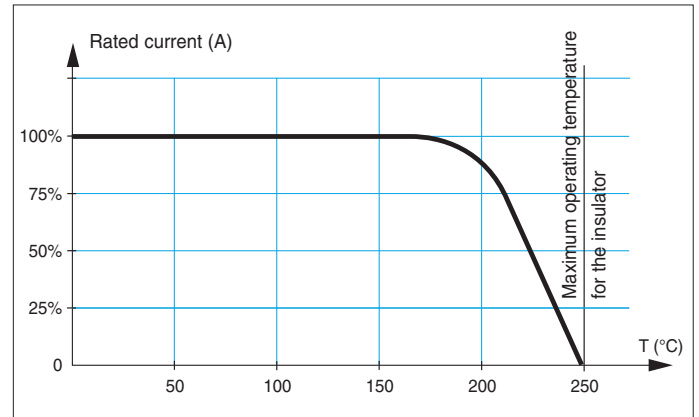

Assembly instructions

Assembly instructions for plugs and sockets

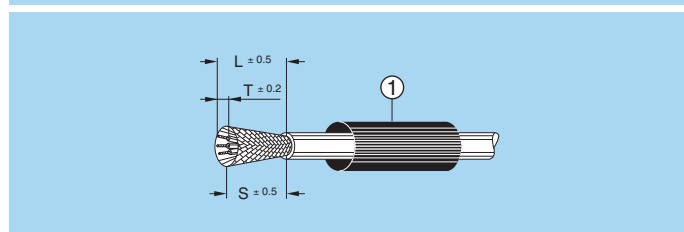
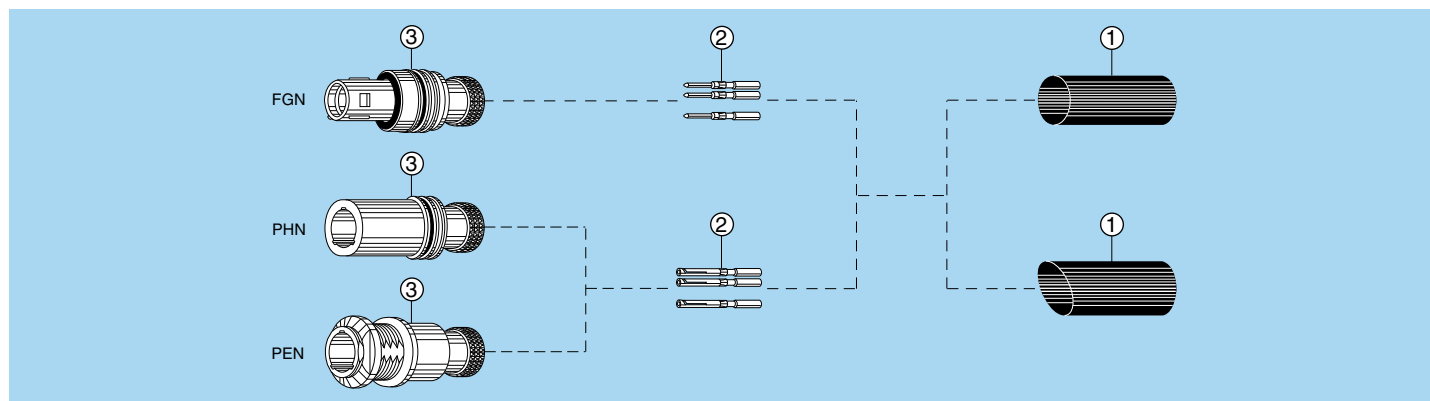

1. Cable preparation

First place the heatshrink boot ① over the cable. Strip the cable according to dimensions of the table, then widen the shield.

Series	L	S	T
FF	14	9	3
OF-5F	20	15	4

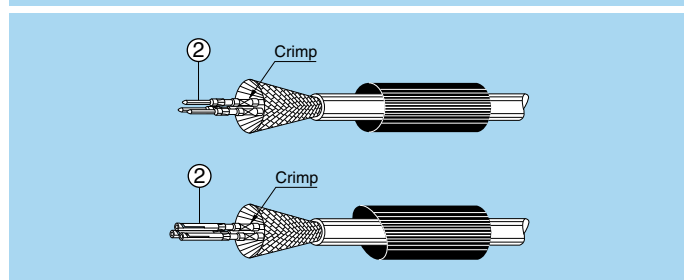

2. Cable termination

2.1 With shielded cables, widen and pull the shield all the way to the back. Fix the appropriate positioner onto the crimping tool and set the selector to the number corresponding to the AWG of the conductor used as indicated on the positioner label. Fit the conductor into the contact ②; make sure it is visible through the contact's inspection hole. Slide the conductor-contact assembly into the open crimping tool; make sure that the contact is pushed fully into the positioner. Close the tool. Remove from crimping tool and check that conductor is secure in contact and shows in inspection hole.

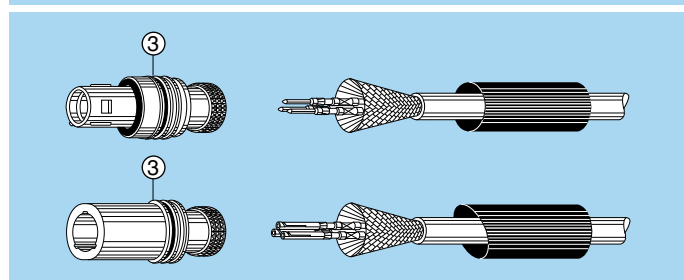

2.2 Arrange the conductor-contact assemblies according to the markings, into the rear cable seal. Push them deeply into the insulator, using tweezers if necessary; check that all the contacts are correctly located in the insulator: 1) by verifying the alignment of the contacts at the front of the insulator and 2) by gently pulling on each conductor. Verification should also be made using the appropriate retention testing tool. With FF series the rear cable seal can be replaced with a silicone RTV compound that is filled on the rear of the connector once the contacts are correctly installed.

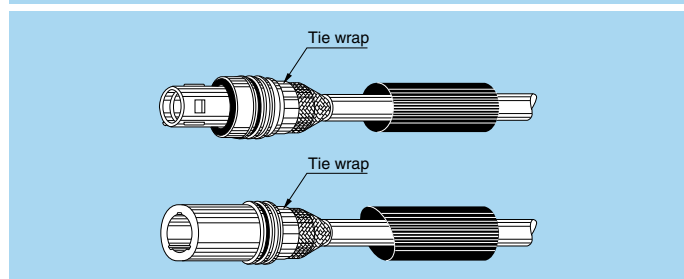

2.3 Bring the shield around the rear of connector. Secure it with a band-it tie-wrap (not furnished) to fix the shield in place. Cut off the possible shield surplus.

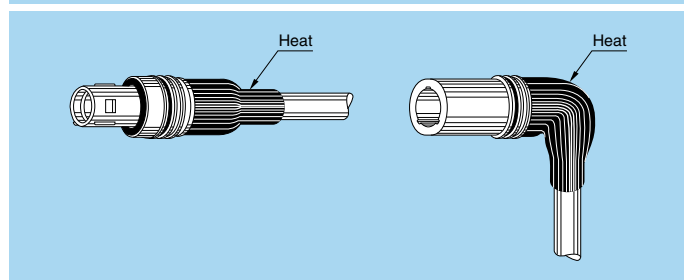

2.4 Put the heatshrink boot in place and heat gently until it retracts.

Technical tables

Table of American Wire Gauge

AWG	Construction		ø wire max		Wire section	
	Strand nb	AWG/strand	(mm)	(in)	(mm ²)	(sq in)
4	133	25	6.9596	0.274	21.5925	0.0335
6	133	27	5.5118	0.217	13.5885	0.0211
8	168	30	4.4450	0.175	8.5127	0.0132
8	133	29	4.3942	0.173	8.6053	0.0133
10	105	30	3.3020	0.13	5.3204	0.0082
10	37	26	2.9210	0.115	4.7397	0.0073
10	1	10	2.6162	0.103	5.2614	0.0082
12	65	30	2.5146	0.099	3.2936	0.0051
12	37	28	2.3114	0.091	2.9765	0.0046
12	19	25	2.3622	0.093	3.0847	0.0048
12 ¹⁾	7	20	2.5400	0.1	3.6321	0.0056
12	1	12	2.0828	0.082	3.3081	0.0051
14	41	30	2.0574	0.081	2.0775	0.0032
14	19	27	1.8542	0.073	1.9413	0.0030
14 ¹⁾	7	22	2.0828	0.082	2.2704	0.0035
14	1	14	1.6510	0.065	2.0820	0.0032
16 ¹⁾	65	34	1.5748	0.062	1.3072	0.0020
16	26	30	1.5748	0.062	1.3174	0.0020
16	19	29	1.4986	0.059	1.2293	0.0019
16 ¹⁾	7	24	1.5494	0.061	1.4330	0.0022
16	1	16	1.3208	0.052	1.3076	0.0020
18 ¹⁾	65	36	1.2700	0.05	0.8234	0.0013
18 ¹⁾	42	34	1.2700	0.05	0.8447	0.0013
18	19	30	1.3208	0.052	0.9627	0.0015
18	16	30	1.2954	0.051	0.8107	0.0013
18	7	26	1.2700	0.05	0.8967	0.0014
18	1	18	1.0414	0.041	0.8229	0.0013
20 ¹⁾	42	36	1.0160	0.04	0.5320	8.2x10 ⁻⁴
20	19	32	1.0414	0.041	0.6162	0.0010
20	10	30	1.0160	0.04	0.5067	7.9x10 ⁻⁴
20	7	28	0.9906	0.039	0.5631	8.7x10 ⁻⁴
20	1	20	0.8382	0.033	0.5189	8.0x10 ⁻⁴
22	19	34	0.8382	0.033	0.3821	5.9x10 ⁻⁴
22	7	30	0.7874	0.031	0.3547	5.5x10 ⁻⁴
22	1	22	0.6604	0.026	0.3243	5.0x10 ⁻⁴
24 ¹⁾	42	40	0.6604	0.026	0.2045	3.2x10 ⁻⁴
24	19	36	0.6858	0.027	0.2407	3.7x10 ⁻⁴
24	7	32	0.6350	0.025	0.2270	3.5x10 ⁻⁴
24	1	24	0.5588	0.022	0.2047	3.2x10 ⁻⁴
26	19	38	0.5588	0.022	0.1540	2.4x10 ⁻⁴
26	7	34	0.5080	0.02	0.1408	2.2x10 ⁻⁴
26	1	26	0.4318	0.017	0.1281	2.0x10 ⁻⁴
28 ¹⁾	19	40	0.4318	0.017	0.0925	1.4x10 ⁻⁴
28	7	36	0.4064	0.016	0.0887	1.4x10 ⁻⁴
28	1	28	0.3302	0.013	0.0804	1.2x10 ⁻⁴
30	7	38	0.3302	0.013	0.0568	8.8x10 ⁻⁵
30	1	30	0.2794	0.011	0.0507	7.9x10 ⁻⁵
32	7	40	0.2794	0.011	0.0341	5.3x10 ⁻⁵
32	1	32	0.2286	0.009	0.0324	5.0x10 ⁻⁵
34	1	34	0.1693	0.007	0.0201	3.1x10 ⁻⁵
36	1	36	0.127	0.005	0.0127	2.0x10 ⁻⁵
38	1	38	0.1016	0.004	0.0081	1.3x10 ⁻⁵
40	1	40	0.078	0.003	0.0049	7.5x10 ⁻⁶

Note: ¹⁾ not included in the standard

Table of wire gauges according to IEC-228 standard

Conductor no x Ø (mm)	Max Ø (mm)	Max Ø (in)	Section (mm ²)	Section (sq in)
196x0.40	7.50	0.295	25.00	0.0387
7x2.14	6.10	0.240	25.00	0.0387
125x0.40	6.00	0.236	16.00	0.0248
7x1.72	4.90	0.192	16.00	0.0248
1x4.50	4.50	0.177	16.00	0.0248
80x0.40	4.70	0.155	10.00	0.0155
7x1.38	3.95	0.155	10.00	0.0155
1x3.60	3.60	0.141	10.00	0.0155
84x0.30	3.70	0.145	6.00	0.0093
7x1.50	3.15	0.124	6.00	0.0093
1x2.76	2.76	0.108	6.00	0.0093
56x0.30	2.80	0.110	4.00	0.0062
7x0.86	2.58	0.098	4.00	0.0062
1x2.25	2.25	0.082	4.00	0.0062
50x0.25	2.15	0.084	2.50	0.0038
7x0.68	2.04	0.080	2.50	0.0038
1x1.78	1.78	0.070	2.50	0.0038
30x0.25	1.60	0.062	1.50	0.0023
7x0.52	1.56	0.061	1.50	0.0023
1x1.4	1.40	0.055	1.50	0.0023
32x0.20	1.35	0.053	1.00	0.0015
7x0.43	1.29	0.050	1.00	0.0015
1x1.15	1.15	0.045	1.00	0.0015
42x0.15	1.20	0.047	0.75	0.0011
28x0.20	1.15	0.045	0.75	0.0011
1x1.0	1.00	0.039	0.75	0.0011
28x0.15	0.95	0.037	0.50	7.7x10 ⁻⁴
16x0.20	0.90	0.035	0.50	7.7x10 ⁻⁴
1x0.80	0.80	0.031	0.50	7.7x10 ⁻⁴
7x0.25	0.75	0.029	0.34	5.2x10 ⁻⁴
1x0.60	0.60	0.023	0.28	4.3x10 ⁻⁴
14x0.15	0.75	0.029	0.25	3.8x10 ⁻⁴
7x0.20	0.65	0.023	0.22	3.4x10 ⁻⁴
18x0.10	0.50	0.019	0.14	2.1x10 ⁻⁴
14x0.10	0.40	0.015	0.11	1.7x10 ⁻⁴
21x0.07	0.40	0.015	0.09	1.3x10 ⁻⁴
14x0.10	0.40	0.015	0.09	1.3x10 ⁻⁴

Maximum current rating for conductor

Maximum current on insulated conductors up to an ambient temperature of 30° C (from VDE 0100, parts 430 and 532 as well as other VDE regulations).

Nominal section mm ²	Group 2 Intens. max. A	Group 3 Intens. max. A
0.08	1.0	1.5
0.14	2.0	3.0
0.25	4.0	5.0
0.34	6.0	8.0
0.50	9.0	12.0
0.75	12.0	15.0
1.00	15.0	19.0
1.50	18.0	24.0
2.50	26.0	32.0

Group 2 Multi-conductor, e. g. solid cable under sheath, shielded cable, lead-sheath cables, ...
 Group 3 Single conductor and single conductor cable laid on open air in a way to leave at least a space between them equal to their diameter

Conversion of some units:

millimeters into inches:	1 mm = 0.0394 in
inches into millimeters:	1 in = 25.4 mm
centimeters into feet:	1 cm = 0.0328 ft
feet (12 in) into centimeters:	1 ft = 30.48 cm
square centimeters into square inches:	1 cm ² = 0.155 sq in
square inches into square centimeters:	1 sq in = 6.4516 cm ²
bar into pounds per square inch:	1 bar = 14.51 psi
bar into Pascal:	1 bar = 10 ⁵ Pa
°C into °F:	°F = °C•1.8 + 32
newtonmeter (Nm) into inch pound (in•lb)	1 Nm = 8.85 in•lb
mbar•l•s ⁻¹ into Torr•l•s ⁻¹	1 mbar•l•s ⁻¹ = 1.33 Torr•l•s ⁻¹

Product safety notice

PLEASE READ AND FOLLOW ALL INSTRUCTIONS CAREFULLY AND CONSULT ALL RELEVANT NATIONAL AND INTERNATIONAL SAFETY REGULATIONS FOR YOUR APPLICATION. IMPROPER HANDLING, CABLE ASSEMBLY, OR WRONG USE OF CONNECTORS CAN RESULT IN HAZARDOUS SITUATIONS.

1. SHOCK AND FIRE HAZARD

Incorrect wiring, the use of damaged components, presence of foreign objects (such as metal debris), and / or residue (such as cleaning fluids), can result in short circuits, overheating, and / or risk of electric shock.

Mated components should never be disconnected while live as this may result in an exposed electric arc and local overheating, resulting in possible damage to components.

2. HANDLING

Connectors and their components should be visually inspected for damage prior to installation and assembly. Suspect components should be rejected or returned to the factory for verification.

Connector assembly and installation should only be carried out by properly trained personnel. Proper tools must be used during installation and / or assembly in order to obtain safe and reliable performance.

3. USE

Connectors with exposed contacts should never be live (or on the current supply side of a circuit). Under general conditions voltages above 30 VAC and 42 VDC are considered hazardous and proper measures should be taken to eliminate all risk of transmission of such voltages to any exposed metal part of the connector.

4. TEST AND OPERATING VOLTAGES

The maximum admissible operating voltage depends upon the national or international standards in force for the application in question. Air and creepage distances impact the operating voltage; reference values are indicated in the catalog however these may be influenced by PC board design and / or wiring harnesses.

The test voltage indicated in the catalog is 75% of the mean breakdown voltage; the test is applied at 500 V/s and the test duration is 1 minute.

5. CE MARKING

CE marking  means that the appliance or equipment bearing it complies with the protection requirements of one or several European safety directives.

CE marking  applies to complete products or equipment, **but not to electromechanical components, such as connectors.**

6. PRODUCT IMPROVEMENTS

The LEMO Group reserves the right to modify and improve to our products or specifications without providing prior notification.

LEMO complete product range

	B	S	K	E	F	00	01	0A	3T	4A	4M	3K.93C	1D	Y	05	5G	2G	2C	L	H	M	R	N	03	V	W	T7	P	D	K/S	01	DIN	
Unipole																																	
Multipole					•																												
Coaxial 50 Ω																																	
Coaxial 75 Ω																																	
Multi Coaxial																																	
Mixed Coax + LV																																	
Triaxial 50 Ω																																	
Triaxial 75 Ω																																	
Mixed Triax + LV																																	
Quadrax																																	
High Voltage																																	
Multi High Voltage																																	
Mixed HV + LV																																	
Fibre Optic																																	
Multi Fibre Optic					•																												
Mixed FO + LV					•																												
Thermocouple																																	
Fluidic																																	
Multi Fluidic																																	
Mixed Fluidic + LV																																	

Most frequently used in darker colour

• included in this catalogue

B Series <small>Keyed</small>	S Series	K Series <small>Keyed</small>	E Series	F Series <small>Keyed</small>	00 Series	01 Series
0A Series	3T Series	4A Series	4M Series <small>Keyed</small>	3K.93C Series <small>Keyed</small>	1D Series	Y Series
05 Series	5G Series <small>Keyed</small>	2G Series <small>Keyed</small>	2C Series	L Series <small>Keyed</small>	H Series	M Series <small>Keyed</small>
R Series <small>Keyed</small>	N Series <small>Keyed</small>	03 Series <small>Keyed</small>	V Series	W Series <small>Keyed</small>	Cable assembly	K/S Series <small>Keyed</small>
REDEL T7 Series	REDEL P Series <small>Keyed</small>	REDEL D Series	01 Series <small>Keyed</small>	VAA Series	SAA Series	TAA Series

No reproduction or use without express permission of editorial or pictorial content, in any manner.
LEMO SA reserves the right to modify and improve specifications, at all times, without any notification.

LEMO HEADQUARTERS

SWITZERLAND

LEMO SA

Chemin des Champs-Courbes 28 - P.O. Box 194 - CH-1024 Ecublens
Tel. (+41 21) 695 16 00 - Fax (+41 21) 695 16 02 - e-mail: info@lemo.com

LEMO SUBSIDIARIES

AUSTRIA

LEMO Elektronik GesmbH

Lemböckgasse 49/E6-3
1230 Wien
Tel: (+43 1) 914 23 20 0
Fax: (+43 1) 914 23 20 11
sales@lemo.at

BRAZIL

LEMO Latin America Ltda

Av. José Rocha Bonfim,
214 Salas 224 / 225
Condomínio Praça Capital
Ed. Chicago
Campinas / SP - Brasil 13080-650
Tel: +55 (11) 98689 4736
rodrigues@lemo.com

CANADA

LEMO Canada Inc

44 East Beaver Creek Road, unit 20
Richmond Hill, Ontario L4B 1G8
Tel: (+1 905) 889 56 78
Fax: (+1 905) 889 49 70
info-canada@lemo.com

CHINA / HONG KONG

LEMO Electronics (Shanghai) Co., Ltd

First Floor, Block E,
18 Jindian Road, Pudong
Shanghai, China, 201206
Tel: (+86 21) 5899 7721
Fax: (+86 21) 5899 7727
cn.sales@lemo.com

DENMARK

LEMO Denmark A/S

Gammel Mosevej 46
2820 Gentofte
Tel: (+45) 45 20 44 00
Fax: (+45) 45 20 44 01
info-dk@lemo.com

FRANCE

LEMO France Sàrl

24/28 Avenue Graham Bell
Bâtiment Balthus 4
Bussy Saint Georges
77607 Marne la Vallée Cedex 3
Tel: (+33 1) 60 94 60 94
Fax: (+33 1) 60 94 60 90
info-fr@lemo.com

GERMANY

LEMO Elektronik GmbH

Hanns-Schwindt-Str. 6
81829 München
Tel: (+49 89) 42 77 03
Fax: (+49 89) 420 21 92
info@lemo.de

HUNGARY

REDEL Elektronika Kft

Nagysándor József u. 6-12
1201 Budapest
Tel: (+36 1) 421 47 10
Fax: (+36 1) 421 47 57
info-hu@lemo.com

ITALY

LEMO Italia srl

Viale Lunigiana 25
20125 Milano
Tel: (+39 02) 66 71 10 46
Fax: (+39 02) 66 71 10 66
sales.it@lemo.com

JAPAN

LEMO Japan Ltd

2-7-22, Mita,
Minato-ku, Tokyo, 108-0073
Tel: (+81 3) 54 46 55 10
Fax: (+81 3) 54 46 55 11
lemoinfo@lemo.co.jp

NETHERLANDS / BELGIUM

LEMO Connectors Benelux

De Trompet 1060
1967 DA Heemskerk
Tel. (+31) 251 25 78 20
Fax (+31) 251 25 78 21
info@lemo.nl

NORWAY / ICELAND

LEMO Norway A/S

Stanseveien 6B
0975 Oslo
Tel: (+47) 22 91 70 40
Fax: (+47) 22 91 70 41
info-no@lemo.com

SINGAPORE

LEMO Asia Pte Ltd

4 Leng Kee Road,
#06-09 SiS Building
Singapore 159088
Tel: (+65) 6476 0672
Fax: (+65) 6474 0672
sg.sales@lemo.com

SPAIN / PORTUGAL

IBERLEMO SAU

Brasil, 45, 08402 Granollers
Barcelona
Tel: (+34 93) 860 44 20
Fax: (+34 93) 879 10 77
info-es@lemo.com

SWEDEN / FINLAND

LEMO Nordic AB

Mariehällsvägen 39A
168 65 Bromma
Tel: (+46 8) 635 60 60
Fax: (+46 8) 635 60 61
info-se@lemo.com

SWITZERLAND

LEMO Verkauf AG

Grundstrasse 22 B
6343 Rotkreuz
Tel: (+41 41) 790 49 40
Fax: (+41 41) 790 49 43
ch.sales@lemo.com

UNITED KINGDOM

LEMO UK Ltd

12-20 North Street
Worthing, West Sussex,
BN11 1DU
Tel: (+44 1903) 23 45 43
Fax: (+44 1903) 20 62 31
lemouk@lemo.com

USA

LEMO USA Inc

P.O. Box 2408
Rohnert Park, CA 94927-2408
Tel: (+1 707) 578 88 11
(+1 800) 444 53 66
Fax: (+1 707) 578 08 69
info-US@lemo.com

LEMO DISTRIBUTORS

AUSTRALIA, CHILE, CZECH REPUBLIC, GREECE, INDIA, ISRAEL,
NEW ZEALAND, PAKISTAN, POLAND, RUSSIA, SOUTH AFRICA,
SOUTH KOREA, TAIWAN, TURKEY, UKRAINE

www.lemo.com



X-ON Electronics

Largest Supplier of Electrical and Electronic Components

Click to view similar products for [Circular Push Pull Connectors](#) category:

Click to view products by [LEMO](#) manufacturer:

Other Similar products are found below :

[FEA.1B.308.CYCD72Z](#) [D38999/20ZC8JA](#) [D38999/20ZG39BN](#) [D38999/20ZG41PN-LC](#) [D38999/20ZH21SA](#) [D38999/20ZH53SA](#)
[D38999/20ZJ24SA](#) [D38999/20ZJ29PA-LC](#) [D38999/20ZJ43HA](#) [D38999/20ZJ43PA-LC](#) [D38999/20ZJ61PA-LC](#) [D38999/24ZF11SA-LC](#)
[D38999/24ZF32BA](#) [D38999/24ZF32PA-LC](#) [D38999/24ZF32SA-LC](#) [D38999/24ZF35BA](#) [D38999/24ZF35SA-LC](#) [EXG.00.250.NTNY](#)
[FFA.00.250.CTAZ](#) [FFA.1S.302.CLAZ](#) [FFA.1Y.410.CTAC52](#) [FFA.2S.310.ZLA](#) [FFG.1B.302.CLAD52Z](#) [FFG.1B.304.CLAD42Z](#)
[FFG.1B.304.CLAD72Z](#) [FFG.1B.308.CLAD42Z](#) [FGA.1B.304.CLAD62Z](#) [FGA.1B.304.CYCD72Z](#) [FGA.1B.305.CLAD76](#)
[FGA.1B.306.CYCD72](#) [FGA.1B.307.CYCD72Z](#) [FGA.1B.308.CLAD76Z](#) [FGA.1B.308.CYCD42Z](#) [FGA.1B.308.CYCD52Z](#)
[FGA.1B.308.CYCD72Z](#) [FGA.1B.310.CLAD42](#) [FGA.1B.310.CLAD52Z](#) [FGA.1B.316.CLAD42](#) [FGA.1B.316.CLAD62Z](#)
[FGA.1B.316.CLAD76](#) [FGB.0B.307.CYCD31Z](#) [FGB.1B.302.CLAD72](#) [FGB.1B.303.CYCD62](#) [FGB.1B.305.CLAZ](#) [FGB.1B.307.CYCD62Z](#)
[FGB.1B.316.CLAD42](#) [FGC.0B.309.CLAD56](#) [FGC.1B.304.CLAD52Z](#) [FGC.1B.305.CLAD52Z](#) [FGC.1B.308.CLAD42](#)