

**Roundline Cylinders
Magnetic Piston
Double Acting
Ø 8 to 63 mm**

**Three different basic versions provide flexibility
and wide range of application**

**Magnetic piston as standard provides a wide range
of control options**

Comprehensive range of standard stroke lengths

International series available world-wide



Technical data

Medium:

Compressed air, filtered, lubricated or non-lubricated

Operation:

Double acting with buffer cushioning

Versions:

RT/57200/M: cylinder Ø 8 to 63 mm

RM/57200/M: cylinder Ø 20 to 63 mm

R./57200/M: integral eye mounting

R./57200/MC: central rear port, flat end

R./57200/MF: side port, flat end

Operating pressure:

1 to 10 bar

Operating temperature:

80°C max.

(consult our Technical Service for use below +2°C)

Cylinder diameters:

8, 10, 12, 16, 20, 25, 32, 40, 50, 63 mm

Standard strokes:

See page 2

Materials:

Piston rod: stainless steel (8 to 16 mm bore austenitic,
20 to 63 mm bore martensitic)

End covers: aluminium

Barrel: stainless steel (austenitic)

(Ø 8 to 16 mm martensitic, Ø 20 bis 63 mm austenitic)

Wiper: polyurethane

Seals and 'O'-rings: nitrile rubber

Ordering information

See page 2

Mountings and switches

See page 3

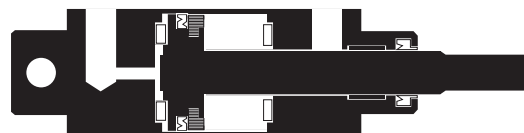
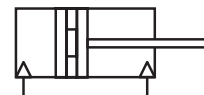

Cylinder variants

Symbol	Model	Description	Dimensions page
	R./57200/M	Standard cylinder, Ø 8 to 40 mm, integral eye mounting, Ø 50 and 63 mm	5+6
	R./57200/MC	Standard cylinder, central rear port, flat end	5
	R./57200/MF	Standard cylinder, side port, flat end	5
	R.57200/JM	Double ended piston rod, Ø 16 to 63 mm	6

Options selector

RT/572★★/★★/★★

Cylinder Ø (mm)	Ports
8	M3
10	M5
12	M5
16	M5
20	Rc1/8
25	Rc1/8
32	Rc1/8
40	Rc1/8
50	Rc1/4
63	Rc1/4

Stroke (mm)
500 max.

Cylinder variants	Substitute
Magnetic piston	M
Magnetic piston, central rear port, flat end	MC
Magnetic piston, side port, flat end	MF
Magnetic piston, double ended piston rod	JM

Cylinder Ø (mm)	Substitute
8	08
10	10
12	12
16	16
20	20
25	25
32	32
40	40
50	50
63	63

RM/572★★/★★/★★

Cylinder Ø (mm)	Ports
20	M6
25	M6
32	G1/8
40	G1/8
50	G1/4
63	G1/4

Stroke (mm)
500 max.

Cylinder variants	Substitute
Magnetic piston	M
Magnetic piston, central rear port, flat end	MC
Magnetic piston, side port, flat end	MF
Magnetic piston, double ended piston rod	JM

Cylinder Ø (mm)	Substitute
20	20
25	25
32	32
40	40
50	50
63	63

Ordering examples

Cylinder
 To order a basic Ø 40 mm (integral eye mounting), stroke 50 mm
quote: RM/57240/M/50

Cylinder
 To order a Ø 25 mm bore cylinder (central rear port in the end cover), stroke 200 mm
quote: RM/57225/MC/200

Standard strokes

Cylinder Ø	Stroke length (mm)										
	10	25	40	50	80	100	125	160	200	250	320
8	•	•	•	•	•	•					
10	•	•	•	•	•	•					
12	•	•	•	•	•	•	•	•			
16	•	•	•	•	•	•	•	•	•		
20	•	•	•	•	•	•	•	•	•	•	•
25	•	•	•	•	•	•	•	•	•	•	•
32	•	•	•	•	•	•	•	•	•	•	•
40	•	•	•	•	•	•	•	•	•	•	•
50	•	•	•	•	•	•	•	•	•	•	•
63	•	•	•	•	•	•	•	•	•	•	•

Theoretical forces, air consumption









Cylinder Ø	Theoretical forces (N) at 6 bar		Air consumption (l/cm stroke) at 6 bar	
	outstroke	instroke	outstroke	instroke
8	30	25,9	0,004	0,003
10	46,8	39,6	0,005	0,004
12	67,8	60	0,008	0,006
16	120	103	0,014	0,013
20	188	158	0,022	0,019
25	294	247	0,035	0,02
32	482	414	0,056	0,048
40	754	661	0,087	0,074
50	1178	1057	0,137	0,114
63	1870	1680	0,218	0,195

Switches

Type Reed	With cable		With connector (M8x1)		Current max.	Temperature °C	LED	Features	Cable/ connector length	Cable type	Cable with connector	Datasheet
	Solid state	Voltage V a.c.	V d.c.	V d.c.								
M/50/LSU/*V	–	10 to 240	10 to 170	180 mA	-20 to +80	•	–	–	2, 5, 10 m	PVC 2 x 0,25	–	N/UK 4.3.005
M/50/LSU/5U	–	10 to 240	10 to 170	180 mA	-20 to +80	•	–	–	5 m	PUR 2 x 0,25	–	N/UK 4.3.005
TM/50/RAU/2S	–	10 to 240	10 to 170	180 mA	-20 to +150	–	–	–	2 m	Silicone 2 x 0,25	–	N/UK 4.3.005
M/50/RAC/5V	–	10 to 240	10 to 170	180 mA	-20 to +80	–	Changeover	–	5 m	PVC 3 x 0,25	–	N/UK 4.3.005
M/50/LSU/CP	–	10 to 60	10 to 75	180 mA	-20 to +80	•	Plug M8x1	–	5 m	PVC 3 x 0,25	M/P73001/5	N/UK 4.3.005
–	M/50/EAP/*V	–	10 to 30	150 mA	-20 to +80	•	PNP	–	2, 5, 10 m	PVC 3 x 0,25	–	N/UK 4.3.007
–	M/50/EAP/CP	–	10 to 30	150 mA	-20 to +80	•	PNP, plug M8x1	–	5 m	PVC 3 x 0,25	M/P73001/5	N/UK 4.3.007
–	M/50/EAP/CC	–	10 to 30	150 mA	-20 to +80	•	PNP, plug M12x1	–	5 m	PVC 3 x 0,25	M/P34614/5	N/UK 4.3.007
–	M/50/EAN/*V	–	10 to 30	150 mA	-20 to +80	•	NPN	–	2, 5, 10 m	PVC 3 x 0,25	–	N/UK 4.3.007
–	M/50/EAN/CP	–	10 to 30	150 mA	-20 to +80	•	NPN, plug M8x1	–	5 m	PVC 3 x 0,25	M/P73001/5	N/UK 4.3.007

* Please insert cable length
Further information (technical data, cable material, dimensions) see datasheet.

Mountings

	Style AK	Style C	Style F	Style H	Style L	Style N	Style N2
							
	7	2	8	13	1	3	4
Cylinder Ø	Page 6	Page 6	Page 6	Page 8	Page 6	Page 6	Page 6
8	–	M/P71273/1	QM/57008/25	–	QM/57008/24	M/P71364	M/P1500/111
10	QM/8010/38	M/P71273/2	QM/8010/25	–	QM/947	M/P71364	M/P1501/80
12	QM/8010/38	M/P71273/2	QM/8010/25	–	QM/947	M/P71364	M/P1501/80
16	QM/8012/38	M/P19369	QM/57016/25	–	QM/946	M/P1501/90	M/P1501/79
20	QM/8020/38	M/P19389	QM/57020/25	–	QM/8012/24	M/P13834	M/P1501/60
25	QM/8025/38	M/P40381	QM/57025/25	–	QM/57025/25	M/P13607	M/P1501/89
32	QM/8025/38	M/P19406	QM/57032/25	–	QM/8020/24	M/P13615	M/P1501/89
40	QM/8040/38	M/P71273/3	QM/57040/25	–	QM/57040/24	M/P29254	M/P1501/90
50	QM/8040/38	QM/57050/21	QM/57040/25	QM/55240/28	QM/57050/24	–	M/P1501/90
63	QM/8050/38	QM/57063/21	QM/57063/25	QM/55250/28	QM/57063/24	–	M/P1501/91
	Style UF	Bracket for switch M/50					
							
	6	≥ 15 mm stroke		< 15 mm stroke			
		9	10				
Cylinder Ø	Page 7	Page 7	Page 7				
8	–	–	–				
10	QM/8010/32	QM/33/010/22	QM/33/010/23				
12	QM/8010/32	QM/33/012/22	QM/33/016/23				
16	QM/8012/32	QM/33/016/22	QM/33/016/23				
20	QM/8020/32	QM/33/020/22	QM/33/020/23				
25	QM/8025/32	QM/33/025/22	QM/33/025/23				
32	QM/8025/32	QM/33/032/22	–				
40	QM/8040/32	QM/33/040/22	–				
50	QM/8040/32	QM/33/050/22	–				
63	QM/8050/32	QM/33/063/22	–				

Ø 8 to 40 mm

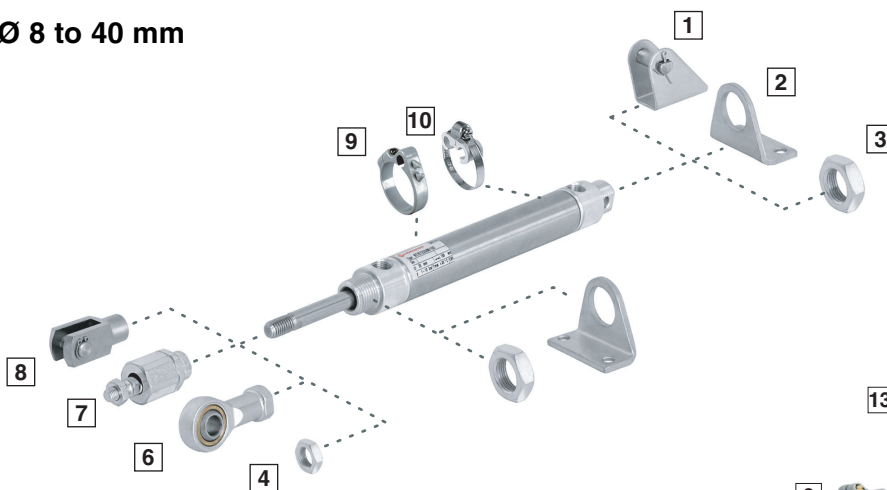

Ø 50 and 63 mm

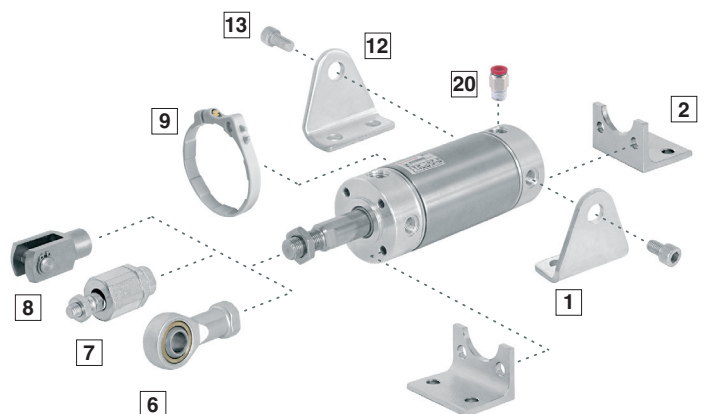

**Ø 8 to 12 mm
RT/57200/M**

RT/57200/MC

RT/57200/MF

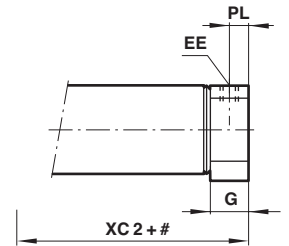
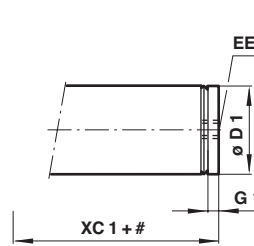
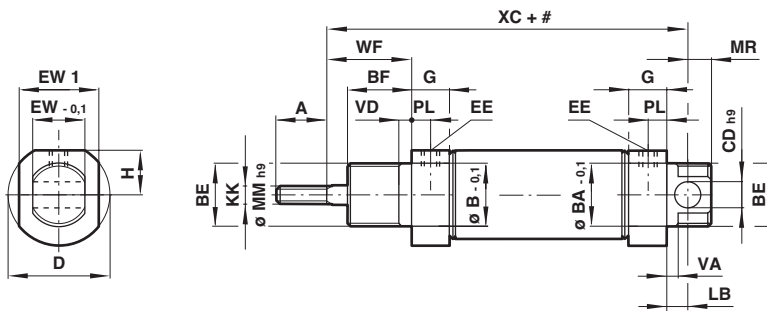

**Ø 16 to 40 mm
R./57200/M**

R./57200/MC

R./57200/MF

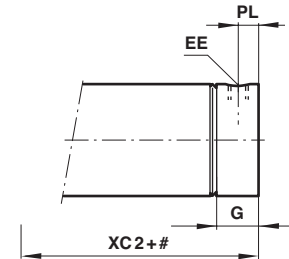
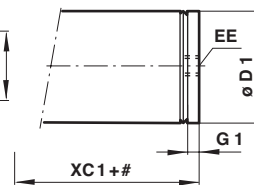
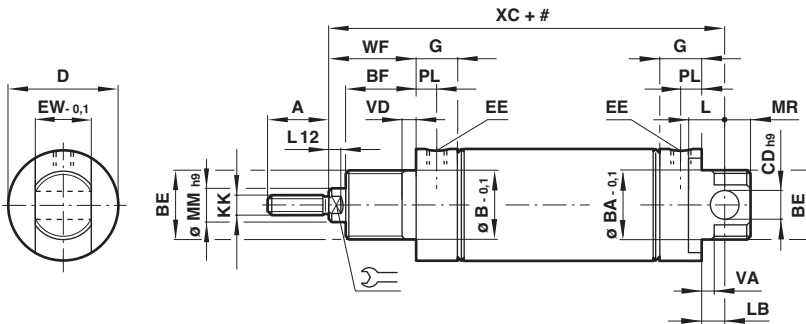

Stroke

Model	Ø	A	Ø B/ Ø BA	BE	BF	Ø CDh9	Ø D	Ø D1	EE RT/57...	EE RM/57...	EW-0,1	EW1	G	G1	H
RT/57208/M.	8	8	10	M10 x 1	7,5	3	12	9,5	M3	M3	6	10	7,5	3	5
RT/57210/M.	10	9	10	M10 x 1	8	4	15	11,5	M5	M5	8	12,5	9,5	4,5	6,5
RT/57212/M.	12	9	10	M10 x 1	8	4	15	13	M5	M5	8	-	9,5	4,5	6,5
RT/57216/M.	16	12	12	M12 x 1,25	10	5	17,5	17,5	M5	M5	10	-	11,5	4	-
R./57220/M.	20	14	16	M16 x 1,5	12	6	22	21,5	Rc 1/8	M6	12	-	15,5	8	-
R./57225/M.	25	16	18	M18 x 1,5	12	8	26,5	26,5	Rc 1/8	M6	14	-	15,5	8	-
R./57232/M.	32	22	22	M22 x 1,5	15	8	33,5	33,5	Rc 1/8	G 1/8	16	-	17,5	5,5	-
R./57240/M.	40	23	30	M30 x 1,5	15	10	41,5	41,5	Rc 1/8	G 1/8	20	-	18	5,5	-
Model	KK	L	LB	L12	Ø MMh9	MR	PL		VA/VD	WF	XC	XC1	XC2	kg bei 0 mm	kg per 25 mm
RT/57208/M.	M3	-	4,5	-	3	3	4	-	1,5	8,5	48	39	43,5	0,02	0,02
RT/57210/M.	M4	-	5	-	4	4	5,5	-	1,5	10	54	44	49	0,02	0,03
RT/57212/M.	M4	-	5	-	4	4	5,5	-	1,5	10	54	44	49	0,02	0,03
RT/57216/M.	M6	-	7	5	6	5	5,5	5	2	13,5	64,5	50	57,5	0,04	0,05
R./57220/M.	M8	-	7	5	8	6	9	7	3	15,5	75,5	61	68,5	0,08	0,07
R./57225/M.	M10 x 1,25	-	9	5	10	8	9	9	3	16,5	78,5	62	69,5	0,12	0,11
R./57232/M.	M10 x 1,25	12	7	5	12	8	9	10	3	23	93	74	86	0,21	0,16
R./57240/M.	M12 x 1,25	14	5	6	14	10	10	12	3	24	96	78,5	91	0,33	0,20

Ø 50 and 63 mm
R./57200/M

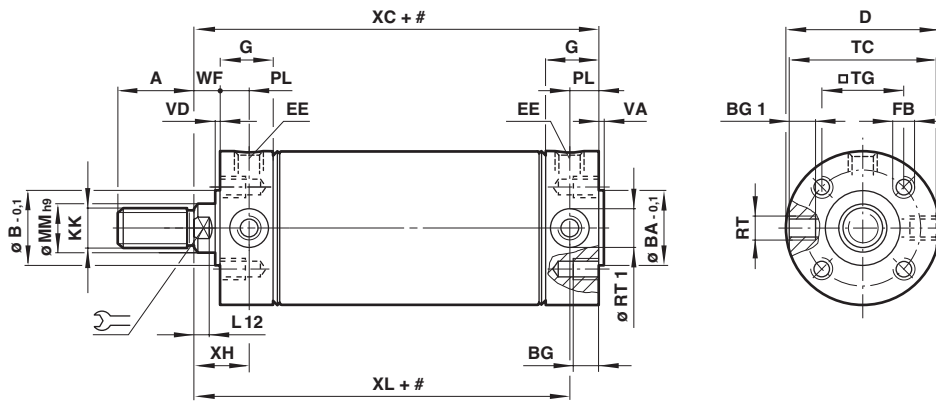

Model	Ø	A	Ø B/BA-0,1	BG	BG 1	Ø D	EE RT/57...	EE RM/57...	FB	G	KK	Ø MM h9	PL
R./57250/M	50	23	28	12	8	52,5	Rc 1/4	G 1/4	M 6	22	M 12 x 1,25	16	13
R./57263/M	63	30	35	12	9,5	65,5	Rc 1/4	G 1/4	M 8	22	M 16 x 1,5	20	13

Model	Ø	RT	RT 1	SW	TG	TC	VA/VD	WF	XH	XL	at 0 mm	per 100 mm
R./57250/M	50	M 10 x 1	13	13	28,5	49	2	13	26	84	0,39 kg	0,31 kg
R./57263/M	63	M 12 x 1,5	15	17	35,5	62	2	13	26	86	0,89 kg	0,44 kg

R./57200/JM

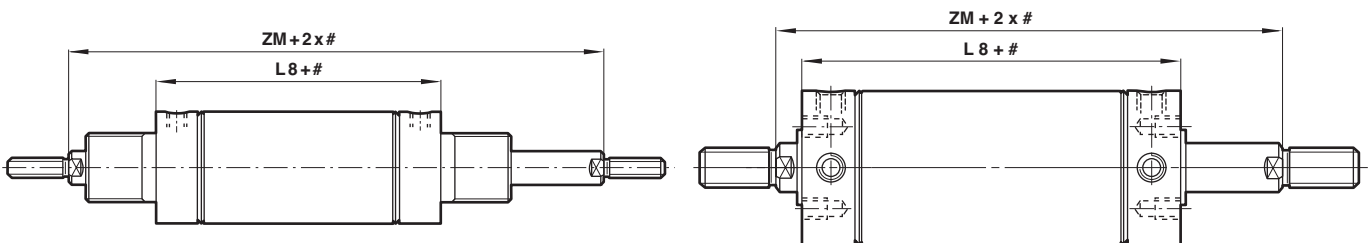

Model	Ø	L 8	ZM
R./57216/JM	16	44	71
R./57220/JM	20	53	84
R./57225/JM	25	53	86
R./57232/JM	32	63	109
R./57240/JM	40	67	115
R./57250/JM	50	84	110
R./57263/JM	63	86	112

Stroke

Mountings

Piston rod swivel mounting AK, ISO 8139

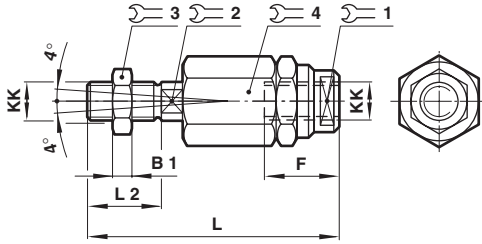

Type	Ø	KK	B1	F	L	L2	1	2	3	4	kg
QM/8010/38	10/12	M 4	2	12,5	33	8	11	3,2	7	11	0,01
QM/8012/38	16	M 6	3	14	39	12	7	5	10	13	0,02
QM/8020/38	20	M 8	4	18	55	16	10	7	13	17	0,05
QM/8025/38	25/32	M 10x1,25	5	26	73	20	19	12	17	30	0,20
QM/8040/38	40/50	M 12x1,25	6	26	77	24	19	12	19	30	0,20
QM/8050/38	63	M 16x1,5	8	34	106	32	30	19	24	42	0,65

Foot mounting, ISO 6431

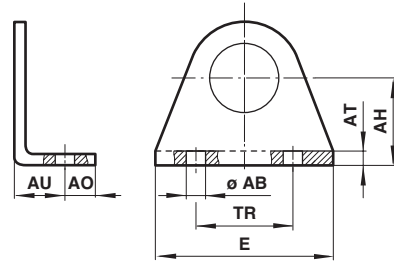

Type	Ø	Ø AB	AH	AO	AT	AU	E	TR	kg
M/P71273/1	8	3,8	10	3,5	1,5	7,5	25	18	0,01
M/P71273/2	10/12	5	12	4,5	1,5	7,5	30	20	0,01
M/P19369	16	4,5	16	6	2	10	35	25	0,02
M/P19389	20	5,5	20	6	3	13	43	32	0,03
M/P40381	25	6,6	22	8	3	12,5	49	38	0,04
M/P19406	32	6,6	25	7,5	4	16	53	40	0,06
M/P71273	40	7	28	7	4	16	66	52	0,08
QM/57050/2	150	9	40	10	4	17	52	36	
QM/57063/2	163	9	47	10	5	19	61	45	

Piston rod clevis mounting F, ISO 8140

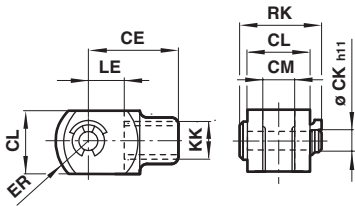

Type	Ø	KK	CE	Ø CK h11	CL	CM	ER	LE	RK	kg
QM/57008/25	8	M3	11	3	6	3	4,5	5	10,5	0,01
QM/8010/25	10/12	M4	16	4	8	4	6,5	8	11,5	0,01
QM/57016/25	16	M6	20	5	10	5	8	10	14,5	0,01
QM/57020/25	20	M8	24	6	12	6	9,5	12	17,5	0,02
QM/57025/25	25	M10x1,25	26	8	14	7	11,5	12	20,5	0,04
QM/57032/25	32	M10x1,25	32	8	16	8	13	16	22,5	0,05
QM/57040/25	40	M12x1,25	40	10	20	10	16	20	29	0,09
QM/57040/25	50	M 12x1,25	48	12	24	12	19	24	33	
QM/57063/25	63	M 16x1,5	56	14	27	14	21	28	36,5	

Rear hinge mounting L

for Ø 8 to 40 mm

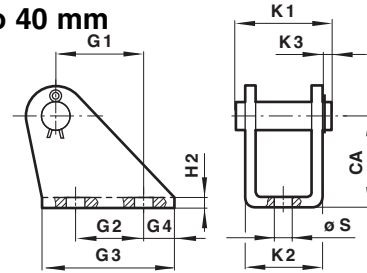

for Ø 50 and 63 mm

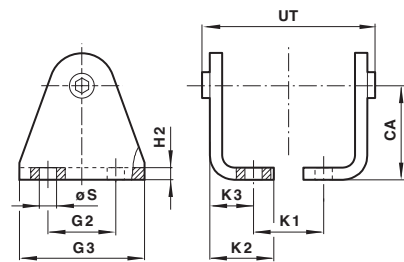

Central trunnion H

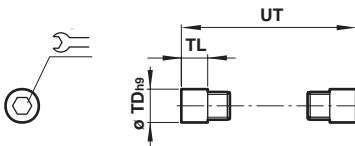

Type	Ø	Ø TD h9	TL	UT	kg
QM/55240/28	50	12	9,5	63	0,03
QM/55250/28	63	14	11	76	0,05

Type	Ø	CA	G1	G2	G3	G4	H2	K1	K2	K3	Ø S	UT	kg
QM/57008/24	8	10	9	7	14	3,5	1	-	8	-	3,5	-	0,01
QM/947	10/12	12	6,5	-	15	6	1	13,5	10,5	2	4,8	-	0,01
QM/946	16	16	13	10	22	6	1,5	-	12,5	-	4,8	-	0,02
QM/8012/24	20	20	18,5	15	30	8	1,5	20	15	3	5,5	-	0,02
QM/57025/25	25	22	20	15	33	9	2	-	18	-	6,6	-	0,04
QM/8020/24	32	25	20	15	35	10	2	25	20,5	3	6,6	-	0,04
QM/57040/25	40	28	25	20	42	11	3	-	26	-	7	-	0,09
QM/57050/24	50	40	-	30	54	-	4	30,5	24	15	9	68	0,20
QM/57063/24	63	47	-	40	64	-	5	40,5	26,5	17,5	9	84	0,32

Nut N

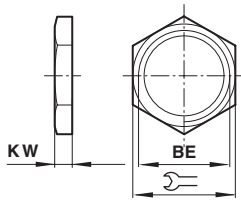

Type	Ø	BE		KW	kg
M/P71364	8...12	M10x1	14	4	0,01
M/P1501/90	16	M12x1,25	19	6	0,01
M/P13834	20	M16x1,5	22	5	0,01
M/P13607	25	M18x1,5	24	5	0,01
M/P13615	32	M22x1,5	27	8	0,02
M/P29254	40	M30x1,5	36	8	0,03

Nut N2

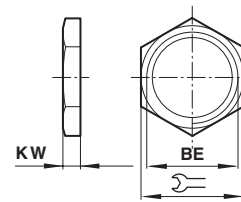

Type	Ø	BE		KW	kg
M/P1500/111	8	M3	6	2	0,01
M/P1501/80	10/12	M4	7	2	0,01
M/P1501/79	16	M6	10	3	0,01
M/P1501/60	20	M8	13	4	0,01
M/P1501/89	25/32	M10x1,25	17	5	0,01
M/P1501/90	40/50	M12x1,25	19	6	0,01
M/P1501/91	63	M16x1,5	24	8	0,02

Universal piston rod eye UF

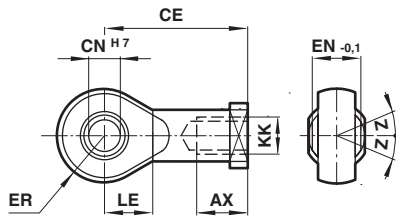

Type	Ø	KK	AX	CE	Ø CN H7	EN -0,1	ER	LE	Z	kg
QM/8010/32	10/12	M4	14	27	5	8	8	10	5°	0,02
QM/8012/32	16	M6	14	30	6	9	9	11	5°	0,02
QM/8020/32	20	M8	16	36	8	12	11	13	5°	0,05
QM/8025/32	25/32	M10x1,25	25	42	10	14	14	15	5°	0,08
QM/8040/32	40	M12x1,25	22	50	12	16	16	17	5°	0,12
QM/8040/32	50	M12x1,25	22	50	12	16	19	17	13°	
QM/8050/32	63	M16x1,5	28	64	16	21	21	22	15°	

Bracket mounting for > 15 mm stroke

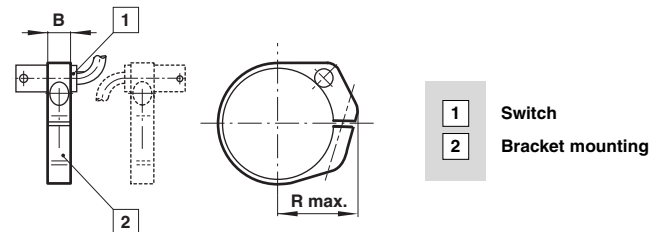

Type	Ø	B	R max.	kg
QM/33/010/22	10	8	16	0,01
QM/33/012/22	12	8	18	0,01
QM/33/016/22	16	10	20	0,01
QM/33/020/22	20	10	22	0,01
QM/33/025/22	25	10	24	0,01
QM/33/032/22	32	10	29	0,01
QM/33/040/22	40	10	32	0,01
QM/33/050/22	50	10	38	0,01
QM/33/063/22	63	10	46	0,01

Bracket mounting for < 15 mm stroke

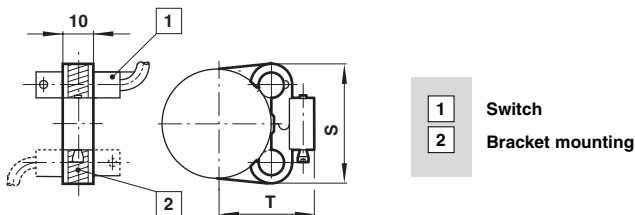

Type	Ø	S	T	kg
QM/33/010/23	10	27,5	19,5	0,01
QM/33/016/23	12	28,5	21,5	0,01
QM/33/016/23	16	29,5	23,5	0,01
QM/33/020/23	20	29,5	26	0,01
QM/33/025/23	25	31,5	28,5	0,01

Warning

These products are intended for use in industrial compressed air systems only. Do not use these products where pressures and temperatures can exceed those listed under 'Technical Data'.

Before using these products with fluids other than those specified, for non-industrial applications, life-support systems, or other applications not within published specifications, consult NORGREN.

Through misuse, age, or malfunction, components used in fluid power systems can fail in various modes.

The system designer is warned to consider the failure modes of all component parts used in fluid power systems and to provide adequate safeguards to prevent personal injury or damage to equipment in the event of such failure.

System designers must provide a warning to end users in the system instructional manual if protection against a failure mode cannot be adequately provided.

System designers and end users are cautioned to review specific warnings found in instruction sheets packed and shipped with these products.

X-ON Electronics

Largest Supplier of Electrical and Electronic Components

Click to view similar products for [Switch Actuators](#) category:

Click to view products by [Norgren](#) manufacturer:

Other Similar products are found below :

[LW1B-M0](#) [61-1330.0](#) [61-2607.0/D](#) [680-4000-00](#) [704.012.618](#) [704.411.018I](#) [704.412.0](#) [704.633.1](#) [704.730.1](#) [704.733.0](#) [84-1221.7](#) [862.8102](#) [G6083](#)
[9PA24](#) [120-1867-000](#) [ADC-418G](#) [12MA7](#) [HW1M-L2222](#) [200-.704-00](#) [JS-10008](#) [JS-10083](#) [JS-10118](#) [JS-10133](#) [JS-10277](#) [JS-10389](#) [JS-116](#) [JS-](#)
[150](#) [JS-555](#) [JS-68](#) [JS-6-B](#) [JS-91](#) [JS-94](#) [22-211.011](#) [9001KXSDC](#) [KRR22NW3XX03](#) [92-458.500](#) [SAPT654133](#) [2PA3](#) [STKLBU](#) [STKLWH](#)
[SW53AA2](#) [CIR030FP-36-10S-F80-26](#) [302561](#) [3E-10.4](#) [3E-12.0](#) [468-10243-001](#) [51-030.002](#) [51-030.005](#) [351-1640-000](#) [JM-13](#)