

Microswitches MK series



Microswitches MK series

Introduction



Microswitches of MK series have been developed in order to add new features to traditional and tested microswitches of Pizzato Elettrica (cross-reference at page 13). These new products have been designed with shapes and fixing perfectly interchangeable with the previous ones and with various additional functions useful to extend the applicatory field.

The main innovation of this series is the tripping device evolved and modern, with qualitative features higher than solutions present on the market.

The electrical contact on new microswitch has been realized with higher reliability technology, thanks to the double and redundant shape, and has the possibility to carry out operations with positive opening.

The housing of the new microswitch provides the possibility to seat gaskets in order to seal the device against fine dusts or liquids up to IP65 degree.

Fastening terminals of conductors are more practical and allow the fixing of different diameter cables or the possibility to choice different bends of faston contacts. For high quantity it's possible to supply the microswitch only with the contact NO or NC, in order to minimize purchase costs.

Contact block reliability

In the following table we refer to the typical microswitch contact structure (type A) normally used in the industry, compared with the innovative solution that Pizzato Elettrica uses in new MK series microswitches: movable contact with single interruption and double contacts (type B).

As you can see from the table below, this last structure (type B) offers half of the contact resistance (R) than the simple mobile contact (type A) and a lower probability of failure (fe).

In fact, defined x the probability of a commutation failure of a single interruption, it results that in the type A the failure probability $fe=x$, in the type B the probability $fe= x^2$. This means that if in a certain situation the failure probability x is equal, for instance, to 1×10^{-4} (1 failed interruption every 10.000), we will have:

- in type A one failed commutation every 10.000
- in type B one failed commutation every 100.000.000

Type	Figure	Description	Contact resistance R	Probability of failure fe
A Common microswitch		Contacts with single interruption	$R=R_c$	$fe=x$
B Pizzato microswitch MK series		Contacts with single interruption and double contacts	$R=R_c/2$	$fe \cong x^2$

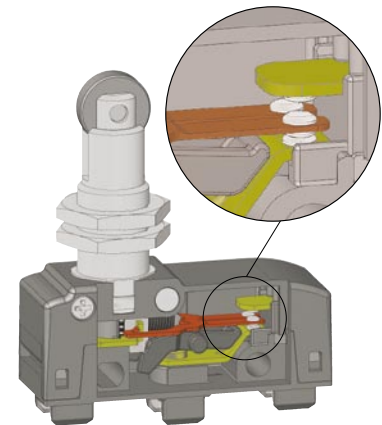

Extended temperature range

-40°C

On request, on new MK series are available the versions with extended temperature range. Differently from standard MK microswitches with temperature range from +85 C° to -25 C°, these special versions can be used in places where the ambient temperature changes from +85 C° to -40 °C.

They can be installed inside cold stores, sterilizers or other equipment with very low ambient temperature. Special materials that have been used to realize these versions, maintain unchanged their features also in these conditions, widening the installation possibilities.

Microswitches for safety applications

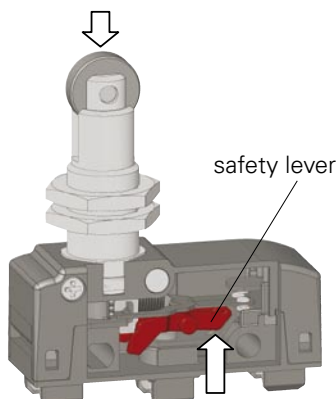

All microswitches that have the symbol \ominus beside the code are with positive opening, therefore suitable for safety applications.

These microswitches are provided with a rigid connection between push button and NC contacts, which are opened by force through a strong/sturdy internal safety lever.

The positive opening has been realised in conformity with the standard IEC 947-5-1, enclosure K, therefore these microswitches are suitable for the installation for people's protection.

Protection degree IP65

By installing microswitches MK ●●2●● with terminal covers VF MKC●22 or terminal covers VF MKC●23, it's possible to obtain a microswitch fully dust proof and waterproof.

Thanks to special rubber gaskets anti-oil, we achieve the protection degree IP65.

For application with high presence of dirtiness, are available also versions with double gasket in the push button (internal + external). ex. MK ●●2●12 or MK ●●2●13.

- Gaskets
- Microswitch: MKV12D12
- Terminal cover: VF MKCV22

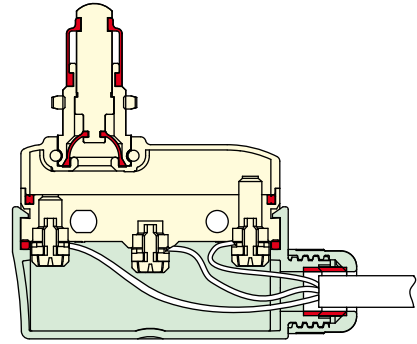

Clamping screw plates for different diameter cables (MK V●)

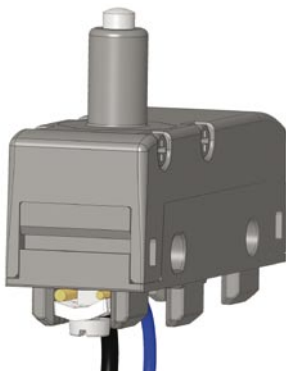

These clamping screw plates have a particular "roofing tile" structure and are connected loosely to the clamping screw. In this way, during the wires fixing, the clamping screw plate is able to suit to cables of different diameter (see picture) and tends to tighten the wires toward the screw instead of permitting them to escape towards the outside.

Terminal covers with wire trap cable gland side by side

New terminal covers supplied with wire trap cable gland are provided for the protection degree up to IP65.

These terminal covers are snap-in assembled and they have small dimensions in the microswitch profile, it's possible to install them also on microswitches fixed side by side. See page 12.

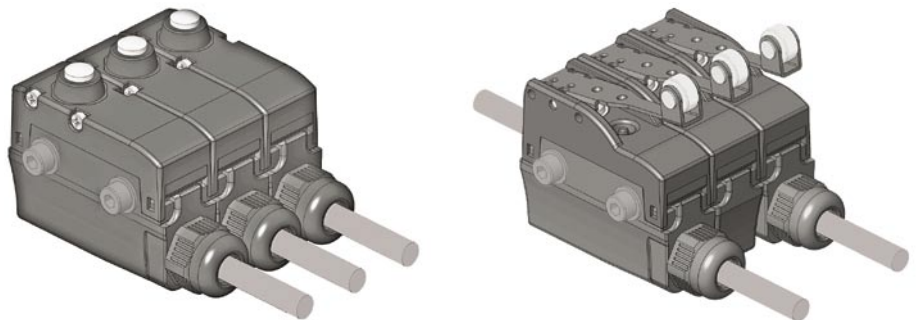

Rotating actuators



Thanks to the new lateral fixing system patented, it's possible to rotate the roller of microswitches MK ●●●15 and MK ●●●17 in 90° steps.

The lateral fixing allows to disconnect the actuator from the body also when the actuator is already fixed to the racket. The flexibility of the product allows also to unify items on stock for applications that require roller both longitudinal or transversal.

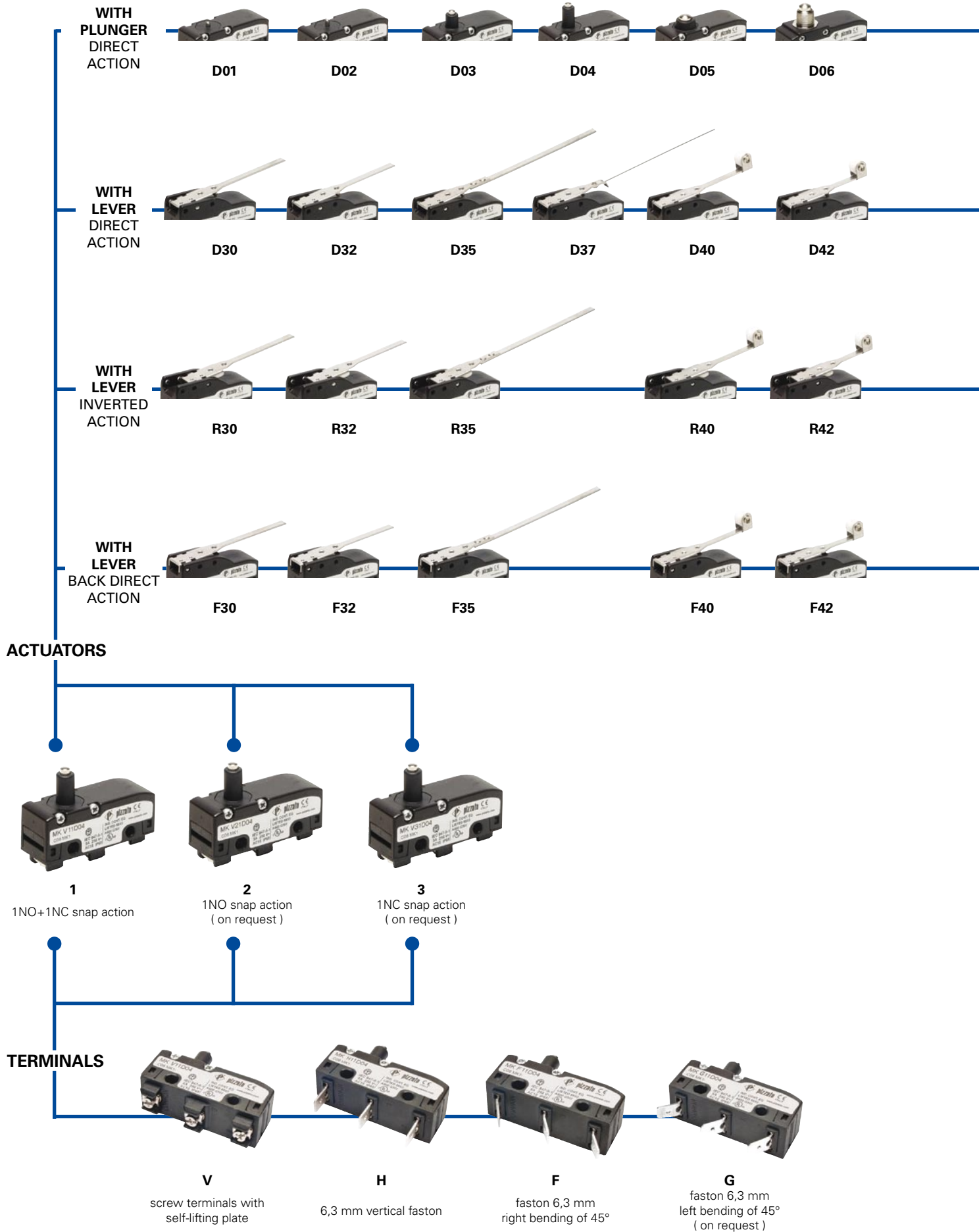



D08 **D09** **D10** **D12** external rubber gasket **D13** external rubber gasket **D15** **D17**



D45 **D47** **D53** **D59** **D49**



R45 **R47** **R53** **R59** **R60**



F45 **F47** **F53** **F59** **F49**

Code structure

Attention! The feasibility of a code number does not mean the effective availability of a product. Please contact our sales office.

MK V12D40-GR16T6

Terminals type		Ambient temperature	
V	screw terminals with self-lifting late		-25°C ... +85°C (standard)
H	vertical faston terminals	T6	-40°C ... +85°C
F	with faston, right bending of 45°	Suffix	
G	with faston, left bending of 45° (on request)		no suffix (standard)
Contact block		R16	Ø 9,5x4 mm metal roller (for actuator 40, 42 ,45 47, 53, 59)
1	1NO+1NC, snap action	R10	Ø 9,8x8,4 mm polymer roller (for actuator 40, 42 ,45, 53)
2	1NO, snap action (on request)	Contacts type	
3	1NC, snap action (on request)		silver contacts (standard)
Max protection degree		G	silver contacts gold plated 1 µm
1	IP40 (with protection)	Actuator	
2	IP65 (with protection)	01	with pin
Actuation type		02	with pin
D	direct action	03	with small push button
R	inverted action
F	back direct action		



Main data

- Polymer housing
- Protection degree IP20, IP40 or IP65
- 4 terminal types available
- 47 actuators available
- Versions with positive opening ⊕
- Silver contacts gold plated versions
- Terminal covers with wire trap cable gland

Markings and quality marks:



Technical data

Housing

Made of glass-reinforced polymer, self-extinguishing, shock-proof thermoplastic resin.

Protection degree: IP20 (with protection VF C01 - VF C03)
IP40 (with protection VF MKC•1• - VF C02)
IP65 (with protection VF MKC•22 - VF MKC•23)

General data

Ambient temperature: from -25°C to +85°C
Max operating frequency: 3600 operations cycles¹/hour
Mechanical endurance: 10 million operations cycles¹
(1) One operation cycle means two movements, one to close and one to open contacts, as foreseen by IEC 947-5-1 standard.

Cross section of the conductors (flexible copper wire)

MK series:	min.	1 x 0,34 mm ²	(1 x AWG 22)
	max.	2 x 1,5 mm ²	(2 x AWG 16)

In conformity with standards:

IEC 947-5-1, IEC 337-1, EN 60947-5-1, CEI EN 60947-5-1, CEI 17-45, CEI 23-11, IEC 529, EN 60529, CEI 70-1

In conformity with requirements requested by:

Low Voltage Directive 73/23/EEC and subsequent modifications and completions.
Machinery Directive 98/37/EEC.

Electromagnetic Compatibility 89/336/EEC and subsequent modifications and completions.

Positive contact opening in conformity with standards:

IEC 947-5-1, EN 60947-5-1, CEI EN 60947-5-1, VDE 0660-206.

Installation for safety applications:

Use only switches marked with the symbol ⊕. The safety circuit must always be connected with the **NC contacts** (normally closed contacts) as stated in the **standard CEI EN 60947-5-1, encl. K, par. 2**. The switch must be actuated with **at least up to the positive opening travel (FAP)** near the code article. The switch must be actuated **at least with the positive opening force (CAP)**, near the code article.

⚠ For the correct installation of all articles, please see "Utilization requirements" chapter, from page 6/1 to page 6/4 of general catalog 2005/2006

Electrical data

Thermal current (I _{th}):	16 A
Rated insulation voltage (U _i):	250 VAC 300 VDC
Protection against short circuits:	fuse 10 A 500 V type gG
Pollution degree:	3

Utilization categories

Alternate current: AC15 (50 ... 60 Hz)			
U _e (V)	250		
I _e (A)	5		
Direct current: DC13			
U _e (V)	24	125	250
I _e (A)	4	1,1	0,4

Data type approved by UL

Utilization categories Q300 (69 VA, 125-250 VDC)
A300 (720 VA, 120-300 VAC)
In conformity with standard: UL 508

Please contact our technical service for the list of type approved products.

Terminals outline dimension

All measures in the drawings are in mm

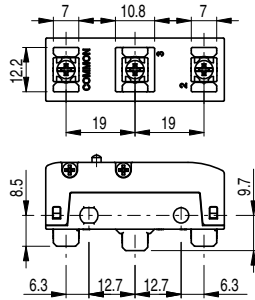

Screw terminals **V** with plate

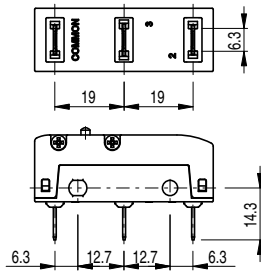

Vertical faston **H** terminals

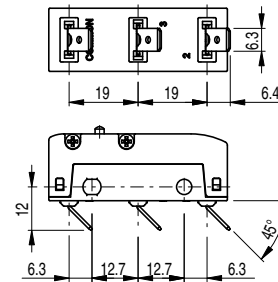

faston terminals **F**, right bending

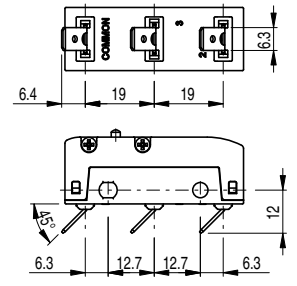

faston terminals **G**, left bending (on request)

Note: H vertical faston terminals can be bent according to one's installation requirements.

We recommend to bend the faston with an angle not higher than 45° and to carry out this operation no more than 5 times.

Driving torques



Tighten the nut **1** with a driving torque **2 ... 3 Nm**.

Tighten the screws **2** with a driving torque **0,5 ... 0,6 Nm**.



Tighten the nut **3** M4 with a driving torque **0,8 ... 1,2 Nm**, interposing a washer.

Attention: a driving torque higher than 1,2 Nm can cause the breaking of the microswitch.



Tighten the screws **4** with a driving torque **0,6 ... 0,8 Nm**.

Max and min. actuating speed

Type 1 Plunger

Vmax (m/s)	Vmin (mm/s)
0,5	0,05

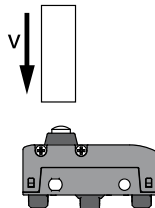

Type 2 Roller plunger

φ	Vmax (m/s)	Vmin (mm/s)
15°	0,6	0,2
30°	0,3	0,1
45°	0,1	0,05

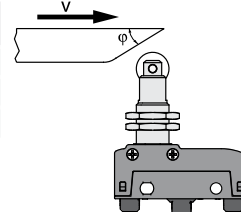

Type 3 Lever with direct action (D)

Vmax (m/s)	Vmin (mm/s)
0,03 x L	0,0166 x L

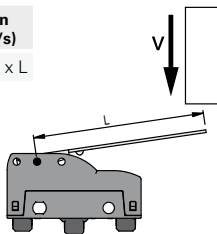

Type 4 Lever with inverted action (R)

Vmax (m/s)	Vmin (mm/s)
0,015 x L	0,0083 x L

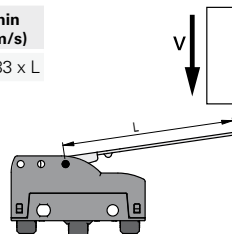

Type 5 Lever with back direct action (F)

Vmax (m/s)	Vmin (mm/s)
0,01 x L	0,0047 x L

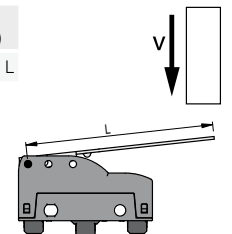

Type 6 Roller lever with direct action (D)

φ	Vmax (m/s)	Vmin (mm/s)
15°	0,1 x L	0,0664 x L
30°	0,05 x L	0,0332 x L
45°	0,03 x L	0,0166 x L

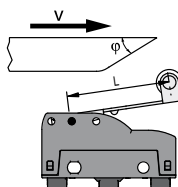

Type 7 Roller lever with inverted action (R)

φ	Vmax (m/s)	Vmin (mm/s)
15°	0,048 x L	0,0332 x L
30°	0,024 x L	0,0166 x L
45°	0,015 x L	0,0083 x L

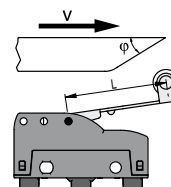

Type 8 Roller lever with back direct action (F)

φ	Vmax (m/s)	Vmin (mm/s)
15°	0,032 x L	0,0188 x L
30°	0,016 x L	0,0094 x L
45°	0,01 x L	0,0047 x L

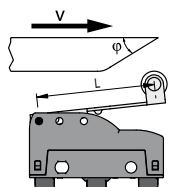

Microswitches MK series

Wire diagram

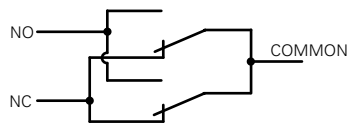

Contacts with single interruption and double contacts

With direct and back direct action (F, D)

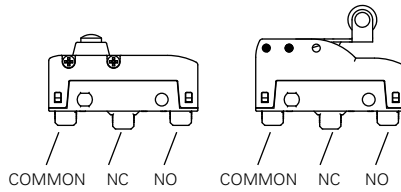

With inverted action (R)

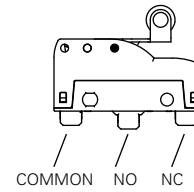

Legend

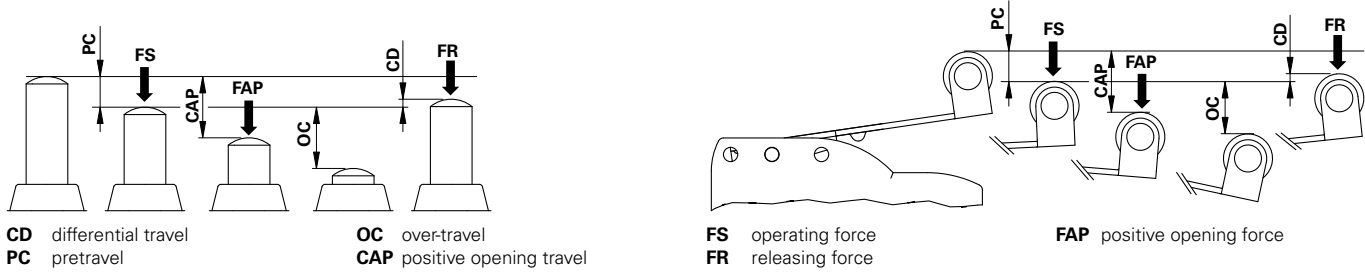

Microswitches with direct action (All measures in the drawings are in mm)

10 pcs packs

MK V11D01 1NO+1NC PC 0,5 mm FS 4 N OC 1,5 mm FR 3 N CD 0,05 mm	MK V11D02 1NO+1NC PC 0,5 mm FS 4 N OC 2 mm FR 3 N CD 0,05 mm
Max and min. speed page 6 - type 1	
MK V11D03 1NO+1NC PC 0,5 mm FS 4 N OC 2 mm FR 3 N CD 0,05 mm	MK V11D04 1NO+1NC PC 0,5 mm FS 4 N OC 2 mm FR 3 N CD 0,05 mm
Max and min. speed page 6 - type 1	
MK V11D05 (in stock) 1NO+1NC PC 0,5 mm FS 4 N OC 2 mm FR 3 N CD 0,05 mm FAP 20 N CAP 2,2 mm	MK V11D06 (in stock) 1NO+1NC PC 0,5 mm FS 4 N OC 3 mm FR 3 N CD 0,05 mm FAP 20 N CAP 2,2 mm
Max and min. speed page 6 - type 1	

Items with code on the green background are available in stock

MK V11D08	PC 0,5 mm OC 5,5 mm CD 0,05 mm CAP 2,2 mm	FS 4 N FR 3 N FAP 20 N	MK V11D09	PC 0,5 mm OC 5,5 mm CD 0,05 mm CAP 2,2 mm	FS 4 N FR 3 N FAP 20 N
Max and min. speed page 6 - type 1			Max and min. speed page 6 - type 1		

MK V11D10	PC 0,5 mm OC 5,5 mm CD 0,05 mm CAP 2,2 mm	FS 4 N FR 3 N FAP 20 N	MK V11D12	PC 0,5 mm OC 5,5 mm CD 0,05 mm CAP 2,2 mm	FS 4,5 N FR 3 N FAP 20 N
Max and min. speed page 6 - type 1			Max and min. speed page 6 - type 1		

		<p>Fixed only by threaded head</p>			
MK V11D13	PC 0,6 mm OC 5,4 mm CD 0,05 mm CAP 2,2 mm	FS 6 N FR 4 N FAP 20 N	MK V11D15	PC 0,5 mm OC 5,5 mm CD 0,05 mm CAP 2,2 mm	FS 4 N FR 3 N FAP 20 N
Max and min. speed page 6 - type 1			Max and min. speed page 6 - type 2		

<p>Fixed only by threaded head</p>					
MK V11D17	PC 0,5 mm OC 5,5 mm CD 0,05 mm CAP 2,2 mm	FS 4 N FR 3 N FAP 20 N	MK V11D30	PC 9 mm OC 10 mm CD 1,1 mm	FS 0,65 N FR 0,5 N
Max and min. speed page 6 - type 2			Max and min. speed page 6 - type 3		

MK V11D32	PC 7,7 mm OC 8,3 mm CD 0,9 mm	FS 0,76 N FR 0,58 N	MK V11D35	PC 19 mm OC 16,7 mm CD 2,5 mm	FS 0,28 N FR 0,22 N
Max and min. speed page 6 - type 3			Max and min. speed page 6 - type 3		

Microswitches MK series

	MK V11D37 1NO+1NC PC 19 mm FS 0,08 N OC 9,5 mm FR 0,04 N CD 2,3 mm		MK V11D40 1NO+1NC PC 6,7 mm FS 0,86 N OC 7,8 mm FR 0,66 N CD 0,8 mm
Max and min. speed page 6 - type 3		Max and min. speed page 6 - type 6	
	MK V11D42 1NO+1NC PC 5,3 mm FS 1,09 N OC 5,7 mm FR 0,84 N CD 0,6 mm		MK V11D45 1NO+1NC PC 3,5 mm FS 1,66 N OC 4,5 mm FR 1,28 N CD 0,4 mm
Max and min. speed page 6 - type 6		Max and min. speed page 6 - type 6	
	MK V11D47 1NO+1NC PC 3,5 mm FS 1,66 N OC 4 mm FR 1,28 N CD 0,4 mm		MK V11D49 1NO+1NC Hand operated
Max and min. speed page 6 - type 6		Max and min. speed page 6 - type 3	
	MK V11D53 1NO+1NC PC 7,7 mm FS 0,76 N OC 8,9 mm FR 0,58 N CD 0,9 mm		MK V11D59 1NO+1NC PC 2,5 mm FS 2,3 N OC 4,5 mm FR 1,77 N CD 0,2 mm
Max and min. speed page 6 - type 6		Max and min. speed page 6 - type 6	

Items with code on the **green** background are available in stock

Microswitches with inverted action (All measures in the drawings are in mm)

10 pcs packs

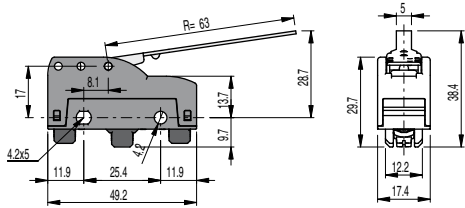

MK V11R30	1NO+1NC	PC 9 mm OC 15 mm CD 0,5 mm	FS 0,59 N FR 0,56 N
------------------	---------	----------------------------------	------------------------

Max and min. speed page 6 - type 4

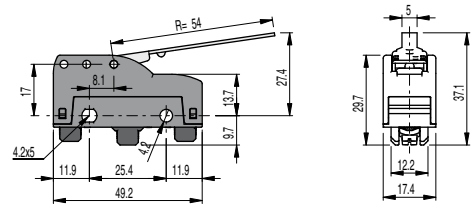

MK V11R32	1NO+1NC	PC 7,7 mm OC 11,6 mm CD 0,4 mm	FS 0,68 N FR 0,66 N
------------------	---------	--------------------------------------	------------------------

Max and min. speed page 6 - type 4

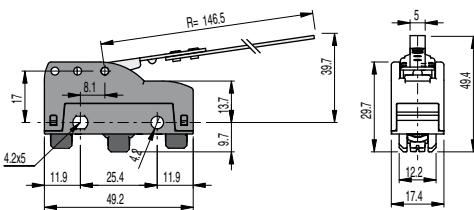

MK V11R35	1NO+1NC	PC 20 mm OC 23 mm CD 1,2 mm	FS 0,25 N FR 0,24 N
------------------	---------	-----------------------------------	------------------------

Max and min. speed page 6 - type 4

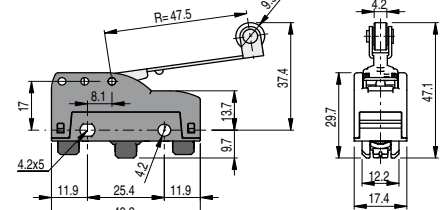

MK V11R40	1NO+1NC	PC 6,7 mm OC 10,3 mm CD 0,4 mm	FS 0,77 N FR 0,75 N
------------------	---------	--------------------------------------	------------------------

Max and min. speed page 6 - type 7

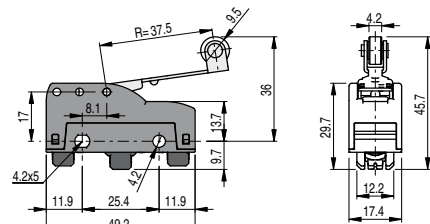

MK V11R42	1NO+1NC	PC 5,3 mm OC 8 mm CD 0,3 mm	FS 0,98 N FR 0,95 N
------------------	---------	-----------------------------------	------------------------

Max and min. speed page 6 - type 7

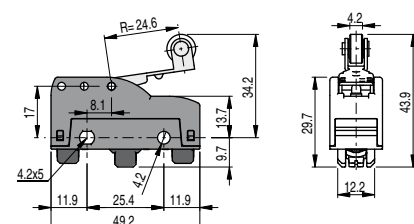

MK V11R45	1NO+1NC	PC 3,5 mm OC 5,4 mm CD 0,2 mm	FS 1,5 N FR 1,45 N
------------------	---------	-------------------------------------	-----------------------

Max and min. speed page 6 - type 7

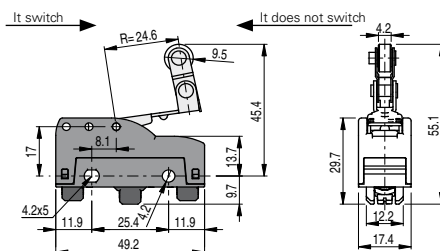

MK V11R47	1NO+1NC	PC 3,5 mm OC 4,9 mm CD 0,2 mm	FS 1,5 N FR 1,45 N
------------------	---------	-------------------------------------	-----------------------

Max and min. speed page 6 - type 7

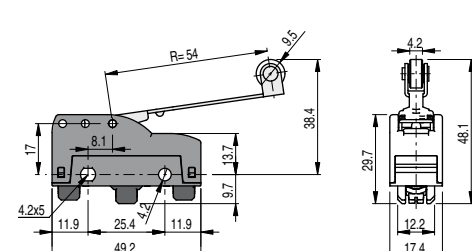

MK V11R53	1NO+1NC	PC 7,7 mm OC 11,7 mm CD 0,5 mm	FS 0,68 N FR 0,66 N
------------------	---------	--------------------------------------	------------------------

Max and min. speed page 6 - type 7

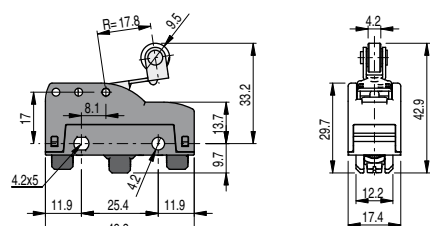

MK V11R59	1NO+1NC	PC 2,5 mm OC 3,9 mm CD 0,2 mm	FS 2,07 N FR 2 N
------------------	---------	-------------------------------------	---------------------

Max and min. speed page 6 - type 7

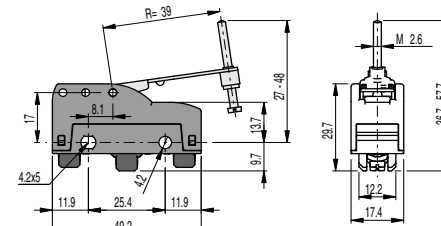

MK V11R60	1NO+1NC	PC 6 mm OC 8,5 mm CD 0,3 mm	FS 0,94 N FR 0,91 N
------------------	---------	-----------------------------------	------------------------

Max and min. speed page 6 - type 4

Microswitches with back direct action (All measures in the drawings are in mm)

10 pcs packs

MK V11F30 1NO+1NC PC 2,7 mm FS 0,6 N OC 12,9 mm FR 0,5 N CD 0,35 mm	MK V11F32 1NO+1NC PC 2,5 mm FS 0,7 N OC 11,5 mm FR 0,6 N CD 0,3 mm
Max and min. speed page 6 - type 5	Max and min. speed page 6 - type 5

MK V11F35 1NO+1NC PC 7,5 mm FS 0,25 N OC 25,9 mm FR 0,2 N CD 1,3 mm	MK V11F40 1NO+1NC PC 2,4 mm FS 0,85 N OC 10,4 mm FR 0,65 N CD 0,25 mm
Max and min. speed page 6 - type 5	Max and min. speed page 6 - type 8

MK V11F42 1NO+1NC PC 1,6 mm FS 1 N OC 8,4 mm FR 0,7 N CD 0,2 mm FAP 4,9 N CAP 9 mm	MK V11F45 1NO+1NC PC 1,1 mm FS 1,3 N OC 6,6 mm FR 0,9 N CD 0,1 mm FAP 6,9 N CAP 6,3 mm
Max and min. speed page 6 - type 8	Max and min. speed page 6 - type 8

MK V11F47 1NO+1NC PC 1,1 mm FS 1,3 N OC 5,6 mm FR 0,9 N CD 0,1 mm FAP 6,9 N CAP 6,3 mm	MK V11F49 1NO+1NC PC 1,5 mm FS 1 N OC 7,5 mm FR 0,7 N CD 0,2 mm FAP 4,8 N CAP 9 mm
Max and min. speed page 6 - type 8	Max and min. speed page 6 - type 5

MK V11F53 1NO+1NC PC 2,5 mm FS 0,7 N OC 11,5 mm FR 0,6 N CD 0,3 mm	MK V11F59 1NO+1NC PC 0,8 mm FS 1,7 N OC 5,2 mm FR 1,3 N CD 0,08 mm FAP 8,9 N CAP 4,9 mm
Max and min. speed page 6 - type 8	Max and min. speed page 6 - type 8

Items with code on the green background are available in stock

Protections (terminals covers)

10 pcs packs

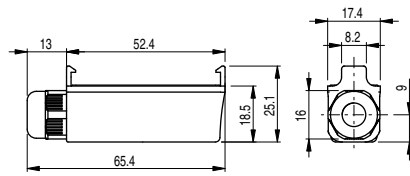

Protection terminal cover for screw terminals snap-in assembled and with wire trap cable gland. It allows the installation of more switches side by side.

Article	Description	Protection degree
VF MKCV11	Protection terminal cover without gasket for multipolar cables from Ø 5 to Ø 7,5 mm	IP40
VF MKCV12	Protection terminal cover without gasket for multipolar cables from Ø 4 to Ø 7,5 mm	IP40
VF MKCV13	Protection terminal cover without gasket for multipolar cables from Ø 2 to Ø 5 mm	IP40
VF MKCV22	Protection terminal cover with gasket for multipolar cables from Ø 4 to Ø 7,5 mm	IP65
VF MKCV23	Protection terminal cover with gasket for multipolar cables from Ø 2 to Ø 5 mm	IP65

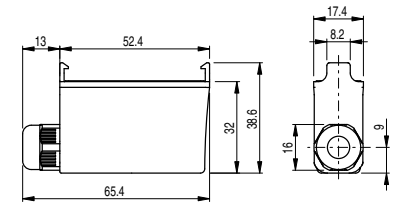

Protection terminal cover for vertical faston terminals snap-in assembled and with wire trap cable gland. It allows the installation of more switches side by side.

Article	Description	Protection degree
VF MKCH11	Protection terminal cover without gasket for multipolar cables from Ø 5 to Ø 7,5 mm	IP40
VF MKCH12	Protection terminal cover without gasket for multipolar cables from Ø 4 to Ø 7,5 mm	IP40
VF MKCH13	Protection terminal cover without gasket for multipolar cables from Ø 2 to Ø 5 mm	IP40
VF MKCH22	Protection terminal cover with gasket for multipolar cables from Ø 4 to Ø 7,5 mm	IP65
VF MKCH23	Protection terminal cover with gasket for multipolar cables from Ø 2 to Ø 5 mm	IP65

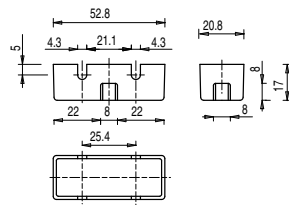

Article	Description	Protection degree
VF C01	Protection terminal cover for screw terminals	IP20

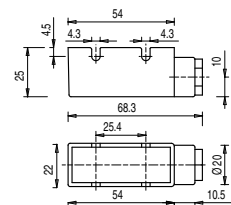

Article	Description	Protection degree
VF C02	Protection terminal cover for screw terminals with cable gland PG9 for multipolar cables from Ø 5 to Ø 7 mm	IP40

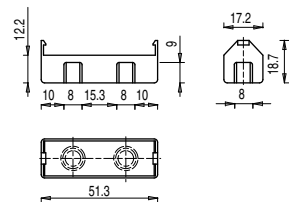

Article	Description	Protection degree
VF C03	Protection terminal cover for screw terminals snap-in assembled. It allows the installation of more switches side by side	IP20

Accessories

10 pcs packs

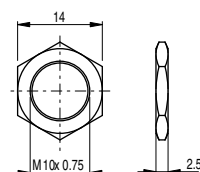

Article	Description
VF AC83	Hexagonal threaded nut M10 x 0,75 for microswitches

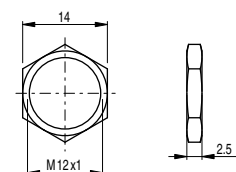

Article	Description
VF AC72	Hexagonal threaded nut M12 x 1 for microswitches

Items with code on the green background are available in stock

Cross-reference

old articles	new articles	old articles	new articles	old articles	new articles
MF 01	MK H11D01	MM 54	MK V11R40	MV 45	MK V11D45
MF 02	MK H11D02	MM 55	MK V11R42	MV 47	MK V11D47
MF 03	MK H11D03	MM 57	MK V11R47	MV 49	MK V11D49
MF 04	MK H11D04	MM 58	MK V11R45	MV 50	MK V11R32
MF 05	MK H11D05	MM 59	MK V11R59	MV 52	MK V11R30
MF 06	MK H11D06	MM 60	MK V11R60	MV 53	MK V11R53
MF 08	MK H11D08	MS 01	MK V11D01	MV 54	MK V11R40
MF 09	MK H11D09	MS 02	MK V11D02	MV 55	MK V11R42
MF 10	MK H11D10	MS 03	MK V11D03	MV 57	MK V11R47
MF 12	MK H11D12	MS 04	MK V11D04	MV 58	MK V11R45
MF 13	MK H11D13	MS 05	MK V11D05	MV 59	MK V11R59
MF 15	MK H11D15	MS 06	MK V11D06	MV 60	MK V11R60
MF 17	MK H11D17	MS 08	MK V11D08		
MF 20	MK H11D15	MS 09	MK V11D09		
MF 30	MK H11D30	MS 10	MK V11D10		
MF 32	MK H11D32	MS 12	MK V11D12		
MF 35	MK H11D35	MS 13	MK V11D13		
MF 37	MK H11D37	MS 15	MK V11D15		
MF 40	MK H11D40	MS 17	MK V11D17		
MF 42	MK H11D42	MS 20	MK V11D15		
MF 45	MK H11D45	MS 30	MK V11D30		
MF 47	MK H11D47	MS 32	MK V11D32		
MF 49	MK H11D49	MS 35	MK V11D35		
MF 50	MK H11R32	MS 37	MK V11D37		
MF 52	MK H11R30	MS 40	MK V11D40		
MF 53	MK H11R53	MS 42	MK V11D42		
MF 54	MK H11R40	MS 45	MK V11D45		
MF 55	MK H11R42	MS 47	MK V11D47		
MF 57	MK H11R47	MS 49	MK V11D49		
MF 58	MK H11R45	MS 50	MK V11R32		
MF 59	MK H11R59	MS 52	MK V11R30		
MF 60	MK H11R60	MS 53	MK V11R53		
MM 01	MK V11D01	MS 54	MK V11R40		
MM 02	MK V11D02	MS 55	MK V11R42		
MM 03	MK V11D03	MS 57	MK V11R47		
MM 04	MK V11D04	MS 58	MK V11R45		
MM 05	MK V11D05	MS 59	MK V11R59		
MM 06	MK V11D06	MS 60	MK V11R60		
MM 08	MK V11D08	MV 01	MK V11D01		
MM 09	MK V11D09	MV 02	MK V11D02		
MM 10	MK V11D10	MV 03	MK V11D03		
MM 12	MK V11D12	MV 04	MK V11D04		
MM 13	MK V11D13	MV 05	MK V11D05		
MM 15	MK V11D15	MV 06	MK V11D06		
MM 17	MK V11D17	MV 08	MK V11D08		
MM 20	MK V11D15	MV 09	MK V11D09		
MM 30	MK V11D30	MV 10	MK V11D10		
MM 32	MK V11D32	MV 12	MK V11D12		
MM 35	MK V11D35	MV 13	MK V11D13		
MM 37	MK V11D37	MV 15	MK V11D15		
MM 40	MK V11D40	MV 17	MK V11D17		
MM 42	MK V11D42	MV 20	MK V11D15		
MM 45	MK V11D45	MV 30	MK V11D30		
MM 47	MK V11D47	MV 32	MK V11D32		
MM 49	MK V11D49	MV 35	MK V11D35		
MM 50	MK V11R32	MV 37	MK V11D37		
MM 52	MK V11R30	MV 40	MK V11D40		
MM 53	MK V11R53	MV 42	MK V11D42		

Production

Pizzato Elettrica's products range offers more than 6000 standard articles and 1000 special items created on specific requirements of the customer.

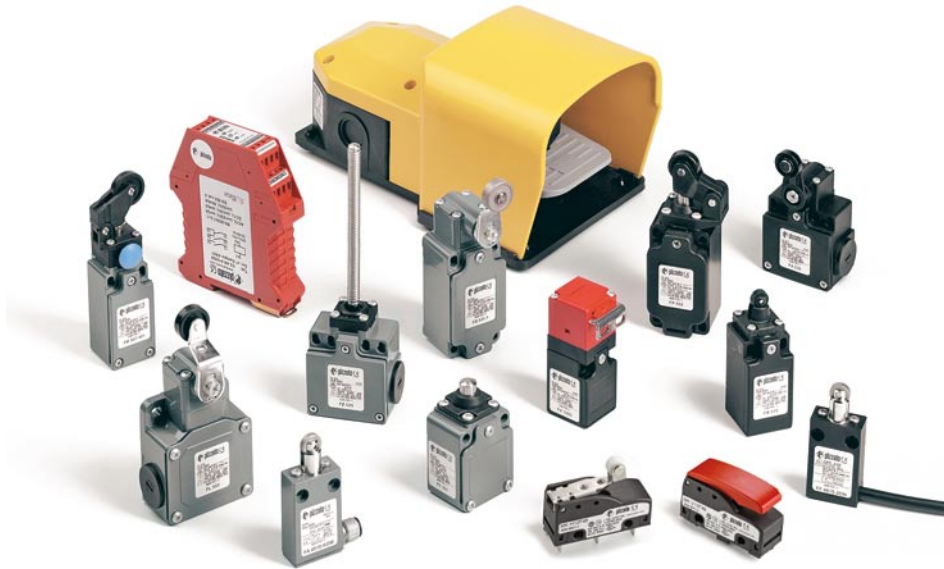

Documentation

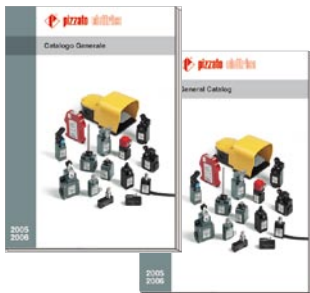

General Catalog 18

available languages:



Production Program

available languages:



CD-ROM

available languages:



www.pizzato.it
www.pizzato.com

- general catalog on line PDF format
- search engine for product code
- download 2D CAD drawings in DXF format
- download documentations

Any information or application example, included the connection diagrams, described in this document are to be intended as purely descriptive. The choice and application of the products in conformity with the Standards, in order to avoid damages to persons or goods, is under the responsibility of the user.

The drawings and data contained in this catalog are not binding, and we reserve the right to improve the quality of our products to modify them at any time without prior notification.

This publication cannot be copied in whole or in part without prior permission from the publisher.

All rights reserved. © 2007 Copyright Pizzato Elettrica

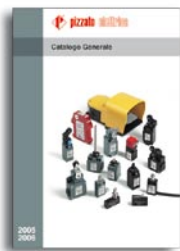

General catalog
2005/2006



Production program



ATEX brochure

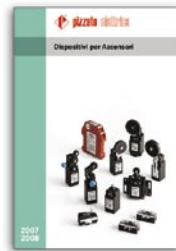

Lift devices
brochure



Cd-rom
2006



Web site
www.pizzato.com



Pizzato Elettrica s.r.l. Via Torino, 1 - 36063 Marostica (VI) Italy
Phone +39.0424.470.930 - Fax +39.0424.470.955
E-mail: info@pizzato.com - Web site: www.pizzato.com

X-ON Electronics

Largest Supplier of Electrical and Electronic Components

Click to view similar products for [Basic / Snap Action Switches](#) category:

Click to view products by [Pizzato](#) manufacturer:

Other Similar products are found below :

[83228001](#) [01.098.1358.1](#) [602EN1-6B](#) [602EN532](#) [602EN535-RB](#) [602HE5-RB1](#) [604HE162](#) [604HE223-6B](#) [624HE17-RB](#) [6HM89](#) [6PA78-JM](#)
[6SE1](#) [6SX1-H58](#) [70500840](#) [MBD5B1](#) [MBH2731](#) [73-316-0012](#) [79211759](#) [79211923](#) [79218589](#) [7AS12](#) [ML-1155](#) [ML-1376](#) [831010C3.0](#)
[831060C3.TL](#) [831090C2.EL](#) [83131904](#) [84212012](#) [8AS239](#) [8HM73-3](#) [903VB1-PG](#) [914CE1-6G](#) [PL-100](#) [11SM1077-H4](#) [11SM1077-H58](#)
[11SM1-TN107](#) [11SM405](#) [11SM703-T](#) [11SM8423-H2](#) [11SX37-T](#) [11SX48-H58](#) [11SX55-H58](#) [11SM2442-T](#) [11SM76-T](#) [11SM77-H58](#)
[11SM77-T](#) [11SM863-T](#) [11SM866](#) [11SX47-H58](#) [A7CN-1M-1-LEFT](#)