



Integrated Device Technology, Inc.

FAST CMOS OCTAL BIDIRECTIONAL TRANSCEIVERS

IDT54/74FCT245T/AT/CT/DT - 2245T/AT/CT
IDT54/74FCT640T/AT/CT
IDT54/74FCT645T/AT/CT/DT

FEATURES:

- **Common features:**
 - Low input and output leakage $\leq 1\mu\text{A}$ (max.)
 - CMOS power levels
 - True TTL input and output compatibility
 - $V_{OH} = 3.3\text{V}$ (typ.)
 - $V_{OL} = 0.3\text{V}$ (typ.)
 - Meets or exceeds JEDEC standard 18 specifications
 - Product available in Radiation Tolerant and Radiation Enhanced versions
 - Military product compliant to MIL-STD-883, Class B and DESC listed (dual marked)
 - Available in DIP, SOIC, SSOP, QSOP, CERPACK and LCC packages
- **Features for FCT245T/FCT640T/FCT645T:**
 - Std., A, C and D speed grades
 - High drive outputs (-15mA IOH, 64mA IOL)
- **Features for FCT2245T:**
 - Std., A and C speed grades
 - Resistor outputs (-15mA IOH, 12mA IOL Com.) (-12mA IOH, 12mA IOL Mil.)
 - Reduced system switching noise

DESCRIPTION:

The IDT octal bidirectional transceivers are built using an advanced dual metal CMOS technology. The FCT245T/FCT2245T, FCT640T and FCT645T are designed for asynchronous two-way communication between data buses. The transmit/receive (T/R) input determines the direction of data flow through the bidirectional transceiver. Transmit (active HIGH) enables data from A ports to B ports, and receive (active LOW) from B ports to A ports. The output enable (OE) input, when HIGH, disables both A and B ports by placing them in HIGH Z condition.

The FCT245T/FCT2245T and FCT645T transceivers have non-inverting outputs. The FCT640T has inverting outputs.

The FCT2245T has balanced drive outputs with current limiting resistors. This offers low ground bounce, minimal undershoot and controlled output fall times- reducing the need for external series terminating resistors. The FCT2xxxT parts are plug-in replacements for FCTxxxT parts.

FUNCTIONAL BLOCK DIAGRAM

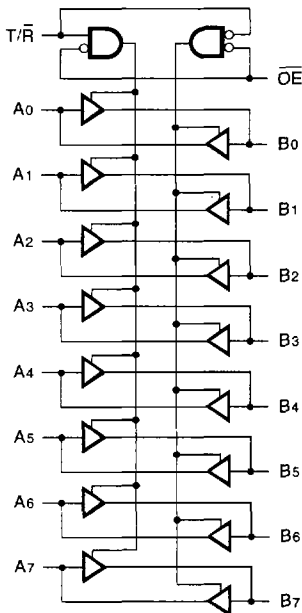

FCT245T/2245T, FCT645T are non-inverting options.
FCT640T is the inverting options.

2539 drw 01

PIN CONFIGURATIONS

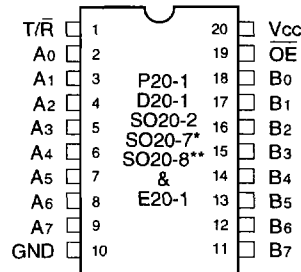

DIP/SOIC/SSOP/QSOP/CERPACK
TOP VIEW

2539 drw 02

*FCT245T/2245T, FCT645T only.
**FCT245T/2245T, FCT640T

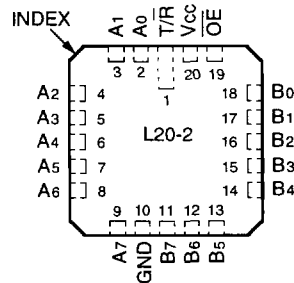

LCC
TOP VIEW

2539 drw 03

The IDT logo is a registered trademark of Integrated Device Technology, Inc.

MILITARY AND COMMERCIAL TEMPERATURE RANGES

JUNE 1996

PIN DESCRIPTION

Pin Names	Description
\overline{OE}	Output Enable Input (Active LOW)
T/\overline{R}	Transmit/Receive Input
A0-A7	Side A Inputs or 3-State Outputs
B0-B7	Side B Inputs or 3-State Outputs

2539 tbl 01

FUNCTION TABLE⁽²⁾

Inputs		Outputs
\overline{OE}	T/\overline{R}	
L	L	Bus B Data to Bus A ⁽¹⁾
L	H	Bus B Data to Bus B ⁽¹⁾
H	X	High Z State

2539 tbl 02

NOTES:

- 640 is inverting from input to output.
- H = HIGH Voltage Level
 L = LOW Voltage Level
 X = Don't Care

ABSOLUTE MAXIMUM RATINGS⁽¹⁾

Symbol	Rating	Commercial	Military	Unit
$V_{TERM}^{(2)}$	Terminal Voltage with Respect to GND	-0.5 to +7.0	-0.5 to +7.0	V
$V_{TERM}^{(3)}$	Terminal Voltage with Respect to GND	-0.5 to $V_{CC}+0.5$	-0.5 to $V_{CC}+0.5$	V
T_A	Operating Temperature	0 to +70	-55 to +125	°C
T_{BIAS}	Temperature Under Bias	-55 to +125	-65 to +135	°C
T_{STG}	Storage Temperature	-55 to +125	-65 to +150	°C
P_T	Power Dissipation	0.5	0.5	W
I_{OUT}	DC Output Current	-60 to +120	-60 to +120	mA

2539 lmk 03

NOTES:

- Stresses greater than those listed under ABSOLUTE MAXIMUM RATINGS may cause permanent damage to the device. This is a stress rating only and functional operation of the device at these or any other conditions above those indicated in the operational sections of this specification is *not implied*. Exposure to absolute maximum rating conditions for extended periods may affect reliability. No terminal voltage may exceed V_{CC} by +0.5V unless otherwise noted.
- Input and V_{CC} terminals only.
- Outputs and I/O terminals only.

CAPACITANCE ($T_A = +25^\circ\text{C}$, $F = 1.0\text{MHz}$)

Symbol	Parameter ⁽¹⁾	Conditions	Typ.	Max.	Unit
C_{IN}	Input Capacitance	$V_{IN} = 0V$	6	10	pF
C_{OUT}	Output Capacitance	$V_{OUT} = 0V$	8	12	pF

2539 lmk 04

NOTE:

- This parameter is measured at characterization but not tested.

DC ELECTRICAL CHARACTERISTICS OVER OPERATING RANGE

Following Conditions Apply Unless Otherwise Specified:

Commercial: TA = 0°C to +70°C, VCC = 5.0V ± 5%; Military: TA = -55°C to +125°C, VCC = 5.0V ± 10%

Symbol	Parameter	Test Conditions ⁽¹⁾	Min.	Typ. ⁽²⁾	Max.	Unit
V _{IH}	Input HIGH Level	Guaranteed Logic HIGH Level	2.0	—	—	V
V _{IL}	Input LOW Level	Guaranteed Logic LOW Level	—	—	0.8	V
I _{IH}	Input HIGH Current ⁽⁴⁾	VCC = Max. V _I = 2.7V	—	—	±1	μA
I _{IL}	Input LOW Current ⁽⁴⁾		V _I = 0.5V	—	—	
I _{OZH}	High Impedance Output Current (3-State Output pins) ⁽⁴⁾	VCC = Max. V _O = 2.7V	—	—	±1	μA
I _{OZL}			V _O = 0.5V	—	—	
I _I	Input HIGH Current ⁽⁴⁾	VCC = Max., V _I = VCC (Max.)	—	—	±1	μA
V _{IK}	Clamp Diode Voltage	VCC = Min., I _{IN} = -18mA	—	-0.7	-1.2	V
V _H	Input Hysteresis	—	—	200	—	mV
I _{CC}	Quiescent Power Supply Current	VCC = Max., V _{IN} = GND or VCC	—	0.01	1	mA

2539 Ink 05

OUTPUT DRIVE CHARACTERISTICS FOR FCT245T/640T/645T

Symbol	Parameter	Test Conditions ⁽¹⁾	Min.	Typ. ⁽²⁾	Max.	Unit	
V _{OH}	Output HIGH Voltage	VCC = Min. V _{IN} = V _{IH} or V _{IL}	I _{OH} = -6mA MIL.	2.4	3.3	—	V
			I _{OH} = -8mA COM'L.	2.0	3.0	—	V
			I _{OH} = -12mA MIL. I _{OH} = -15mA COM'L.				
V _{OL}	Output LOW Voltage	VCC = Min. V _{IN} = V _{IH} or V _{IL}	—	0.3	0.55	V	
I _{OS}	Short Circuit Current	VCC = Max., V _O = GND ⁽³⁾	-60	-120	-225	mA	

2539 Ink 06

OUTPUT DRIVE CHARACTERISTICS FOR FCT2245T

Symbol	Parameter	Test Conditions ⁽¹⁾	Min.	Typ. ⁽²⁾	Max.	Unit	
I _{ODL}	Output LOW Current	VCC = 5V, V _{IN} = V _{IH} or V _{IL} , V _{OUT} = 1.5V ⁽³⁾	16	48	—	mA	
I _{ODH}	Output HIGH Current	VCC = 5V, V _{IN} = V _{IH} or V _{IL} , V _{OUT} = 1.5V ⁽³⁾	-16	-48	—	mA	
V _{OH}	Output HIGH Voltage	VCC = Min. V _{IN} = V _{IH} or V _{IL}	I _{OH} = -12mA MIL.	2.4	3.3	—	V
			I _{OH} = -15mA COM'L.				
V _{OL}	Output LOW Voltage	VCC = Min. V _{IN} = V _{IH} or V _{IL}	—	0.3	0.50	V	

2539 Ink 07

NOTES:

- For conditions shown as Max. or Min., use appropriate value specified under Electrical Characteristics for the applicable device type.
- Typical values are at VCC = 5.0V, +25°C ambient.
- Not more than one output should be shorted at one time. Duration of the short circuit test should not exceed one second.
- The test limit for this parameter is ±5μA at TA = -55°C.

6

POWER SUPPLY CHARACTERISTICS

Symbol	Parameter	Test Conditions ⁽¹⁾			Min.	Typ. ⁽²⁾	Max.	Unit
ΔI_{CC}	Quiescent Power Supply Current TTL Inputs HIGH	V _{CC} = Max. V _{IN} = 3.4V ⁽³⁾			—	0.5	2.0	mA
I _{CCD}	Dynamic Power Supply Current ⁽⁴⁾	V _{CC} = Max. Outputs Open $\overline{OE} = T/\overline{R} = GND$ One Input Toggling 50% Duty Cycle	V _{IN} = V _{CC} V _{IN} = GND	FCTxxxT FCT2xxxT	— —	0.15 0.06	0.25 0.12	mA/ MHz
I _C	Total Power Supply Current ⁽⁶⁾	V _{CC} = Max. Outputs Open f _i = 10MHz 50% Duty Cycle $\overline{OE} = T/\overline{R} = GND$ One Bit Toggling	V _{IN} = V _{CC} V _{IN} = GND V _{IN} = 3.4 V _{IN} = GND	FCTxxxT FCT2xxxT FCTxxxT FCT2xxxT	— — — —	1.5 0.6 1.8 0.9	3.5 2.2 4.5 3.2	mA
		V _{CC} = Max. Outputs Open f _i = 2.5MHz 50% Duty Cycle $\overline{OE} = T/\overline{R} = GND$ Eight Bits Toggling	V _{IN} = V _{CC} V _{IN} = GND V _{IN} = 3.4 V _{IN} = GND	FCTxxxT FCT2xxxT FCTxxxT FCT2xxxT	— — — —	3.0 1.2 5.0 3.2	6.0 ⁽⁵⁾ 3.4 ⁽⁵⁾ 14.0 ⁽⁵⁾ 11.4 ⁽⁵⁾	

2539 tbl 08

NOTES:

- For conditions shown as Max. or Min., use appropriate value specified under Electrical Characteristics for the applicable device type.
- Typical values are at V_{CC} = 5.0V, +25°C ambient.
- Per TTL driven input (V_{IN} = 3.4V). All other inputs at V_{CC} or GND.
- This parameter is not directly testable, but is derived for use in Total Power Supply Calculations.
- Values for these conditions are examples of the I_{CC} formula. These limits are guaranteed but not tested.
- I_C = I_{QUIESCENT} + I_{INPUTS} + I_{DYNAMIC}
 $I_C = I_{CC} + \Delta I_{CC} D_H N_T + I_{CCD} (f_{CP}/2 + f_i N_i)$
 I_{CC} = Quiescent Current
 ΔI_{CC} = Power Supply Current for a TTL High Input (V_{IN} = 3.4V)
 D_H = Duty Cycle for TTL Inputs High
 N_T = Number of TTL Inputs at D_H
 I_{CCD} = Dynamic Current Caused by an Input Transition Pair (HLH or LHL)
 f_{CP} = Clock Frequency for Register Devices (Zero for Non-Register Devices)
 f_i = Input Frequency
 N_i = Number of Inputs at f_i
 All currents are in milliamps and all frequencies are in megahertz.

SWITCHING CHARACTERISTICS OVER OPERATING RANGE

Symbol	Parameter	Conditions ⁽¹⁾	FCT245T FCT2245T				FCT245AT FCT2245AT				Unit
			Com'l.		Mil.		Com'l.		Mil.		
			Min. ⁽²⁾	Max.	Min. ⁽²⁾	Max.	Min. ⁽²⁾	Max.	Min. ⁽²⁾	Max.	
tPLH tPHL	Propagation Delay A to B, B to A	CL = 50 pF RL = 500Ω	1.5	7.0	1.5	7.5	1.5	4.6	1.5	4.9	ns
tpZH tpZL	Output Enable Time OE to A or B		1.5	9.5	1.5	10.0	1.5	6.2	1.5	6.5	ns
tpHZ tPLZ	Output Disable Time OE to A or B		1.5	7.5	1.5	10.0	1.5	5.0	1.5	6.0	ns
tpZH tpZL	Output Enable Time T/R to A or B ⁽³⁾		1.5	9.5	1.5	10.0	1.5	6.2	1.5	6.5	ns
tpHZ tPLZ	Output Disable Time T/R to A or B ⁽³⁾		1.5	7.5	1.5	10.0	1.5	5.0	1.5	6.0	ns

2534 tbi 09

Symbol	Parameter	Conditions ⁽¹⁾	FCT245CT FCT2245CT				FCT245DT				Unit
			Com'l.		Mil.		Com'l.		Mil.		
			Min. ⁽²⁾	Max.	Min. ⁽²⁾	Max.	Min. ⁽²⁾	Max.	Min. ⁽²⁾	Max.	
tPLH tPHL	Propagation Delay A to B, B to A	CL = 50 pF RL = 500Ω	1.5	4.1	1.5	4.5	1.5	3.8	—	—	ns
tpZH tpZL	Output Enable Time OE to A or B		1.5	5.8	1.5	6.2	1.5	5.0	—	—	ns
tpHZ tPLZ	Output Disable Time OE to A or B		1.5	4.8	1.5	5.2	1.5	4.3	—	—	ns
tpZH tpZL	Output Enable Time T/R to A or B ⁽³⁾		1.5	5.8	1.5	6.2	1.5	5.0	—	—	ns
tpHZ tPLZ	Output Disable Time T/R to A or B ⁽³⁾		1.5	4.8	1.5	5.2	1.5	4.3	—	—	ns

2534 tbi 10

6

SWITCHING CHARACTERISTICS OVER OPERATING RANGE

Symbol	Parameter	Conditions ⁽¹⁾	FCT640T				FCT640AT				FCT640CT				Unit
			Com'l.		Mil.		Com'l.		Mil.		Com'l.		Mil.		
			Min. ⁽²⁾	Max.	Min. ⁽²⁾	Max.	Min. ⁽²⁾	Max.	Min. ⁽²⁾	Max.	Min. ⁽²⁾	Max.	Min. ⁽²⁾	Max.	
tPLH tPHL	Propagation Delay A to B, B to A	CL = 50 pF RL = 500Ω	2.0	7.0	2.0	8.0	1.5	5.0	1.5	5.3	1.5	4.4	1.5	4.7	ns
tpZH tpZL	Output Enable Time OE to A or B		2.0	13.0	2.0	16.0	1.5	6.2	1.5	6.5	1.5	5.8	1.5	6.2	ns
tpHZ tPLZ	Output Disable Time OE to A or B		2.0	10.0	2.0	12.0	1.5	5.0	1.5	6.0	1.5	4.8	1.5	5.2	ns
tpZH tpZL	Output Enable Time T/R to A or B ⁽³⁾		2.0	13.0	2.0	16.0	1.5	6.2	1.5	6.5	1.5	5.8	1.5	6.2	ns
tpHZ tPLZ	Output Disable Time T/R to A or B ⁽³⁾		2.0	10.0	2.0	12.0	1.5	5.0	1.5	6.0	1.5	4.8	1.5	5.2	ns

NOTES:

2534 tbi 11

1. See test circuit and waveforms.
2. Minimum limits are guaranteed but not tested on Propagation Delays.
3. This parameter is guaranteed but not tested.

SWITCHING CHARACTERISTICS OVER OPERATING RANGE

Symbol	Parameter	Conditions ⁽¹⁾	FCT645T				FCT645AT				Unit
			Com'l.		Mil.		Com'l.		Mil.		
			Min. ⁽²⁾	Max.	Min. ⁽²⁾	Max.	Min. ⁽²⁾	Max.	Min. ⁽²⁾	Max.	
tPLH	Propagation Delay	CL = 50 pF RL = 500Ω	1.5	9.5	1.5	11.0	1.5	4.6	1.5	4.9	ns
tPHL	A to B, B to A										
tPZH	Output Enable Time		1.5	11.0	1.5	12.0	1.5	6.2	1.5	6.5	ns
tPZL	\overline{OE} to A or B										
tPHZ	Output Disable Time		1.5	12.0	1.5	13.0	1.5	5.0	1.5	6.0	ns
tPLZ	\overline{OE} to A or B										
tPZH	Output Enable Time	T/ \overline{R} to A or B ⁽³⁾	1.5	11.0	1.5	12.0	1.5	6.2	1.5	6.5	ns
tPZL	T/ \overline{R} to A or B ⁽³⁾										
tPHZ	Output Disable Time	T/ \overline{R} to A or B ⁽³⁾	1.5	12.0	1.5	13.0	1.5	5.0	1.5	6.0	ns
tPLZ	T/ \overline{R} to A or B ⁽³⁾										

2534 tbl 12

Symbol	Parameter	Conditions ⁽¹⁾	FCT645CT				FCT645DT				Unit
			Com'l.		Mil.		Com'l.		Mil.		
			Min. ⁽²⁾	Max.	Min. ⁽²⁾	Max.	Min. ⁽²⁾	Max.	Min. ⁽²⁾	Max.	
tPLH	Propagation Delay	CL = 50 pF RL = 500Ω	1.5	4.1	1.5	4.5	1.5	3.8	—	—	ns
tPHL	A to B, B to A										
tPZH	Output Enable Time		1.5	5.8	1.5	6.2	1.5	5.0	—	—	ns
tPZL	\overline{OE} to A or B										
tPHZ	Output Disable Time		1.5	4.8	1.5	5.2	1.5	4.3	—	—	ns
tPLZ	\overline{OE} to A or B										
tPZH	Output Enable Time	T/ \overline{R} to A or B ⁽³⁾	1.5	5.8	1.5	6.2	1.5	5.0	—	—	ns
tPZL	T/ \overline{R} to A or B ⁽³⁾										
tPHZ	Output Disable Time	T/ \overline{R} to A or B ⁽³⁾	1.5	4.8	1.5	5.2	1.5	4.3	—	—	ns
tPLZ	T/ \overline{R} to A or B ⁽³⁾										

2534 tbl 13

NOTES:

1. See test circuit and waveforms.
2. Minimum limits are guaranteed but not tested on Propagation Delays.
3. This parameter is guaranteed but not tested.

TEST CIRCUITS AND WAVEFORMS

TEST CIRCUITS FOR ALL OUTPUTS

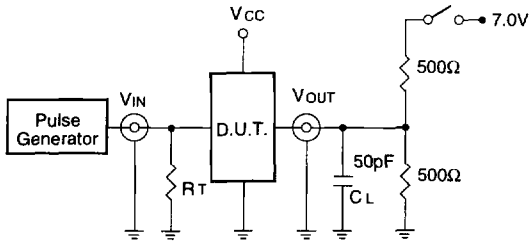

2534 drw 04

SWITCH POSITION

Test	Switch
Open Drain Disable Low Enable Low	Closed
All Other Tests	Open

DEFINITIONS:

C_L = Load capacitance: includes jig and probe capacitance.
 R_T = Termination resistance: should be equal to Z_{out} of the Pulse Generator.

2534 Irk 14

SET-UP, HOLD AND RELEASE TIMES

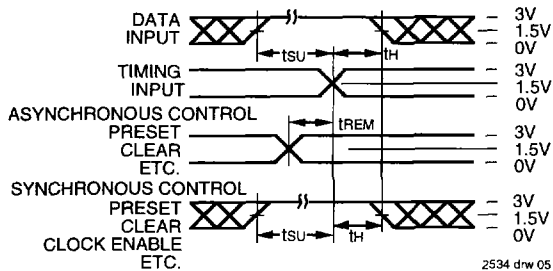

2534 drw 05

PULSE WIDTH

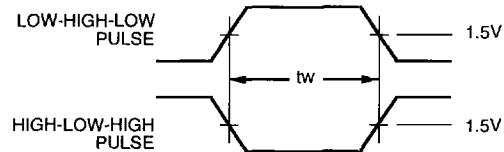

2534 drw 06

PROPAGATION DELAY

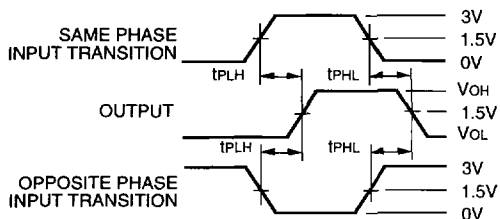

2534 drw 07

ENABLE AND DISABLE TIMES

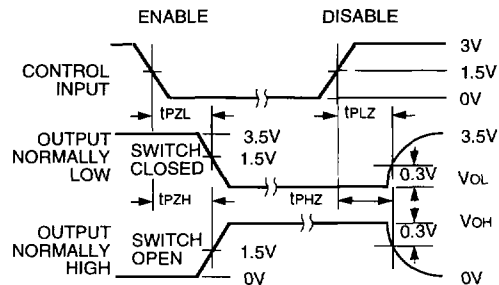

2534 drw 08

NOTES:

- Diagram shown for input Control Enable-LOW and input Control Disable-HIGH
- Pulse Generator for All Pulses: Rate $\leq 1.0\text{MHz}$; $t_r \leq 2.5\text{ns}$; $t_s \leq 2.5\text{ns}$

ORDERING INFORMATION

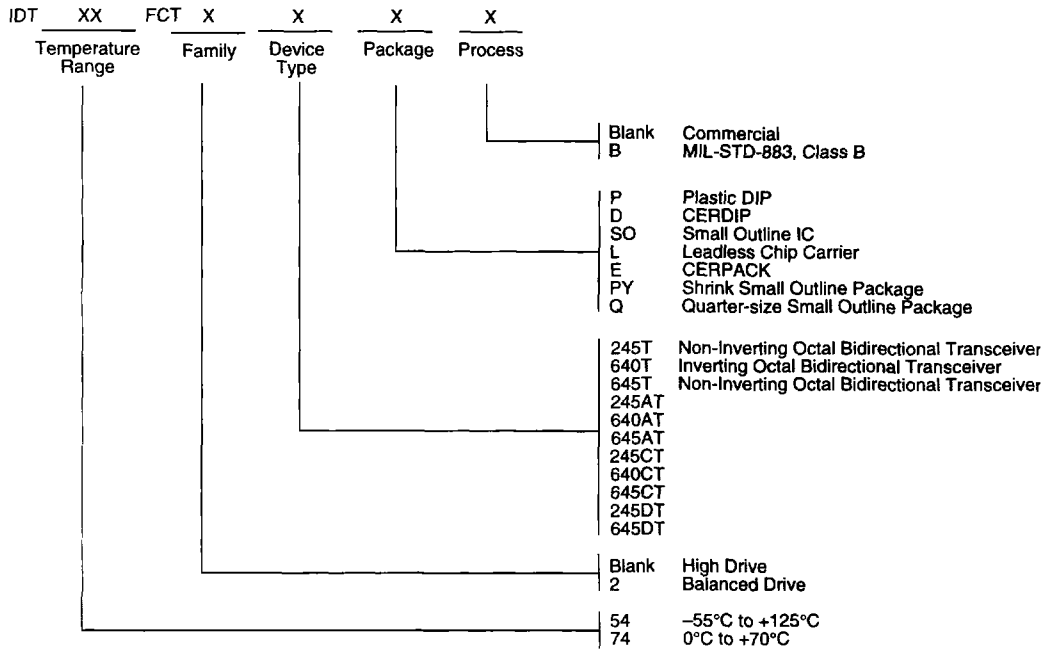

2539 drw 09

X-ON Electronics

Largest Supplier of Electrical and Electronic Components

Click to view similar products for [Bus Transceivers](#) category:

Click to view products by [IDT](#) manufacturer:

Other Similar products are found below :

[74LS645N](#) [DS8838](#) [FXL4TD245UMX](#) [IDT74CBTLV3257PGG](#) [74LVT245BBT20-13](#) [5962-8683401DA](#) [PCA9617ADMR2G](#) [5962-8953501KA](#) [5962-86834012A](#) [5962-7802301Q2A](#) [5962-7802002MFA](#) [5962-7802001MFA](#) [74VHCV245FT\(BJ\)](#) [NCV7349D13R2G](#) [TC74VCX164245\(EL,F](#) [MC74LCX245MNTWG](#) [TC7WPB8306L8X,LF\(S](#) [TC7WPB9307FC\(TE85L](#) [74FCT16245CTPVG8](#) [74FCT16543CTPVG](#) [74FCT245CTPYG8](#) [MM74HC245AMTCX](#) [74LVCH16245APVG](#) [74LVX245MTC](#) [5962-9221405M2A](#) [NTS0102DP-Q100H](#) [74ALVC16245MTDX](#) [74ALVCH32245BF](#) [74FCT163245APVG](#) [74FCT245ATPYG8](#) [74FCT245CTQG](#) [74FCT3245AQG](#) [74LCXR162245MTX](#) [74VHC245M](#) [74VHC245MX](#) [TC7WPB9306FC\(TE85L](#) [TC7WPB9306FK\(T5L,F](#) [JM38510/65553BRA](#) [ST3384EBDR](#) [74LVC1T45GF,132](#) [74AVC4TD245BQ,115](#) [PQJ7980AHN/C0JL,51](#) [MC100EP16VBDG](#) [FXL2TD245L10X](#) [74LVC1T45GM,115](#) [TC74AC245P\(F\)](#) [PSB21150F S LLHR](#) [SNJ54LS245FK](#) [SNJ54AHC245J](#) [SNJ54ABT245AFK](#)