

U.I. Lapp GmbH	<h1>DATASHEET</h1>	
	<b>EPIC KIT H-A 4 BS MAGS</b>	75009620 29.11.2013

H-A inserts with screw termination up to 2.5 mm<sup>2</sup> wire cross section  
The small H-A 3 / H-A 4 are used whenever there is minimal space.  
Easy to service screw connection  
Easy cable connection with strait cable entry in the contacts



Industrial machinery and plant engineering



Assembly time



Space requirement

### Info

Robust power supply connector  
Straight cable entry into the contacts

### Application range

Machine and equipment manufacturing  
Control engineering

### Remark

Photographs are not to scale and do not represent detailed images of the respective products.

### Technical Data

Article number:	75009620
Rated voltage (V):	IEC: 400 V UL: 600 V CSA: 600 V
Rated impulse voltage:	4 kV
Rated current (A):	IEC: 23 A UL: 10 A CSA: 10 A
Contact resistance:	1.5 - 4 mohm
Contacts:	Copper alloy, hard silver-plated
Number of contacts:	4 + PE
Termination methods:	Screw termination: 0.5 - 2.5 mm <sup>2</sup> (2.5 mm <sup>2</sup> with conductor end sleeves depending on the crimping profile)
Cycle of mechanical operation:	100
Temperature range:	-40 °C to +100 °C, short-term up to +125 °C
VDE-tested:	Certified production control: VDE-REG. no.: B437 UL-tested: UL File Number: E75770
Degree of soiling:	3

Product Management	Document: EPIC KIT H-A 4 BS MAGS	1 / 4
--------------------	----------------------------------	-------

U.I. Lapp GmbH	<h1>DATASHEET</h1>	
	<b>EPIC KIT H-A 4 BS MAGS</b>	75009620 29.11.2013



M

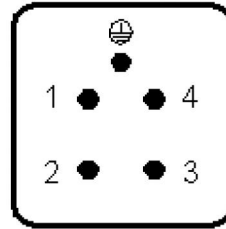

F

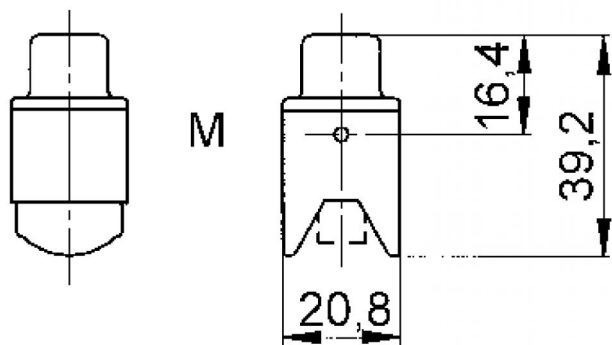
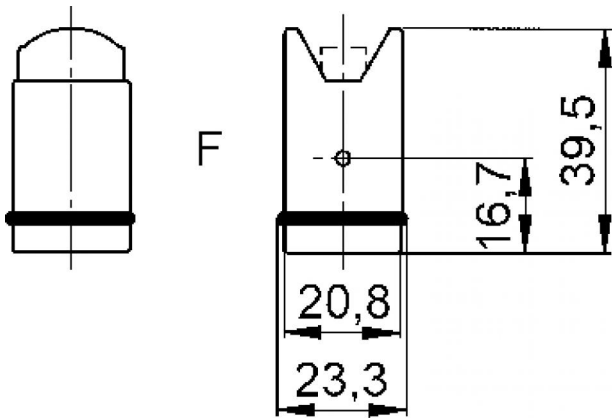
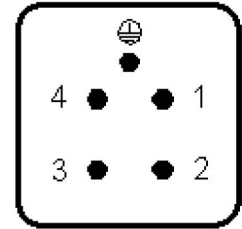

Product Management	Document: EPIC KIT H-A 4 BS MAGS	2 / 4
--------------------	----------------------------------	-------

U.I. Lapp GmbH	<h1>DATASHEET</h1>	
	<b>EPIC KIT H-A 4 BS MAGS</b>	75009620 29.11.2013

Innovative metal and plastic housing design  
Housing in plastic or metal version. For power supply in the smallest possible space

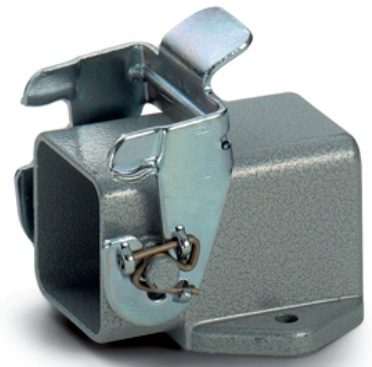

Industrial machinery and plant engineering



Mechanical resistance



Robust



Waterproof

### Info

Compact, robust metal- and plastic housings size H-A 3

### Application range

Machine and equipment manufacturing  
Control engineering  
Electronic laboratory

### Product features

Panel-mount base  
1 lever  
Angled version  
Included: flat gasket

### Remark

Photographs are not to scale and do not represent detailed images of the respective products.

### Technical Data

Article number:	75009620
Material:	Housing: powder-coated zinc die-casting, grey Lever: zinc-plated steel Sealing: NBR Housing: grey thermoplastic, black Lever: zinc-plated steel Sealing: NBR
Protection rating:	IP 65 (latched)
Temperature range:	-40 °C to +100 °C, short-term up to +125 °C
VDE-tested:	Certified production control: VDE-REG. no.: B437 UL-tested: UL File Number: E75770

Product Management	Document: EPIC KIT H-A 4 BS MAGS	3 / 4
--------------------	----------------------------------	-------

U.I. Lapp GmbH	<h1>DATASHEET</h1>	
	<b>EPIC KIT H-A 4 BS MAGS</b>	75009620 29.11.2013

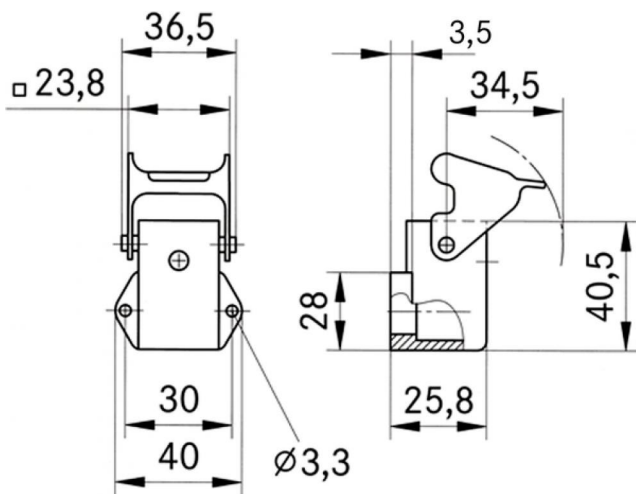

Product Management	Document: EPIC KIT H-A 4 BS MAGS	4 / 4
--------------------	----------------------------------	-------

## X-ON Electronics

Largest Supplier of Electrical and Electronic Components

*Click to view similar products for [Standard Circular Connector](#) category:*

*Click to view products by [Lapp Kabel](#) manufacturer:*

Other Similar products are found below :

[C015 10F006 001 1](#) [5M2530B10P](#) [600247N007](#) [600259N006](#) [600273N007](#) [600432N009](#) [6280-2PG-519](#) [6280-3PG-311](#) [6280-3SG-311](#)  
[6280-7SG-3DC](#) [6280-7SG-522](#) [6282-5PG-311](#) [6282-6PG-519](#) [6282-8SG-311](#) [6283-11](#) [6283-15](#) [6290](#) [6293](#) [6382-2PG-311](#) [6382-2PG-3DC](#)  
[6382-2SG-321](#) [6382-2SG-3DC](#) [6382-4SG-516](#) [67-03E20-37P](#) [681-PMG](#) [CXS3102A14S2P](#) [CXS3102A181S](#) [CXS3106A14S6S](#)  
[D38999/20FC8SA L/C](#) [MB12P-1](#) [MB12R-6](#) [7251-2PG-300](#) [7251-2SG-300](#) [7251-4PG-300](#) [7251-4SG-300](#) [7251-5PG-300](#) [7251-5SG-300](#)  
[7251-6SG-300](#) [7251-7PG-300](#) [7251-8PG-300](#) [7271-6SG-300](#) [7282-3PG-300-CH3](#) [73000005663](#) [75-190011-03P](#) [75-190216-08S](#) [75-190218-](#)  
[10P](#) [75-214636-52P](#) [75-474118-10P](#) [75-474211-03P](#) [75-474218-19S](#)