

U.I. Lapp GmbH	<h1>DATASHEET</h1>	
	EPIC® KIT M23 A1 12-POL MALE	75009703 29.11.2013

Inserts for M23 circular connectors

Universal further processing of the M23 inserts through different packaging units. Fully assembled with suitable solder contacts or unpopulated for individual assembly with crimp or solder contacts

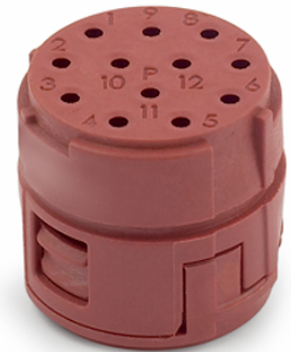

Good chemical resistance



Industrial machinery and plant engineering



Mechanical resistance



Assembly time



Robust



Wind Energy



Variety of approval certifications

Application range

Plant engineering
Measurement and control technology
Apparatus construction

Remark

The inserts are suitable for both male and female contacts. For a complete connection, you will need one P-component and one E-component. P-component = left turning (anticlockwise), E-component = right turning (clockwise)
Photographs are not to scale and do not represent detailed images of the respective products.

Product Management	Document: EPIC® KIT M23 A1 12-POL MALE	1 / 6
--------------------	--	-------

U.I. Lapp GmbH	DATASHEET	
	EPIC® KIT M23 A1 12-POL MALE	75009703 29.11.2013

Technical Data

Article number:	75009703
Rated voltage (V):	according to IEC 61984: 100 V
Rated impulse voltage:	1.5 kV
Rated current (A):	7 A
Contact resistance:	< 4 mOhm
Contacts:	Gold-plated brass
Number of contacts:	12
Termination methods:	Crimp termination: 0.14 - 1.0 mm ² Solder termination: up to 1.0 mm ²
Cycle of mechanical operation:	100
Temperature range:	-25°C až +125°C
VDE-tested:	Certified production control: VDE-REG. no. C24 (according to EN 61984, SELV according to DIN VDE 0100-410 has to be guaranteed) UL File Number: E249137
Degree of soiling:	3

Product Management	Document: EPIC® KIT M23 A1 12-POL MALE	2 / 6
--------------------	--	-------

U.I. Lapp GmbH	<h1>DATASHEET</h1>	
	EPIC® KIT M23 A1 12-POL MALE	75009703 29.11.2013



Product Management	Document: EPIC® KIT M23 A1 12-POL MALE	3 / 6
--------------------	--	-------

U.I. Lapp GmbH	DATASHEET	 LAPP GROUP
	EPIC® KIT M23 A1 12-POL MALE	75009703 29.11.2013

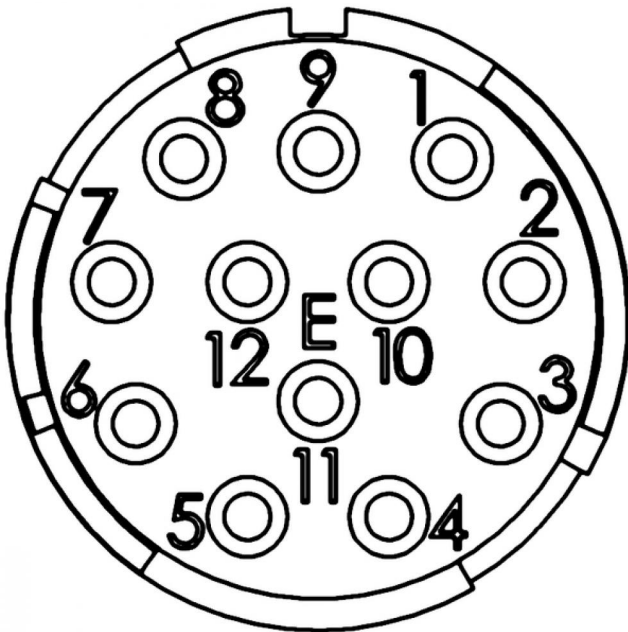
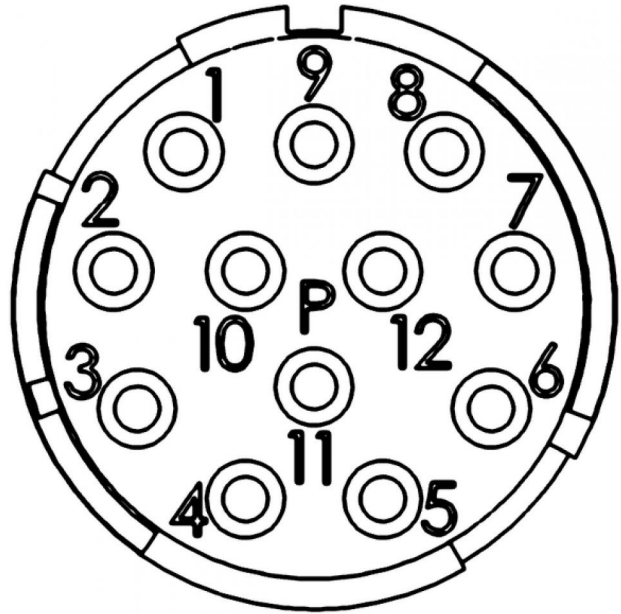

Product Management	Document: EPIC® KIT M23 A1 12-POL MALE	4 / 6
--------------------	--	-------

U.I. Lapp GmbH	<h1>DATASHEET</h1>	
	EPIC® KIT M23 A1 12-POL MALE	75009703 29.11.2013

Circular connectors for Servo Cables and encoders
 Safe fixing with 4 screws
 Permanent vibration protection



Good chemical resistance



Industrial machinery and plant engineering



Robust



Waterproof



Wind Energy



Variety of approval certifications



Info

Colour coding for easy connecting

Application range

Plant engineering
 Servo drives and servo assemblies
 Measurement and control technology

Remark

Photographs are not to scale and do not represent detailed images of the respective products.

Technical Data

Article number:	75009703
Material:	Housing: nickel-plated zinc die-casting Sealing: FPM
Protection rating:	IP68 (10h / 1m)
Temperature range:	-25°C až +125°C
VDE-tested:	Certified production control: VDE-REG. no. C24 (according to EN 61984, SELV according to DIN VDE 0100-410 has to be guaranteed) UL File Number: E249137

Product Management	Document: EPIC® KIT M23 A1 12-POL MALE	5 / 6
--------------------	--	-------

U.I. Lapp GmbH	<h1>DATASHEET</h1>	
	EPIC® KIT M23 A1 12-POL MALE	75009703 29.11.2013

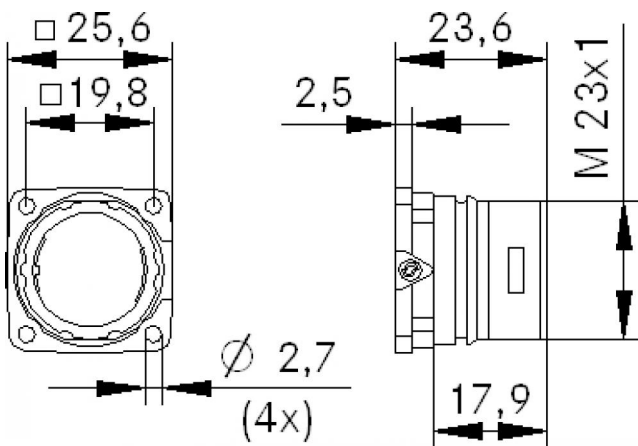
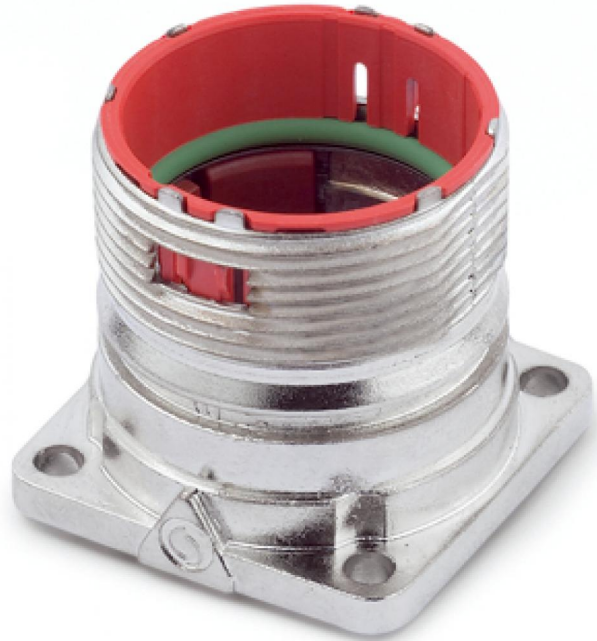
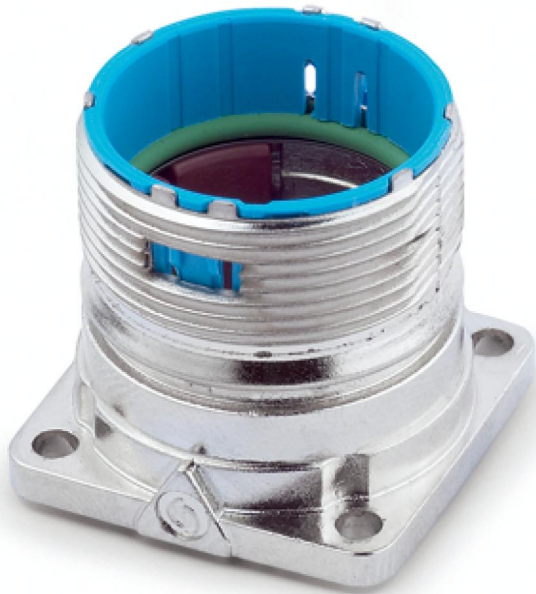

Product Management	Document: EPIC® KIT M23 A1 12-POL MALE	6 / 6
--------------------	--	-------

X-ON Electronics

Largest Supplier of Electrical and Electronic Components

Click to view similar products for [Circular MIL Spec Connector](#) category:

Click to view products by [Lapp Kabel](#) manufacturer:

Other Similar products are found below :

[89075GULPR](#) [0025-262-542](#) [0025-264-3014](#) [58-570121-04S](#) [0134-213-1208](#) [0134-213-2209](#) [0025-258-000](#) [60-042022-07P](#) [60-042022-19P](#)
[60-042022-23P](#) [60-042217-10P](#) [0114-201-1278](#) [012-0467-000](#) [602GB06EG24-61SN](#) [0134-201-1207](#) [0134-213-1006](#) [6104-207-2302](#) [6104-](#)
[208-1902](#) [61-168211-04P](#) [61-168617-10P](#) [6131-202-19149P](#) [6131-204-21149P](#) [6131-208-13149P](#) [6131-209-17149P](#) [6131-210-11149P](#) [6131-](#)
[211-19149P](#) [6131-216-19149P](#) [6131-259-21149P](#) [6131-259-23149P](#) [6131-265-17149P](#) [6131-265-19149P](#) [CS3100A18-1P-472](#) [CS3100A-36-](#)
[77P](#) [CS3101A-16-55P](#) [CS3102A-10SL-55P](#) [CS3102A-14S-58P](#) [CS3102A-32-17P](#) [CS3102A32-25S](#) [CS3102C18-4P-472](#)
[CS3106A10SL3S004](#) [CS3106A-18-73S](#) [CS3108A-14S-52S](#) [CS3108A-28-51S](#) [6162-233-1277](#) [6162-324-1231](#) [M243082296Z](#)
[M2884010AC1S1](#) [CT0-24-10SC](#) [CT0M20-7PCAU](#) [M28840/17AC1G3](#)