

Manual actuated valves

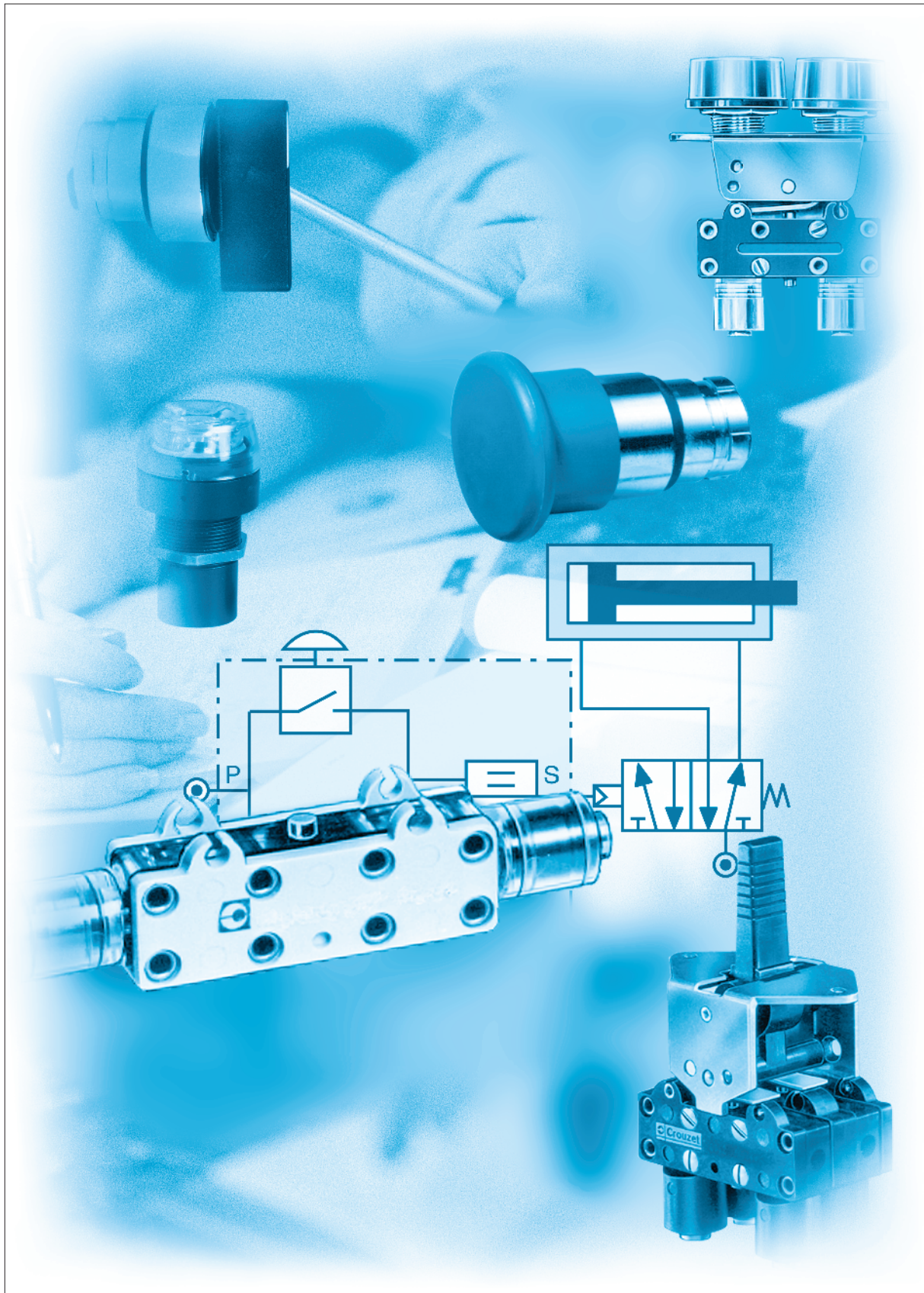

Push buttons diameter 12 and actuators

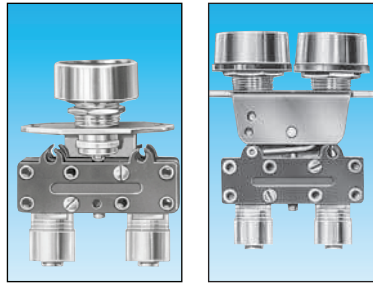

| Features | Actuator color | Valve color | Push button round | Push button double round |
|----------|----------------|-------------|-------------------|--------------------------|
| Version | NC | black | 81 735 511 | — |
| | | red | 81 735 512 | — |
| | | black/red | — | 81 733 511 |
| Version | NO | black | 81 735 011 | — |
| | | red | — | — |
| | | black/red | — | — |

Symbol

NC

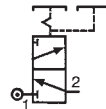
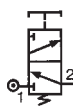

NO

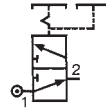
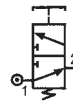

Characteristics

| | | | |
|--|-------------------------|-----------------------|-----------------------|
| Operating pressure | bar | 2 → 8 | 2 → 8 |
| Orifice diameter | mm | 2.7 | 2.7 |
| Flow at 6 bars | NI/mn. | 200 | 200 |
| Valves | NC : black NO : grey | • • | • • |
| Operating forces (depending on actuator) | N | 8 → 18 | 8 → 18 |
| Effective travel | mm | 1 | 1 |
| Fluid: dry or lubricated air | | • | • |
| Push-in connectors for semi-rigid tubing (NFE 49100) | mm | Ø 4 | Ø 4 |
| Operating temperature | °C | -5 → +50 | -5 → +50 |
| Mechanical life | operations | 1.5 x 10 ⁶ | 1.5 x 10 ⁶ |
| Weight | g | 35 | 40 |

Dimensions

81 735

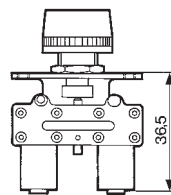

81 733

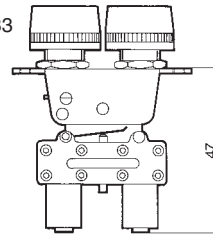

Threaded barrel

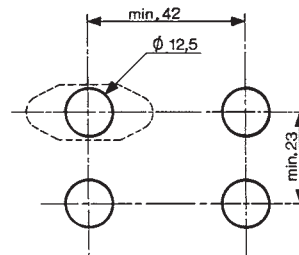

2 threaded barrels

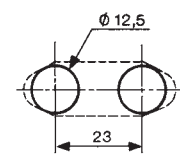

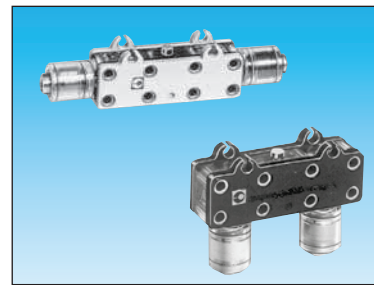
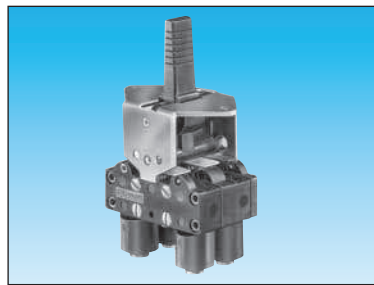
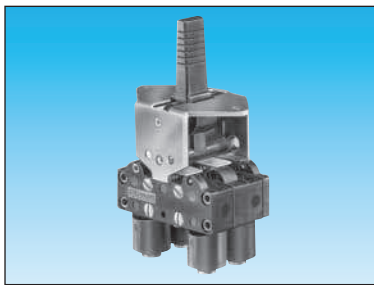

3-position lever
manual return

81 716 511
81 716 512

| | |
|---|---|
| — | — |
| — | — |
| — | — |
| — | — |

3-position lever
spring return

81 715 511
81 715 512

| | |
|---|---|
| — | — |
| — | — |
| — | — |
| — | — |

Horizontal outputs

81 280 510

| | |
|------------|---|
| — | — |
| — | — |
| 81 280 010 | — |
| — | — |

Vertical outputs

81 281 510

| | |
|------------|---|
| — | — |
| — | — |
| 81 281 010 | — |
| — | — |

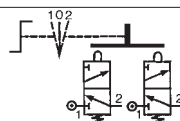
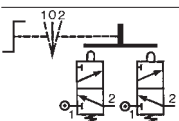

2 → 8
2.7
200

| | |
|-----------------------|---|
| • | — |
| • | — |
| 8 → 18 | — |
| 1 | — |
| • | — |
| Ø 4 | — |
| -5 → +50 | — |
| 1.5 x 10 ⁶ | — |
| 65 | — |

2 → 8
2.7
200

| | |
|-----------------------|---|
| • | — |
| • | — |
| 8 → 18 | — |
| 1 | — |
| • | — |
| Ø 4 | — |
| -5 → +50 | — |
| 1.5 x 10 ⁶ | — |
| 65 | — |

2 → 8
2.7
200

| | |
|-----------------------|---|
| — | — |
| — | — |
| — | — |
| 1 | — |
| — | — |
| Ø 4 | — |
| -5 → +50 | — |
| 1.5 x 10 ⁶ | — |
| 14 | — |

2 → 8
2.7
200

| | |
|-----------------------|---|
| — | — |
| — | — |
| — | — |
| 1 | — |
| — | — |
| Ø 4 | — |
| -5 → +50 | — |
| 1.5 x 10 ⁶ | — |
| 14 | — |

81 715 - 81 716

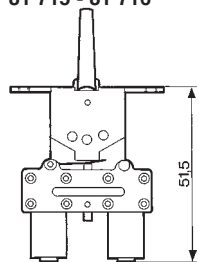

Square lever

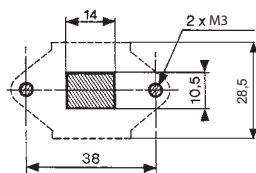

81 280 010 - 81 280 510

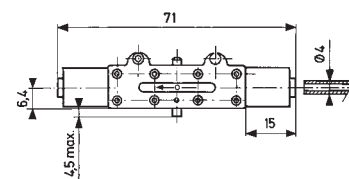

81 281 010 - 81 281 510

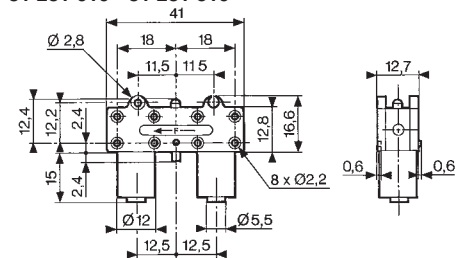

3/2 valves for manual actuators Ø 22 mm



| | | | | | | | | |
|---|---------------|------------|------------|------------|------------|------------|------------|------------|
| 3/2 valve supplied with screws for fixing the adaptor | Connection Ø4 | 89 543 501 | 89 543 101 | — | — | — | — | — |
| | Gas 1/8 | 89 543 701 | 89 543 201 | — | — | — | — | — |
| Valve(s) 3/2 fixed on adaptor (supplied with adaptor not assembled) | Connection Ø4 | — | — | 89 543 105 | 89 543 005 | 89 543 305 | 89 543 205 | — |
| Adaptor for 3/2 valve on actuators Ø 22 | | — | — | — | — | — | — | 24 679 702 |
| Version | | NC | NO | NC | NO | NC + NO | NC + NC | |

Symbol

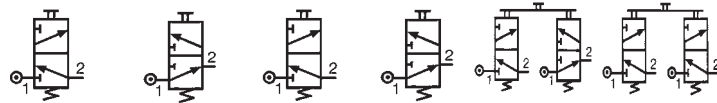

Characteristics

| | | | | | | | | |
|----------------------------------|------------|-----------------------|-----------------------|-----------------------|-----------------------|-----------------------|-----------------------|----|
| Operating pressure | bar | 0 → 8 | 0 → 8 | 0 → 8 | 0 → 8 | 0 → 8 | 0 → 8 | — |
| Orifice diameter | mm | 2 | 2 | 2 | 2 | 2 | 2 | — |
| Flow at 6 bars | NI/min | 112 | 112 | 112 | 112 | 112 | 112 | — |
| Control force | N | 12.6 | 12.6 | 12.6 | 12.6 | 12.6 | 12.6 | — |
| Operating temperature in dry air | °C | -5 → +60 | -5 → +60 | -5 → +60 | -5 → +60 | -5 → +60 | -5 → +60 | — |
| Life | operations | 1.5 x 10 ⁶ | 1.5 x 10 ⁶ | 1.5 x 10 ⁶ | 1.5 x 10 ⁶ | 1.5 x 10 ⁶ | 1.5 x 10 ⁶ | — |
| Non-connectable exhaust | | ● | ● | ● | ● | ● | ● | — |
| Weight | g | 50 | 50 | 60 | 60 | 110 | 110 | 40 |

Principle of operation

NC version

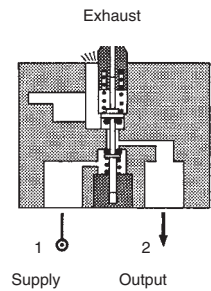

Dimensions

89 543 001 - 89 543 201
89 543 501 - 89 543 701

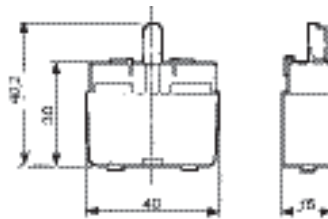

Ø 22 series

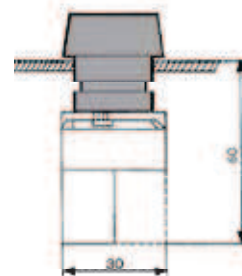

Holes drilled in panel for actuators Ø 22

EN 50007

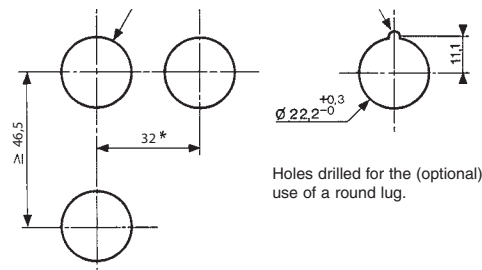



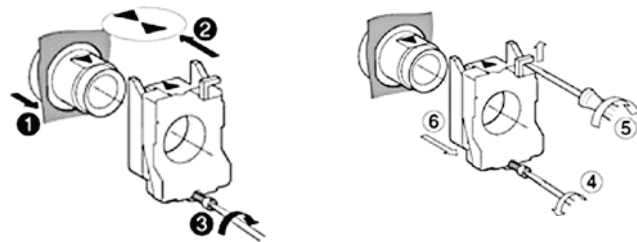

Holes drilled for the (optional) use of a round lug.

* > 40 Ø 40 push-buttons
* > 45 for lever type rotary switches

Installation



Actuators Ø 22 mm for manually operated valves

| | | | | | | |
|-----------------------------|---|---|--|---|---|------------------|
| |  |  |  |  |  | |
| Push buttons | Red Green Black | 24 678 129 24 678 128 24 678 127 | 24 678 173 — 24 678 172 | 24 678 171 — — | — — — | — — — |
| 2-positions rotary switches | | — | — | — | 24 678 174 | 24 678 175 |
| 3-positions rotary switches | | — | — | — | — | — |
| Function | | Flush push contact | Emergency stop plastic Ø 40 | Emergency stop Ø 40 mm push-turn | Black symmetrical actuator | Long lever Black |

Symbol



Position

| | | | | | | |
|--------|---|----|----|----|---|---|
| | | | | |  |  |
| Weight | g | 30 | 45 | 45 | 45 | 45 |

Dimensions







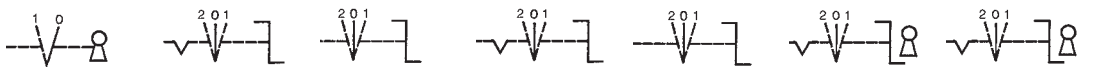

| | | | | | | | | |
|-----------------------------|---------------------------------------|----------------------------|--|------------------|------------------------------------|--|---|------------|
| 2-positions rotary switches | 24 678 180 | — | 24 678 176 | 24 678 178 | 24 678 177 | 24 678 179 | 24 678 182 | 24 678 181 |
| 3-positions rotary switches | — | — | — | — | — | — | — | — |
| Function | RONIS key 455 removable in position 0 | Black symmetrical actuator | Black symmetrical actuator with return | Long lever Black | Black Long lever, spring to center | RONIS key 455 remov. in pos. 0 3 positions with spring to center | RONIS key 455 removable in position 0 3 fixed positions | |

Symbol



Position

| | | | | | | | |
|--------|---|---|---|---|---|---|---|
| |  |  |  |  |  |  |  |
| Weight | 70 | 45 | 45 | 16 | 45 | 70 | 70 |

Dimensions

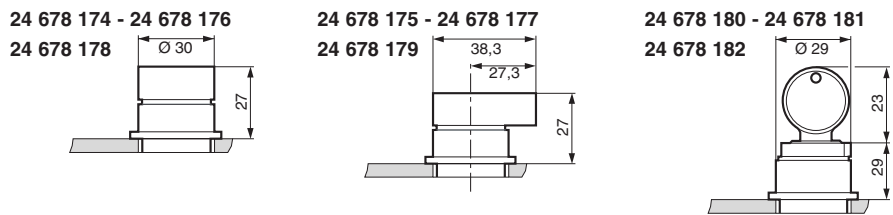

Pneumatic 2-hand control

Conforms to the Machinery Directive



Definition (conforming to EN 574 +A1)

A pneumatic 2-hand control device is used with dangerous machinery and requires the simultaneous use of both hands to trigger and maintain machine operation. Such a device must be located outside the dangerous zone, so that the operator cannot enter this zone before the machine has come to a complete standstill.

A pneumatic 2-hand control device is composed of 2 parts :

- 2 manual pushbuttons which require the simultaneous use of both hands.
- A pneumatic relay.

Types of 2-hand control devices

| Requirements | Type | | | | |
|--|------|----|-----|---|---|
| | I | II | III | | |
| | | | A | B | C |
| Use of both hands (simultaneous actuation) | ● | ● | ● | ● | ● |
| Relationship between input signals and output signal | ● | ● | ● | ● | ● |
| Cessation of the output signal | ● | ● | ● | ● | ● |
| Prevention of accidental operation | ● | ● | ● | ● | ● |
| Prevention of defeat | ● | ● | ● | ● | ● |
| Reinitiation of the output signal | | ● | ● | ● | ● |
| Synchronous actuation | | | ● | ● | ● |
| Use of category 1 (EN 954-1) | ● | | ● | | |
| Use of category 3 (EN 954-1) | | ● | | ● | |
| Use of category 4 (EN 954-1) | | | | | ● |

Category 1 (EN ISO 13849) : the system should use well tried components and principles.

Category 3 (EN ISO 13849) : the system must be designed so that a single fault will not cause the loss of the safety function.

Category 4 (EN ISO 13849): the system must be designed so that an accumulation of faults must not lead to a loss of the safety function.

Synchronous action

An output signal is only generated if both control actuating devices are actuated within 500 ms.

Resetting the output signal

The release of a single control device interrupts the output signal, but a reset is only possible once both control devices have been released.

Pneumatic relay for two-hand control

- 100% pneumatic
- Complies with Machinery Directive and the standard EN 574 +A1
- CE Certification type-IIIA and IIIB

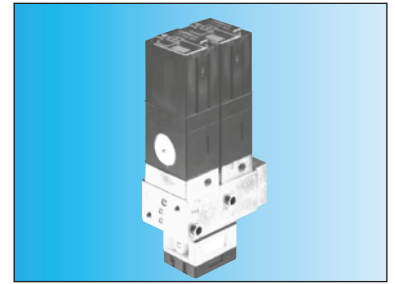
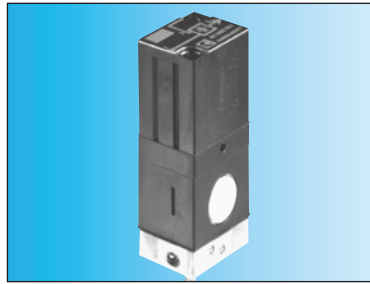

Pneumatic relay for two-hand control
EN 574 +A1 classification

81 580 101
III A

81 580 202
III B

Symbol

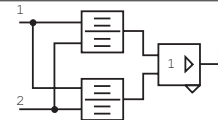

Characteristics

| | | | |
|----------------------------------|------------|---------------------|-----------------------------------|
| Operating pressure | bar | 2 → 8 | 2 → 8 |
| Orifice diameter | mm | 2.5 | 2.5 |
| Max. delay between input signals | s | 0.2 max. | 0.2 max. |
| Connection | | Sub-base 81 532 001 | Semi-rigid tubing Ø 4 (NFE 49100) |
| Operating temperature | °C | -5 → +50 | -5 → +50 |
| Mechanical life | operations | 10 ⁷ | 10 ⁷ |
| Weight | g | 90 | 320 |

Principle of operation

81 580 101

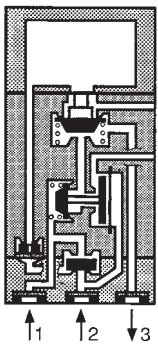

To obtain an output signal it is necessary to give simultaneous input signals 'a' and 'b' with a max. delay of 0.45. The output signal 's' is lost if one or both of the inputs are removed.

Connections (Typical application with double-acting cylinder)

81 580 101

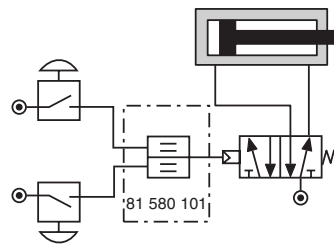

Components follow current standards

81 580 202

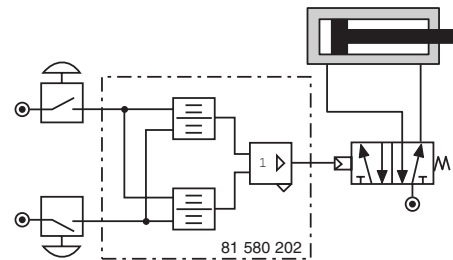

Dimensions

81 580 101

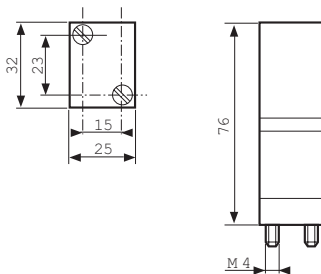

Mounted on sub-base 81 532 001
(See page 55 of Pneumatic catalogue)

81 580 202

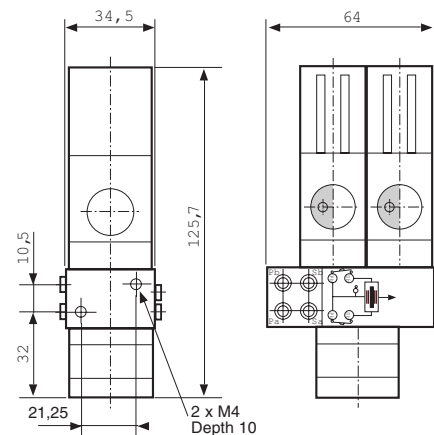

Two-hand pneumatic safety start module

- Conforms to the Machinery Directive and standard EN 574
- Including pneumatic relay to classification IIIA or IIIB depending on version

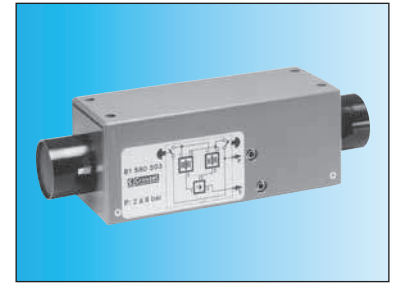
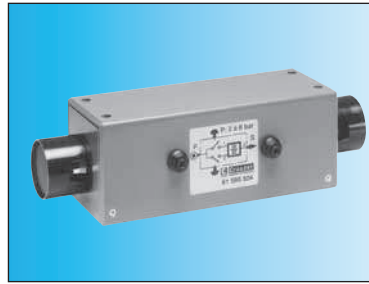

Two-hand pneumatic safety start module
Pneumatic relay (to EN 574)

81 580 504
Type III A

81 580 503
Type III B

Symbol

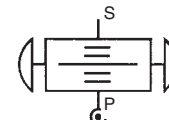
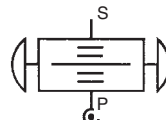

Characteristics

| | | | |
|----------------------------------|------------|-----------------------------------|-----------------------------------|
| Operating pressure | bar | 2 → 8 | 2 → 8 |
| Orifice diameter | mm | 2.5 | 2.5 |
| Max. delay between input signals | s | 0.2 max. | 0.2 max. |
| Connection | | Semi-rigid tubing Ø 4 (NFE 49100) | Semi-rigid tubing Ø 4 (NFE 49100) |
| Operating temperature | °C | -5 → +50 | -5 → +50 |
| Mechanical life | operations | 1.5 x 10 ⁶ | 1.5 x 10 ⁶ |
| Weight | g | 1000 | 1410 |

Connections (Typical application with double-acting cylinder)
81 580 504

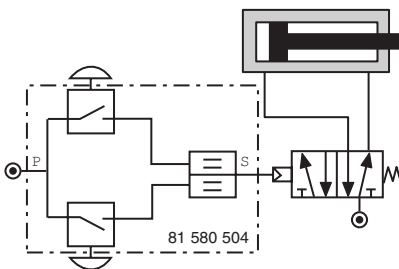

81 580 503

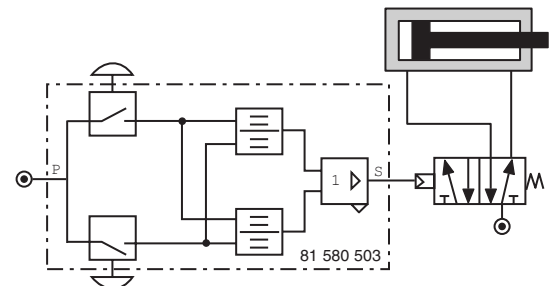

Components follow current standards

Dimensions

81 580 503 - 81 580 504

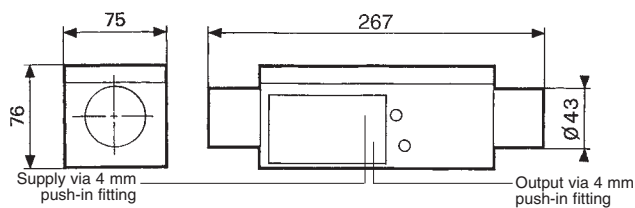

Fixing viewed from below

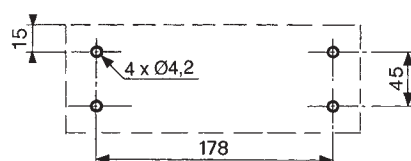

Pneumatic impulse counters

- 4, 5, 6 digits with or without reset
- With or without pre-selection

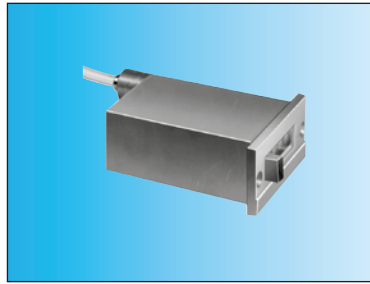

| | | | |
|----------------------|---------------------------|---------------------------------|--|
| Totalizer | 99 766 001 | 99 766 002 | 89 538 201 |
| Preselection counter | — | — | — |
| Version | 6 digits no reset to zero | 4 digits with manual zero reset | 5 digits with manual or pneumatic zero reset |

Symbol



Characteristics

| | | | | |
|---------------------------------------|-----|---------|---------|---------|
| Supply pressure | bar | 2 → 8 | 2 → 8 | 2 → 8 |
| Pressure to break | bar | > 0.3 | > 0.3 | > 0.15 |
| Pressure to make | bar | > 1.4 | > 1.4 | > 0.8 |
| Reset : | | | | |
| Minimum pressure | bar | — | — | 2 |
| Reset time | ms | — | — | 150 |
| Circuit pressure | bar | — | — | 2 → 8 |
| bar | | — | — | • |
| Signal emitted when preset is reached | | 0 → +60 | 0 → +60 | 0 → +60 |
| Operating temperature | °C | 150 | 150 | 136 |
| Weight | g | — | — | — |

Connection

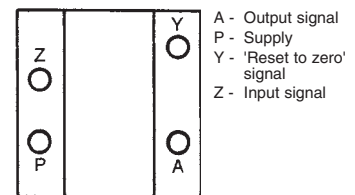

Note : the count pulse must be removed before the reset pulse is applied. The pre-set value can be changed during operation without the counter resetting to zero.

Dimensions

Connectors for semi-rigid tubing Ø 4 (NFE 49100)

99 766 002

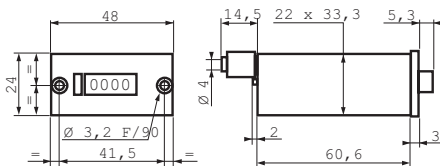

99 766 001

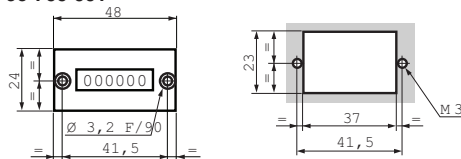

89 538 201

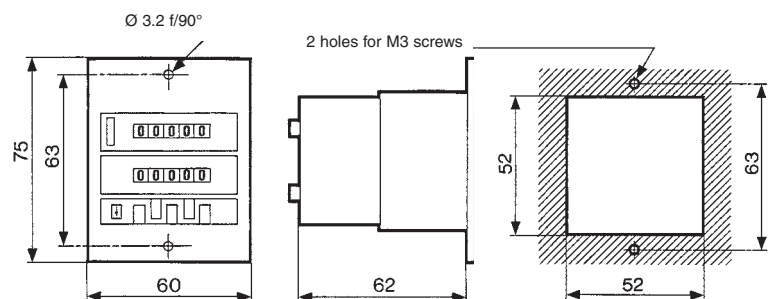

Indicators and pedal valves

Ergonomics



Also available in **ATEX** version for use in potentially explosive atmospheres in accordance with 94/9/EC Directive

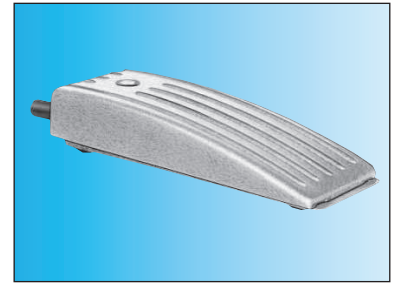

| | | | |
|---------------------------|--------|------------|------------|
| Pneumatic indicators Ø 22 | Red | 84 150 201 | — |
| | Green | 84 150 202 | — |
| | Yellow | 84 150 203 | — |
| | Blue | 84 150 204 | — |
| Pedal valve - Version NC | | — | 81 999 501 |

Symbol

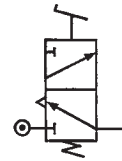

Characteristics

| | | | |
|--|------------|-----------------|-----------------------|
| Operating pressure | bar | 2 → 8 | — |
| Push-in connection for semi-rigid tubing (NFE 49100) | mm | Ø4 | Ø4 |
| Operating temperature | °C | -5 → +50 | -5 → +50 |
| Mechanical life | operations | 10 ⁷ | 1.5 x 10 ⁶ |
| Weight | g | 34 | 290 |

Dimensions

84 150 201 - 84 150 202
84 150 203 - 84 150 204

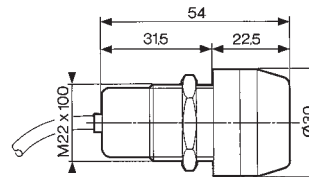

81 999 501

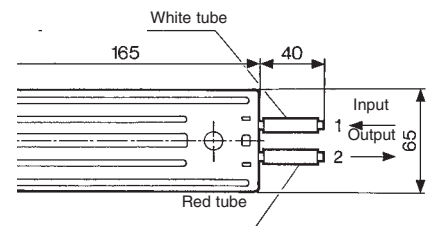

Holes drilled for indicators

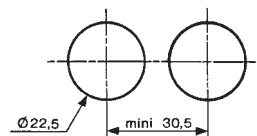

ATEX version products are available in the following catalogues: **Pneumatic products for explosive atmospheres** or on our website www.crouzet.com

X-ON Electronics

Largest Supplier of Electrical and Electronic Components

Click to view similar products for [Basic / Snap Action Switches](#) category:

Click to view products by [Crouzet](#) manufacturer:

Other Similar products are found below :

[83228001](#) [01.098.1358.1](#) [602EN1-6B](#) [602EN532](#) [602EN535-RB](#) [602HE5-RB1](#) [604HE162](#) [604HE223-6B](#) [624HE17-RB](#) [6HM89](#) [6PA78-JM](#)
[6SE1](#) [6SX1-H58](#) [70500840](#) [MBD5B1](#) [MBH2731](#) [73-316-0012](#) [79211759](#) [79211923](#) [79218589](#) [7AS12](#) [ML-1155](#) [ML-1376](#) [831010C3.0](#)
[831060C3.TL](#) [831090C2.EL](#) [83131904](#) [84212012](#) [8AS239](#) [8HM73-3](#) [903VB1-PG](#) [914CE1-6G](#) [PL-100](#) [11SM1077-H4](#) [11SM1077-H58](#)
[11SM1-TN107](#) [11SM405](#) [11SM703-T](#) [11SM8423-H2](#) [11SX37-T](#) [11SX48-H58](#) [11SX55-H58](#) [11SM2442-T](#) [11SM76-T](#) [11SM77-H58](#)
[11SM77-T](#) [11SM863-T](#) [11SM866](#) [11SX47-H58](#) [A7CN-1M-1-LEFT](#)