

Metallized Polypropylene (PP) RFI-Capacitors Class X2 in PCM 7.5 mm to 37.5 mm. Capacitances from 1000 pF to 10 µF. Rated Voltage 305 VAC.

Special Features

- Reliable self-healing
- High degree of interference suppression due to good attenuation and low ESR
- According to RoHS 2011/65/EU

Typical Applications

Class X2 RFI applications to meet EMC regulations

- Capacitors connected to the mains between phase and neutral or phase conductors
- General requirements, pulse peak voltage ≤ 2.5 kV

Construction

Dielectric:

Polypropylene (PP) film

Capacitor electrodes:

Vacuum-deposited

Internal construction:

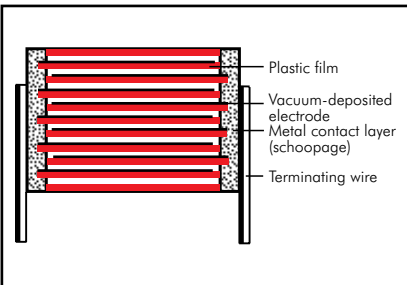

Encapsulation:

Solvent-resistant, flame-retardant plastic case with epoxy resin seal, UL 94 V-0

Terminations:

Tinned wire.

Marking:

Colour: Red. Marking: Black.

Electrical Data

Capacitance range: 1000 pF to 10 µF

Rated voltage: 305 VAC

Continuous DC voltage* (general guide): ≤ 560 V

Capacitance tolerances: $\pm 20\%$, $\pm 10\%$, $\pm 5\%$

Operating temperature range: -55°C to $+105^\circ\text{C}$

Climatic test category:

55/105/56 in accordance with IEC

Passive flammability class:

B for capacitors with $V > 1750$ mm³

C for capacitors with $V \leq 1750$ mm³

Test specifications:

In accordance with IEC 60384-14

Dissipation factors at $+20^\circ\text{C}$: $\tan \delta$

| at f | $C \leq 0.1 \mu\text{F}$ | $0.1 \mu\text{F} < C \leq 1.0 \mu\text{F}$ | $C > 1.0 \mu\text{F}$ |
|---------|---------------------------|--|--------------------------|
| 1 kHz | $\leq 15 \times 10^{-4}$ | $\leq 20 \times 10^{-4}$ | $\leq 30 \times 10^{-4}$ |
| 10 kHz | $\leq 20 \times 10^{-4}$ | $\leq 60 \times 10^{-4}$ | - |
| 100 kHz | $\leq 100 \times 10^{-4}$ | - | - |

Insulation resistance at $+20^\circ\text{C}$:

$C \leq 0.33 \mu\text{F}$: $\geq 15 \times 10^3 \text{ M}\Omega$

$C > 0.33 \mu\text{F}$: $\geq 5000 \text{ sec (M}\Omega \times \mu\text{F)}$

Measuring voltage: 100 V/1 min.

Maximum pulse rise time:

100 V/ μsec for pulses equal to a voltage

amplitude with $\sqrt{2} \times 305 \text{ VAC} = 432 \text{ V}$

according to IEC 60384-14

Test voltage:

$C \leq 1.0 \mu\text{F}$: 2260 VDC, 2 sec.



$C > 1.0 \mu\text{F}$: 1800 VDC, 2 sec.

Reliability:

Operational life $> 300\,000$ hours

Failure rate < 2 fit ($0.5 \times U_r$ and 40°C)

Approvals:

| Country | Authority | Specification | Symbol | Approval-No. |
|------------|-----------|----------------------------------|---|--------------|
| Germany | VDE | IEC 60384-14/4 |  | 40003472 |
| USA/Canada | UL | UL 60384-14 CAN/CSA-E60384-14 |  | E 134915 |

Mechanical Tests

Pull test on pins: 10 N in direction of pins according to IEC 60068-2-21

Vibration: 6 hours at 10...2000 Hz and 0.75 mm displacement amplitude or 10 g in accordance with IEC 60068-2-6

Low air density: 1kPa = 10 mbar in accordance with IEC 60068-2-13

Bump test: 4000 bumps at 390 m/sec² in accordance with IEC 60068-2-29

* If safety-approved EMI suppression capacitors are operated with a DC voltage being above the specified AC voltage rating the given approvals are no longer valid (IEC 60384-14).

Furthermore the permissible pulse rise time $du/dt (F_{\text{max}})$ will be subject to a reduction according to

$$F_{\text{max}} = F_r \times \sqrt{2} \times \text{UAC} / \text{UDC}$$

if the DC operating voltage UDC is higher than $\sqrt{2} \times \text{UAC}$

Packing

Available taped and reeled up to and including case size 15 x 26 x 31.5 / PCM 27.5 mm.

Detailed taping information and graphs at the end of the catalogue.

For further details and graphs please refer to Technical Information.

Continuation

General Data

| Capacitance | 305 VAC* | | | | | Part number |
|-------------|----------|------|------|------------|---------------------|-------------|
| | W | H | L | PCM** | | |
| 1000 pF | 4 | 9 | 10 | 7.5 | MKX2AW11002C00_____ | |
| 1200 " | 4 | 9 | 10 | 7.5 | MKX2AW11202C00_____ | |
| 1500 " | 4 | 9 | 10 | 7.5 | MKX2AW11502C00_____ | |
| 1800 " | 4 | 9 | 10 | 7.5 | MKX2AW11802C00_____ | |
| 2200 " | 4 | 9 | 10 | 7.5 | MKX2AW12202C00_____ | |
| 2700 " | 4 | 9 | 10 | 7.5 | MKX2AW12702C00_____ | |
| 3300 " | 4 | 9 | 10 | 7.5 | MKX2AW13302C00_____ | |
| 3900 " | 4 | 9 | 10 | 7.5 | MKX2AW13902C00_____ | |
| 4700 " | 4 | 9 | 10 | 7.5 | MKX2AW14702C00_____ | |
| 5600 " | 4 | 9 | 10 | 7.5 | MKX2AW15602C00_____ | |
| 6800 " | 4 | 9 | 10 | 7.5 | MKX2AW16802C00_____ | |
| 8200 " | 4 | 9 | 10 | 7.5 | MKX2AW18202C00_____ | |
| 0.01 µF | 4 | 9 | 10 | 7.5 | MKX2AW21002C00_____ | |
| | 5 | 11 | 13 | 10 | MKX2AW21003F00_____ | |
| 0.012 " | 4 | 9 | 10 | 7.5 | MKX2AW21202C00_____ | |
| | 5 | 11 | 13 | 10 | MKX2AW21203F00_____ | |
| 0.015 " | 4 | 9 | 10 | 7.5 | MKX2AW21502C00_____ | |
| | 5 | 11 | 13 | 10 | MKX2AW21503F00_____ | |
| 0.018 " | 4 | 9 | 10 | 7.5 | MKX2AW21802C00_____ | |
| | 5 | 11 | 13 | 10 | MKX2AW21803F00_____ | |
| 0.022 " | 4 | 9 | 10 | 7.5 | MKX2AW22202C00_____ | |
| | 5 | 11 | 13 | 10 | MKX2AW22203F00_____ | |
| 0.027 " | 5 | 10.5 | 10.3 | 7.5 | MKX2AW22702E00_____ | |
| | 5 | 11 | 13 | 10 | MKX2AW22703F00_____ | |
| 0.033 " | 5 | 10.5 | 10.3 | 7.5 | MKX2AW23302E00_____ | |
| | 5 | 11 | 13 | 10 | MKX2AW23303F00_____ | |
| 0.039 " | 5.7 | 12.5 | 10.3 | 7.5 | MKX2AW23902F00_____ | |
| | 5 | 11 | 13 | 10 | MKX2AW23903F00_____ | |
| 0.047 " | 5.7 | 12.5 | 10.3 | 7.5 | MKX2AW24702F00_____ | |
| | 6 | 12.5 | 13 | 10 | MKX2AW24703H00_____ | |
| | 5 | 11 | 18 | 15 | MKX2AW24704B00_____ | |
| 0.056 " | 6 | 12.5 | 13 | 10 | MKX2AW25603H00_____ | |
| | 5 | 11 | 18 | 15 | MKX2AW25604B00_____ | |
| 0.068 " | 6 | 12.5 | 13 | 10 | MKX2AW26803H00_____ | |
| | 5 | 11 | 18 | 15 | MKX2AW26804B00_____ | |
| 0.082 " | 6 | 12.5 | 13 | 10 | MKX2AW28203H00_____ | |
| | 5 | 11 | 18 | 15 | MKX2AW28204B00_____ | |

* f = 50/60 Hz

** PCM = Printed circuit module = pin spacing

Dims. in mm.

d = 0.6 ϕ if PCM < 15
d = 0.8 ϕ if PCM \geq 15

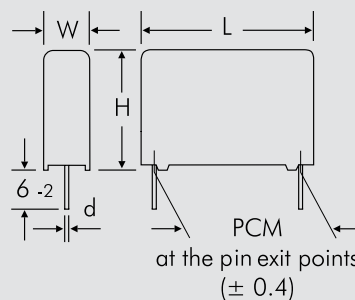

| Part number completion: | |
|-----------------------------|----------|
| Tolerance: | 20 % = M |
| | 10 % = K |
| | 5 % = J |
| Packing: | bulk = S |
| Pin length: | 6-2 = SD |
| Taped version see page 145. | |

Rights reserved to amend design data without prior notification.

Continuation

General Data

| Capacitance | 305 VAC* | | | | | Part number |
|-------------|----------|------|------|-------|---------------------|---------------------|
| | W | H | L | PCM** | | |
| 0.1 μ F | 8 | 12 | 13 | 10 | MKX2AW31003I00_____ | |
| | 5 | 11 | 18 | 15 | MKX2AW31004B00_____ | |
| | 6 | 12.5 | 18 | 15 | MKX2AW31004C00_____ | |
| 0.12 " | 6 | 12.5 | 18 | 15 | MKX2AW31204C00_____ | |
| | 0.15 " | 6 | 12.5 | 18 | 15 | MKX2AW31504C00_____ |
| 0.18 " | | 8 | 15 | 18 | 15 | MKX2AW31504F00_____ |
| | 6 | 15 | 26.5 | 22.5 | MKX2AW31505B00_____ | |
| | 8 | 15 | 18 | 15 | MKX2AW31804F00_____ | |
| 0.22 " | 6 | 15 | 26.5 | 22.5 | MKX2AW31805B00_____ | |
| | 0.27 " | 9 | 14 | 18 | 15 | MKX2AW32204H00_____ |
| 0.33 " | | 8 | 15 | 18 | 15 | MKX2AW32204F00_____ |
| | 6 | 15 | 26.5 | 22.5 | MKX2AW32205B00_____ | |
| | 8 | 15 | 18 | 15 | MKX2AW32704F00_____ | |
| 0.39 " | 7 | 16.5 | 26.5 | 22.5 | MKX2AW32705D00_____ | |
| | 0.47 " | 11 | 14 | 18 | 15 | MKX2AW33304M00_____ |
| 9 | | 16 | 18 | 15 | MKX2AW33304J00_____ | |
| 7 | | 16.5 | 26.5 | 22.5 | MKX2AW33305D00_____ | |
| 0.56 " | 8.5 | 18.5 | 26.5 | 22.5 | MKX2AW33905F00_____ | |
| | 0.68 " | 8.5 | 18.5 | 26.5 | 22.5 | MKX2AW34705F00_____ |
| 10.5 | | 19 | 26.5 | 22.5 | MKX2AW34705G00_____ | |
| 9 | | 19 | 31.5 | 27.5 | MKX2AW34706A00_____ | |
| 0.82 " | 10.5 | 19 | 26.5 | 22.5 | MKX2AW35605G00_____ | |
| | 0.82 " | 9 | 19 | 31.5 | 27.5 | MKX2AW35606A00_____ |
| 10.5 | | 19 | 26.5 | 22.5 | MKX2AW36805G00_____ | |
| 11 | | 21 | 26.5 | 22.5 | MKX2AW36805I00_____ | |
| 0.82 " | 9 | 19 | 31.5 | 27.5 | MKX2AW36806A00_____ | |
| | 11 | 21 | 26.5 | 27.5 | MKX2AW38205I00_____ | |
| 0.82 " | 9 | 19 | 31.5 | 27.5 | MKX2AW38206A00_____ | |

* f = 50/60 Hz

** PCM = Printed circuit module = pin spacing

Dims. in mm.

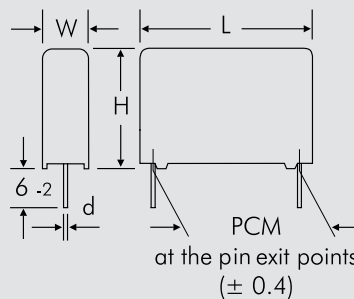

d = 0.6 ϕ if PCM = 10
d = 0.8 ϕ if PCM \geq 15

| Part number completion: | |
|-----------------------------|----------|
| Tolerance: | 20 % = M |
| | 10 % = K |
| | 5 % = J |
| Packing: | bulk = S |
| Pin length: | 6-2 = SD |
| Taped version see page 145. | |

Rights reserved to amend design data without prior notification.

Continuation page 79

Continuation

General Data

| Capacitance | 305 VAC* | | | | |
|-------------|----------|------|------|-------|---------------------|
| | W | H | L | PCM** | Part number |
| 1.0 μ F | 11 | 21 | 26.5 | 22.5 | MKX2AW41005I00_____ |
| | 11 | 21 | 31.5 | 27.5 | MKX2AW41006B00_____ |
| | 13 | 24 | 31.5 | 27.5 | MKX2AW41006D00_____ |
| 1.2 " | 11 | 21 | 31.5 | 27.5 | MKX2AW41206B00_____ |
| | 13 | 24 | 31.5 | 27.5 | MKX2AW41506D00_____ |
| 1.5 " | 15 | 26 | 31.5 | 27.5 | MKX2AW41506F00_____ |
| | 13 | 24 | 41.5 | 37.5 | MKX2AW41507C00_____ |
| | 13 | 24 | 31.5 | 27.5 | MKX2AW41806D00_____ |
| 1.8 " | 13 | 24 | 41.5 | 37.5 | MKX2AW41807C00_____ |
| | 15 | 26 | 31.5 | 27.5 | MKX2AW42206F00_____ |
| 2.2 " | 17 | 29 | 31.5 | 27.5 | MKX2AW42206G00_____ |
| | 13 | 24 | 41.5 | 37.5 | MKX2AW42207C00_____ |
| | 15 | 26 | 41.5 | 37.5 | MKX2AW42207D00_____ |
| 2.7 " | 17 | 29 | 31.5 | 27.5 | MKX2AW42706G00_____ |
| | 15 | 26 | 41.5 | 37.5 | MKX2AW42707D00_____ |
| | 17 | 29 | 41.5 | 37.5 | MKX2AW42707E00_____ |
| 3.3 " | 17 | 34.5 | 31.5 | 27.5 | MKX2AW43306I00_____ |
| | 20 | 39.5 | 31.5 | 27.5 | MKX2AW43306J00_____ |
| | 15 | 26 | 41.5 | 37.5 | MKX2AW43307D00_____ |
| 3.9 " | 17 | 29 | 41.5 | 37.5 | MKX2AW43307E00_____ |
| | 17 | 34.5 | 31.5 | 27.5 | MKX2AW43906I00_____ |
| | 17 | 29 | 41.5 | 37.5 | MKX2AW43907E00_____ |
| 4.7 " | 19 | 32 | 41.5 | 37.5 | MKX2AW43907F00_____ |
| | 20 | 39.5 | 31.5 | 27.5 | MKX2AW44706J00_____ |
| | 19 | 32 | 41.5 | 37.5 | MKX2AW44707F00_____ |
| 5.6 " | 20 | 39.5 | 41.5 | 37.5 | MKX2AW44707G00_____ |
| | 19 | 32 | 41.5 | 37.5 | MKX2AW45607F00_____ |
| | 20 | 39.5 | 41.5 | 37.5 | MKX2AW45607G00_____ |
| 6.8 " | 20 | 39.5 | 41.5 | 37.5 | MKX2AW46807G00_____ |
| | 24 | 45.5 | 41.5 | 37.5 | MKX2AW46807H00_____ |
| | 24 | 45.5 | 41.5 | 37.5 | MKX2AW48207H00_____ |
| 8.2 " | 31 | 46 | 41.5 | 37.5 | MKX2AW48207I00_____ |
| | 24 | 45.5 | 41.5 | 37.5 | MKX2AW51007H00_____ |
| 10 μ F | 24 | 45.5 | 41.5 | 37.5 | MKX2AW51007I00_____ |
| | 31 | 46 | 41.5 | 37.5 | MKX2AW51007I00_____ |

* f = 50/60 Hz

** PCM = Printed circuit module = pin spacing

Dims. in mm.

d = 0.8 ϕ if PCM \leq 27.5
d = 1.0 ϕ if PCM = 37.5

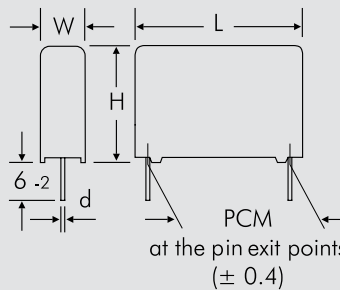

| Part number completion: | |
|-----------------------------|----------|
| Tolerance: | 20 % = M |
| | 10 % = K |
| | 5 % = J |
| Packing: | bulk = S |
| Pin length: | 6-2 = SD |
| Taped version see page 145. | |

Rights reserved to amend design data without prior notification.

Recommendation for Processing and Application of Through-Hole Capacitors

Soldering Process

Internal temperature of the capacitor must be kept as follows:

Polyester: preheating: $T_{max.} \leq 125^{\circ}C$
soldering: $T_{max.} \leq 135^{\circ}C$

Polypropylene: preheating: $T_{max.} \leq 100^{\circ}C$
soldering: $T_{max.} \leq 110^{\circ}C$

Single wave soldering

Soldering bath temperature: $T < 260^{\circ}C$
Dwell time: $t < 5 \text{ sec}$

Double wave soldering

Soldering bath temperature: $T < 260^{\circ}C$
Dwell time: $\Sigma t < 5 \text{ sec}$

Due to different soldering processes and heat requirements the graphs are to be regarded as a recommendation only.

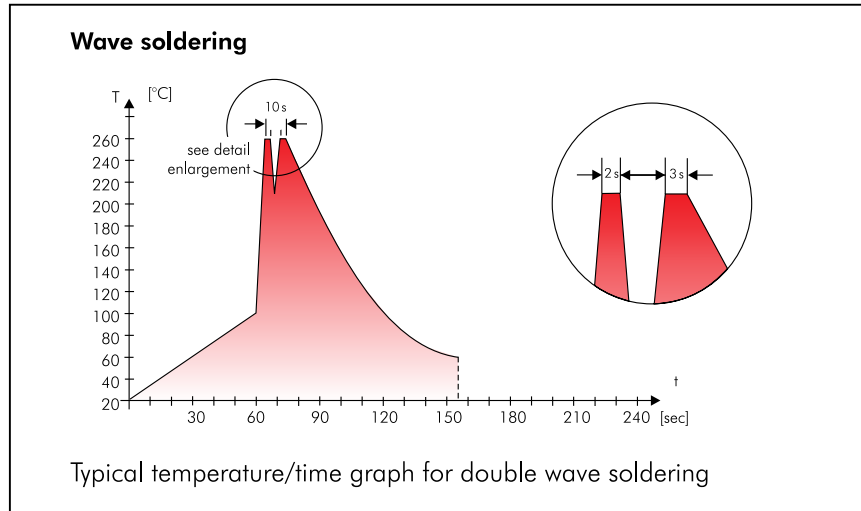

WIMA Quality and Environmental Philosophy

ISO 9001:2008 Certification

ISO 9001:2008 is an international basic standard of quality assurance systems for all branches of industry. The approval according to ISO 9001:2008 of our factories by the infaz (Institut für Auditierung und Zertifizierung) certifies that organisation, equipment and monitoring of quality assurance in our factories correspond to internationally recognized standards.

WIMA WPCS

The WIMA Process Control System (WPCS) is a quality surveillance and optimization system developed by WIMA. WPCS is a major part of the quality-oriented WIMA production. Points of application during production process:

- incoming material inspection
- metallization
- film inspection
- schoopage
- pre-healing
- pin attachment
- cast resin preparation/encapsulation
- 100% final inspection
- Testing as per customer requirements

WIMA Environmental Policy

All WIMA capacitors, irrespective of whether through-hole devices or SMD, are made of environmentally friendly materials. Neither during manufacture nor in the product itself any toxic substances are used, e.g.

- Lead
- PCB
- CFC
- Hydrocarbon chloride
- Chromium 6+
- PBB/PBDE
- Arsenic
- Cadmium
- Mercury
- etc.

We merely use pure, recyclable materials for packing our components, such as:

- carton
- cardboard
- adhesive tape made of paper
- polystyrene

We almost completely refrain from using packing materials such as:

- foamed polystyrene (Styropor®)
- adhesive tapes made of plastic
- metal clips

RoHS Compliance

According to the RoHS Directive 2011/65/EU certain hazardous substances like e.g. lead, cadmium, mercury must not be used any longer in electronic equipment as of July 1st, 2006. For the sake of the environment WIMA has refrained from using such substances since years already.



WIMA Kondensatoren sind bleifrei konform RoHS 2011/65/EU

WIMA capacitors are lead free in accordance with RoHS 2011/65/EU

Tape for lead-free WIMA capacitors

DIN EN ISO 14001:2004

WIMA's environmental management has been established in accordance with the guidelines of DIN EN ISO 14001:2004 to optimize the production processes with regard to energy and resources.

Typical Dimensions for Taping Configuration

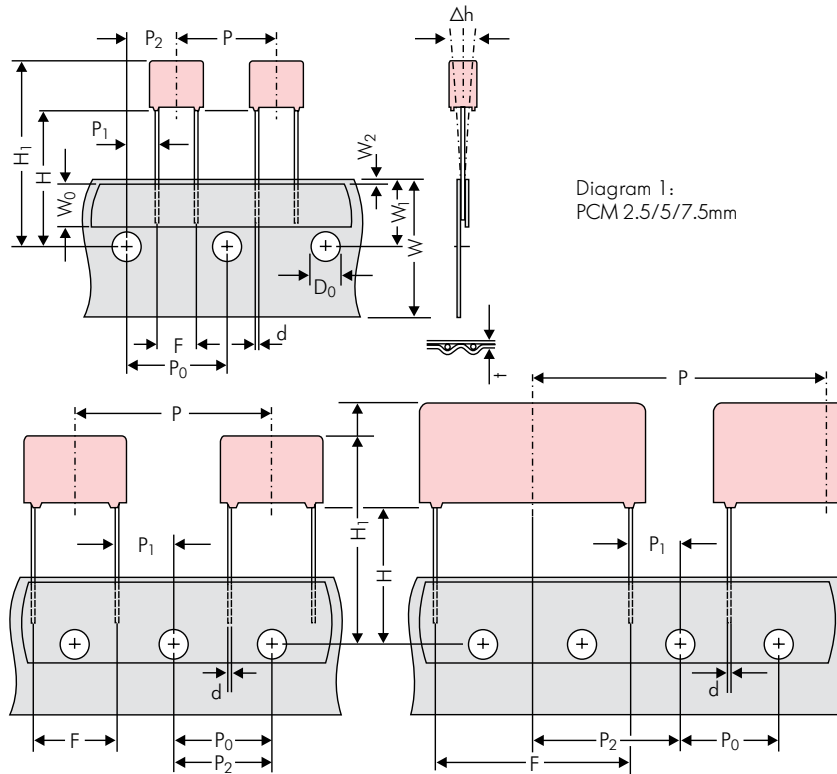

Diagram 1:
PCM 2.5/5/7.5mm

Diagram 2: PCM 10/15 mm

Diagram 3: PCM 22.5 and 27.5*mm

*PCM 27.5 taping possible with two feed holes between components

| Designation | Symbol | Dimensions for Radial Taping | | | | | | |
|--|-----------------------|--|--|---|---|---|---|---|
| | | PCM 2.5 taping | PCM 5 taping | PCM 7.5 taping | PCM 10 taping* | PCM 15 taping* | PCM 22.5 taping | PCM 27.5 taping |
| Carrier tape width | W | 18.0 ±0.5 | 18.0 ±0.5 | 18.0 ±0.5 | 18.0 ±0.5 | 18.0 ±0.5 | 18.0 ±0.5 | 18.0 ±0.5 |
| Hold-down tape width | W ₀ | 6.0 for hot-sealing adhesive tape | 6.0 for hot-sealing adhesive tape | 12.0 for hot-sealing adhesive tape | 12.0 for hot-sealing adhesive tape | 12.0 for hot-sealing adhesive tape | 12.0 for hot-sealing adhesive tape | 12.0 for hot-sealing adhesive tape |
| Hole position | W ₁ | 9.0 ±0.5 | 9.0 ±0.5 | 9.0 ±0.5 | 9.0 ±0.5 | 9.0 ±0.5 | 9.0 ±0.5 | 9.0 ±0.5 |
| Hold-down tape position | W ₂ | 0.5 to 3.0 max. | 0.5 to 3.0 max. | 0.5 to 3.0 max. | 0.5 to 3.0 max. | 0.5 to 3.0 max. | 0.5 to 3.0 max. | 0.5 to 3.0 max. |
| Feed hole diameter | D ₀ | 4.0 ±0.2 | 4.0 ±0.2 | 4.0 ±0.2 | 4.0 ±0.2 | 4.0 ±0.2 | 4.0 ±0.2 | 4.0 ±0.2 |
| Pitch of component | P | 12.7 ±1.0 | 12.7 ±1.0 | 12.7 ±1.0 | 25.4 ±1.0 | 25.4 ±1.0 | 38.1 ±1.5 | 38.1 ±1.5 or 50.8 ±1.5 |
| Feed hole pitch | P ₀ | 12.7 ±0.3 cumulative pitch error max. 1.0 mm/20 pitch | 12.7 ±0.3 cumulative pitch error max. 1.0 mm/20 pitch | 12.7 ±0.3 cumulative pitch error max. 1.0 mm/20 pitch | 12.7 ±0.3 cumulative pitch error max. 1.0 mm/20 pitch | 12.7 ±0.3 cumulative pitch error max. 1.0 mm/20 pitch | 12.7 ±0.3 cumulative pitch error max. 1.0 mm/20 pitch | 12.7 ±0.3 cumulative pitch error max. 1.0 mm/20 pitch |
| Feed hole centre to pin | P ₁ | 5.1 ±0.5 | 3.85 ±0.7 | 2.6 ±0.7 | 7.7 ±0.7 | 5.2 ±0.7 | 7.8 ±0.7 | 5.3 ±0.7 |
| Hole centre to component centre | P ₂ | 6.35 ±1.3 | 6.35 ±1.3 | 6.35 ±1.3 | 12.7 ±1.3 | 12.7 ±1.3 | 19.05 ±1.3 | 19.05 ±1.3 |
| Feed hole centre to bottom edge of the component | H | 16.5 ±0.3 18.5 ±0.5 | 16.5 ±0.3 18.5 ±0.5 | 16.5 ±0.5 18.5 ±0.5 | 16.5 ±0.5 18.5 ±0.5 | 16.5 ±0.5 18.5 ±0.5 | 16.5 ±0.5 18.5 ±0.5 | 16.5 ±0.5 18.5 ±0.5 |
| Feed hole centre to top edge of the component | H ₁ | H+H _{component} < H ₁ 32.25 max. | H+H _{component} < H ₁ 32.25 max. | H+H _{component} < H ₁ 24.5 to 31.5 | H+H _{component} < H ₁ 25.0 to 31.5 | H+H _{component} < H ₁ 26.0 to 37.0 | H+H _{component} < H ₁ 30.0 to 43.0 | H+H _{component} < H ₁ 35.0 to 45.0 |
| Pin spacing at upper edge of carrier tape | F | 2.5 ±0.5 | 5.0 ^{+0.8} _{-0.2} | 7.5 ±0.8 | 10.0 ±0.8 | 15 ±0.8 | 22.5 ±0.8 | 27.5 ±0.8 |
| Pin diameter | d | 0.4 ±0.05 | 0.5 ±0.05 | 0.5 ±0.05 or 0.6 ^{+0.06} _{-0.05} | 0.5 ±0.05 or 0.6 ^{+0.06} _{-0.05} | 0.8 ^{+0.08} _{-0.05} | 0.8 ^{+0.08} _{-0.05} | 0.8 ^{+0.08} _{-0.05} |
| Component alignment | Δh | ± 2.0 max. | ± 2.0 max. | ± 3.0 max. | ± 3.0 max. | ± 3.0 max. | ± 3.0 max. | ± 3.0 max. |
| Total tape thickness | t | 0.7 ±0.2 | 0.7 ±0.2 | 0.7 ±0.2 | 0.7 ±0.2 | 0.7 ±0.2 | 0.7 ±0.2 | 0.7 ±0.2 |
| Package (see also page 146) | ROLL/AMMO | | | AMMO | | | | |
| | REEL | φ 360 max. φ 30 ±1 | B 52 ±2 58 ±2 } depending on comp. dimensions | REEL | φ 360 max. φ 30 ±1 | 52 ±2 58 ±2 or 66 ±2 | REEL | φ 500 max. φ 25 ±1 |
| Unit | see details page 147. | | | | | | | |

Dims in mm.

* Diameter of pins see General Data.

* PCM 10 and PCM 15 can be crimped to PCM 7.5.

Position of components according to PCM 7.5 (sketch 11). P₀ = 12.7 or 15.0 is possible

Please clarify customer-specific deviations with the manufacturer.

Types of Tape Packaging of Capacitors for Automatic Radial Insertion

■ ROLL Packaging

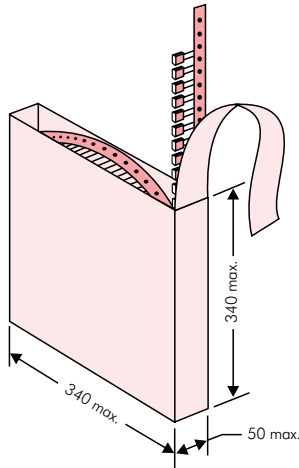

■ AMMO Packaging

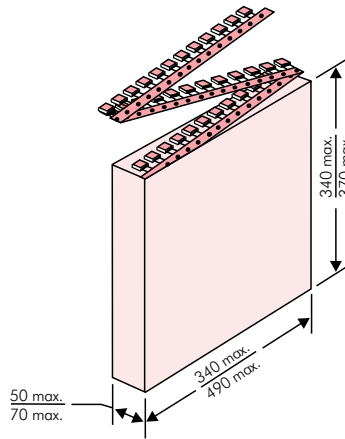

■ REEL Packaging

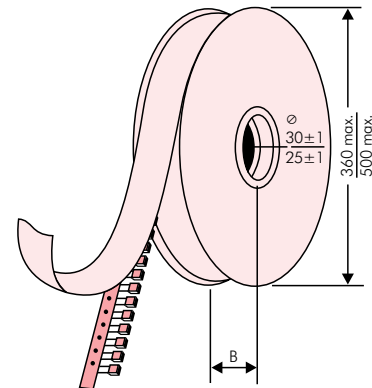

BAR CODE (Labelling)

Labelling of package units in plain text and with alphanumerical Bar Code

Scanner decoding of

- WIMA supplier number
- Customer's P/O number
- Customer's part number
- WIMA confirmation number
- WIMA part number
- Lot number
- Date code
- Quantity

In addition part description of

- article
- capacitance value
- rated voltage
- dimensions
- capacitance tolerance
- packing

as well as gross weight and customer's name are indicated in plain text.

| | | |
|---|---|--------------------------|
| WIMA Best Capacitors Made In Germany | | Werk Unna |
| Supplier-ID: 123456789 | RoHS 2011/65/EU | Date Code: 08.10.10 |
| | | |
| Purchase Order No. (P/O): Bestellung xyz | | Quantity: 5.000 |
| | | |
| Customer Part No.: KUNDETEILENUMMER | | Customer No.: 0000100002 |
| | | Gross Weight [g]: 1870 |
| WIMA Confirmation No.: 0001004053000100 | WIMA Part No.: MKS2C034701C00K8SD | |
| | | |
| Handling Unit: MKS 2 | QTY: 5.000 | COO: DE |
| | MKS 2 0.47 µF 63 VDC 3.5x8.5x7.2 RM5 | |
| 1000067326 | Standard 10% Loss - Standard Dichte 6-2 | Week 03/2011 |
| | Vorlage Debitor Inland | |

BARCODE „Code 39“

Packing Quantities for Capacitors with Radial Pins in PCM 2.5 mm to 22.5 mm



| PCM | Size | | | | bulk | pcs. per packing unit | | | | | | | | | |
|----------------|------|------|-----------|-----------|------|-----------------------|-------|-------|-------|-------|-----------|-----------|------|-----|------|
| | | | | | | ROLL | | REEL | | | | AMMO | | | |
| | W | H | L | Codes | | S | H16.5 | H18.5 | ø 360 | ø 500 | 340 x 340 | 490 x 370 | | | |
| | | | | | N | O | F | I | H | J | A | C | B | D | |
| 2.5 mm | 2.5 | 7 | 4.6 | 0B | 5000 | | 2200 | | 2500 | | - | | 2800 | | - |
| | 3 | 7.5 | 4.6 | 0C | 5000 | | 2000 | | 2300 | | - | | 2300 | | - |
| | 3.8 | 8.5 | 4.6 | 0D | 5000 | | 1500 | | 1800 | | - | | 1800 | | - |
| | 4.6 | 9 | 4.6 | 0E | 5000 | | 1200 | | 1500 | | - | | 1500 | | - |
| | 5.5 | 10 | 4.6 | 0F | 5000 | | 900 | | 1200 | | - | | 1200 | | - |
| 5 mm | 2.5 | 6.5 | 7.2 | 1A | 5000 | | 2200 | | 2500 | | - | | 2800 | | - |
| | 3 | 7.5 | 7.2 | 1B | 5000 | | 2000 | | 2300 | | - | | 2300 | | - |
| | 3.5 | 8.5 | 7.2 | 1C | 5000 | | 1600 | | 2000 | | - | | 2000 | | - |
| | 4.5 | 6 | 7.2 | 1D | 6000 | | 1300 | | 1500 | | - | | 1500 | | - |
| | 4.5 | 9.5 | 7.2 | 1E | 4000 | | 1300 | | 1500 | | - | | 1500 | | - |
| | 5 | 10 | 7.2 | 1F | 3500 | | 1100 | | 1400 | | - | | 1400 | | - |
| | 5.5 | 7 | 7.2 | 1G | 4000 | | 1000 | | 1200 | | - | | 1200 | | - |
| | 5.5 | 11.5 | 7.2 | 1H | 2500 | | 1000 | | 1200 | | - | | 1200 | | - |
| | 6.5 | 8 | 7.2 | 1I | 2500 | | 800 | | 1000 | | - | | 1000 | | - |
| | 7.2 | 8.5 | 7.2 | 1J | 2500 | | 700 | | 1000 | | - | | 1000 | | - |
| | 7.2 | 13 | 7.2 | 1K | 2000 | | 700 | | 950 | | - | | 1000 | | - |
| | 8.5 | 10 | 7.2 | 1L | 2000 | | 600 | | 800 | | - | | 800 | | - |
| 8.5 | 14 | 7.2 | 1M | 1500 | | 600 | | 800 | | - | | 800 | | - | |
| 11 | 16 | 7.2 | 1N | 1000 | | 500 | | 600 | | - | | 400 | | - | |
| 7.5 mm | 2.5 | 7 | 10 | 2A | 5000 | | - | | 2500 | | 4400 | | 2500 | | - |
| | 3 | 8.5 | 10 | 2B | 5000 | | - | | 2200 | | 4300 | | 2300 | | 4150 |
| | 4 | 9 | 10 | 2C | 4000 | | - | | 1700 | | 3200 | | 1700 | | 3100 |
| | 4.5 | 9.5 | 10.3 | 2D | 3500 | | - | | 1500 | | 2900 | | 1400 | | 2700 |
| | 5 | 10.5 | 10.3 | 2E | 3000 | | - | | 1300 | | 2500 | | 1300 | | - |
| | 5.7 | 12.5 | 10.3 | 2F | 2000 | | - | | 1000 | | 2200 | | 1100 | | - |
| | 7.2 | 12.5 | 10.3 | 2G | 1500 | | - | | 900 | | 1800 | | 1000 | | - |
| 10 mm | 3 | 9 | 13 | 3A | 3000 | | - | | 1100 | | 2200 | | - | | 1900 |
| | 4 | 8.5 | 13.5 | FA | 3000 | | - | | 900 | | 1600 | | - | | 1450 |
| | 4 | 9 | 13 | 3C | 3000 | | - | | 900 | | 1600 | | - | | 1450 |
| | 4 | 9.5 | 13 | 3D | 3000 | | - | | 900 | | 1600 | | - | | 1400 |
| | 5 | 10 | 13.5 | FB | 2000 | | - | | 700 | | 1300 | | - | | 1200 |
| | 5 | 11 | 13 | 3F | 3000 | | - | | 700 | | 1300 | | - | | 1200 |
| | 6 | 12 | 13 | 3G | 2400 | | - | | 550 | | 1100 | | - | | 1000 |
| | 6 | 12.5 | 13 | 3H | 2400 | | - | | 550 | | 1100 | | - | | 1000 |
| 8 | 12 | 13 | 3I | 2000 | | - | | 400 | | 800 | | - | | 740 | |
| 15 mm | 5 | 11 | 18 | 4B | 2400 | | - | | 600 | | 1200 | | - | | 1150 |
| | 5 | 13 | 19 | FC | 1000 | | - | | 600 | | 1200 | | - | | 1200 |
| | 6 | 12.5 | 18 | 4C | 2000 | | - | | 500 | | 1000 | | - | | 1000 |
| | 6 | 14 | 19 | FD | 1000 | | - | | 500 | | 1000 | | - | | 1000 |
| | 7 | 14 | 18 | 4D | 1600 | | - | | 450 | | 900 | | - | | 850 |
| | 7 | 15 | 19 | FE | 1000 | | - | | 450 | | 900 | | - | | 850 |
| | 8 | 15 | 18 | 4F | 1200 | | - | | 400 | | 800 | | - | | 740 |
| | 8 | 17 | 19 | FF | 500 | | - | | 400 | | 800 | | - | | 740 |
| | 9 | 14 | 18 | 4H | 1200 | | - | | 350 | | 700 | | - | | 650 |
| | 9 | 16 | 18 | 4J | 900 | | - | | 350 | | 700 | | - | | 650 |
| 10 | 18 | 19 | FG | 500 | | - | | 300 | | 650 | | - | | 590 | |
| 11 | 14 | 18 | 4M | 1000 | | - | | 300 | | 600 | | - | | 540 | |
| 22.5 mm | 5 | 14 | 26.5 | 5A | 1200 | | - | | - | | 800 | | - | | 770 |
| | 6 | 15 | 26.5 | 5B | 1000 | | - | | - | | 700 | | - | | 640 |
| | 7 | 16.5 | 26.5 | 5D | 760 | | - | | - | | 600 | | - | | 550 |
| | 8 | 20 | 28 | FH | 500 | | - | | - | | 500 | | - | | 480 |
| | 8.5 | 18.5 | 26.5 | 5F | 500 | | - | | - | | 480 | | - | | 450 |
| | 10 | 22 | 28 | FI | 570* | | - | | - | | 420 | | - | | 380 |
| | 10.5 | 19 | 26.5 | 5G | 594* | | - | | - | | 400 | | - | | 360 |
| | 10.5 | 20.5 | 26.5 | 5H | 594* | | - | | - | | 400 | | - | | 360 |
| | 11 | 21 | 26.5 | 5I | 561* | | - | | - | | 380 | | - | | 350 |
| 12 | 24 | 28 | FJ | 480* | | - | | - | | 350 | | - | | 310 | |

* TPS (Tray-Packing-System). Plate versions may have different packing units. Samples and pre-production needs on request.

■ Moulded versions.

Rights reserved to amend design data without prior notification.



Packing Quantities for Capacitors with Radial Pins in PCM 27.5 mm to 52.5 mm

| PCM | Size | | | | bulk | pcs. per packing unit | | | | | | | | | | | |
|----------------|------|------|------|-----------|------|-----------------------|---|-------|-------|----------|-------|-------|-----------|-------|-----------|-------|-------|
| | | | | | | ROLL | | REEL | | | | AMMO | | | | | |
| | W | H | L | Codes | | S | N | O | ø 360 | | ø 500 | | 340 x 340 | | 490 x 370 | | |
| | | | | | | | | H16.5 | H18.5 | H16.5 | H18.5 | H16.5 | H18.5 | H16.5 | H18.5 | H16.5 | H18.5 |
| | | | | | | | | F | I | H | J | A | C | B | D | | |
| 27.5 mm | 9 | 19 | 31.5 | 6A | 567* | - | - | - | - | 460/340* | - | - | 420 | | | | |
| | 11 | 21 | 31.5 | 6B | 459* | - | - | - | - | 380/280* | - | - | 350 | | | | |
| | 13 | 24 | 31.5 | 6D | 378* | - | - | - | - | 300 | - | - | 290 | | | | |
| | 13 | 25 | 33 | 6K | 405* | - | - | - | - | - | - | - | - | | | | |
| | 15 | 26 | 31.5 | 6F | 324* | - | - | - | - | 270 | - | - | 250 | | | | |
| | 15 | 26 | 33 | 6L | 324* | - | - | - | - | - | - | - | - | | | | |
| | 17 | 29 | 31.5 | 6G | 198* | - | - | - | - | - | - | - | - | | | | |
| | 17 | 34.5 | 31.5 | 6I | 198* | - | - | - | - | - | - | - | - | | | | |
| | 20 | 32 | 33 | 6M | 162* | - | - | - | - | - | - | - | - | | | | |
| | 20 | 39.5 | 31.5 | 6J | 162* | - | - | - | - | - | - | - | - | | | | |
| 37.5 mm | 9 | 19 | 41.5 | 7A | 441* | - | - | - | - | - | - | - | - | | | | |
| | 11 | 22 | 41.5 | 7B | 357* | - | - | - | - | - | - | - | - | | | | |
| | 13 | 24 | 41.5 | 7C | 294* | - | - | - | - | - | - | - | - | | | | |
| | 15 | 26 | 41.5 | 7D | 252* | - | - | - | - | - | - | - | - | | | | |
| | 17 | 29 | 41.5 | 7E | 154* | - | - | - | - | - | - | - | - | | | | |
| | 19 | 32 | 41.5 | 7F | 140* | - | - | - | - | - | - | - | - | | | | |
| | 20 | 39.5 | 41.5 | 7G | 126* | - | - | - | - | - | - | - | - | | | | |
| | 24 | 45.5 | 41.5 | 7H | 112* | - | - | - | - | - | - | - | - | | | | |
| | 31 | 46 | 41.5 | 7I | 84* | - | - | - | - | - | - | - | - | | | | |
| | 35 | 50 | 41.5 | 7J | 35* | - | - | - | - | - | - | - | - | | | | |
| | 40 | 55 | 41.5 | 7K | 28* | - | - | - | - | - | - | - | - | | | | |
| 48.5 mm | 19 | 31 | 56 | 8D | 120* | - | - | - | - | - | - | - | - | | | | |
| | 23 | 34 | 56 | 8E | 80* | - | - | - | - | - | - | - | - | | | | |
| | 27 | 37.5 | 56 | 8H | 84* | - | - | - | - | - | - | - | - | | | | |
| | 33 | 48 | 56 | 8J | 25* | - | - | - | - | - | - | - | - | | | | |
| | 37 | 54 | 56 | 8L | 25* | - | - | - | - | - | - | - | - | | | | |
| 52.5 mm | 25 | 45 | 57 | 9D | 70* | - | - | - | - | - | - | - | - | | | | |
| | 30 | 45 | 57 | 9E | 60* | - | - | - | - | - | - | - | - | | | | |
| | 35 | 50 | 57 | 9F | 25* | - | - | - | - | - | - | - | - | | | | |
| | 45 | 55 | 57 | 9H | 20* | - | - | - | - | - | - | - | - | | | | |
| | 45 | 65 | 57 | 9J | 20* | - | - | - | - | - | - | - | - | | | | |

* for 2-inch transport pitches.

* TPS (Tray-Packing-System). Plate versions may have different packing units. Samples and pre-production needs on request.

■ Moulded versions.

Rights reserved to amend design data without prior notification.

Updated data on www.wima.com



A WIMA part number consists of 18 digits and is composed as follows:

- Field 1 - 4: Type description
- Field 5 - 6: Rated voltage
- Field 7 - 10: Capacitance
- Field 11 - 12: Size and PCM
- Field 13 - 14: Version code (e.g. Snubber versions)
- Field 15: Capacitance tolerance
- Field 16: Packing
- Field 17 - 18: Pin length (untaped)

| | | | | | | | | | | | | | | | | | |
|----------|----------|----------|----------|----------|----------|----------|----------|----------|-------------|----------|----------|----------|----------|----------|----------|----------|----------|
| 1 | 2 | 3 | 4 | 5 | 6 | 7 | 8 | 9 | 10 | 11 | 12 | 13 | 14 | 15 | 16 | 17 | 18 |
| M | K | S | 2 | C | 0 | 2 | 1 | 0 | 0 | 1 | A | 0 | 0 | M | S | S | D |
| MKS 2 | | | | 63 VDC | | 0.01 µF | | | 2.5x6.5x7.2 | | - | | 20% | bulk | 6 -2 | | |

| | | | | |
|--|--|---|--|---|
| <p>Type description:</p> <p>SMD-PET = SMDT SMD-PEN = SMDN SMD-PPS = SMDI FKP 02 = FKPO MKS 02 = MKS0 FKS 2 = FKS2 FKP 2 = FKP2 FKS 3 = FKS3 FKP 3 = FKP 3 MKS 2 = MKS2 MKP 2 = MKP2 MKS 4 = MKS4 MKP 4C = MKPC MKP 4 = MKP4 MKP 10 = MKP1 FKP 1 = FKP1 MKP-X2 = MKX2 MKP-X1 R = MKX1 MKP-Y2 = MKY2 MP 3-X2 = MPX2 MP 3-X1 = MPX1 MP 3-Y2 = MPY2 MP 3R-Y2 = MPRY MKP 4F = MKPF Snubber MKP = SNMP Snubber FKP = SNFP GTO MKP = GTOM DC-LINK MKP 3 = DCP3 DC-LINK MKP 4 = DCP4 DC-LINK MKP 4S = DCP5 DC-LINK MKP 5 = DCP5 DC-LINK MKP 6 = DCP6 DC-LINK HC = DCHC DC-LINK HY = DCHY</p> | <p>Rated voltage:</p> <p>50 VDC = B0 63 VDC = C0 100 VDC = D0 250 VDC = F0 400 VDC = G0 450 VDC = H0 520 VDC = H2 600 VDC = I0 630 VDC = J0 700 VDC = K0 800 VDC = L0 850 VDC = M0 900 VDC = N0 1000 VDC = O1 1100 VDC = P0 1200 VDC = Q0 1250 VDC = R0 1500 VDC = S0 1600 VDC = T0 2000 VDC = U0 2500 VDC = V0 3000 VDC = W0 4000 VDC = X0 6000 VDC = Y0 250 VAC = 0W 275 VAC = 1W 300 VAC = 2W 305 VAC = AW 350 VAC = BW 440 VAC = 4W 500 VAC = 5W ...</p> | <p>Capacitance:</p> <p>22 pF = 0022 47 pF = 0047 100 pF = 0100 150 pF = 0150 220 pF = 0220 330 pF = 0330 470 pF = 0470 680 pF = 0680 1000 pF = 1100 1500 pF = 1150 2200 pF = 1220 3300 pF = 1330 4700 pF = 1470 6800 pF = 1680 0.01 µF = 2100 0.022 µF = 2220 0.047 µF = 2470 0.1 µF = 3100 0.22 µF = 3220 0.47 µF = 3470 1 µF = 4100 2.2 µF = 4220 4.7 µF = 4470 10 µF = 5100 22 µF = 5220 47 µF = 5470 100 µF = 6100 220 µF = 6220 1000 µF = 7100 1500 µF = 7150 ...</p> | <p>Size:</p> <p>4.8x3.3x3 Size 1812 = KA 4.8x3.3x4 Size 1812 = KB 5.7x5.1x3.5 Size 2220 = QA 5.7x5.1x4.5 Size 2220 = QB 7.2x6.1x3 Size 2824 = TA 7.2x6.1x5 Size 2824 = TB 10.2x7.6x5 Size 4030 = VA 12.7x10.2x6 Size 5040 = XA 15.3x13.7x7 Size 6054 = YA 2.5x7x4.6 PCM 2.5 = 0B 3x7.5x4.6 PCM 2.5 = 0C 2.5x6.5x7.2 PCM 5 = 1A 3x7.5x7.2 PCM 5 = 1B 2.5x7x10 PCM 7.5 = 2A 3x8.5x10 PCM 7.5 = 2B 3x9x13 PCM 10 = 3A 4x9x13 PCM 10 = 3C 5x11x18 PCM 15 = 4B 6x12.5x18 PCM 15 = 4C 5x14x26.5 PCM 22.5 = 5A 6x15x26.5 PCM 22.5 = 5B 9x19x31.5 PCM 27.5 = 6A 11x21x31.5 PCM 27.5 = 6B 9x19x41.5 PCM 37.5 = 7A 11x22x41.5 PCM 37.5 = 7B 19x31x56 PCM 48.5 = 8D 25x45x57 PCM 52.5 = 9D ...</p> <p>Version code:</p> <p>Standard = 00 Version A1 = 1A Version A1.1.1 = 1B Version A2 = 2A ...</p> | <p>Tolerance:</p> <p>±20% = M ±10% = K ±5% = J ±2.5% = H ±1% = E ...</p> <p>Packing:</p> <p>AMMO H16.5 340x340 = A AMMO H16.5 490x370 = B AMMO H18.5 340x340 = C AMMO H18.5 490x370 = D REEL H16.5 360 = F REEL H16.5 500 = H REEL H18.5 360 = I REEL H18.5 500 = J ROLL H16.5 = N ROLL H18.5 = O BLISTER W12 180 = P BLISTER W12 330 = Q BLISTER W16 330 = R BLISTER W24 330 = T Bulk/TPS Standard = S ...</p> <p>Pin length (untaped)</p> <p>3.5 ±0.5 = C9 6 -2 = SD 16 ±1 = P1 ...</p> <p>Pin length (taped)</p> <p>none = 00</p> |
|--|--|---|--|---|

The data on this page is not complete and serves only to explain the part number system. Part number information is listed on the pages of the respective WIMA range.

X-ON Electronics

Largest Supplier of Electrical and Electronic Components

Click to view similar products for [Film Capacitors](#) category:

Click to view products by [WIMA](#) manufacturer:

Other Similar products are found below :

[F339X134748MIP2T0](#) [F450KG153J250ALH0J](#) [750-1018](#) [FKP1-1500160010P15](#) [FKP1R031007D00JYSD](#) [FKP1R031507E00JYSD](#)
[FKP1U024707E00KYSD](#) [82DC4100CK60J](#) [82EC1100DQ50K](#) [PFR5101J100J11L16.5TA18](#) [PME261JB5220KR19T0](#) [A451GK223M040A](#)
[A561ED221M450A](#) [QXJ2E474KTPT](#) [QXL2B333KTPT](#) [R49AN347000A1K](#) [EEC2G505HQA406](#) [B25668A6676A375](#) [B25673A4282E140](#)
[BFC233868148](#) [BFC2370GC222](#) [C3B2AD44400B20K](#) [C4ASWBU3220A3EK](#) [CB027C0473J--](#) [CB177I0184J--](#) [CB182K0184J--](#) [23PW210](#)
[950CQW5H-F](#) [SBDC3470AA10J](#) [SCD105K122A3-22](#) [2N3155](#) [A571EH331M450A](#) [FKP1-2202KV5P15](#) [FKS3-680040010P10](#)
[QXL2E473KTPT](#) [445450-1](#) [B25669A3996J375](#) [46KI322000M1M](#) [46KR415050M1K](#) [4BSNBX4100ZBFJ](#) [MKP383510063JKP2T0](#)
[MKPY2-.02230020P15](#) [MKT 1813-368-015](#) [4055292001](#) [46KN410000N1K](#) [EEC2E106HQA405](#) [EEC2G205HQA402](#) [EEC2G805HQA415](#)
[P409CP224M250AH470](#) [82EC2150DQ50K](#)