

## Metallized Polypropylene (PP) RFI-Capacitors Class X2 in PCM 7.5 mm to 37.5 mm. Capacitances from 1000 pF to 10 µF. Rated Voltage 305 VAC.

### Special Features

- Reliable self-healing
- High degree of interference suppression due to good attenuation and low ESR
- According to RoHS 2011/65/EU

### Typical Applications

Class X2 RFI applications to meet EMC regulations

- Capacitors connected to the mains between phase and neutral or phase conductors
- General requirements, pulse peak voltage  $\leq 2.5$  kV

### Construction

#### Dielectric:

Polypropylene (PP) film

#### Capacitor electrodes:

Vacuum-deposited

#### Internal construction:

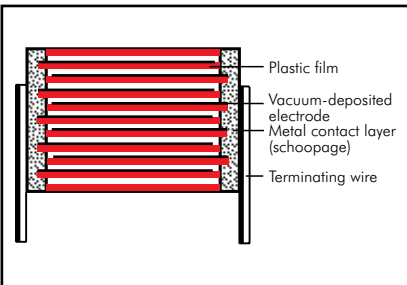

#### Encapsulation:

Solvent-resistant, flame-retardant plastic case with epoxy resin seal, UL 94 V-0

#### Terminations:

Tinned wire.

#### Marking:

Colour: Red. Marking: Black.

### Electrical Data

**Capacitance range:** 1000 pF to 10 µF

**Rated voltage:** 305 VAC

**Continuous DC voltage\*** (general guide):  $\leq 560$  V

**Capacitance tolerances:**  $\pm 20\%$ ,  $\pm 10\%$ ,  $\pm 5\%$

**Operating temperature range:**  $-55^\circ\text{C}$  to  $+105^\circ\text{C}$

#### Climatic test category:

55/105/56 in accordance with IEC

Passive flammability class:

B for capacitors with  $V > 1750$  mm<sup>3</sup>

C for capacitors with  $V \leq 1750$  mm<sup>3</sup>

#### Test specifications:

In accordance with IEC 60384-14

#### Dissipation factors at $+20^\circ\text{C}$ : $\tan \delta$

at f	$C \leq 0.1 \mu\text{F}$	$0.1 \mu\text{F} < C \leq 1.0 \mu\text{F}$	$C > 1.0 \mu\text{F}$
1 kHz	$\leq 15 \times 10^{-4}$	$\leq 20 \times 10^{-4}$	$\leq 30 \times 10^{-4}$
10 kHz	$\leq 20 \times 10^{-4}$	$\leq 60 \times 10^{-4}$	-
100 kHz	$\leq 100 \times 10^{-4}$	-	-

**Insulation resistance** at  $+20^\circ\text{C}$ :

$C \leq 0.33 \mu\text{F}$ :  $\geq 15 \times 10^3 \text{ M}\Omega$

$C > 0.33 \mu\text{F}$ :  $\geq 5000 \text{ sec (M}\Omega \times \mu\text{F)}$

Measuring voltage: 100 V/1 min.

#### Maximum pulse rise time:

100 V/ $\mu\text{sec}$  for pulses equal to a voltage

amplitude with  $\sqrt{2} \times 305 \text{ VAC} = 432 \text{ V}$

according to IEC 60384-14

#### Test voltage:

$C \leq 1.0 \mu\text{F}$ : 2260 VDC, 2 sec.

$C > 1.0 \mu\text{F}$ : 1800 VDC, 2 sec.

#### Reliability:

Operational life  $> 300\,000$  hours

Failure rate  $< 2$  fit ( $0.5 \times U_r$  and  $40^\circ\text{C}$ )

### Approvals:

Country	Authority	Specification	Symbol	Approval-No.
Germany	VDE	IEC 60384-14/4		40003472
USA/Canada	UL	UL 60384-14 CAN/CSA-E60384-14		E 134915

### Mechanical Tests

**Pull test on pins:** 10 N in direction of pins according to IEC 60068-2-21

**Vibration:** 6 hours at 10...2000 Hz and 0.75 mm displacement amplitude or 10 g in accordance with IEC 60068-2-6

**Low air density:** 1kPa = 10 mbar in accordance with IEC 60068-2-13

**Bump test:** 4000 bumps at 390 m/sec<sup>2</sup> in accordance with IEC 60068-2-29

\* If safety-approved EMI suppression capacitors are operated with a DC voltage being above the specified AC voltage rating the given approvals are no longer valid (IEC 60384-14).

Furthermore the permissible pulse rise time  $du/dt$  ( $F_{\text{max}}$ ) will be subject to a reduction according to

$$F_{\text{max}} = F_r \times \sqrt{2} \times \text{UAC} / \text{UDC}$$

if the DC operating voltage UDC is higher than  $\sqrt{2} \times \text{UAC}$

### Packing

Available taped and reeled up to and including case size 15 x 26 x 31.5 / PCM 27.5 mm.

Detailed taping information and graphs at the end of the catalogue.

For further details and graphs please refer to Technical Information.

## Continuation

### General Data

Capacitance	305 VAC*					Part number
	W	H	L	PCM**		
1000 pF	4	9	10	<b>7.5</b>	MKX2AW11002C00_____	
1200 "	4	9	10	<b>7.5</b>	MKX2AW11202C00_____	
1500 "	4	9	10	<b>7.5</b>	MKX2AW11502C00_____	
1800 "	4	9	10	<b>7.5</b>	MKX2AW11802C00_____	
2200 "	4	9	10	<b>7.5</b>	MKX2AW12202C00_____	
2700 "	4	9	10	<b>7.5</b>	MKX2AW12702C00_____	
3300 "	4	9	10	<b>7.5</b>	MKX2AW13302C00_____	
3900 "	4	9	10	<b>7.5</b>	MKX2AW13902C00_____	
4700 "	4	9	10	<b>7.5</b>	MKX2AW14702C00_____	
5600 "	4	9	10	<b>7.5</b>	MKX2AW15602C00_____	
6800 "	4	9	10	<b>7.5</b>	MKX2AW16802C00_____	
8200 "	4	9	10	<b>7.5</b>	MKX2AW18202C00_____	
0.01 µF	4	9	10	<b>7.5</b>	MKX2AW21002C00_____	
	5	11	13	10	MKX2AW21003F00_____	
0.012 "	4	9	10	<b>7.5</b>	MKX2AW21202C00_____	
	5	11	13	10	MKX2AW21203F00_____	
0.015 "	4	9	10	<b>7.5</b>	MKX2AW21502C00_____	
	5	11	13	10	MKX2AW21503F00_____	
0.018 "	4	9	10	<b>7.5</b>	MKX2AW21802C00_____	
	5	11	13	10	MKX2AW21803F00_____	
0.022 "	4	9	10	<b>7.5</b>	MKX2AW22202C00_____	
	5	11	13	10	MKX2AW22203F00_____	
0.027 "	5	10.5	10.3	<b>7.5</b>	MKX2AW22702E00_____	
	5	11	13	10	MKX2AW22703F00_____	
0.033 "	5	10.5	10.3	<b>7.5</b>	MKX2AW23302E00_____	
	5	11	13	10	MKX2AW23303F00_____	
0.039 "	5.7	12.5	10.3	<b>7.5</b>	MKX2AW23902F00_____	
	5	11	13	10	MKX2AW23903F00_____	
0.047 "	5.7	12.5	10.3	<b>7.5</b>	MKX2AW24702F00_____	
	6	12.5	13	10	MKX2AW24703H00_____	
	5	11	18	15	MKX2AW24704B00_____	
0.056 "	6	12.5	13	10	MKX2AW25603H00_____	
	5	11	18	15	MKX2AW25604B00_____	
0.068 "	6	12.5	13	10	MKX2AW26803H00_____	
	5	11	18	15	MKX2AW26804B00_____	
0.082 "	6	12.5	13	10	MKX2AW28203H00_____	
	5	11	18	15	MKX2AW28204B00_____	

\* f = 50/60 Hz

\*\* PCM = Printed circuit module = pin spacing

Dims. in mm.

d = 0.6  $\phi$  if PCM < 15  
d = 0.8  $\phi$  if PCM  $\geq$  15

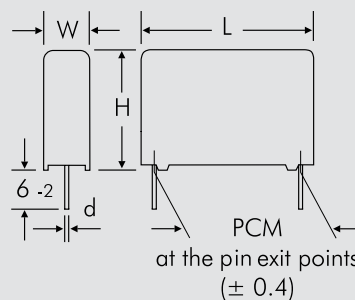

Part number completion:	
Tolerance:	20 % = M
	10 % = K
	5 % = J
Packing:	bulk = S
Pin length:	6-2 = SD
Taped version see page 145.	

Rights reserved to amend design data without prior notification.

## Continuation

### General Data

Capacitance	305 VAC*					Part number
	W	H	L	PCM**		
0.1 $\mu$ F	8	12	13	10	MKX2AW31003I00_____	
	5	11	18	15	MKX2AW31004B00_____	
	6	12.5	18	15	MKX2AW31004C00_____	
0.12 "	6	12.5	18	15	MKX2AW31204C00_____	
	0.15 "	6	12.5	18	15	MKX2AW31504C00_____
0.18 "		8	15	18	15	MKX2AW31504F00_____
	6	15	26.5	22.5	MKX2AW31505B00_____	
	8	15	18	15	MKX2AW31804F00_____	
0.22 "	6	15	26.5	22.5	MKX2AW31805B00_____	
	0.27 "	9	14	18	15	MKX2AW32204H00_____
0.33 "		8	15	18	15	MKX2AW32204F00_____
	6	15	26.5	22.5	MKX2AW32205B00_____	
	8	15	18	15	MKX2AW32704F00_____	
0.39 "	7	16.5	26.5	22.5	MKX2AW32705D00_____	
	0.47 "	11	14	18	15	MKX2AW33304M00_____
		9	16	18	15	MKX2AW33304J00_____
0.56 "	7	16.5	26.5	22.5	MKX2AW33305D00_____	
	8.5	18.5	26.5	22.5	MKX2AW33905F00_____	
	0.68 "	8.5	18.5	26.5	22.5	MKX2AW34705F00_____
10.5		19	26.5	22.5	MKX2AW34705G00_____	
0.82 "	9	19	31.5	27.5	MKX2AW34706A00_____	
	10.5	19	26.5	22.5	MKX2AW35605G00_____	
	9	19	31.5	27.5	MKX2AW35606A00_____	
0.82 "	10.5	19	26.5	22.5	MKX2AW36805G00_____	
	11	21	26.5	22.5	MKX2AW36805I00_____	
	9	19	31.5	27.5	MKX2AW36806A00_____	
0.82 "	11	21	26.5	27.5	MKX2AW38205I00_____	
	9	19	31.5	27.5	MKX2AW38206A00_____	

\* f = 50/60 Hz

\*\* PCM = Printed circuit module = pin spacing

Dims. in mm.

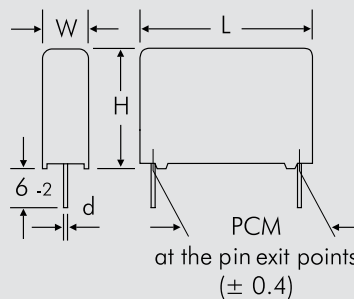

d = 0.6  $\phi$  if PCM = 10  
d = 0.8  $\phi$  if PCM  $\geq$  15

Part number completion:

Tolerance: 20 % = M  
10 % = K  
5 % = J

Packing: bulk = S  
Pin length: 6-2 = SD

Taped version see page 145.

Rights reserved to amend design data without prior notification.

Continuation page 79

## Continuation

### General Data

Capacitance	305 VAC*				PCM**	Part number
	W	H	L			
1.0 $\mu$ F	11	21	26.5	22.5	MKX2AW41005I00_____	
	11	21	31.5	27.5	MKX2AW41006B00_____	
	13	24	31.5	27.5	MKX2AW41006D00_____	
1.2 "	11	21	31.5	27.5	MKX2AW41206B00_____	
	13	24	31.5	27.5	MKX2AW41506D00_____	
1.5 "	15	26	31.5	27.5	MKX2AW41506F00_____	
	13	24	41.5	37.5	MKX2AW41507C00_____	
	13	24	31.5	27.5	MKX2AW41806D00_____	
1.8 "	13	24	41.5	37.5	MKX2AW41807C00_____	
	15	26	31.5	27.5	MKX2AW42206F00_____	
2.2 "	17	29	31.5	27.5	MKX2AW42206G00_____	
	13	24	41.5	37.5	MKX2AW42207C00_____	
	15	26	41.5	37.5	MKX2AW42207D00_____	
2.7 "	17	29	31.5	27.5	MKX2AW42706G00_____	
	15	26	41.5	37.5	MKX2AW42707D00_____	
	17	29	41.5	37.5	MKX2AW42707E00_____	
3.3 "	17	34.5	31.5	27.5	MKX2AW43306I00_____	
	20	39.5	31.5	27.5	MKX2AW43306J00_____	
	15	26	41.5	37.5	MKX2AW43307D00_____	
3.9 "	17	29	41.5	37.5	MKX2AW43307E00_____	
	17	34.5	31.5	27.5	MKX2AW43906I00_____	
	17	29	41.5	37.5	MKX2AW43907E00_____	
4.7 "	19	32	41.5	37.5	MKX2AW43907F00_____	
	20	39.5	31.5	27.5	MKX2AW44706J00_____	
	19	32	41.5	37.5	MKX2AW44707F00_____	
5.6 "	20	39.5	41.5	37.5	MKX2AW44707G00_____	
	19	32	41.5	37.5	MKX2AW45607F00_____	
	20	39.5	41.5	37.5	MKX2AW45607G00_____	
6.8 "	20	39.5	41.5	37.5	MKX2AW46807G00_____	
	24	45.5	41.5	37.5	MKX2AW46807H00_____	
	24	45.5	41.5	37.5	MKX2AW48207H00_____	
8.2 "	24	45.5	41.5	37.5	MKX2AW48207H00_____	
	31	46	41.5	37.5	MKX2AW48207I00_____	
10 $\mu$ F	24	45.5	41.5	37.5	MKX2AW51007H00_____	
	31	46	41.5	37.5	MKX2AW51007I00_____	

\* f = 50/60 Hz

\*\* PCM = Printed circuit module = pin spacing

Dims. in mm.

d = 0.8  $\phi$  if PCM  $\leq$  27.5  
d = 1.0  $\phi$  if PCM = 37.5

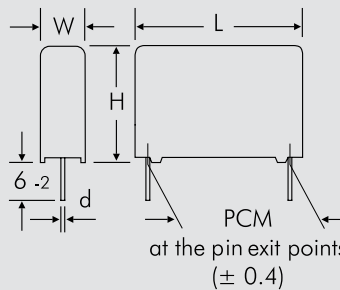

Part number completion:	
Tolerance:	20 % = M
	10 % = K
	5 % = J
Packing:	bulk = S
Pin length:	6-2 = SD
Taped version see page 145.	

Rights reserved to amend design data without prior notification.

## Recommendation for Processing and Application of Through-Hole Capacitors

### Soldering Process

Internal temperature of the capacitor must be kept as follows:

Polyester: preheating:  $T_{max.} \leq 125^{\circ}C$   
soldering:  $T_{max.} \leq 135^{\circ}C$

Polypropylene: preheating:  $T_{max.} \leq 100^{\circ}C$   
soldering:  $T_{max.} \leq 110^{\circ}C$

### Single wave soldering

Soldering bath temperature:  $T < 260^{\circ}C$   
Dwell time:  $t < 5 \text{ sec}$

### Double wave soldering

Soldering bath temperature:  $T < 260^{\circ}C$   
Dwell time:  $\Sigma t < 5 \text{ sec}$

Due to different soldering processes and heat requirements the graphs are to be regarded as a recommendation only.

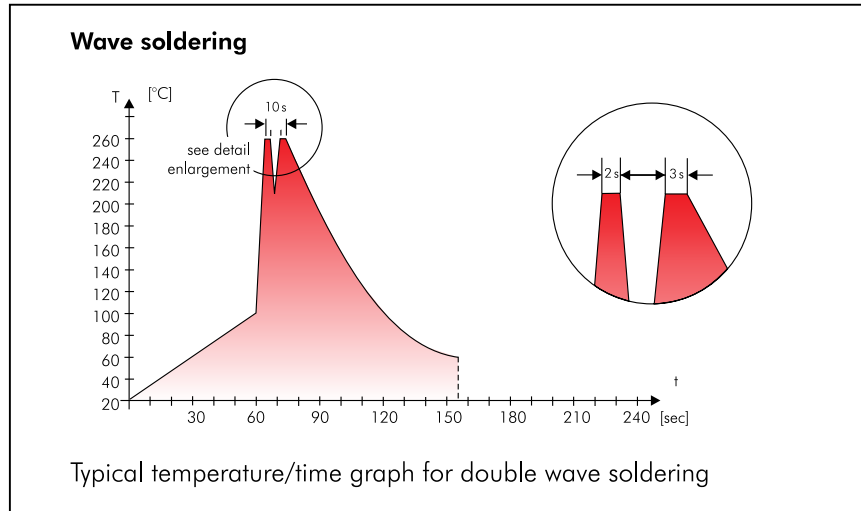

## WIMA Quality and Environmental Philosophy

### ISO 9001:2008 Certification

ISO 9001:2008 is an international basic standard of quality assurance systems for all branches of industry. The approval according to ISO 9001:2008 of our factories by the infaz (Institut für Auditierung und Zertifizierung) certifies that organisation, equipment and monitoring of quality assurance in our factories correspond to internationally recognized standards.

### WIMA WPCS

The WIMA Process Control System (WPCS) is a quality surveillance and optimization system developed by WIMA. WPCS is a major part of the quality-oriented WIMA production. Points of application during production process:

- incoming material inspection
- metallization
- film inspection
- schoopage
- pre-healing
- pin attachment
- cast resin preparation/encapsulation
- 100% final inspection
- Testing as per customer requirements

### WIMA Environmental Policy

All WIMA capacitors, irrespective of whether through-hole devices or SMD, are made of environmentally friendly materials. Neither during manufacture nor in the product itself any toxic substances are used, e.g.

- Lead
- PCB
- CFC
- Hydrocarbon chloride
- Chromium 6+
- PBB/PBDE
- Arsenic
- Cadmium
- Mercury
- etc.

We merely use pure, recyclable materials for packing our components, such as:

- carton
- cardboard
- adhesive tape made of paper
- polystyrene

We almost completely refrain from using packing materials such as:

- foamed polystyrene (Styropor®)
- adhesive tapes made of plastic
- metal clips

### RoHS Compliance

According to the RoHS Directive 2011/65/EU certain hazardous substances like e.g. lead, cadmium, mercury must not be used any longer in electronic equipment as of July 1st, 2006. For the sake of the environment WIMA has refrained from using such substances since years already.



WIMA Kondensatoren sind bleifrei konform RoHS 2011/65/EU

WIMA capacitors are lead free in accordance with RoHS 2011/65/EU

Tape for lead-free WIMA capacitors

### DIN EN ISO 14001:2004

WIMA's environmental management has been established in accordance with the guidelines of DIN EN ISO 14001:2004 to optimize the production processes with regard to energy and resources.

# Typical Dimensions for Taping Configuration

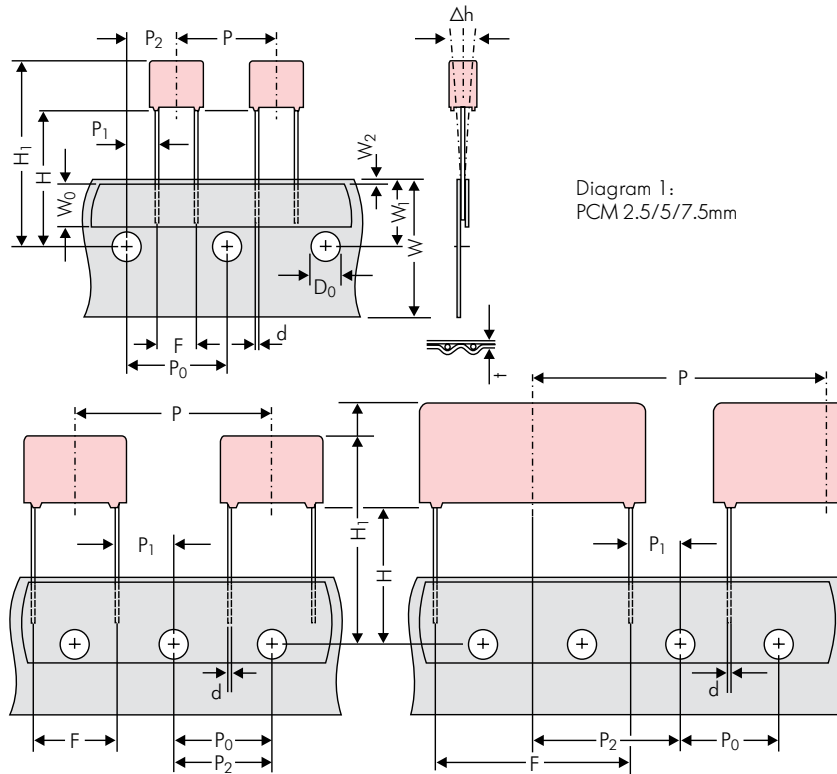

Diagram 1:  
PCM 2.5/5/7.5mm

Diagram 2: PCM 10/15 mm

Diagram 3: PCM 22.5 and 27.5\*mm

\*PCM 27.5 taping possible with two feed holes between components

Designation	Symbol	Dimensions for Radial Taping							
		PCM 2.5 taping	PCM 5 taping	PCM 7.5 taping	PCM 10 taping*	PCM 15 taping*	PCM 22.5 taping	PCM 27.5 taping	
Carrier tape width	W	18.0 ±0.5	18.0 ±0.5	18.0 ±0.5	18.0 ±0.5	18.0 ±0.5	18.0 ±0.5	18.0 ±0.5	
Hold-down tape width	W <sub>0</sub>	6.0 for hot-sealing adhesive tape	6.0 for hot-sealing adhesive tape	12.0 for hot-sealing adhesive tape	12.0 for hot-sealing adhesive tape	12.0 for hot-sealing adhesive tape	12.0 for hot-sealing adhesive tape	12.0 for hot-sealing adhesive tape	
Hole position	W <sub>1</sub>	9.0 ±0.5	9.0 ±0.5	9.0 ±0.5	9.0 ±0.5	9.0 ±0.5	9.0 ±0.5	9.0 ±0.5	
Hold-down tape position	W <sub>2</sub>	0.5 to 3.0 max.	0.5 to 3.0 max.	0.5 to 3.0 max.	0.5 to 3.0 max.	0.5 to 3.0 max.	0.5 to 3.0 max.	0.5 to 3.0 max.	
Feed hole diameter	D <sub>0</sub>	4.0 ±0.2	4.0 ±0.2	4.0 ±0.2	4.0 ±0.2	4.0 ±0.2	4.0 ±0.2	4.0 ±0.2	
Pitch of component	P	12.7 ±1.0	12.7 ±1.0	12.7 ±1.0	25.4 ±1.0	25.4 ±1.0	38.1 ±1.5	38.1 ±1.5 or 50.8 ±1.5	
Feed hole pitch	P <sub>0</sub>	12.7 ±0.3 cumulative pitch error max. 1.0 mm/20 pitch	12.7 ±0.3 cumulative pitch error max. 1.0 mm/20 pitch	12.7 ±0.3 cumulative pitch error max. 1.0 mm/20 pitch	12.7 ±0.3 cumulative pitch error max. 1.0 mm/20 pitch	12.7 ±0.3 cumulative pitch error max. 1.0 mm/20 pitch	12.7 ±0.3 cumulative pitch error max. 1.0 mm/20 pitch	12.7 ±0.3 cumulative pitch error max. 1.0 mm/20 pitch	
Feed hole centre to pin	P <sub>1</sub>	5.1 ±0.5	3.85 ±0.7	2.6 ±0.7	7.7 ±0.7	5.2 ±0.7	7.8 ±0.7	5.3 ±0.7	
Hole centre to component centre	P <sub>2</sub>	6.35 ±1.3	6.35 ±1.3	6.35 ±1.3	12.7 ±1.3	12.7 ±1.3	19.05 ±1.3	19.05 ±1.3	
Feed hole centre to bottom edge of the component	H	16.5 ±0.3 18.5 ±0.5	16.5 ±0.3 18.5 ±0.5	16.5 ±0.5 18.5 ±0.5	16.5 ±0.5 18.5 ±0.5	16.5 ±0.5 18.5 ±0.5	16.5 ±0.5 18.5 ±0.5	16.5 ±0.5 18.5 ±0.5	
Feed hole centre to top edge of the component	H <sub>1</sub>	H+H <sub>component</sub> < H <sub>1</sub> 32.25 max.	H+H <sub>component</sub> < H <sub>1</sub> 32.25 max.	H+H <sub>component</sub> < H <sub>1</sub> 24.5 to 31.5	H+H <sub>component</sub> < H <sub>1</sub> 25.0 to 31.5	H+H <sub>component</sub> < H <sub>1</sub> 26.0 to 37.0	H+H <sub>component</sub> < H <sub>1</sub> 30.0 to 43.0	H+H <sub>component</sub> < H <sub>1</sub> 35.0 to 45.0	
Pin spacing at upper edge of carrier tape	F	2.5 ±0.5	5.0 <sup>+0.8</sup> <sub>-0.2</sub>	7.5 ±0.8	10.0 ±0.8	15 ±0.8	22.5 ±0.8	27.5 ±0.8	
Pin diameter	d	0.4 ±0.05	0.5 ±0.05	0.5 ±0.05 or 0.6 <sup>+0.06</sup> <sub>-0.05</sub>	0.5 ±0.05 or 0.6 <sup>+0.06</sup> <sub>-0.05</sub>	0.8 <sup>+0.08</sup> <sub>-0.05</sub>	0.8 <sup>+0.08</sup> <sub>-0.05</sub>	0.8 <sup>+0.08</sup> <sub>-0.05</sub>	
Component alignment	Δh	± 2.0 max.	± 2.0 max.	± 3.0 max.	± 3.0 max.	± 3.0 max.	± 3.0 max.	± 3.0 max.	
Total tape thickness	t	0.7 ±0.2	0.7 ±0.2	0.7 ±0.2	0.7 ±0.2	0.7 ±0.2	0.7 ±0.2	0.7 ±0.2	
Package (see also page 146)	ROLL/AMMO				AMMO				
	REEL	φ 360 max. φ 30 ±1	B 52 ±2 58 ±2 } depending on comp. dimensions	REEL φ 360 max. φ 30 ±1				B 52 ±2 58 ±2 } depending on PCM and component dimensions	REEL φ 500 max. φ 25 ±1
Unit	see details page 147.								

Dims in mm.

\* Diameter of pins see General Data.

\* PCM 10 and PCM 15 can be crimped to PCM 7.5.

Position of components according to PCM 7.5 (sketch 11). P<sub>0</sub> = 12.7 or 15.0 is possible

Please clarify customer-specific deviations with the manufacturer.

## Types of Tape Packaging of Capacitors for Automatic Radial Insertion

### ■ ROLL Packaging

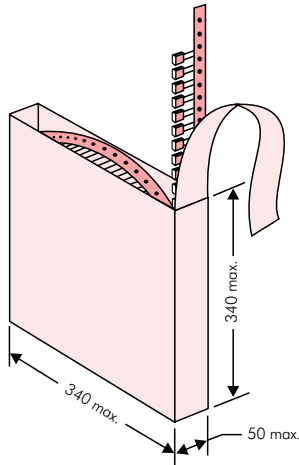

### ■ AMMO Packaging

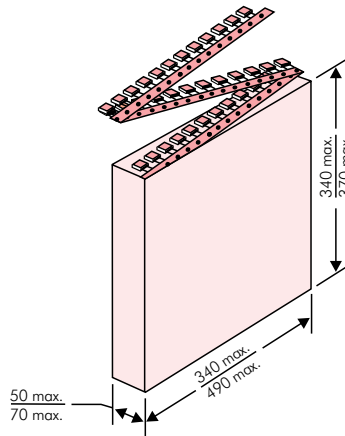

### ■ REEL Packaging

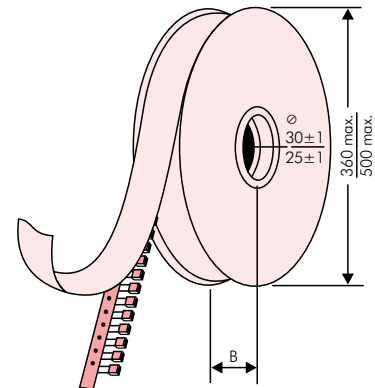

## BAR CODE (Labelling)

Labelling of package units in plain text and with alphanumerical Bar Code

Scanner decoding of

- WIMA supplier number
- Customer's P/O number
- Customer's part number
- WIMA confirmation number
- WIMA part number
- Lot number
- Date code
- Quantity

In addition part description of

- article
- capacitance value
- rated voltage
- dimensions
- capacitance tolerance
- packing

as well as gross weight and customer's name are indicated in plain text.

<b>WIMA</b> Best Capacitors Made In Germany		Werk Unna
Supplier-ID: 123456789	<b>RoHS</b> 2011/65/EU	Date Code: 08.10.10
Purchase Order No. (P/O): Bestellung xyz		Quantity: 5.000
Customer Part No.: KUNDETEILENUMMER		Customer No.: 0000100002
		Gross Weight [g]: 1870
WIMA Confirmation No.: 0001004053000100	WIMA Part No.: MKS2C034701C00K8SD	
Handling Unit: <b>MKS 2</b>	<b>QTY: 5.000</b>	<b>COO: DE</b>
	<b>MKS 2 0.47 µF 63 VDC 3.5x8.5x7.2 RM5</b>	
1000067326	Standard 10% Loss - Standard	Dichte 6-2
- Vorlage Debitor Inland		Week 03/2011

BARCODE „Code 39“

# Packing Quantities for Capacitors with Radial Pins in PCM 2.5 mm to 22.5 mm



PCM	Size				bulk	pcs. per packing unit								
						ROLL		REEL				AMMO		
	W	H	L	Codes		S	H16.5	H18.5	ø 360	ø 500	340 x 340	490 x 370		
					N	O	F	I	H	J	A	C	B	D
<b>2.5 mm</b>	2.5	7	4.6	<b>0B</b>	5000		2200	2500				2800		
	3	7.5	4.6	<b>0C</b>	5000		2000	2300				2300		
	3.8	8.5	4.6	<b>0D</b>	5000		1500	1800				1800		
	4.6	9	4.6	<b>0E</b>	5000		1200	1500				1500		
	5.5	10	4.6	<b>0F</b>	5000		900	1200				1200		
<b>5 mm</b>	2.5	6.5	7.2	<b>1A</b>	5000		2200	2500				2800		
	3	7.5	7.2	<b>1B</b>	5000		2000	2300				2300		
	3.5	8.5	7.2	<b>1C</b>	5000		1600	2000				2000		
	4.5	6	7.2	<b>1D</b>	6000		1300	1500				1500		
	4.5	9.5	7.2	<b>1E</b>	4000		1300	1500				1500		
	5	10	7.2	<b>1F</b>	3500		1100	1400				1400		
	5.5	7	7.2	<b>1G</b>	4000		1000	1200				1200		
	5.5	11.5	7.2	<b>1H</b>	2500		1000	1200				1200		
	6.5	8	7.2	<b>1I</b>	2500		800	1000				1000		
	7.2	8.5	7.2	<b>1J</b>	2500		700	1000				1000		
	7.2	13	7.2	<b>1K</b>	2000		700	950				1000		
	8.5	10	7.2	<b>1L</b>	2000		600	800				800		
	8.5	14	7.2	<b>1M</b>	1500		600	800				800		
11	16	7.2	<b>1N</b>	1000		500	600				400			
<b>7.5 mm</b>	2.5	7	10	<b>2A</b>	5000			2500	4400		2500			
	3	8.5	10	<b>2B</b>	5000			2200	4300		2300		4150	
	4	9	10	<b>2C</b>	4000			1700	3200		1700		3100	
	4.5	9.5	10.3	<b>2D</b>	3500			1500	2900		1400		2700	
	5	10.5	10.3	<b>2E</b>	3000			1300	2500		1300			
	5.7	12.5	10.3	<b>2F</b>	2000			1000	2200		1100			
	7.2	12.5	10.3	<b>2G</b>	1500			900	1800		1000			
<b>10 mm</b>	3	9	13	<b>3A</b>	3000			1100	2200				1900	
	4	8.5	13.5	<b>FA</b>	3000			900	1600				1450	
	4	9	13	<b>3C</b>	3000			900	1600				1450	
	4	9.5	13	<b>3D</b>	3000			900	1600				1400	
	5	10	13.5	<b>FB</b>	2000			700	1300				1200	
	5	11	13	<b>3F</b>	3000			700	1300				1200	
	6	12	13	<b>3G</b>	2400			550	1100				1000	
	6	12.5	13	<b>3H</b>	2400			550	1100				1000	
8	12	13	<b>3I</b>	2000			400	800				740		
<b>15 mm</b>	5	11	18	<b>4B</b>	2400			600	1200				1150	
	5	13	19	<b>FC</b>	1000			600	1200				1200	
	6	12.5	18	<b>4C</b>	2000			500	1000				1000	
	6	14	19	<b>FD</b>	1000			500	1000				1000	
	7	14	18	<b>4D</b>	1600			450	900				850	
	7	15	19	<b>FE</b>	1000			450	900				850	
	8	15	18	<b>4F</b>	1200			400	800				740	
	8	17	19	<b>FF</b>	500			400	800				740	
	9	14	18	<b>4H</b>	1200			350	700				650	
	9	16	18	<b>4J</b>	900			350	700				650	
	10	18	19	<b>FG</b>	500			300	650				590	
11	14	18	<b>4M</b>	1000			300	600				540		
<b>22.5 mm</b>	5	14	26.5	<b>5A</b>	1200				800				770	
	6	15	26.5	<b>5B</b>	1000				700				640	
	7	16.5	26.5	<b>5D</b>	760				600				550	
	8	20	28	<b>FH</b>	500				500				480	
	8.5	18.5	26.5	<b>5F</b>	500				480				450	
	10	22	28	<b>FI</b>	570*				420				380	
	10.5	19	26.5	<b>5G</b>	594*				400				360	
	10.5	20.5	26.5	<b>5H</b>	594*				400				360	
	11	21	26.5	<b>5I</b>	561*				380				350	
	12	24	28	<b>FJ</b>	480*				350				310	

\* TPS (Tray-Packing-System). Plate versions may have different packing units. Samples and pre-production needs on request.

■ Moulded versions.

Rights reserved to amend design data without prior notification.





## Packing Quantities for Capacitors with Radial Pins in PCM 27.5 mm to 52.5 mm

PCM	Size				bulk	pcs. per packing unit											
						ROLL		REEL				AMMO					
	W	H	L	Codes		S	N	O	ø 360		ø 500		340 x 340		490 x 370		
								H16.5	H18.5	H16.5	H18.5	H16.5	H18.5	H16.5	H18.5	H16.5	H18.5
								F	I	H	J	A	C	B	D		
<b>27.5 mm</b>	9	19	31.5	<b>6A</b>	567*	-	-	-	-	460/340*	-	-	420				
	11	21	31.5	<b>6B</b>	459*	-	-	-	-	380/280*	-	-	350				
	13	24	31.5	<b>6D</b>	378*	-	-	-	-	300	-	-	290				
	13	25	33	<b>6K</b>	405*	-	-	-	-	-	-	-	-				
	15	26	31.5	<b>6F</b>	324*	-	-	-	-	270	-	-	250				
	15	26	33	<b>6L</b>	324*	-	-	-	-	-	-	-	-				
	17	29	31.5	<b>6G</b>	198*	-	-	-	-	-	-	-	-				
	17	34.5	31.5	<b>6I</b>	198*	-	-	-	-	-	-	-	-				
	20	32	33	<b>6M</b>	162*	-	-	-	-	-	-	-	-				
	20	39.5	31.5	<b>6J</b>	162*	-	-	-	-	-	-	-	-				
<b>37.5 mm</b>	9	19	41.5	<b>7A</b>	441*	-	-	-	-	-	-	-	-				
	11	22	41.5	<b>7B</b>	357*	-	-	-	-	-	-	-	-				
	13	24	41.5	<b>7C</b>	294*	-	-	-	-	-	-	-	-				
	15	26	41.5	<b>7D</b>	252*	-	-	-	-	-	-	-	-				
	17	29	41.5	<b>7E</b>	154*	-	-	-	-	-	-	-	-				
	19	32	41.5	<b>7F</b>	140*	-	-	-	-	-	-	-	-				
	20	39.5	41.5	<b>7G</b>	126*	-	-	-	-	-	-	-	-				
	24	45.5	41.5	<b>7H</b>	112*	-	-	-	-	-	-	-	-				
	31	46	41.5	<b>7I</b>	84*	-	-	-	-	-	-	-	-				
	35	50	41.5	<b>7J</b>	35*	-	-	-	-	-	-	-	-				
	40	55	41.5	<b>7K</b>	28*	-	-	-	-	-	-	-	-				
<b>48.5 mm</b>	19	31	56	<b>8D</b>	120*	-	-	-	-	-	-	-	-				
	23	34	56	<b>8E</b>	80*	-	-	-	-	-	-	-	-				
	27	37.5	56	<b>8H</b>	84*	-	-	-	-	-	-	-	-				
	33	48	56	<b>8J</b>	25*	-	-	-	-	-	-	-	-				
	37	54	56	<b>8L</b>	25*	-	-	-	-	-	-	-	-				
<b>52.5 mm</b>	25	45	57	<b>9D</b>	70*	-	-	-	-	-	-	-	-				
	30	45	57	<b>9E</b>	60*	-	-	-	-	-	-	-	-				
	35	50	57	<b>9F</b>	25*	-	-	-	-	-	-	-	-				
	45	55	57	<b>9H</b>	20*	-	-	-	-	-	-	-	-				
	45	65	57	<b>9J</b>	20*	-	-	-	-	-	-	-	-				

\* for 2-inch transport pitches.

\* TPS (Tray-Packing-System). Plate versions may have different packing units. Samples and pre-production needs on request.

■ Moulded versions. Rights reserved to amend design data without prior notification.

Updated data on [www.wima.com](http://www.wima.com)



A WIMA part number consists of 18 digits and is composed as follows:

- Field 1 - 4: Type description
- Field 5 - 6: Rated voltage
- Field 7 - 10: Capacitance
- Field 11 - 12: Size and PCM
- Field 13 - 14: Version code (e.g. Snubber versions)
- Field 15: Capacitance tolerance
- Field 16: Packing
- Field 17 - 18: Pin length (untaped)

1	2	3	4	5	6	7	8	9	10	11	12	13	14	15	16	17	18
<b>M</b>	<b>K</b>	<b>S</b>	<b>2</b>	<b>C</b>	<b>0</b>	<b>2</b>	<b>1</b>	<b>0</b>	<b>0</b>	<b>1</b>	<b>A</b>	<b>0</b>	<b>0</b>	<b>M</b>	<b>S</b>	<b>S</b>	<b>D</b>
MKS 2				63 VDC		0.01 µF			2.5x6.5x7.2		-		20%	bulk	6 -2		

<p><b>Type description:</b></p> <p>SMD-PET = SMDT                  SMD-PEN = SMDN                  SMD-PPS = SMDI                  FKP 02 = FKPO                  MKS 02 = MKS0                  FKS 2 = FKS2                  FKP 2 = FKP2                  FKS 3 = FKS3                  FKP 3 = FKP 3                  MKS 2 = MKS2                  MKP 2 = MKP2                  MKS 4 = MKS4                  MKP 4C = MKPC                  MKP 4 = MKP4                  MKP 10 = MKP1                  FKP 1 = FKP1                  MKP-X2 = MKX2                  MKP-X1 R = MKX1                  MKP-Y2 = MKY2                  MP 3-X2 = MPX2                  MP 3-X1 = MPX1                  MP 3-Y2 = MPY2                  MP 3R-Y2 = MPRY                  MKP 4F = MKPF                  Snubber MKP = SNMP                  Snubber FKP = SNFP                  GTO MKP = GTOM                  DC-LINK MKP 3 = DCP3                  DC-LINK MKP 4 = DCP4                  DC-LINK MKP 4S = DCP5                  DC-LINK MKP 5 = DCP5                  DC-LINK MKP 6 = DCP6                  DC-LINK HC = DCHC                  DC-LINK HY = DCHY</p>	<p><b>Rated voltage:</b></p> <p>50 VDC = B0                  63 VDC = C0                  100 VDC = D0                  250 VDC = F0                  400 VDC = G0                  450 VDC = H0                  520 VDC = H2                  600 VDC = I0                  630 VDC = J0                  700 VDC = K0                  800 VDC = L0                  850 VDC = M0                  900 VDC = N0                  1000 VDC = O1                  1100 VDC = P0                  1200 VDC = Q0                  1250 VDC = R0                  1500 VDC = S0                  1600 VDC = T0                  2000 VDC = U0                  2500 VDC = V0                  3000 VDC = W0                  4000 VDC = X0                  6000 VDC = Y0                  250 VAC = 0W                  275 VAC = 1W                  300 VAC = 2W                  305 VAC = AW                  350 VAC = BW                  440 VAC = 4W                  500 VAC = 5W                  ...</p>	<p><b>Capacitance:</b></p> <p>22 pF = 0022                  47 pF = 0047                  100 pF = 0100                  150 pF = 0150                  220 pF = 0220                  330 pF = 0330                  470 pF = 0470                  680 pF = 0680                  1000 pF = 1100                  1500 pF = 1150                  2200 pF = 1220                  3300 pF = 1330                  4700 pF = 1470                  6800 pF = 1680                  0.01 µF = 2100                  0.022 µF = 2220                  0.047 µF = 2470                  0.1 µF = 3100                  0.22 µF = 3220                  0.47 µF = 3470                  1 µF = 4100                  2.2 µF = 4220                  4.7 µF = 4470                  10 µF = 5100                  22 µF = 5220                  47 µF = 5470                  100 µF = 6100                  220 µF = 6220                  1000 µF = 7100                  1500 µF = 7150                  ...</p>	<p><b>Size:</b></p> <p>4.8x3.3x3 Size 1812 = KA                  4.8x3.3x4 Size 1812 = KB                  5.7x5.1x3.5 Size 2220 = QA                  5.7x5.1x4.5 Size 2220 = QB                  7.2x6.1x3 Size 2824 = TA                  7.2x6.1x5 Size 2824 = TB                  10.2x7.6x5 Size 4030 = VA                  12.7x10.2x6 Size 5040 = XA                  15.3x13.7x7 Size 6054 = YA                  2.5x7x4.6 PCM 2.5 = 0B                  3x7.5x4.6 PCM 2.5 = 0C                  2.5x6.5x7.2 PCM 5 = 1A                  3x7.5x7.2 PCM 5 = 1B                  2.5x7x10 PCM 7.5 = 2A                  3x8.5x10 PCM 7.5 = 2B                  3x9x13 PCM 10 = 3A                  4x9x13 PCM 10 = 3C                  5x11x18 PCM 15 = 4B                  6x12.5x18 PCM 15 = 4C                  5x14x26.5 PCM 22.5 = 5A                  6x15x26.5 PCM 22.5 = 5B                  9x19x31.5 PCM 27.5 = 6A                  11x21x31.5 PCM 27.5 = 6B                  9x19x41.5 PCM 37.5 = 7A                  11x22x41.5 PCM 37.5 = 7B                  19x31x56 PCM 48.5 = 8D                  25x45x57 PCM 52.5 = 9D                  ...</p> <p><b>Version code:</b></p> <p>Standard = 00                  Version A1 = 1A                  Version A1.1.1 = 1B                  Version A2 = 2A                  ...</p>	<p><b>Tolerance:</b></p> <p>±20% = M                  ±10% = K                  ±5% = J                  ±2.5% = H                  ±1% = E                  ...</p> <p><b>Packing:</b></p> <p>AMMO H16.5 340x340 = A                  AMMO H16.5 490x370 = B                  AMMO H18.5 340x340 = C                  AMMO H18.5 490x370 = D                  REEL H16.5 360 = F                  REEL H16.5 500 = H                  REEL H18.5 360 = I                  REEL H18.5 500 = J                  ROLL H16.5 = N                  ROLL H18.5 = O                  BLISTER W12 180 = P                  BLISTER W12 330 = Q                  BLISTER W16 330 = R                  BLISTER W24 330 = T                  Bulk/TPS Standard = S                  ...</p> <p><b>Pin length (untaped)</b></p> <p>3.5 ±0.5 = C9                  6 -2 = SD                  16 ±1 = P1                  ...</p> <p><b>Pin length (taped)</b></p> <p>none = 00</p>
--	--	---	--	---

The data on this page is not complete and serves only to explain the part number system. Part number information is listed on the pages of the respective WIMA range.

## X-ON Electronics

Largest Supplier of Electrical and Electronic Components

*Click to view similar products for [Film Capacitors](#) category:*

*Click to view products by [WIMA](#) manufacturer:*

Other Similar products are found below :

[F339X134748MIP2T0](#) [F450KG153J250ALH0J](#) [750-1018](#) [FKP1-1500160010P15](#) [FKP1R031007D00JYSD](#) [FKP1R031507E00JYSD](#)  
[FKP1U024707E00KYSD](#) [82DC4100CK60J](#) [82EC1100DQ50K](#) [PFR5101J100J11L16.5TA18](#) [PME261JB5220KR19T0](#) [A451GK223M040A](#)  
[A561ED221M450A](#) [QXJ2E474KTPT](#) [QXL2B333KTPT](#) [R49AN347000A1K](#) [EEC2G505HQA406](#) [B25668A6676A375](#) [B25673A4282E140](#)  
[BFC233868148](#) [BFC2370GC222](#) [C3B2AD44400B20K](#) [C4ASWBU3220A3EK](#) [CB027C0473J--](#) [CB177I0184J--](#) [CB182K0184J--](#) [23PW210](#)  
[950CQW5H-F](#) [SBDC3470AA10J](#) [SCD105K122A3-22](#) [2N3155](#) [A571EH331M450A](#) [FKP1-2202KV5P15](#) [FKS3-680040010P10](#)  
[QXL2E473KTPT](#) [445450-1](#) [B25669A3996J375](#) [46KI322000M1M](#) [46KR415050M1K](#) [4BSNBX4100ZBFJ](#) [MKP383510063JKP2T0](#)  
[MKPY2-.02230020P15](#) [MKT 1813-368-015](#) [4055292001](#) [46KN410000N1K](#) [EEC2E106HQA405](#) [EEC2G205HQA402](#) [EEC2G805HQA415](#)  
[P409CP224M250AH470](#) [82EC2150DQ50K](#)