

SKKT 92, SKKH 92, SKKT 92B



SEMIPACK® 1

Thyristor / Diode Modules

SKKT 92

SKKT 92B

SKKH 92

Features

- Heat transfer through aluminium oxide ceramic isolated metal baseplate
- Hard soldered joints for high reliability
- UL recognized, file no. E 63 532

Typical Applications*

- DC motor control (e. g. for machine tools)
- AC motor soft starters
- Temperature control (e. g. for ovens, chemical processes)
- Professional light dimming (studios, theaters)

1) See the assembly instructions

V_{RSM} V	V_{RRM}, V_{DRM} V	$I_{TRMS} = 150$ A (maximum value for continuous operation)		
		$I_{TAV} = 95$ A (sin. 180; $T_c = 85$ °C)		
900	800	SKKT 92/08E	SKKT 92B08E	SKKH 92/08E
1300	1200	SKKT 92/12E	SKKT 92B12E	SKKH 92/12E
1500	1400	SKKT 92/14E	SKKT 92B14E	SKKH 92/14E
1700	1600	SKKT 92/16E	SKKT 92B16E	SKKH 92/16E
1900	1800	SKKT 92/18E	SKKT 92B18E	SKKH 92/18E

Symbol	Conditions	Values	Units
I_{TAV}	sin. 180; $T_c = 85$ (100) °C;	95 (68)	A
I_D	P3/180; $T_a = 45$ °C; B2 / B6	70 / 85	A
	P3/180F; $T_a = 35$ °C; B2 / B6	140 / 175	A
I_{RMS}	P3/180F; $T_a = 35$ °C; W1 / W3	190 / 3 * 135	A
I_{TSM}	$T_{vj} = 25$ °C; 10 ms	2000	A
	$T_{vj} = 125$ °C; 10 ms	1750	A
i^2t	$T_{vj} = 25$ °C; 8,3 ... 10 ms	20000	A ² s
	$T_{vj} = 125$ °C; 8,3 ... 10 ms	15000	A ² s
V_T	$T_{vj} = 25$ °C; $I_T = 300$ A	max. 1,65	V
$V_{T(TO)}$	$T_{vj} = 125$ °C	max. 0,9	V
r_T	$T_{vj} = 125$ °C	max. 2	mΩ
$I_{DD}; I_{RD}$	$T_{vj} = 125$ °C; $V_{RD} = V_{RRM}; V_{DD} = V_{DRM}$	max. 20	mA
t_{gd}	$T_{vj} = 25$ °C; $I_G = 1$ A; $di_G/dt = 1$ A/μs	1	μs
t_{gr}	$V_D = 0,67 * V_{DRM}$	2	μs
$(di/dt)_{cr}$	$T_{vj} = 125$ °C	max. 150	A/μs
$(dv/dt)_{cr}$	$T_{vj} = 125$ °C	max. 1000	V/μs
t_q	$T_{vj} = 125$ °C	100	μs
I_H	$T_{vj} = 25$ °C; typ. / max.	150 / 250	mA
I_L	$T_{vj} = 25$ °C; $R_G = 33$ Ω; typ. / max.	300 / 600	mA
V_{GT}	$T_{vj} = 25$ °C; d.c.	min. 3	V
I_{GT}	$T_{vj} = 25$ °C; d.c.	min. 150	mA
V_{GD}	$T_{vj} = 125$ °C; d.c.	max. 0,25	V
I_{GD}	$T_{vj} = 125$ °C; d.c.	max. 6	mA
$R_{th(j-c)}$	cont.; per thyristor / per module	0,28 / 0,14	K/W
$R_{th(j-c)}$	sin. 180; per thyristor / per module	0,3 / 0,15	K/W
$R_{th(j-c)}$	rec. 120; per thyristor / per module	0,32 / 0,16	K/W
$R_{th(c-s)}$	per thyristor / per module	0,2 / 0,1	K/W
T_{vj}		- 40 ... + 125	°C
T_{stg}		- 40 ... + 125	°C
V_{isol}	a. c. 50 Hz; r.m.s.; 1 s / 1 min.	3600 / 3000	V~
M_s	to heatsink	5 ± 15 % ¹⁾	Nm
M_t	to terminals	3 ± 15 %	Nm
a		5 * 9,81	m/s ²
m	approx.	95	g
Case	SKKT	A 46	
	SKKT ...B	A 48	
	SKKH	A 47	



SKKT

SKKH

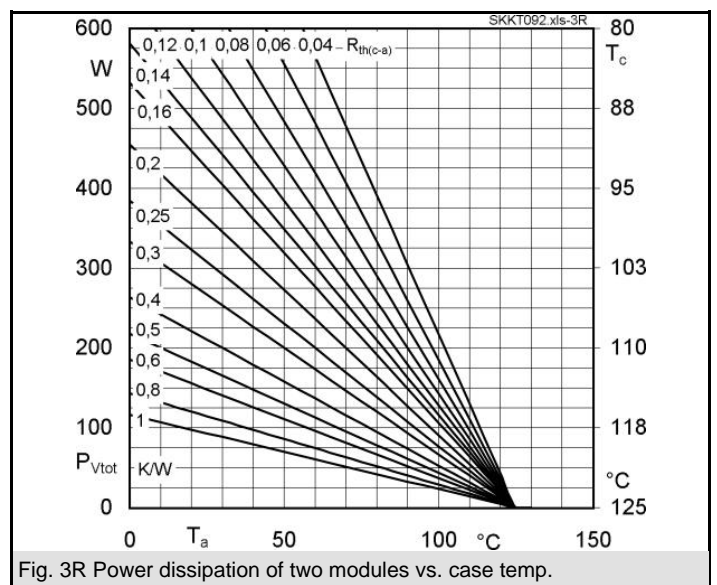
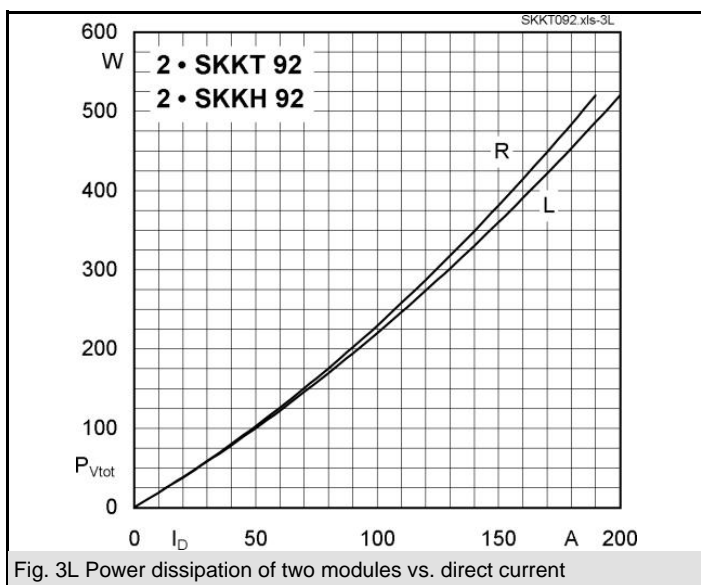
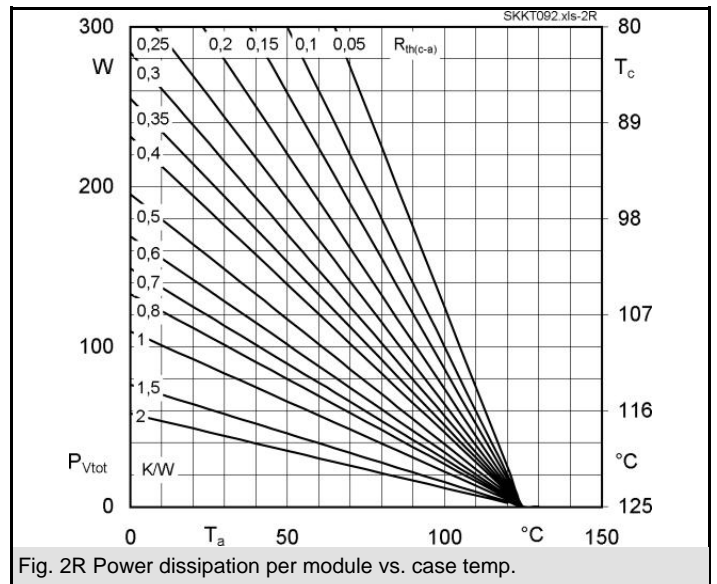
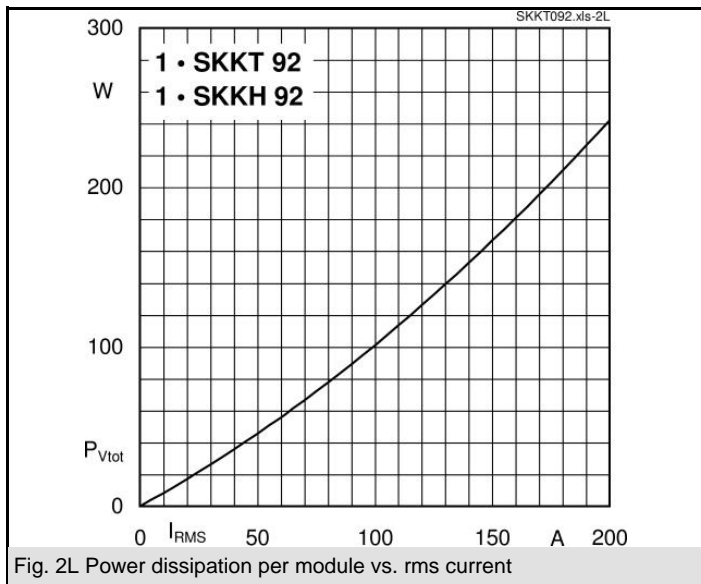
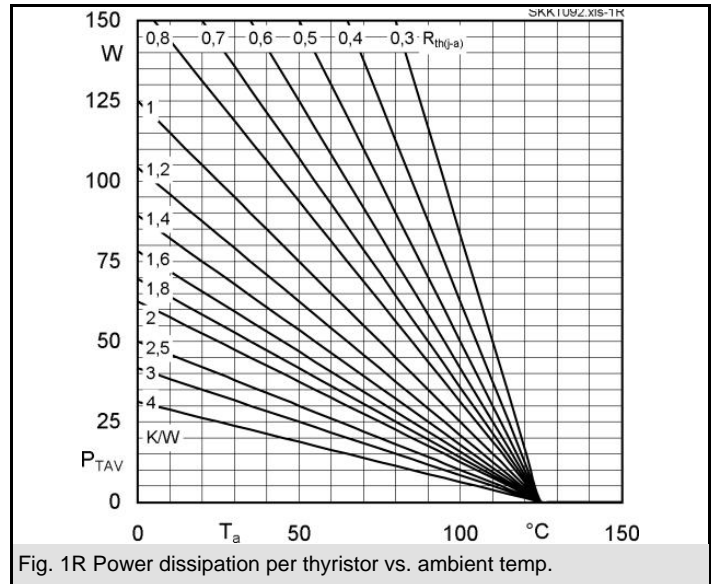
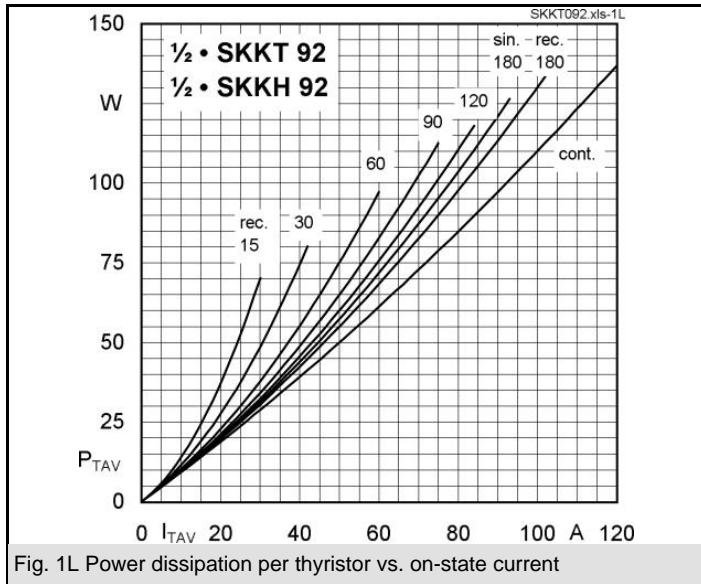

SKKT 92, SKKH 92, SKKT 92B

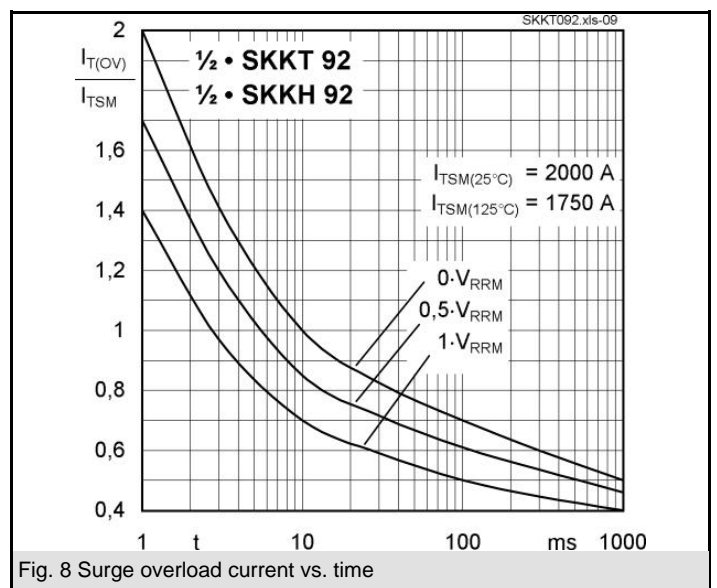
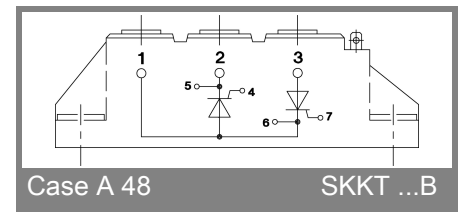
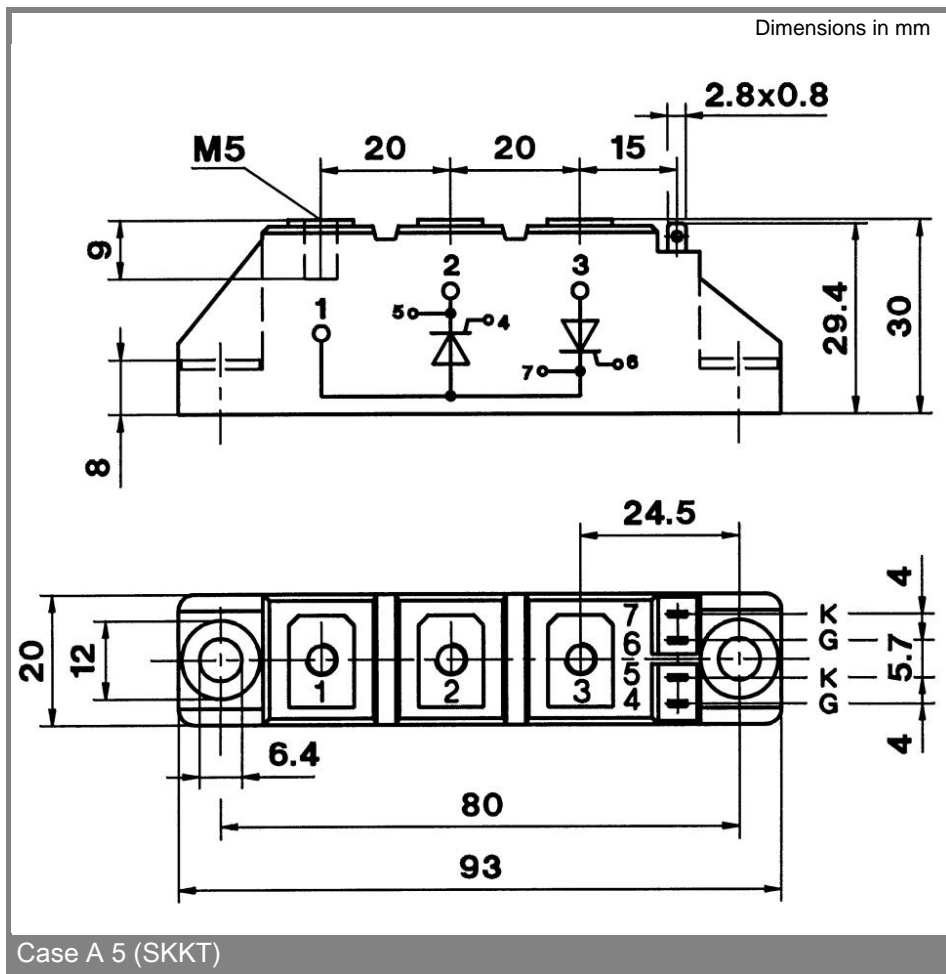



Fig. 9 Gate trigger characteristics



* The specifications of our components may not be considered as an assurance of component characteristics. Components have to be tested for the respective application. Adjustments may be necessary. The use of SEMIKRON products in life support appliances and systems is subject to prior specification and written approval by SEMIKRON. We therefore strongly recommend prior consultation of our personal.

X-ON Electronics

Largest Supplier of Electrical and Electronic Components

Click to view similar products for Thyristor Surge Protection Devices (TSPD) category:

Click to view products by Semikron manufacturer:

Other Similar products are found below :

[MHC-150-16](#) [MHC-170-16](#) [MHC-260-16](#) [MHC-300-16](#) [MHC-500-18](#) [SKKH 57/16E](#) [SKKH 72/08E](#) [SK20NHMH10](#) [P2600SDLRP](#) [SKKH](#)
[162/18E](#) [SKKH 27/12E](#) [SKKH 280/20E H4](#) [SKKH 72/20E H4](#) [TD210N16KOF](#) [TD400N26KOF](#) [TD570N16KOFHPSA2](#) [SKKH92/16E](#)
[SKKH 92/18E](#) [SKKH 172/16E](#) [SKKH 106/16E](#) [TISP4A250H3BJR-S](#) [TISP4A270H3BJR-S](#) [TISP4350J3BJR-S](#) [TISP4200H3BJR-S](#)
[TISP4240L3AJR-S](#) [TISP7082F3DR-S](#) [B1101UALTP](#) [P1804UCMCLTP](#) [T10A240](#) [P0080S4BLRP](#) [P0080SB](#) [P0300EALRP1](#)
[P3100Q12BLRP](#) [P2300Q22CLRP](#) [P0640SCLRP-N1](#) [P0720SALRP](#) [P0720SCMCLRP](#) [P0900SCLRP](#) [P0900SCMCLRP](#) [A2106UC6LRP](#)
[P1104UCLRP](#) [P1100EALRP1](#) [P1100SALRP](#) [P1100SBLRP](#) [P1100SCLRP](#) [P1100SCMCLRP](#) [P1300SALRP](#) [P1300SBLRP](#) [P1300SCMCLRP](#)
[P1301CB2LRP](#)