

### FEATURES

- HIGH K DIELECTRIC
- HIGH CAPACITANCE DENSITY, HIGH CV VALUES AVAILABLE
- LOW ESL, LOW ESR AND EXCELLENT FREQUENCY RESPONSE
- NICKEL BARRIER TERMINATIONS AND EXCELLENT MECHANICAL STRENGTH
- EIA MARKING AVAILABLE

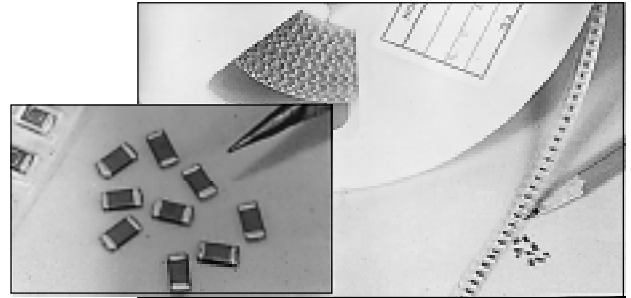

### SPECIFICATIONS Z5U

Capacitance Range	0.01 $\mu$ F to 4.7 $\mu$ F
Capacitance Tolerances	$\pm 20\%$ (M), $+80\%$ - $20\%$ (Z)
Operating Temperature Range	+10°C to +85°C
Temperature Characteristics	+22% to -56% Max. Within Operating Temperature
Rated Voltages	16Vdc, 25Vdc, 50Vdc
Dissipation Factor	4% max. @ 1kHz, 0.5Vrms, +25°C
Insulation Resistance (+25°C, Rated Voltage)	10,000 Megohm or 1000 ohms/F, whichever is less (min.)
Dielectric Withstanding Voltage	150% of Rated Voltage for 1 to 5 seconds, 50 Milliamps Maximum
Test Conditions (EIA-198-2E)	1kHz, 1.0V $\pm 0.2$ Vrms

Typical Z5U Frequency Effects

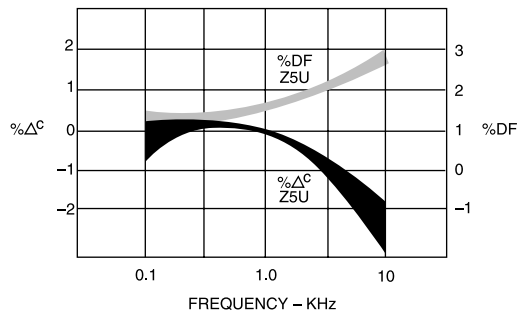

Typical Z5U Temperature Coefficient

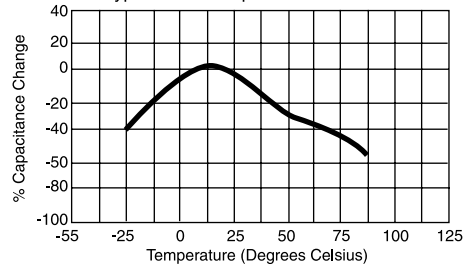

Typical Z5U Aging Characteristic

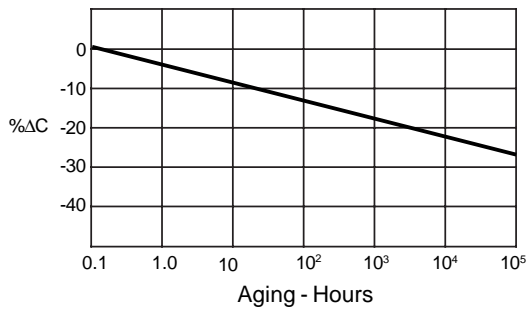

Typical Z5U DF over Temperature

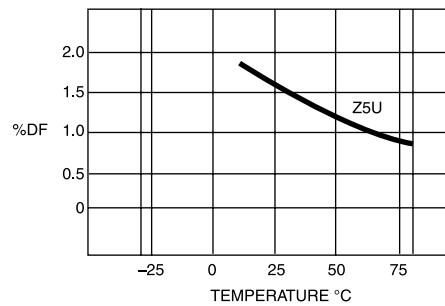

### PART NUMBERING SYSTEM

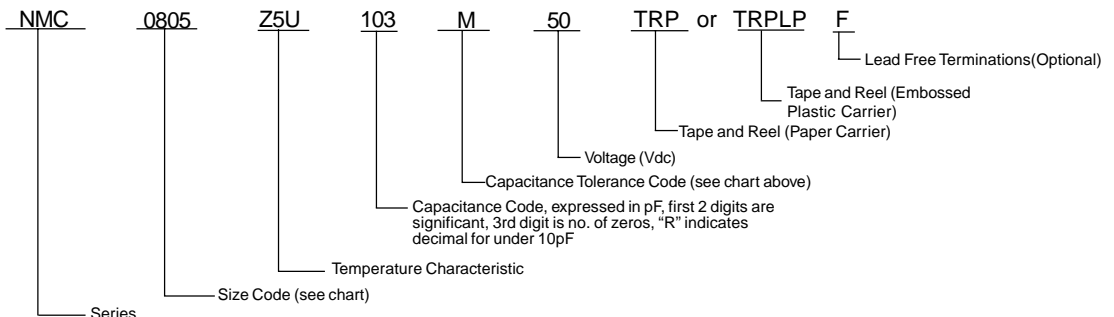

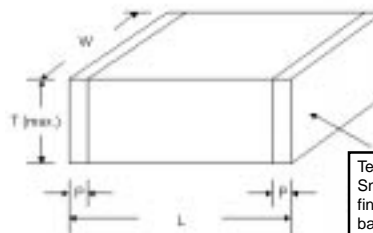

Termination:  
Sn-Pb solder plate  
finish over nickel  
barrier over Pd-Ag  
base. Also available  
with Sn lead free  
plating finish.

### Z5U CAPACITOR SIZE CHART (mm)

(CONSULT FACTORY  
FOR CAPACITANCE  
VALUES NOT LISTED)

EIA Case Size	0402	0603	0805	1206	1210	1812	2225													
Length L	1.0±0.05	1.6±0.15	2.0±0.2	3.2±0.2	3.2±0.2	4.5±0.3	5.7±0.4													
Width W	0.5±0.05	0.8±0.15	1.25±0.2	1.6±0.2	2.5±0.2	3.2±0.25	6.35±0.25													
Thickness (max.) T	0.6	1.0	1.30	1.80	1.80	1.80	*													
Termination Width P	0.2±0.1	.12-.51	.25-.71	.25-.71	.25-.71	.25-.76	.25-1.02													
Capacitance	Working Voltage (Vdc)																			
	16	25	50	25	50	16	25	50	16	25	50	16	25	50	16	25	50			
.001µF				Available in X7R	Available in X7R	Available in X7R														
.0015																				
.0018																				
.0022																				
.0027																				
.0033																				
.0047																				
.0056																				
.0068																				
.0082																				
.01																				
.015																				
.018																				
.022																				
.027																				
.033																				
.047																				
.068																				
.1																				
.15																				
.22																				
.27																				
.33																				
.47																				
.68																				
1.0																	*			
1.5																*	*			
2.2																*	*			
3.3																*	*			
4.7																*	*			

\*Contact NIC for availability and thickness

**1210 SIZE:**

4.7µF / 25Vdc (T = 2.5mm), 6.8µF / 16Vdc (T = 1.8mm), 10µF / 16Vdc (T = 2.2mm)

Special Thickness parts are available. Contact NIC for details.



## X-ON Electronics

Largest Supplier of Electrical and Electronic Components

*Click to view similar products for [nic manufacturer](#):*

Other Similar products are found below :

[NMC0603NPO0R6B50TRPF](#) [NMC0603NPO270J100TRPF](#) [NMC1206X5R226K6.3TRPLP2KF](#) [NRE-S100M25V4X7F](#) [NRE-  
HS102M25V12.5X16F](#) [NRC-S06F2212TRF](#) [NCD180J1KVNPOJTRF](#) [NRC-S06F1692TRF](#) [NMC-P1206X7R104K100TRPF](#) [NMC-  
H1206NPO471K1KVTRPLPF](#) [NML04J9N1TRF](#) [NRSNA4I4J150TR40KF](#) [NCC0805F261HTRF](#) [NRWA470M35V6.3X11TBF](#)  
[NACE221M16V6.3X8TR13F](#) [NRSS332M50V18X35.5F](#) [NDTM106K25F1TRF](#) [NCM15X7R103K50F](#) [NCD103M1KVZ5UF](#)  
[NRSS682M25V18X35.5F](#) [NEXC224Z5.5V10.5X8.5TRF](#) [NRLRW221M450V30X35SF](#) [NDTM225K50F2TRF](#) [NRSZ471M50V12.5X20F](#)  
[NTCL106K35TRDF](#) [NRWA331M25V10X12.5F](#) [NRSY472M25V16X31.5F](#) [NEXS105Z5.5V28.5X14F](#) [NRLR181M400V25X30SF](#)  
[NRSZ102M25V12.5X20F](#) [NUVA33T385TRF](#) [NUVA33V405TRF](#) [NRLMW331M250V30X25F](#) [NRLF103M25V35X20F](#)  
[NRLMW682M50V30X40F](#) [NDTM106K35F](#) [NRLMW102M200V35X35F](#) [NPIS43LS220MTRF](#) [NDTM476K35F2F](#) [NTC-T475K50TRDF](#)  
[NCD222M1KVZ5UKF](#) [NRLR472M63V25X40SF](#) [NTP157M10TRD\(40\)F](#) [NPIM74C3R3MTRF](#) [NPI104C100MTRF](#)  
[NRLM102M100V25X25F](#) [NACZ331M35V10X10.5TR13F](#) [NRLM223M50V 35X50F](#) [NAZT221M50V10X10.5LBF](#) [NACK102M10V  
10X10.5TR13F](#)