



inserts:		page
CD	64 poles + ⊕	45
CT, CTS (10A)	64 poles + ⊕	51
CDD	108 poles + ⊕	58
CQE	46 poles + ⊕	77
CN	24 poles + ⊕	83
CCE	24 poles + ⊕	92
CNE, CSE	24 poles + ⊕	93
CSS	24 poles + ⊕	101
CTE, CTSE (16A)	24 poles + ⊕	109
CMSE	10+2 (aux) poles + ⊕	118
CMCE	10+2 (aux) poles + ⊕	118
CX	4/8 poles + ⊕	133
MIXO	6 modules	137÷151

insert centre distance:
104 x 27 mm

bulkhead mounting housings with 2 levers or 4 pegs



bulkhead mounting housings with single lever



description	part No.	part No.
with one or two levers	CHI 24	CHI 24 L
with pegs ¹⁾	CHI 24 C	
with pegs and aluminium cover ¹⁾	CHI 24 CS	
with pegs and plastic cover ¹⁾	CHI 24 CP	
with lever and cover		CHI 24 LS

¹⁾ May be combined with hoods:
- CHO/CAO 24 X and CHV/CAV 24 X
- MHO/MAO 24 X and MHV/MAV 24 X

N.B.: the enclosures ensure IP66 protection (or IP65 cover versions) rating when mated and locked with the closing levers.
The cover (CS, CP) only ensures mechanical protection, but does not ensure IP65 protection rating.

panel cut-out for bulkhead mounting housings in mm

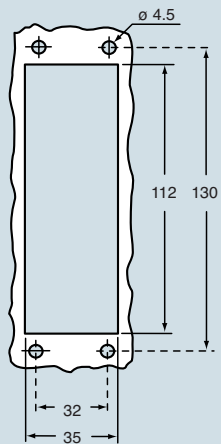

dimensions in mm

CHI

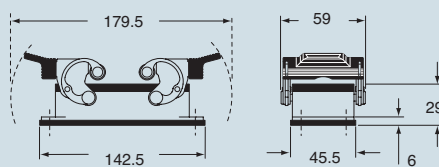

CHI C

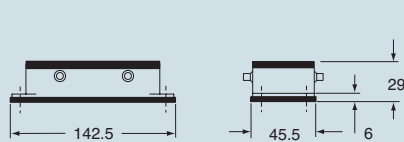

CHI CS/CP

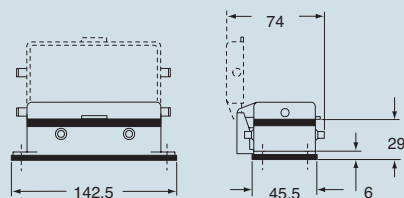

dimensions in mm

CHI L

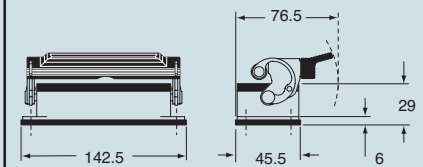

CHI LS

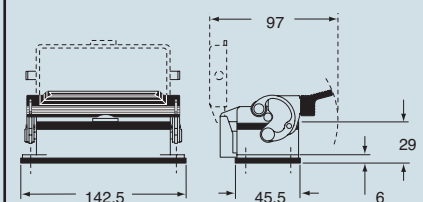

CAVUS® Type 4/4X/12

(excluding enclosures with plastic cover)

dimensions indicated are not binding and may be changed without notice

size 104.27



inserts:		page
CD	64 poles + ⊕	45
CDD	108 poles + ⊕	58
CQE	46 poles + ⊕	77
CN	24 poles + ⊕	83
CCE	24 poles + ⊕	92
CNE, CSE.....	24 poles + ⊕	93
CSS	24 poles + ⊕	101
CMSE	10+2 (aux) poles + ⊕	118
CMCE	10+2 (aux) poles + ⊕	118
CX	4/8 poles + ⊕	133
MIXO	6 modules	137÷151

insert centre distance:
104 x 27 mm

surface mounting housings with 2 levers or 4 pegs



surface mounting housings with single lever



description	part No.	entry Pg	part No.	entry M	part No.	entry Pg	part No.	entry M
with levers	CHP 24	21	MHP 24.25	25	CHP 24 L	21	MHP 24 L25	25
with levers	CHP 24.2	21 x 2	MHP 24.225	25 x 2	CHP 24 L2	21 x 2	MHP 24 L225	25 x 2
with levers, high construction	CAP 24.21	21	MAP 24.32	32	CAP 24 L	21	MAP 24 L32	32
with levers, high construction	CAP 24.221	21 x 2	MAP 24.232	32 x 2	CAP 24 L2	21 x 2	MAP 24 L232	32 x 2
with levers, high construction	CAP 24.29	29	MAP 24.40	40	CAP 24 L29	29	MAP 24 L40	40
with levers, high construction	CAP 24.229	29 x 2	MAP 24.240	40 x 2	CAP 24 L229	29 x 2	MAP 24 L240	40 x 2
with pegs and aluminium cover ¹⁾	CHP 24 CS	21	MHP 24 CS25	25				
with pegs and aluminium cover ¹⁾	CHP 24 CS2	21 x 2	MHP 24 CS225	25 x 2				
with pegs and aluminium cover, high construction ¹⁾	CAP 24 CS	21	MAP 24 CS32	32				
with pegs and aluminium cover, high construction ¹⁾	CAP 24 CS2	21 x 2	MAP 24 CS232	32 x 2				
with pegs and aluminium cover, high construction ¹⁾	CAP 24 CS29	29	MAP 24 CS40	40				
with pegs and aluminium cover, high construction ¹⁾	CAP 24 CS229	29 x 2	MAP 24 CS240	40 x 2				
with pegs and plastic cover ¹⁾	CHP 24 CP	21	MHP 24 CP25	25				
with pegs and plastic cover ¹⁾	CHP 24 CP2	21 x 2	MHP 24 CP225	25 x 2				
with pegs and plastic cover, high construction ¹⁾	CAP 24 CP	21	MAP 24 CP32	32				
with pegs and plastic cover, high construction ¹⁾	CAP 24 CP2	21 x 2	MAP 24 CP232	32 x 2				
with pegs and plastic cover, high construction ¹⁾	CAP 24 CP29	29	MAP 24 CP40	40				
with pegs and plastic cover, high construction ¹⁾	CAP 24 CP229	29 x 2	MAP 24 CP240	40 x 2				
with lever and cover					CHP 24 LS	21	MHP 24 LS25	25
with lever and cover					CHP 24 LS2	21 x 2	MHP 24 LS225	25 x 2
with lever and cover, high construction					CAP 24 LS	21	MAP 24 LS32	32
with lever and cover, high construction					CAP 24 LS2	21 x 2	MAP 24 LS232	32 x 2
with lever and cover, high construction					CAP 24 LS29	29	MAP 24 LS40	40
with lever and cover, high construction					CAP 24 LS229	29 x 2	MAP 24 LS240	40 x 2

¹⁾ May be combined with hoods:
- CHO/CAO 24 X and CHV/CAV 24 X
- MHO/MAO 24 X and MHV/MAV 24 X

N.B.: the enclosures ensure IP66 protection (or IP65 cover versions) rating when mated and locked with the closing levers.
The cover (CS, CP) only ensures mechanical protection, but does not ensure IP65 protection rating.

dimensions in mm

CHP - CAP and MHP - MAP

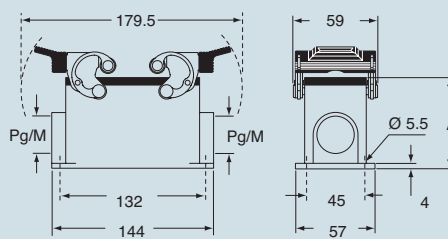

CHP CS/CP - CAP CS/CP and MHP CS/CP - MAP CS/CP

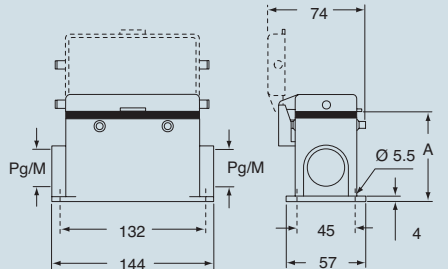

type	A
CHP / MHP	63
CAP / MAP	81
CHP CS / MHP CS	63
CAP CS / MAP CS	81
CHP CP / MHP CP	63
CAP CP / MAP CP	81

dimensions in mm

CHP L - CAP L and MHP L - MAP L

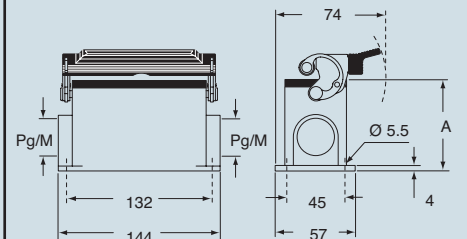

CHP LS - CAP LS and MHP LS - MAP LS

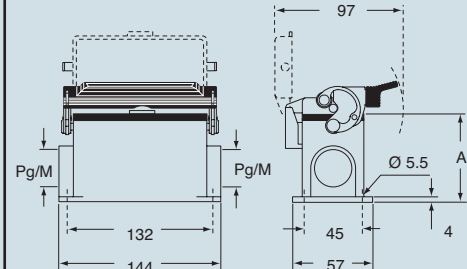

type	A
CHP L / MHP L	63
CAP L / MAP L	81
CHP LS / MHP LS	63
CAP LS / MAP LS	81

CALUS® Type 4/4X/12

(excluding enclosures with plastic cover)

dimensions indicated are not binding and may be changed without notice



inserts:		page
CD	64 poles + ⊕	45
CDD	108 poles + ⊕	58
CQE	46 poles + ⊕	77
CN	24 poles + ⊕	83
CCE	24 poles + ⊕	92
CNE, CSE.....	24 poles + ⊕	93
CSS	24 poles + ⊕	101
CMSE	10+2 (aux) poles + ⊕	118
CMCE	10+2 (aux) poles + ⊕	118
CX	4/8 poles + ⊕	133
MIXO	6 modules	137+151

insert centre distance:
104 x 27 mm

hoods with 4 pegs



hoods with 2 pegs



description	part No.		entry		part No.		entry	
			Pg	M			Pg	M
with pegs, side entry	CHO 24		21		MHO 24.25		25	
with pegs, side entry					MHO 24.32		32	
with pegs, side entry, high construction	CAO 24.21		21		MAO 24.32		32	
with pegs, side entry, high construction	CAO 24.29		29		MAO 24.40		40	
with pegs, top entry	CHV 24		21		MHV 24.25 **		25	
with pegs, top entry					MHV 24.32		32	
with pegs, top entry	CHV 24.29		29		MHV 24.40		40	
with pegs, top entry, high construction	CAV 24.21		21		MAV 24.32		32	
with pegs, top entry, high construction	CAV 24.29		29		MAV 24.40		40	
with pegs, frontal entry, high construction	CAF 24.21		21		MAF 24.25		25	
with pegs, frontal entry, high construction	CAF 24.29		29		MAF 24.32		32	
with pegs, frontal entry, high construction, without adaptor *	CFF 24.21		21		MFF 24.25		25	
with pegs, frontal entry, high construction, without adaptor *	CFF 24.29		29		MFF 24.32		32	

* enclosure without adaptor, threaded on the body, to be used only with a complete cable clamp.

** can only be used with a complete cable clamp (to be purchased separately)

dimensions in mm

CHO (CAO) and MHO (MAO)

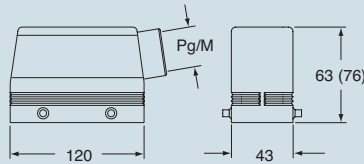

dimensions in mm

CHO L (CAO L) and MHO L (MAO L)

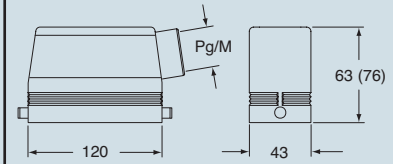

CHV (CAV) and MHV (MAV)

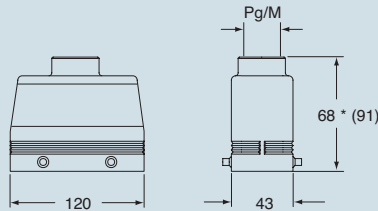

* 69.5 for Pg 29 - M 40 versions

CHV L (CAV L) and MHV L (MAV L)

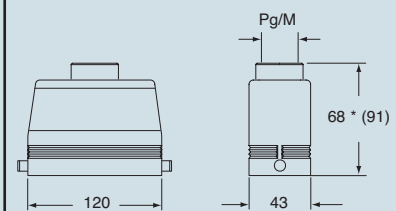

* 69.5 for Pg 29 - M 40 versions

CAF/CFF and MAF/MFF

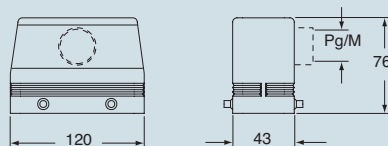

CALUS® Type 4/4X/12

dimensions indicated are not binding and may be changed without notice

size 104.27



inserts:		page
CD	64 poles + ⊕	45
CDD	108 poles + ⊕	58
CQE	46 poles + ⊕	77
CN	24 poles + ⊕	83
CCE	24 poles + ⊕	92
CNE, CSE.....	24 poles + ⊕	93
CSS	24 poles + ⊕	101
CMSE	10+2 (aux) poles + ⊕	118
CMCE	10+2 (aux) poles + ⊕	118
CX	4/8 poles + ⊕	133
MIXO	6 modules	137÷151

insert centre distance:
104 x 27 mm

hoods with 2 levers



hoods with single lever



description	part No.		part No.		part No.		part No.	
		entry Pg		entry M		entry Pg		entry M
with levers and gasket, top entry	CHV 24 G	21	MHV 24 G32	32	CHV 24 LG	21	MHV 24 LG32	32
with levers and gasket, top entry, high construction	CAV 24 G	21	MAV 24 G25	25	CAV 24 LG21	21	MAV 24 LG25	25
with levers and gasket, top entry, high construction	CAV 24 G29	29	MAV 24 G32	32	CAV 24 LG29	29	MAV 24 LG32	32
with levers and gasket, top entry, high constr., without adaptor *	CFV 24 G	21	MFV 24 G25	25	CFV 24 LG21	21	MFV 24 LG25	25
with levers and gasket, top entry, high constr., without adaptor *	CFV 24 G29	29	MFV 24 G32	32	CFV 24 LG29	29	MFV 24 LG32	32

* enclosure without adaptor, threaded on the body, to be used only with a complete cable clamp.

dimensions in mm

**CHV G (CAV G) and [CFV G],
MHV G (MAV G) and [MFV G]**

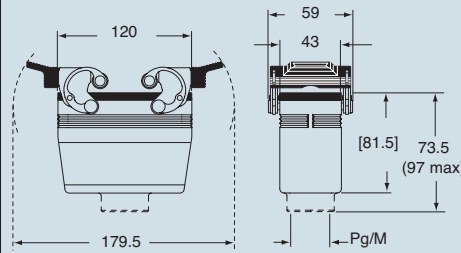

dimensions in mm

**CHV LG (CAV LG) and [CFV LG],
MHV LG (MAV LG) and [MFV LG]**

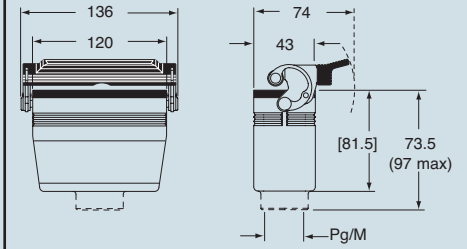

dimensions indicated are not binding and may be changed without notice

size 104.27



inserts:	page
CD 64 poles + ⊕	45
CDD 108 poles + ⊕	58
CQE 46 poles + ⊕	77
CN 24 poles + ⊕	83
CCE 24 poles + ⊕	92
CNE, CSE 24 poles + ⊕	93
CSS 24 poles + ⊕	101
CMSE 10+2 (aux) poles + ⊕	118
CMCE 10+2 (aux) poles + ⊕	118
CX 4/8 poles + ⊕	133
MIXO 6 modules	137÷151

insert centre distance: 104 x 27 mm

The covers for C, G and LG, versions cannot be used together with coding pins. If this application is required, please contact ILME SpA.

hoods with two levers



covers

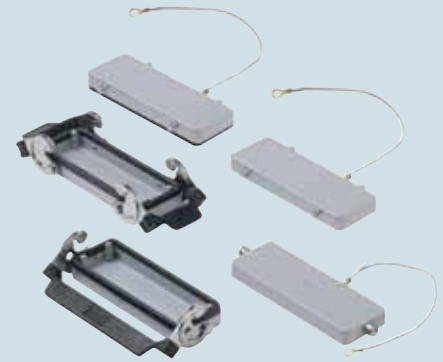

description	part No.	entry Pg	part No.	entry M	part No.
with levers, side entry ¹⁾	CHO 24 X	21	MHO 24 X25	25	
with levers, side entry ¹⁾			MHO 24 X32	32	
with levers, side entry, high construction ¹⁾	CAO 24 X	21	MAO 24 X32	32	
with levers, side entry, high construction ¹⁾	CAO 24 X29	29	MAO 24 X40	40	
with levers, top entry ¹⁾	CHV 24 X	21	MHV 24 X25	25	
with levers, top entry ¹⁾			MHV 24 X32	32	
with levers, top entry, high construction ¹⁾	CAV 24 X	21	MAV 24 X32	32	
with levers, top entry, high construction ¹⁾	CAV 24 X29	29	MAV 24 X40	40	
with 4 pegs (for enclosures with 2 levers with gasket)					CHC 24
with 4 pegs and gasket (for enclosures with 2 levers) ²⁾					CHC 24 C
with 2 pegs (for enclosures with 1 lever with gasket)					CHC 24 L
with 2 levers (for hoods with 4 pegs)					CHC 24 G
with 1 lever (for hoods with 2 pegs)					CHC 24 LG

¹⁾ May be combined with housings:
 - CHI/CHP/CAP 24 CS/CP/C
 - MHP/MAP 24 CS/CP

²⁾ May be combined with hoods:
 - CHO/CAO 24 X and CHV/CAV 24 X
 - MHO/MAO 24 X and MHV/MAV 24 X

dimensions in mm

CHO X (CAO X) and MHO X (MAO X)

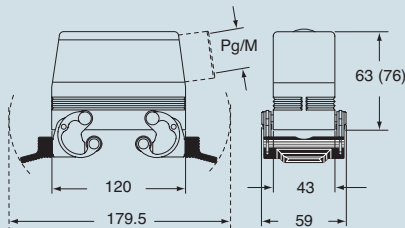

CHV X (CAV X) and MHV X (MAV X)

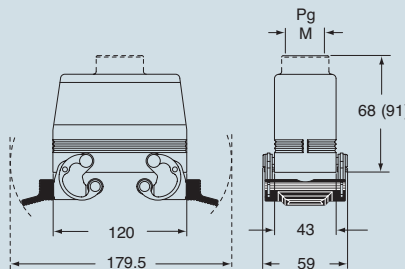

dimensions in mm

CHC



CHC C



CHC L

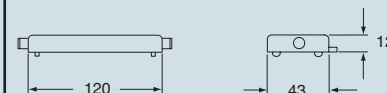

CHC G

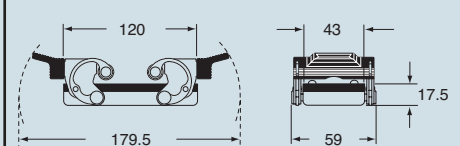

CHC LG

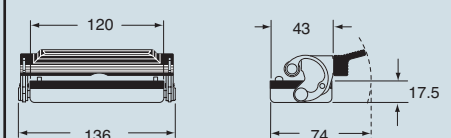

CALUS® Type 4/4X/12

dimensions indicated are not binding and may be changed without notice

size 104.27



inserts:		page
CME	10 + 2 (aux) poles + ⊕	119
CME, CMCE	16 + 2 (aux) poles + ⊕	124

insert centre distance:
104 x 27 mm

bulkhead mounting housings with 2 levers or 4 pegs



bulkhead mounting housings with single lever



description	part No.	part No.
with one or two levers	CMI 16	CMI 16 L
with pegs and aluminium cover ¹⁾	CMI 16 CS	
with pegs and plastic cover ¹⁾	CMI 16 CP	
with lever and cover		CMI 16 LS

¹⁾ May be combined with hoods:
- CMO/CMAO 16 X and CMV/CMAV 16 X
- MMO/MMAO 16 X and MMV/MMAV 16 X

N.B.: the enclosures ensure IP66 protection (or IP65 cover versions) rating when mated and locked with the closing levers.
The cover (CS, CP) only ensures mechanical protection, but does not ensure IP65 protection rating.

panel cut-out for bulkhead mounting housings in mm

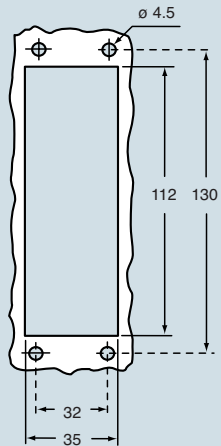

dimensions in mm

CMI

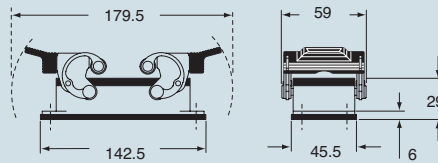

dimensions in mm

CMI L

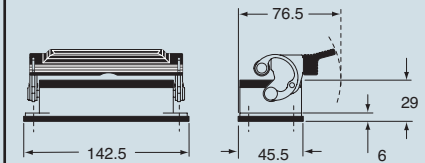

CMI CS/CP

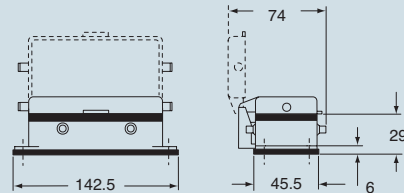

CMI LS

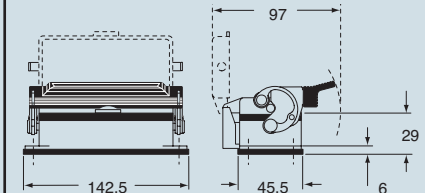

CAUS® Type 4/4X/12
(excluding enclosures with plastic cover)

dimensions indicated are not binding and may be changed without notice

size 104.27



inserts:	page
CME 10 + 2 (aux) poles + ⊕	119
CME, CMCE 16 + 2 (aux) poles + ⊕	124

insert centre distance:
104 x 27 mm

surface mounting housings with 2 levers or 4 pegs



surface mounting housings with single lever



description	part No.	entry Pg	part No.	entry M	part No.	entry Pg	part No.	entry M
with levers	CMP 16	21	MMP 16.25	25	CMP 16 L	21	MMP 16 L25	25
with levers	CMP 16.2	21 x 2	MMP 16.225	25 x 2	CMP 16 L2	21 x 2	MMP 16 L225	25 x 2
with levers, high construction	CMAP 16.21	21	MMAP 16.32	32	CMAP 16 L	21	MMAP 16 L32	32
with levers, high construction	CMAP 16.221	21 x 2	MMAP 16.232	32 x 2	CMAP 16 L2	21 x 2	MMAP 16 L232	32 x 2
with levers, high construction	CMAP 16.29	29	MMAP 16.40	40	CMAP 16 L29	29	MMAP 16 L40	40
with levers, high construction	CMAP 16.229	29 x 2	MMAP 16.240	40 x 2	CMAP 16 L229	29 x 2	MMAP 16 L240	40 x 2
with pegs and aluminium cover ¹⁾	CMP 16 CS	21	MMP 16 CS25	25				
with pegs and aluminium cover ¹⁾	CMP 16 CS2	21 x 2	MMP 16 CS225	25 x 2				
with pegs and aluminium cover, high construction ¹⁾	CMAP 16 CS	21	MMAP 16 CS32	32				
with pegs and aluminium cover, high construction ¹⁾	CMAP 16 CS2	21 x 2	MMAP 16CS232	32 x 2				
with pegs and aluminium cover, high construction ¹⁾	CMAP 16 CS29	29	MMAP 16 CS40	40				
with pegs and aluminium cover, high construction ¹⁾	CMAP 16CS229	29 x 2	MMAP 16CS240	40 x 2				
with pegs and plastic cover ¹⁾	CMP 16 CP	21	MMP 16 CP25	25				
with pegs and plastic cover ¹⁾	CMP 16 CP2	21 x 2	MMP 16 CP225	25 x 2				
with pegs and plastic cover, high construction ¹⁾	CMAP 16 CP	21	MMAP 16 CP32	32				
with pegs and plastic cover, high construction ¹⁾	CMAP 16 CP2	21 x 2	MMAP 16CP232	32 x 2				
with pegs and plastic cover, high construction ¹⁾	CMAP 16 CP29	29	MMAP 16 CP40	40				
with pegs and plastic cover, high construction ¹⁾	CMAP 16CP229	29 x 2	MMAP 16CP240	40 x 2				
with lever and cover					CMP 16 LS	21	MMP 16 LS25	25
with lever and cover					CMP 16 LS2	21 x 2	MMP 16 LS225	25 x 2
with lever and cover, high construction					CMAP 16 LS	21	MMAP 16 LS32	32
with lever and cover, high construction					CMAP 16 LS2	21 x 2	MMAP 16LS232	32 x 2
with lever and cover, high construction					CMAP 16 LS29	29	MMAP 16 LS40	40
with lever and cover, high construction					CMAP 16LS229	29 x 2	MMAP 16LS240	40 x 2

¹⁾ May be combined with hoods:
- CMO/CMAO 16 X and CMV/CMAV 16 X
- MMO/MMAO 16 X and MMV/MMAV 16 X

N.B.: the enclosures ensure IP66 protection (or IP65 cover versions) rating when mated and locked with the closing levers.
The cover (CS, CP) only ensures mechanical protection, but does not ensure IP65 protection rating.

dimensions in mm
CMP - CMAP and MMP - MMAP

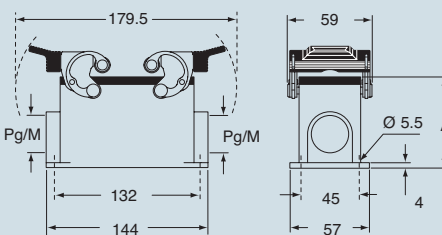

CMP CS/CP - CMAP CS/CP and MMP CS/CP - MMAP CS/CP

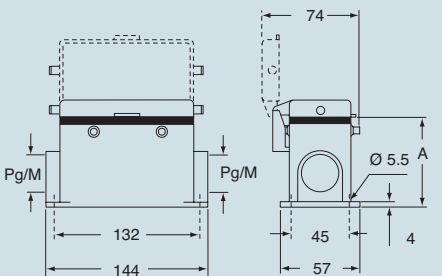

type	A
CMP / MMP	63
CMA / MMAP	81
CMP CS / MMP CS	63
CMA CS / MMAP CS	81
CMP CP / MMP CP	63
CMA CP / MMAP CP	81

dimensions in mm
CMP L - CMAP L and MMP L - MMAP L

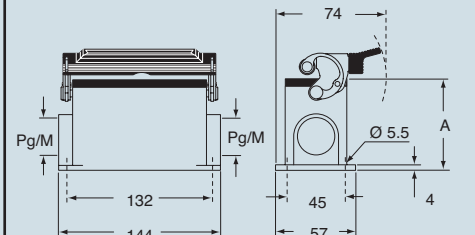

CMP LS - CMAP LS and MMP LS - MMAP LS

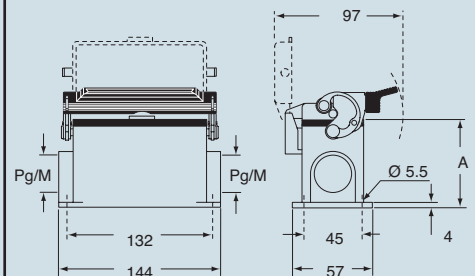

type	A
CMP L / MMP L	63
CMA L / MMAP L	81
CMP LS / MMP LS	63
CMA LS / MMAP LS	81

CMAUS® Type 4/4X/12

(excluding enclosures with plastic cover)

dimensions indicated are not binding and may be changed without notice

size 104.27



inserts:	page
CME 10 + 2 (aux) poles + ⊕	119
CME, CMCE 16 + 2 (aux) poles + ⊕	124

insert centre distance:
104 x 27 mm

hoods with 4 pegs



hoods with 2 pegs



description	part No.		part No.		part No.		part No.	
		entry Pg		entry M		entry Pg		entry M
with pegs, side entry	CMO 16	21	MMO 16.25	25	CMO 16 L	21	MMO 16 L25	25
with pegs, side entry			MMO 16.32	32			MMO 16 L32	32
with pegs, side entry, high construction	CMAO 16.21	21	MMAO 16.32	32	CMAO 16 L21	21	MMAO 16 L32	32
with pegs, side entry, high construction	CMAO 16.29	29	MMAO 16.40	40	CMAO 16 L29	29	MMAO 16 L40	40
with pegs, top entry	CMV 16	21	MMV 16.25 **	25	CMV 16 L	21	MMV 16 L25	25
with pegs, top entry			MMV 16.32	32			MMV 16 L32	32
with pegs, top entry	CMV 16.29	29	MMV 16.40	40	CMV 16 L29	29	MMV 16 L40	40
with pegs, top entry, high construction	CMAV 16.21	21	MMAV 16.32	32	CMAV 16 L21	21	MMAV 16 L32	32
with pegs, top entry, high construction	CMAV 16.29	29	MMAV 16.40	40	CMAV 16 L29	29	MMAV 16 L40	40
with pegs, frontal entry, high construction	CMAF 16.21	21	MMAF 16.25	25				
with pegs, frontal entry, high construction	CMAF 16.29	29	MMAF 16.32	32				
with pegs, frontal entry, high constr., without adaptor *	CMFF 16.21	21	MMFF 16.25	25				
with pegs, frontal entry, high constr., without adaptor *	CMFF 16.29	29	MMFF 16.32	32				

* enclosure without adaptor, threaded on the body, to be used only with a complete cable clamp.

** can only be used with a complete cable clamp (to be purchased separately)

dimensions in mm

CMO (CMAO) and MMO (MMAO)

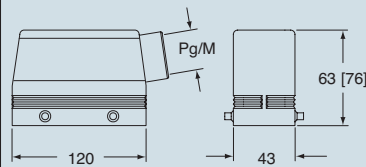

dimensions in mm

CMO L (CMAO L) and MMO L (MMAO L)

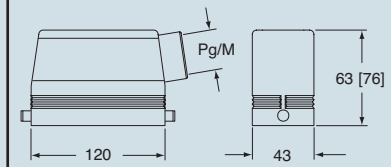

CMV (CMAV) and MMV (MMAV)

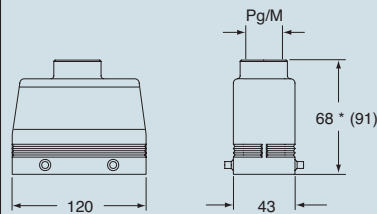

* 69.5 for Pg 29 - M 40 versions

CMV L (CMAV L) and MMV L (MMAV L)

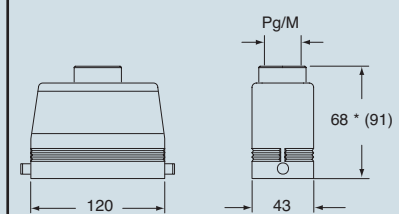

* 69.5 for Pg 29 - M 40 versions

CMAF/CMFF and MMAF/MMFF

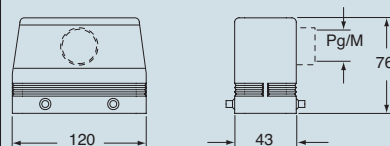

CALUS® Type 4/4X/12

dimensions indicated are not binding and may be changed without notice

size 104.27



inserts: page

CME 10 + 2 (aux) poles + ⊕ 119
 CME, CMCE 16 + 2 (aux) poles + ⊕ 124

insert centre distance:
 104 x 27 mm

hoods with 2 levers



hoods with single lever



description	part No.		part No.		part No.		part No.	
	entry Pg	entry M	entry Pg	entry M	entry Pg	entry M	entry Pg	entry M
with levers and gasket, top entry	CMV 16 G	21	MMV 16 G32	32	CMV 16 LG	21	MMV 16 LG32	32
with levers and gasket, top entry, high construction	CMAV 16 G	21	MMAV 16 G25	25	CMAV 16 LG21	21	MMAV 16 LG25	25
with levers and gasket, top entry, high construction	CMAV 16 G29	29	MMAV 16 G32	32	CMAV 16 LG29	29	MMAV 16 LG32	32
with levers and gasket, top entry, high constr., without adaptor *	CMFV 16 G	21	MMFV 16 G25	25	CMFV 16 LG21	21	MMFV 16 LG25	25
with levers and gasket, top entry, high constr., without adaptor *	CMFV 16 G29	29	MMFV 16 G32	32	CMFV 16 LG29	29	MMFV 16 LG32	32

* enclosure without adaptor, threaded on the body, to be used only with a complete cable clamp.

dimensions in mm

**CMV G (CMAV G) and [CMFV G],
 MMV G (MMAV G) and [MMFV G]**

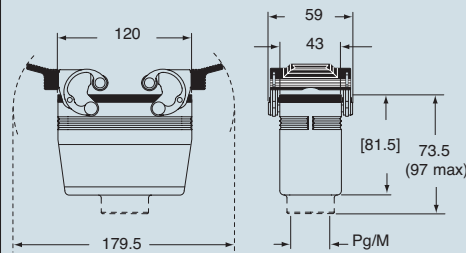

dimensions in mm

**CMV LG (CMAV LG) and [CMFV LG],
 MMV LG (MMAV LG) and [MMFV LG]**

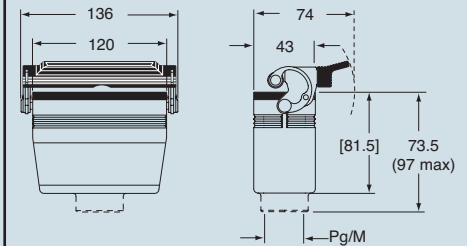

size 104.27

CALUS® Type 4/4X/12

dimensions indicated are not binding and may be changed without notice



inserts:	page
CME 10 + 2 (aux) poles + ⊕	119
CME, CMCE 16 + 2 (aux) poles + ⊕	124

insert centre distance:
104 x 27 mm

Covers G and LG version are not suitable to be used with code pins. If this application is required please contact ILME SpA.

hoods with 2 levers



covers



description	part No.	entry Pg	part No.	entry M	part No.
with levers, side entry ¹⁾	CMO 16 X	21	MMO 16 X25	25	
with levers, side entry ¹⁾			MMO 16 X32	32	
with levers, side entry, high construction ¹⁾	CMAO 16 X	21	MMAO 16 X32	32	
with levers, side entry, high construction ¹⁾	CMAO 16 X29	29	MMAO 16 X40	40	
with levers, top entry ¹⁾	CMV 16 X	21	MMV 16 X25	25	
with levers, top entry ¹⁾			MMV 16 X32	32	
with levers, top entry, high construction ¹⁾	CMAV 16 X	21	MMAV 16 X32	32	
with levers, top entry, high construction ¹⁾	CMAV 16 X29	29	MMAV 16 X40	40	
with 4 pegs (for enclosures with 2 levers with gasket)					CHC 24
with 4 pegs and gasket (for enclosures with 2 levers) ²⁾					CHC 24 C
with 2 pegs (for enclosures with 1 lever with gasket)					CHC 24 L
with 2 levers (for hoods with 4 pegs)					CHC 24 G
with 1 lever (for hoods with 2 pegs)					CHC 24 LG

¹⁾ May be combined with housings:
- CMI/CMP/CMAV 16 CS
- MMP/MMAV 16 CS

²⁾ May be combined with housings:
- CMO/CMAO 16 X and CMV/CMAV 16 X
- MMO/MMAO 16 X and MMV/MMAV 16 X

dimensions in mm

CMO X (CMAO X) and MMO X (MMAO X)

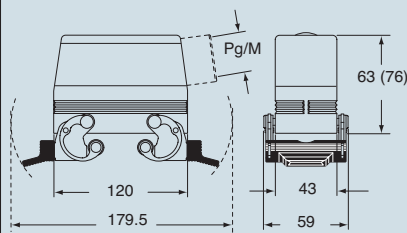

CMV X (CMAV X) and MMV X (MMAV X)

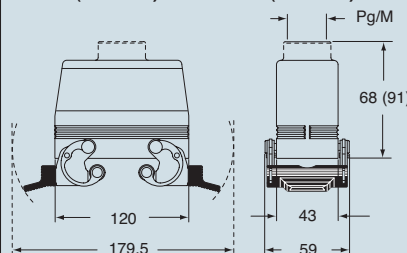

dimensions in mm

CHC



CHC C



CHC L

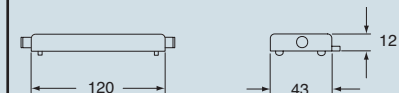

CHC G

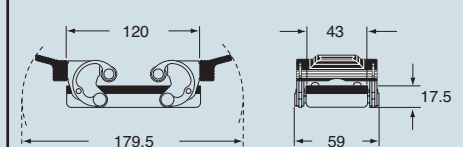

CHC LG

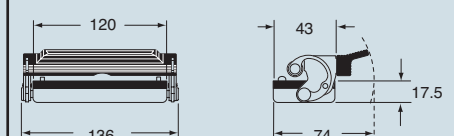

CALUS® Type 4/4X/12

dimensions indicated are not binding and may be changed without notice

size 104.27



inserts:		page
CN RY	24 poles + ⊕	83
CNE RY	24 poles + ⊕	93
CP RY	6 poles + ⊕	127

insert centre distance:
104 x 27 mm

The covers for G versions cannot be used together with coding pins. If this application is required, please contact ILME SpA.

housings and cover

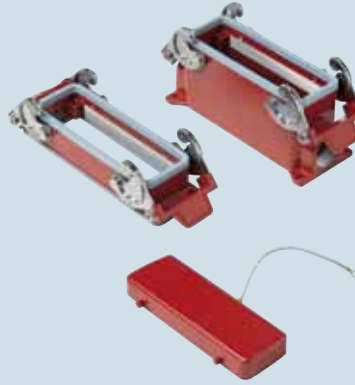

hoods and cover



description	part No.		part No.		part No.		part No.	
	entry Pg	entry M	entry Pg	entry M	entry Pg	entry M	entry Pg	entry M
bulkhead mounting, with levers surface mounting, with levers, high construction	---	---	---	---				
cover with 4 pegs (for housings)								
with pegs, side entry					CHOR 24	21	MHOR 24.25	25
with pegs, side entry, high construction					CAOR 24.29	29	MAOR 24.40	40
with pegs, top entry					CHVR 24	21	MHVR 24.25	25
with pegs, top entry, high construction					CAVR 24.29	29	MAVR 24.40	40
cover with 2 levers (for hoods)					CHCR 24 G			

panel cut-out for bulkhead mounting housings in mm

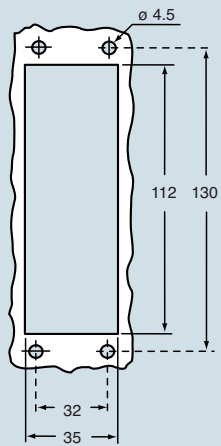

dimensions in mm

CHIR

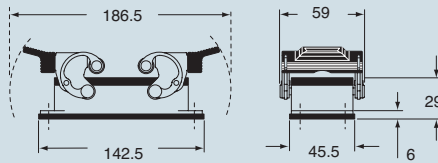

CAPR and MAPR

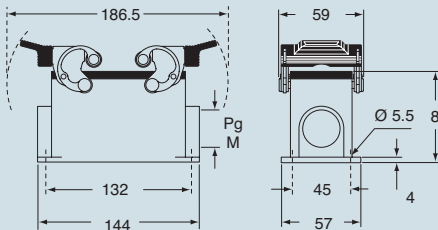

CHCR



dimensions in mm

CHOR (CAOR) and MHOR (MAOR)

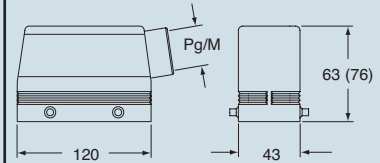

CHVR (CAVR) and MHVR (MAVR)

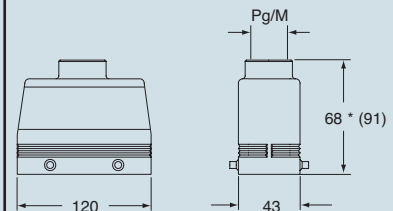

* 69.5 for Pg 29 - M 40 versions

CHCR G

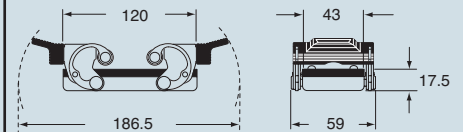

CALUS® Type 4/4X/12

dimensions indicated are not binding and may be changed without notice

size 104.27



inserts:	page
CD	64 poles + ⊕ 45
CT, CTS *) (10A)	64 poles + ⊕ 51
CDD	108 poles + ⊕ 58
CQE	46 poles + ⊕ 77
CN	24 poles + ⊕ 83
CCE	24 poles + ⊕ 92
CNE, CSE	24 poles + ⊕ 93
CSS	24 poles + ⊕ 101
CTE, CTSE *) (16A)	24 poles + ⊕ 109
CMSE	10+2 (aux) poles + ⊕ 118
CMCE	10+2 (aux) poles + ⊕ 118
CME	10+2 (aux) poles + ⊕ 119
CME	16+2 (aux) poles + ⊕ 124
CMCE	16+2 (aux) poles + ⊕ 124
CX	4/8 poles + ⊕ 133
MIXO	6 modules 137÷151

insert centre distance: 104 x 27 mm

*) only for enclosure CHIW 24

housings and cover



hoods and cover



description	part No.	entry Pg	part No.	entry M	part No.	entry Pg	part No.	entry M
bulkhead mounting, with levers	CHIW 24	---						
surface mounting, with levers, high construction	CAPW 24.21	21	MAPW 24.32	32				
cover with 4 pegs (for enclosures with 2 levers)	CHCW 24							
with pegs, side entry					CHOW 24	21	MHOW 24.25	25
with pegs, side entry					CAOW 24.29	29	MHOW 24.32	32
with pegs, side entry, high construction							MAOW 24.32	32
with pegs, side entry, high construction							MAOW 24.40	40
with pegs, top entry					CHVW 24	21	MHVW 24.25	25
with pegs, top entry							MHVW 24.32	32
with pegs, top entry, high construction					CAVW 24.29	29	MAVW 24.32	32
with pegs, top entry, high construction							MAVW 24.40	40
cover with 2 levers (for enclosures with 4 pegs)					CHCW 24 G			
with lever and gasket, top entry					CHVW 24 G	21	MHVW 24 G32	32

panel cut-out for bulkhead mounting housings in mm

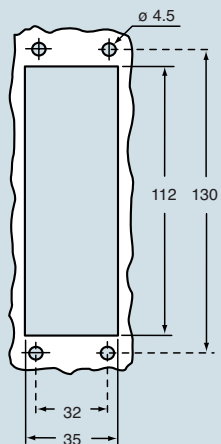

The covers for G versions cannot be used together with coding pins. If this application is required, please contact ILME SpA.

ILME® Type 4/4X/12

dimensions indicated are not binding and may be changed without notice

dimensions in mm

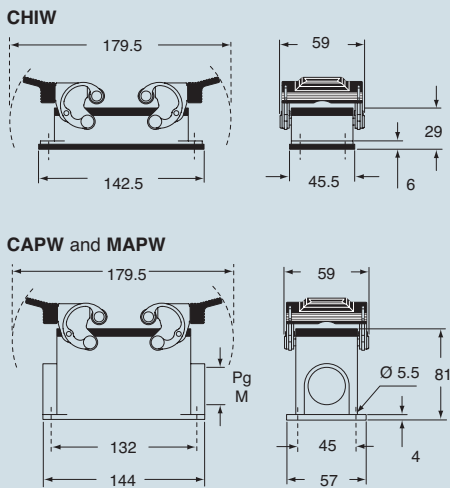

CHCW



dimensions in mm

CHOW (CAOW) and MHOW (MAOW)

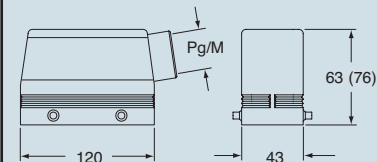

CHVW (CAVW) and MHVW (MAVW)

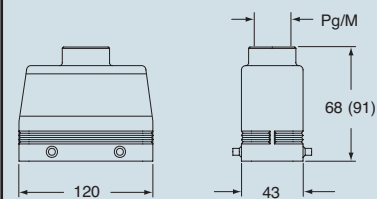

CHCW G

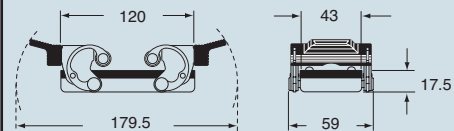

CHVW G and MHVW G

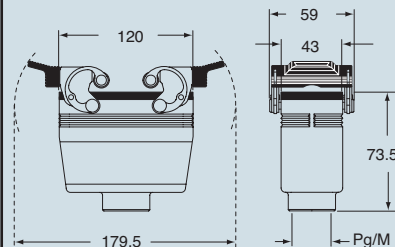

size 104.27



inserts:		page
CD	64 poles + ⊕	45
CT, CTS *) (10A)	64 poles + ⊕	51
CDD	108 poles + ⊕	58
CQE	46 poles + ⊕	77
CN	24 poles + ⊕	83
CCE	24 poles + ⊕	92
CNE, CSE.....	24 poles + ⊕	93
CSS	24 poles + ⊕	101
CTE, CTSE *) (16A)	24 poles + ⊕	109
CMSE	10+2 (aux) poles + ⊕	118
CMCE	10+2 (aux) poles + ⊕	118
CX	4/8 poles + ⊕	133
MIXO	6 modules	137÷151

insert centre distance: 104 x 27 mm

*) only for enclosure CHIS 24

housings and cover for electromagnetic compatibility

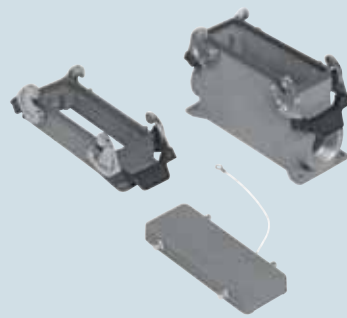

hoods and cover for electromagnetic compatibility



description	part No.		part No.		part No.		part No.	
		entry Pg		entry M		entry Pg		entry M
bulkhead mounting, with levers	CHIS 24	---						
surface mounting, with levers, high construction	CAPS 24.21	21	MAPS 24.32	32				
cover with 4 pegs (for enclosures with 2 levers)	CHCS 24							
with pegs, side entry					CHOS 24	21	MHOS 24.25	25
with pegs, side entry					CAOS 24.29	29	MHOS 24.32	32
with pegs, side entry, high construction							MAOS 24.32	32
with pegs, side entry, high construction							MAOS 24.40	40
with pegs, top entry					CHVS 24	21	MHVS 24.25	25
with pegs, top entry							MHVS 24.32	32
with pegs, top entry, high construction					CAVS 24.29	29	MAVS 24.32	32
with pegs, top entry, high construction							MAVS 24.40	40
cover with 2 levers (for enclosures with 4 pegs)					CHCS 24 G			

panel cut-out for bulkhead mounting housings in mm

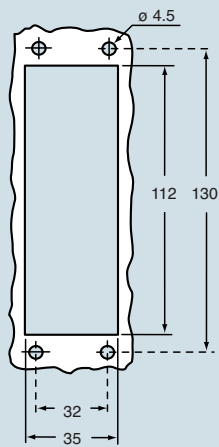

The covers for G versions cannot be used together with coding pins. If this application is required, please contact ILME SpA.

dimensions in mm

CHIS

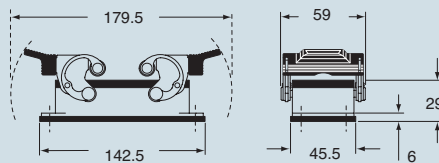

CAPS and MAPS

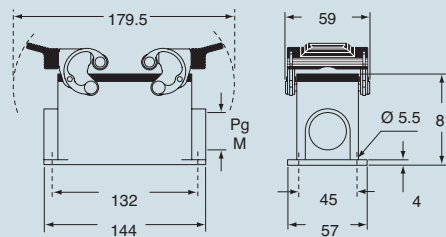

CHCS

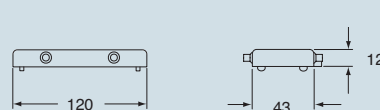

dimensions in mm

CHOS (CAOS) and MHOS (MAOS)

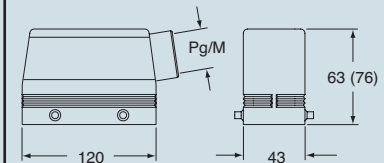

CHVS (CAVS) and MHVS (MAVS)

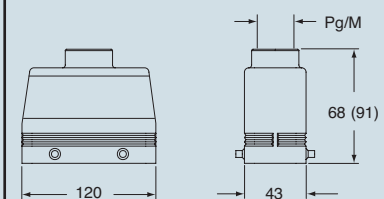

CHCS G

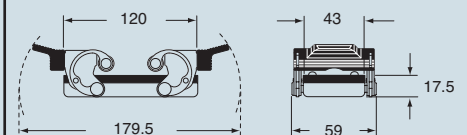

ILME® Type 4/4X/12

dimensions indicated are not binding and may be changed without notice

size 104.27

X-ON Electronics

Largest Supplier of Electrical and Electronic Components

Click to view similar products for [Standard Circular Connector](#) category:

Click to view products by [ILME](#) manufacturer:

Other Similar products are found below :

[C015 10F006 001 1](#) [5M2530B10P](#) [600247N007](#) [600259N006](#) [600273N007](#) [600432N009](#) [6280-2PG-519](#) [6280-3PG-311](#) [6280-3SG-311](#)
[6280-7SG-3DC](#) [6280-7SG-522](#) [6282-5PG-311](#) [6282-6PG-519](#) [6282-8SG-311](#) [6283-11](#) [6283-15](#) [6290](#) [6293](#) [6382-2PG-311](#) [6382-2PG-3DC](#)
[6382-2SG-321](#) [6382-2SG-3DC](#) [6382-4SG-516](#) [67-03E20-37P](#) [681-PMG](#) [CXS3102A14S2P](#) [CXS3102A181S](#) [CXS3106A14S6S](#)
[D38999/20FC8SA L/C](#) [MB12P-1](#) [MB12R-6](#) [7251-2PG-300](#) [7251-2SG-300](#) [7251-4PG-300](#) [7251-4SG-300](#) [7251-5PG-300](#) [7251-5SG-300](#)
[7251-6SG-300](#) [7251-7PG-300](#) [7251-8PG-300](#) [7271-6SG-300](#) [7282-3PG-300-CH3](#) [73000005663](#) [75-190011-03P](#) [75-190216-08S](#) [75-190218-](#)
[10P](#) [75-214636-52P](#) [75-474118-10P](#) [75-474211-03P](#) [75-474218-19S](#)