

**GENERAL PURPOSE TOGGLE SWITCHES - AC RATED**

Listings Below Are UL Recognized and CSA Certified.  
Threaded Bushings Are 15/32 Inches in Diameter  
And Mounting Hardware Is Including

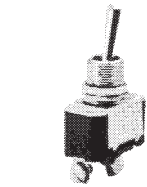

1 Pole

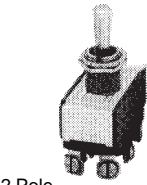

2 Pole

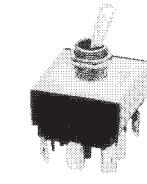

3 Pole

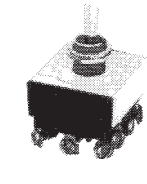

4 Pole

Nominal Ratings			Poles and Throw	Circuits	Bushing Length	Catalog Numbers						
125V AC	250V AC	HP 250V AC				Solder Lugs	Price	Screw Terminals	Price	.250 Spade Terminals	Price	
6	3		1 P.S.T.	ON - NONE - OFF	0.344	7580K7	\$1.93					
					0.469	7580K6	1.93	7580K4	\$2.15	7580K9	\$1.93	
			1 P.D.T.	ON - OFF - ON	0.469	7581K6	2.23	7581K4	2.60	7581K8	2.23	
						7800K11	2.30	7800K13	2.35			
			1 P.S.T.	ON - NONE - ON								
				ON - NONE - OFF	0.469	7501K13	2.04	7500K14	2.17	7501K15	2.04	
			1 P.D.T.	ON - OFF - ON	0.469	7502K11	2.36	7802K31	2.63	7802K15	2.36	
						7503K13	2.50	7502K13	2.78	7503K15	2.52	
			1 P.D.T.	ON - NONE - ON	0.469	7802K12	2.80	7802K32	3.28	7802K22	2.82	
				ON - NONE - OFF		7505K4	2.52	7504K4	2.97	7505K6	2.52	
			1 P.D.T.	ON - NONE - ON	0.469	7802K13	2.73	7802K33	3.19	7802K23	2.80	
				ON-Mom - OFF - ON Mom				7802K37	5.73			
			1 P.S.T.	ON Mom-OFF-ON Mom	0.469			7509K5	4.01			
				ON - NONE - OFF	0.344			7576K2	6.28			
			2 P.S.T.	ON - NONE - OFF	0.469	7590K6	2.95	7590K4	3.47			
						7801K11	3.04					
			2 P.D.T.	ON - OFF - ON	0.469	7591K6	3.26	7591K4	4.13			
				ON - NONE - ON	0.469	7801K12	3.41					
			2 P.S.T.	ON - NONE - ON	0.469	7592K6	3.39	7592K4	4.13	7592K8	3.12	
						7801K13	3.60					
			2 P.D.T.	ON - NONE - OFF	0.469	7561K4	3.26	7560K5	3.65	7561K6	3.26	
				ON - OFF - ON	0.469	7803K11	3.54	7803K31	4.19	7803K21	3.54	
			2 P.D.T.	ON - OFF - ON	0.469	7563K4	3.89	7562K4	4.48	7563K6	3.89	
						7803K12	4.19	7803K32	5.17	7803K22	4.19	
			2 P.D.T.	ON - NONE - ON	0.469	7565K5	3.65	7564K6	4.76	7565K7	3.80	
				ON - OFF - ON Mom	0.469	7803K13	4.19	7803K33	5.17	7803K23	4.19	
			3 P.S.T.	ON - NONE - OFF	0.469			7803K70	7.71			
				ON Mom-OFF-ON Mom	0.469			7803K37	8.26			
			3 P.D.T.	ON - NONE - OFF	0.469	7700K1	6.30	7700K2	7.30	7700K3	6.43	
				ON - OFF - ON	0.469	7701K1	7.93	7701K2	8.80	7701K3	7.93	
			3 P.D.T.	ON - NONE - ON	0.469	7702K1	7.93	7702K2	8.80	7702K3	7.93	
				ON - NONE - OFF	0.515			8320K1	22.54			
			4 P.S.T.	ON - NONE - OFF	0.469	7691K14	8.04	7690K8	8.91			
				ON - OFF - ON	0.469	7693K2	9.60	7692K13	11.10			
			4 P.D.T.	ON - NONE - ON	0.469	7695K5	9.60	7694K4	11.10			
				ON - OFF - ON	0.469	7805K12	12.13	7805K32	13.73			
			4 P.D.T.	ON - NONE - ON	0.469	7805K13	12.13	7805K33	13.73			
				ON - OFF - ON	0.469							

*Introducing COMBI-TERM Switches.  
The one universal termination that satisfies all wire connections on a single switch.  
45 terminal combinations from 15 switches*

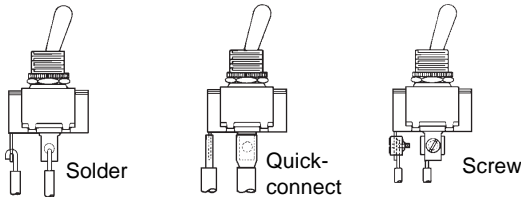

**General Purpose Toggle Switches ac/dc Rated**

Mounting hardware and terminal screws (where applicable) are furnished, unassembled.  
Threaded bushing - 0.468" -32  
Bright nickel plated bushing and bat lever  
Wire leads are 18 gauge, 6" long, skinned 3/4"  
All listings are UL recognized and CSA certified



1 Pole

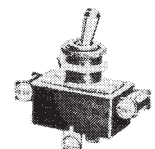

2 pole

**Combi-Term Series Bat Lever**

Catalog Number	Price	Rating	Poles	Circuits
7802K41	\$ 3.02	15A, 125F AC	SPST	ON - NONE - OFF
7802K44	5.71	10A, 250V AC	SPDT	Mom ON - NONE - OFF
7802K42	3.73	3/4-HP,		ON - OFF - ON
7802K43	3.60	120 - 240V AC	DPST	ON - NONE - ON
7802K45	7.56			Mom ON - NONE - ON
7802K46	5.71		DPDT	Mom ON - OFF - ON
7803K41	4.63			ON - NONE - OFF
7803K42	5.71		3PST	ON - OFF - ON
7803K43	5.67			ON - NONE - ON
7803K47	9.06		3PDT	Mom ON - OFF - Mom ON
7804K41	9.56	16A, 125V AC		ON - NONE - OFF
7804K42	12.10	10A, 250V AC	4PDT	ON - OFF - ON
7804K43	13.82	1HP, 120V AC 1, 2 & 3 Phase		ON - NONE - ON
7805K42	13.00	10A, 250V AC	4PDT	ON - OFF - ON
7805K43	15.10	1/2 HP, 120 - 240 VAC 2 & 3 Phase		ON - NONE - ON

Catalog Number	Price	Ratings	Poles	Bushing Length	Termination
8282K113	\$ 3.50	3A, 125V ac/dc	SPDT	0.344	Solder
8282K114	3.50	1A, 250Vdc		0.469	Solder
8280K115	2.54	3A, 250Vdc	SPST	0.344	Solder
8295K107	3.56			0.469	Screw
8290K115	3.06				Wire Lead
8280K116	3.06	6A, 125V ac/dc	DPST	0.344	Solder
8295K108	3.50				Screw
8290K116	3.06	3A, 250Vdc	DPST	0.469	Wire Lead
8381K107	2.63				Solder
8396K107	3.08				Screw
8391K107	3.08				Wire Lead
8381K108	2.63	6A, 125V ac/dc	DPST	0.469	Solder
8396K108	3.08				Screw
8370K107	4.60	3A, 250Vdc	DPST	0.469	Solder
8372K107	5.93				Screw
8371K107	5.93				Wire Lead
8373K107	5.32				Solder
8375K107	6.82				Screw
8374K107	7.50				Wire Lead

## Miniature Toggle Switches

6 amp, 125 VAC, 3 amp, 250 VAC, 6 amp @ 28 VDC resistive. UL recognized, CSA certified. Mounting hardware included. Switches listed have BAT handle levers. Many options are available on this miniature series, such as special handles, bushings, terminals, contact material and special finishes. If you need complete specifications, please request PUBL. NO. NC-169 "Miniature Switches".

Part Number	Price	Poles & Throw	Circuits			Bushing	Terminals
			Up	Center	Down		
A121S1YZQ	\$4.15	S.P.D.T.	ON	OFF	ON	1/4-40X.352	Solder Lugs
A121S1YCQ	4.39	S.P.D.T.	ON	OFF	ON	1/4-40X.352	Printed Cir
A123S1YZQ	3.50	S.P.D.T.	ON	NONE	ON	1/4-40X.352	Solder Lugs
A123S1YCQ	3.84	S.P.D.T.	ON	NONE	ON	1/4-40X.352	Printed Cir
A121M1D9AB *	4.76	S.P.D.T.	ON	OFF	ON	1/4 SmoothX.280	Rt. Angle P.C.
A123M1D9AB *	4.21	S.P.D.T.	ON	NONE	ON	1/4 SmoothX.280	Rt. Angle P.C.
A126M1D9AB *	4.76	S.P.D.T.	ON	NONE	ON Mom	1/4 SmoothX.280	Rt. Angle P.C.
A127M1D9AB *	4.76	S.P.D.T.	ON Mom	OFF	ON Mom	1/4 SmoothX.280	Rt. Angle P.C.
A126S1YCQ	4.39	S.P.D.T.	ON	NONE	ON Mom	1/4-40X.352	Printed Cir
A126S1YZQ	4.15	S.P.D.T.	ON	NONE	ON Mom	1/4-40X.352	Solder Lugs
A127S1YCQ	4.39	S.P.D.T.	ON Mom	OFF	ON Mom	1/4-40X.352	Printed Cir
A127S1YZQ	4.15	S.P.D.T.	ON Mom	OFF	ON Mom	1/4-40X.352	Solder Lugs
A131S1YZQ	4.15	S.P.D.T.	ON	OFF	ON Mom	1/4-40X.352	Solder Lugs
A221S1YZQ	6.21	D.P.D.T.	ON	OFF	ON	1/4-40X.352	Solder Lugs
A223S1YZQ	4.66	D.P.D.T.	ON	NONE	ON	1/4-40X.352	Solder Lugs
A223S1YCQ	5.47	D.P.D.T.	ON	NONE	ON	1/4-40X.352	Printed Cir
A226S1YZQ	6.21	D.P.D.T.	ON	NONE	ON	1/4-40X.352	Solder Lugs
A226S1YCQ	5.80	D.P.D.T.	ON	NONE	ON Mom	1/4-40X.352	Printed Cir
A227S1YZQ	6.21	D.P.D.T.	ON Mom	OFF	ON Mom	1/4-40X.352	Solder Lugs
A227S1YCQ	6.39	D.P.D.T.	ON Mom	OFF	ON Mom	1/4-40X.352	Printed Cir
A231S1YZQ	5.70	D.P.D.T.	ON	OFF	ON Mom	1/4-40X.352	Solder Lugs
A232S1YZQ	6.65	D.P.D.T.	ON	ON	ON Mom	1/4-40X.352	Solder Lugs
A321S1YZQ	10.32	D.P.D.T.	ON	OFF	ON	1/4-40X.352	Solder Lugs
A323S1YZQ	9.80	3P.D.T.	ON	NONE	ON	1/4-40X.352	Solder Lugs
A323S1YCQ	9.95	3P.D.T.	ON	NONE	ON	1/4-40X.352	Printed Cir
A327S1YZQ	12.80	3P.D.T.	ON Mom	OFF	ON Mom	1/4-40X.352	Solder Lugs
A421S1YZQ	12.60	4P.D.T.	ON	OFF	ON	1/4-40X.352	Solder Lugs
A421S1YCQ	13.25	4P.D.T.	ON	OFF	ON	1/4-40X.352	Printed Cir
A423S1YZQ	12.00	4P.D.T.	ON	NONE	ON	1/4-40X.352	Solder Lugs
A423S1YCQ	12.20	4P.D.T.	ON	NONE	ON	1/4-40X.352	Printed Cir

\* Bat Lever, .200 " long Chrome. All others are .410 " long Chrome.

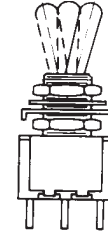

## Miniature Pushbutton Switches

Part Number	Price	Poles & Throw	Action	Cap	Terminals
PB12331ZQ	\$4.78	S.P.D.T.	ON - NONE - ON Push on - Push Off	.375 Dia, Black	Solder Lugs
PB12311ZQ	4.78	S.P.D.T.	ON - NONE - ON Push on - Push Off	.200 Dia, Black	Solder Lugs
PB12631ZQ	5.04	S.P.D.T.	ON - NONE - ON Mom	.375 Dia, Black	Solder Lugs
PB12611ZQ	5.04	S.P.D.T.	ON - NONE - ON Mom	.200 Dia, Black	Solder Lugs



## Keylite Pushbutton Switches - Illuminated or Non-Illuminated

### SPECIFICATIONS

Ratings - Switch - 10mA at 24 VDC.

Mechanical Life and Electrical Life - 5 million operations momentary, 10,000 maintained.

Initial contact resistance - 50 milliohms max.

Insulation resistance - 10<sup>9</sup> Ohms minimum

Contact Bounce - 2.0 ms maximum

Operating Force - 150 grams approx.

Total Key Travel - .098 (2.5mm)

Pre-Travel - .039 (1mm)

Ambient Temperature -25°C to +85°C (-13°F to 185°F)

Mounted Method - Direct soldering onto standard Matrix printed circuit board.

Interchangeable Keys - Large variety of colors

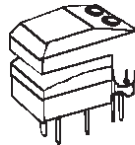

### MATERIALS:

Housing - Polycarbonate

Key Cap - ABS

Switching Contacts - Gold plate over silver plated brass

Part Number	Description	Price
SB6SDV143A6	Narrow one Red LED Black Key SPDT MOM	\$ 5.20
SB6SDV143A1	Narrow one Red LED White Key SPDT MOM	5.20
SB6SDV445A6	Narrow Two Red LEDs Black Key SPDT MOM	5.93
SB6SDV445A1	Narrow Two Red LEDs White Key SPDT MOM	5.93
SB6SDV641A6	Narrow No LED Black Key SPDT MOM	4.30
SB6SDV641A1	Narrow No LED White Key SPDT MOM	4.30

**Sensitive Snap-Action Push-button Switches -  
Solder and P.C. Terminals (Momentary Action)**

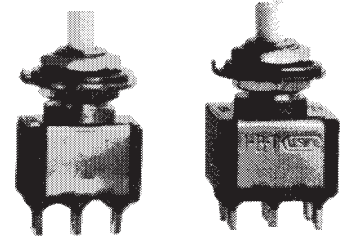

One Pole

Two Pole

Part Number Switch w/o Cap	Price	Poles & Throw	Terminals	CAPS	Price
<b>PS1100 Q</b>	<b>\$5.75</b>	S.P.D.T.	Solder Lugs	W-KN-17 Black Cap, .375 Dia X .250 High	<b>\$0.26</b>
<b>PS1200 Q</b>	<b>8.00</b>	D.P.D.T.	Solder Lugs	W-KN-17A White Cap, .375 X .25	<b>0.32</b>
<b>PS2100 Q</b>	<b>6.00</b>	S.P.D.T	Printed Cir	W-KN-17B Red Cap, .375 X .25	<b>0.26</b>
<b>PS2200 Q</b>	<b>8.50</b>	D.P.D.T.	Printed Cir	Other sizes and color caps are available on special order.	

Single pole circuit rated 5 amps, Double pole circuit rated 1 amp.

**General Purpose Pushbutton Switches ac Rated**

One hole, flush and snap in mounting  
Slow make, slow break contact mechanism  
Mounting hardware (where applicable) consists of one hexagon locknut and one bright nickel plated curled face nut (except 8411 which has a bright nickel plated hexagon face nut)  
Bushings are 0.468" - 32 threaded - keyways are 0.068" wide by 0.035" deep  
Bushings and metal buttons are bright nickel plated  
Terminal screws and mounting hardware are furnished unassembled  
All switches below are UL recognized and CSA Certified.

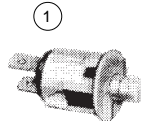

**8411**  
One hole Mounted Light Duty  
Momentary Contact

Type	Nominal Ratings		Poles and Throw	Mounting or Bushing Length	Button			Typical max. Operating Force	Contacts	Catalog Numbers					
	Amperes	ac / dc			Construction	Extension Length In.	Color			Screw Terminals	Price	Solder Lugs	Price	Spade (.250")	Price
①	3/4	1/4	1P.S.T.	Snap-in		3/8 3/8	White White	---	N.C. N.O.	---		---		8423K1# 8424K1#	\$1.75 1.80
②	3/4	1/4	1 P.S.T.	1/4	Nylon	1/4	Black	1.5 lbs.	N.C.	---		8411K5	\$3.40	---	
				1/4	Nylon	1/4	Red	1.5 lbs.	N.O.	---		---		8411K13#	1.78
				15/32	Nylon	13/32	Black	1.5 lbs.	N.C.	8411K7	\$2.28	8411K8	1.91	8411K10	3.15
				15/32	Nylon	3/8	Black	1.5 lbs.	N.O.	8411K12	2.08	---		8411K11#	1.73

# Combination Solder lug and spade terminal.

The listings below are all momentary contact normally open except number 8434 which has one N.O. and one N.C. contact.

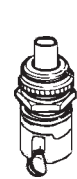

**8440**  
(1 P.S.T.)

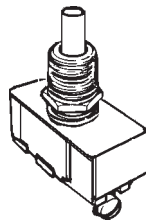

**8434**  
(1 P.D.T.)

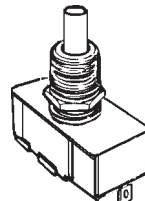

**8442/8443**  
(1 P.S.T.)

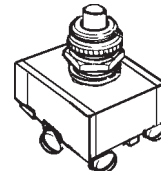

**8448**  
(2 P.S.T.)

Nominal Ratings				Hp 125-250V	Poles and Throw	Button			Maximum Operating Force	Bushing Length	Catalog Number with Screw Terminals	Price
Amperes ac						Material	Color	Extension inches				
125V	250V	N.O.	N.C.									
* 3					Metal		19/64	2.5 lbs	15/32	8440K3	\$5.80	
6		3			Metal Metal Phenolic	Black	17/32 1/4 17/32	0.9 lbs 0.9 lbs 0.8 lbs	11/16 11/32 11/16	8442K3 8442K4 8443K2	3.50 3.41 5.89	
15		10		1/3	Metal Phenolic	Black	17/32 17/32	0.9 lbs 0.8 lbs	11/16 11/16	8444K3 8445K2	3.65 12.06	
15		10	5	1/2	Metal		17/32	2.0 lbs	11/16	8434K2	4.95	
15		10			Metal		1/4		11/32	8448K2	6.40	

\* Rated 5 amps at 12VDC

**MIL-S-83731 SWITCHES WITH LEVER SEAL**

**STANDARD LEVER SELECTION TABLE**

Circuit with Lever in			Screw Terminals				Poles/ Fig. No.
Up Position	CENTER Position	DOWN Position (Keyway)	MS Part Number	Part Number	Price		
ON	OFF	ON	MS35058-21	<b>8800K16</b>	<b>\$9.23</b>	One Pole <b>(1)</b>	
ON	NONE	OFF	MS35058-22	<b>8801K22</b>	<b>8.34</b>		
ON	NONE	ON	MS35058-23	<b>8810K15</b>	<b>9.36</b>		
ON	OFF	NONE	MS35058-24	<b>8801K23</b>	<b>8.34</b>		
ON	OFF	ON	MS35058-27	<b>8812K14</b>	<b>9.86</b>		
OFF	NONE	ON	MS35058-30	<b>8811K17</b>	<b>9.00</b>		
ON	OFF	ON	MS35059-21	<b>8820K16</b>	<b>12.91</b>	Two Pole <b>(2)</b>	
ON	NONE	OFF	MS35059-22	<b>8822K20</b>	<b>11.60</b>		
ON	NONE	ON	MS35059-23	<b>8824K14</b>	<b>11.63</b>		
ON	OFF	NONE	MS35059-24	<b>8822K21</b>	<b>11.60</b>		
ON	NONE	ON	MS35059-26	<b>8830K13</b>	<b>16.10</b>		
ON	OFF	ON	MS35059-27	<b>8834K5</b>	<b>16.71</b>		
ON	OFF	ON	MS35059-31	<b>8832K6</b>	<b>15.89</b>	Four Pole <b>(3)</b>	
ON	OFF	ON	MS25068-21	<b>7662K7</b>	<b>28.45</b>		
ON	NONE	ON	MS25068-23	<b>7664K5</b>	<b>25.63</b>		

- Meets MIL-S-83731 Military requirements
- Silicone rubber lever seal prevents entry of contaminants
- Silver to Silver Contacts
- Screw terminals also tin dipped to facilitate soldering
- Standard toggle length 11/16" - Bushing height 15/32"
- Bushing 15/32" - 32 thread
- Terminal screws #6-32
- Terminal and mounting furnished unassembled

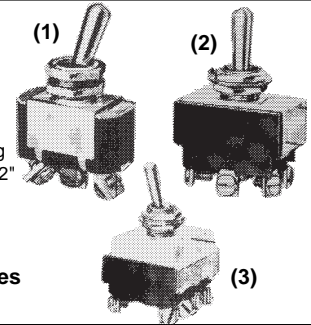

**CURRENT RATINGS - Standard Lever Switches**

Current Capacity in Amperes Per Pole

Switch	Type Operator	28V dc			115V ac 400Hz			115 ac 60Hz	
		Lamp Load	Resis- tive Load	Inductive Load	Lamp Load	Resis- tive Load	Inductive Load	Resis- tive Load	Inductive Load
MS35058	Maintained	7	25	15	3	10	10	10	10
	Momentary	5	20	10	2	10	7	10	7
MS35059	Maintained	7	20	15	4	20	15	20	-
	Momentary	5	18	10	2	11	8	11	-
MS25068	Maintained	5	20	12	4	20	15	-	-
	Momentary	4	18	10	2	11	5	-	-

**MIL-S-3950 ENVIRONMENTALLY SEALED SWITCHES**

**STANDARD LEVER SELECTION TABLE**

Circuit with Lever in			Screw Terminals				Poles/ Fig. No.
Up Position	CENTER Position	DOWN Position (Keyway)	MS Part Number	Part Number	Price		
ON	OFF	ON	MS24523-21	<b>8500K1</b>	<b>\$18.60</b>	One Pole <b>(1)</b>	
ON	NONE	OFF	MS24523-22	<b>8500K9</b>	<b>18.60</b>		
ON	NONE	ON	MS24523-23	<b>8500K4</b>	<b>18.60</b>		
ON	NONE	ON*	MS24523-26	<b>8500K5</b>	<b>18.60</b>		
*ON	OFF	ON*	MS24523-27	<b>8500K2</b>	<b>18.60</b>		
OFF	NONE	ON*	MS24523-30	<b>8500K11</b>	<b>18.60</b>		
ON	OFF	ON	MS24524-21	<b>8501K1</b>	<b>24.93</b>	Two Pole <b>(2)</b>	
ON	NONE	OFF	MS24524-22	<b>8501K9</b>	<b>24.93</b>		
ON	NONE	ON	MS24524-23	<b>8501K4</b>	<b>24.93</b>		
ON	NONE	ON*	MS24524-26	<b>8501K5</b>	<b>24.93</b>		
*ON	OFF	ON*	MS24524-27	<b>8501K2</b>	<b>24.93</b>		
OFF	NONE	ON*	MS24524-30	<b>8501K11</b>	<b>24.93</b>		
ON	OFF	ON*	MS24524-31	<b>8501K3</b>	<b>24.93</b>	Four Pole <b>(3)</b>	
ON	OFF	ON	MS24525-21	<b>8502K1</b>	<b>40.08</b>		
ON	NONE	ON	MS24525-23	<b>8502K4</b>	<b>40.08</b>		

- Environmentally sealed
- Meets MIL-S-3950 requirements
- Reliable momentary action
- Base material is self extinguishing
- Molded-in terminal inserts
- Flush Screw Terminals
- Full silicone seal - increased electrical insulation protection
- 15/32" - 32 threaded bushing - Keyway .076 ± .008

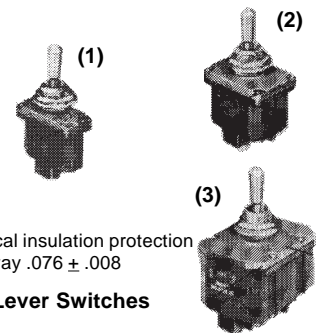

**CURRENT RATINGS - Standard Lever Switches**

Current Capacity in Amperes Per Pole

Switch	Type Operator	28V dc			115V ac 400Hz		
		Lamp Load	Resis- tive Load	Inductive Load	Lamp Load	Resis- tive Load	Inductive Load
MS24523	Maintained	5	20	10	3	15	7
	Momentary	4	15	10	2	15	7
MS24524	Maintained	7	20	15	4	15	15
	Momentary	5	18	10	2	11	8
MS24525	Maintained	5	20	12	4	15	15
	Momentary	4	18	10	2	11	8

\* Momentary Action

**MIL-S-8834 MINIATURE POSITIVE ACTION SWITCHES**

**STANDARD LEVER SELECTION TABLE - Small Lever**

Circuit with Lever in			Screw Terminals				Poles/ Fig. No.
Up Position	CENTER Position	DOWN Position (Keyway)	MS Part Number	Part Number	Price		
ON	OFF	ON	MS24655-211	<b>8866K1</b>	<b>\$52.65</b>	One Pole <b>(1)</b>	
ON	NONE	OFF	MS24655-221	<b>8866K7</b>	<b>52.65</b>		
ON	NONE	ON	MS24655-231	<b>8866K4</b>	<b>52.65</b>		
NONE	OFF	ON*	MS24655-281	<b>8866K6</b>	<b>56.84</b>		
ON	OFF	ON	MS24656-211	<b>8867K1</b>	<b>65.89</b>	Two Pole <b>(2)</b>	
ON	NONE	ON	MS24656-231	<b>8867K4</b>	<b>65.89</b>		
ON	OFF	ON*	MS24656-311	<b>8867K3</b>	<b>72.73</b>		

- Meets MIL-S-8834 requirements
- Sealed bushing
- Wiping action contacts - dry circuit carrying capabilities
- Positive Make and Break action
- Solder Lug terminals with .045/.050 diameter holes
- Bushing 1/4-40 threaded

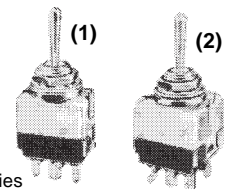

**CURRENT RATINGS - Standard Lever Switches**

Current Capacity in Amperes Per Pole; Minimum Rating: 25 microamps at 5 millivolts or less.

28V dc	50V dc	115V ac		28V dc	50V dc	115V ac	
		60 Hz	400 Hz			60 Hz	400 Hz
		5	1			2	3

\* Momentary Action



**Miniature Snap In Lighted and Non-Lighted Rocker Switches 1600 and 2600 Series**

The 1600 and 2600 series of miniature snap-in rocker switches have worldwide approvals, featuring a combination of UL, CSA, VDE, UTE, BEAB, FI, DEMKO, NEMKO, SEMKO and KEMA listings at up to 16 Amperes, 250 Volts AC.

**Mounting Means:** Snap in rectangular cutout:  
1500 & 1600 Base Type- .480" Wide x 1.071" Long  
2500 & 2600 Base Type- .872" Wide x 1.071" Long  
Minimum Panel Thickness .030"  
Maximum Panel Thickness .118"

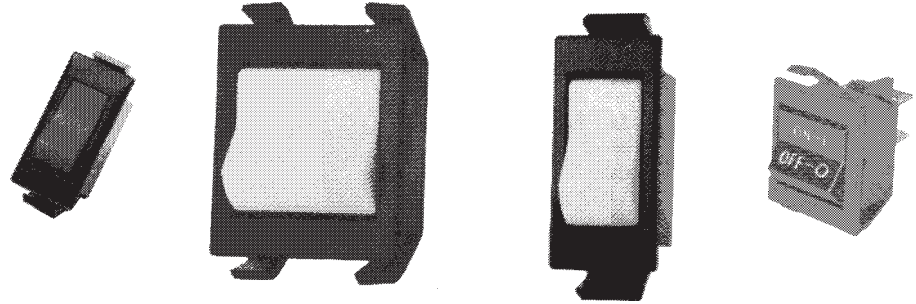

**NON- LIGHTED**

Part Number	Nominal Rating Amperes	Poles And Throw	Action With Lever			Description	Price
			Up	Center	Down		
1500-11E	15A, 125Vac 10A, 250Vac	SPST	ON	NONE	OFF	Black Base; BlackLever, Quick Disconnect	\$0.91
1500-11E014			MomON	NONE	OFF	Black Base; BlackLever, Quick Disconnect with ( I - O ) Legend	1.21
1501-11E			ON	OFF	ON	Black Base; BlackLever, Quick Disconnect	1.58
1504-11E	10A, 125 - 250Vac	SPST	MomON	OFF	MomON	Black Base; BlackLever, Quick Disconnect	1.42
1506-11E			MomON	OFF	MomON	Black Base; BlackLever, Quick Disconnect	2.56
1600-11E	16A, 125 - 250Vac	SPST	ON	NONE	OFF	Black Base; BlackLever, Quick Disconnect	1.04
1600-12E			ON	NONE	OFF	Black Base; White Lever; Quick Disconnect	1.04
1600H-11E	22A, 125Vac; 16A, 250Vac; 1HP, 125/250Vac	SPST	ON	NONE	OFF	Black Base; BlackLever, Quick Disconnect	1.25
1601-11E			Mom ON	NONE	OFF	Black Base; Black Lever, Quick Disconnect	1.34
1602-11E	16A, 125 - 250Vac	SPDT	ON	NONE	ON	Black Base; Black Lever; Quick Disconnect	1.54
1602-12E			ON	NONE	MomON	Black Base; White Lever; Quick Disconnect	1.54
1603-11E			ON	NONE	MomON	Black Base; Black Lever; Quick Disconnect	1.53
1603-12E			ON	NONE	MomON	Black Base; Black Lever; Quick Disconnect	1.53
1604-11E			ON	OFF	ON	Black Base; Black Lever; Quick Disconnect	1.48
1604-12E			ON	OFF	ON	Black Base; White Lever; Quick Disconnect	1.48
1604-22E	ON	OFF	ON	White Base; White Lever; Quick Disconnect	1.48		
2500-11E	15A, 125Vac 10A, 250Vac	DPST	ON	NONE	OFF	Black Base; Black Lever, Quick Disconnect	1.48
2500H-11E734			ON	NONE	OFF	Black Base; Black Lever, Quick Disconnect with ( ON-I / OFF-O ) Legend	1.96
2501-11E	15A, 125Vac	DPST	MomON	NONE	OFF	Black Base; Black Lever, Quick Disconnect	1.67
2502-11E	10A, 250Vac		ON	NONE	ON	Black Base; Black Lever, Quick Disconnect	2.03
2504-11E	10A, 125/250Vac	DPDT	ON	OFF	ON	Black Base; Black Lever, Quick Disconnect	2.12
2506-11E			MomON	OFF	MomON	Black Base; Black Lever, Quick Disconnect	2.85
2600-11E	16A, 125/250Vac	DPST	ON	NONE	OFF	Black Base; Black Lever, Quick Disconnect	1.60
2600-11E714			ON	NONE	OFF	Black Base; Black Lever, Quick Disconnect with ( I-O ) Legend	1.89
2600-12E			ON	NONE	OFF	Black Base; White Lever, Quick Disconnect	1.60
2600-13E	22A, 125Vac 16A, 250Vac 1HP, 125/250Vac	DPST	ON	NONE	OFF	Black Base; Red Lever, Quick Disconnect	1.60
2600H-11E			ON	NONE	OFF	Black Base; Black Lever, Quick Disconnect	1.82
2601-11E	16A, 125/250Vac	DPDT	MomON	NONE	OFF	Black Base; Black Lever, Quick Disconnect	1.82
2602-11E			ON	NONE	ON	Black Base; Black Lever, Quick Disconnect	2.14
2604-11E			ON	OFF	ON	Black Base; Black Lever, Quick Disconnect	2.24
2604-12E	ON	OFF	ON	Black Base; White Lever, Quick Disconnect	2.24		

**LIGHTED**

Part Number	Nominal Rating Amperes	Poles And Throw	Action With Lever			Description	Price
			Up	Center	Down		
1500A11E	15A, 125Vac 10A, 250Vac	SPST	ON	NONE	OFF	125V Neon, Amber Lens, Black Base, Quick Disconnect	\$2.19
1500G11E						125V Neon, Green Lens, Black Base, Quick Disconnect	2.19
1500R11E	125V Neon, Red Lens, Black Base, Quick Disconnect	2.19					
1600A11E	16A, 125 - 250Vac	SPST				125V Neon, Amber Lens, Black Base, Quick Disconnect	2.33
1600G11E						125V Neon, Green Lens, Black Base, Quick Disconnect	2.33
1600R11E						125V Neon, Red Lens, Black Base, Quick Disconnect	2.33
2500A11E	15A, 125Vac 10A, 250Vac	DPST				125V Neon, Amber Lens, Black Base, Quick Disconnect	2.65
2500G11E						125V Neon, Green Lens, Black Base, Quick Disconnect	2.65
2500R11E						125V Neon, Red Lens, Black Base, Quick Disconnect	2.65
2600A11E	16A, 125/250Vac	DPST				125V Neon, Amber Lens, Black Base, Quick Disconnect	2.88
2600A21E			250V Neon, Amber Lens, Black Base, Quick Disconnect	2.88			
2600G11E			125V Neon, Green Lens, Black Base, Quick Disconnect	2.88			
2600R11E			125V Neon, Red Lens, Black Base, Quick Disconnect	2.88			
2600HR11E			22A, 125Vac 16a, 250Vac 1HP, 125/250Vac	125V Neon, Red Lens, Black Base, Quick Disconnect	3.09		

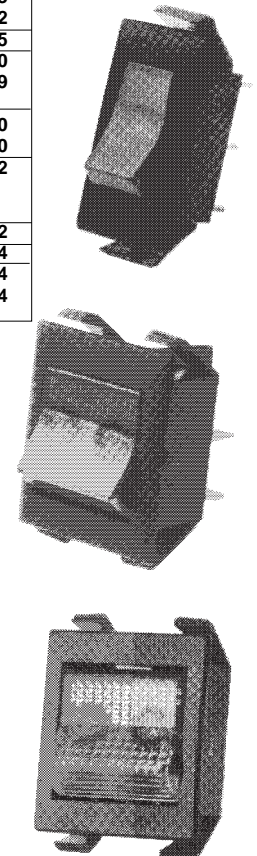

**Heavy Duty AC/DC Switches, 10-14 Amperes**

These heavy duty toggle switches have contacts with a quick-make/quick-break wiping action. The three position switches offer a unique positive center stop feature which assures that the lever cannot be thrown from one side through the center "Off" position without stopping. Used for motor reversing and speed control applications.

PART NUMBER	PRICE	RATING AC / DC	CIRCUIT	ACTION	TERMINATION
7814K2	\$ 70.84	14A, 125V 7A, 250V 3/4HP, 125-250V	DPDT	ON-OFF-ON	SCREW
7815K3	92.84	10A, 125V 5A, 250V	3PDT	ON-OFF-ON	SCREW
7816K2	109.95	10A, 125V 5A, 250V 1/2HP, 125-250V	4PDT	ON-OFF-ON	SCREW

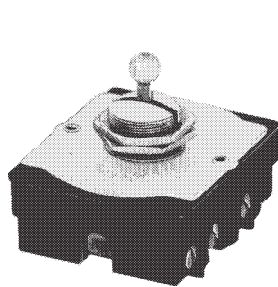

7815K3

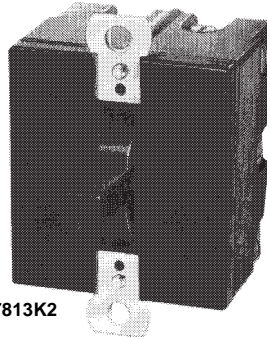

7813K2

**Extra Heavy Duty AC/DC Switches, 10-30 Amperes**

PART NUMBER	PRICE	RATING AC / DC	CIRCUIT	ACTION	TERMINATION
7810K2	\$ 109.47	20A, 125V 10A, 250V	DPDT	ON-OFF-ON	SCREW
7813K2	206.26	30A, 125V 20A, 250V	4PDT	ON-OFF-ON	SCREW

**Industrial Toggles - AC/DC Rated**

Listings are UL recognized and CSA certified.

Quick Make, Quick Break  
Nontearable, Self Cleaning,  
Wiping Action Contacts

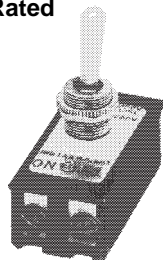

**Heavy Duty AC Rated Switches**

Slow make, slow break, designed specifically for use on ac and low voltage dc applications. Patented interlock mechanism prevents operation of lever through the center position until pressure is momentarily relieved.

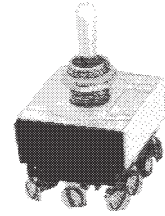

PART NUMBER	PRICE	RATING AC	CIRCUIT	ACTION	TERMINATION
7992K10	\$ 14.30	15A, 125V	2 P.D.T.	ON-OFF-ON	SCREW
7991K10	17.23	10A, 250V	3 P.D.T.		TERMINALS
7990K10	22.08	3/4HP, 250V	4 P.D.T.		

**Designer Line Toggle Switches - General Purpose ac/dc Rated**

Designer Line Toggles are UL recognized and CSA certified. They are available on special order with various lever shapes and colors. Optional colored cap nuts are also available. The switches listed below have a black flat bat lever, 0.671 " long; threaded bushing, 0.468 " - 32 X 0.344 " long.

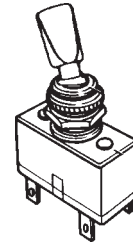

PART NUMBER	PRICE			ACTION	TERMINATION
8280K127C	\$ 2.82			ON-NONE-OFF	Solder Lugs
8282K127C	3.52			ON-NONE-ON	
8381K127C	2.93			ON-NONE-OFF	
8370K127C	4.91			ON-NONE-ON	
8373K127C	5.63			ON-NONE-ON	

**AEROSPACE MIL SPEC TOGGLE SWITCHES**

**Commercial Grade Econoswitch Sealed Toggle Switches**

PART NUMBER	PRICE	RATING AC / DC	CIRCUIT	ACTION	BUSHING LENGTH
7321K3	\$ 4.69	16A, 125V 8A, 250V 1HP 250Vac 1-1/2HP 250Vdc	1PST	ON-NONE-OFF	0.469
7361K5	6.30	20A, 125V 10A, 250V 1HP 250Vac 1-1/2HP 250Vdc	1PST	ON-NONE-OFF	0.469
8690K2	14.17	15A, 125V 10A, 250V	2PDT	ON-NONE-ON	0.469
7320K2	4.43	16A, 125V	2PST	ON-NONE-OFF	0.344
7320K3	4.43	8A, 250V 1HP 250Vac			0.469
7360K7	5.91	20A, 125V 10A, 250V	2PST	ON-NONE-OFF	0.344
7360K8	5.91	1-1/2HP 250Vac 1-1/2HP 250Vdc	2PST	ON-NONE-OFF	0.469
7402K3	10.28	20A, 250V	2PST	ON-NONE-OFF	0.344
7402K4	10.28	2HP 250Vac/dc			0.469

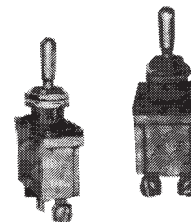

PART NUMBER	PRICE	RATING RESISTIVE	POLES &	ACTION	TERMINATION
8530K1	\$ 14.26	Maintained	THROW S.P.S.T.	ON-OFF-OFF	Screw Terminals
8530K9	14.26	15A, 115V ac		ON-NONE-OFF	
8530K4	14.26	20A, 28Vdc	S.P.D.T.	ON-NONE-ON	
8530K2	14.26	Momentary		MomON-OFF-MomON	
8531K1	20.06	11A, 115Vac		ON-OFF-ON	
8531K9	20.06	15A, 28Vdc	D.P.D.T.	ON-NONE-OFF	
8531K4	20.06		D.P.S.T.	ON-NONE-ON	
8531K2	20.06		D.P.D.T.	MomON-OFF-MomON	

**General Purpose Momentary AC Switches**

7835K11A

**Mounting Means:** Slotted Bushing - 15/32" Dia, 32 Threads/in; .562" long  
**Hardware Supplied** - 1 Hex Nut And 1 Knurl Unassembled  
**Finish:** Tin-Dipped Bushing And Knurled Nut Bright Nickel Buttons  
**Termination:** Solder Terminals

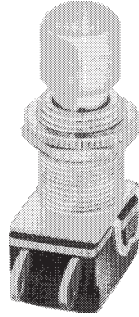

Part Number	Price	Rating AC / DC	Circuit	Action	Button Style
7835K11A	\$5.80	3A, 120V AC	SPST	ON-MOM.OFF	STANDARD
7835K11C	7.76	1A, 250V AC	SPST	ON-MOM.OFF	BLACK SNAP-ON
7835K11D	7.76	1/10 HP, 120V AC	SPST	ON-MOM.OFF	RED SNAP-ON
7836K11A	5.80	AC	SPST	OFF-MOM.ON	STANDARD
7836K11C	7.69		SPST	OFF-MOM.ON	BLACK SNAP-ON
7836K11D	7.69		SPST	OFF-MOM.ON	RED SNAP-ON

**Heavy Duty AC Only Rotary Switches**

These switches have a slow make / slow break switching mechanism with large butt type contacts. High current switching capability allows them to be used in power applications such as gas pumps, and heating and cooling ventilation systems.

**Contact Material:** Moveable - Silver Cadmium Oxide  
**Shaft Type:** 1/4" Diameter. "D" slotted and screw driver type  
**Mounting Means:** Non-slotted Bushing - 3/8" Dia. 24 Threads per inch; .218" long  
**Hardware Supplied** - 1 Hex Nut and 1 Flat Washer unassembled  
**Finish:** Bright Nickel Shaft, Tin Dipped Sleeve and Hardware

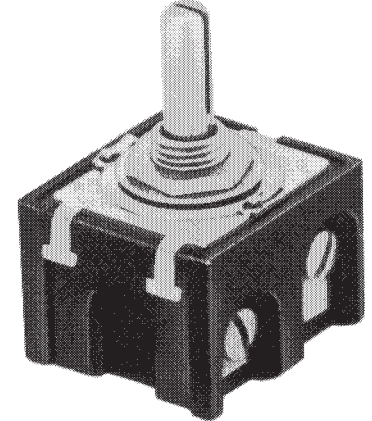

UL Listed

Part Number	Price	Rating AC	Circuit	Switch Position	Shaft Type	Termination
7841K1	\$37.13	20A, 120V AC 5A*L", 120V AC 20A, 240V AC 1HP, 120V AC 2HP, 240V AC	DPST	2 Position Off - On Clockwise On	Slotted Length .687" Flat Depth .046"	Screw
7844K1	37.91	20A, 120V AC 20A, 240V AC 1HP, 120V AC	Two Separate Circuits	3 Position 1-Off-2	"D" Type Length .687" Flat Depth .062"	Screw

**Double Action AC/DC Switches, 6-20 Amperes**

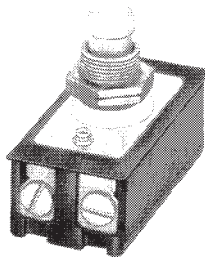

7229K2

The unique Arrow Hart alternate action design Push On-Push Off  
**Mounting Means:** Slotted Bushing - 15/32" Dia .32 Threads inch; .562" long  
**Hardware Supplied** - 1 Hex Nut And 1 Knurled Nut, Unassembled  
**Finish:** Tin-Dipped Bushing And Knurled Nut Bright Nickel Buttons  
**UL Listed**

Part Number	Price	Rating AC / DC	Circuit	Push Action	Termination
7207K104	\$ 7.04	3A, 250V	SPST	ON / OFF	WIRE LEADS
7208K104	6.28		SPST	ON / OFF	SCREW
7227K2	9.67	16A, 125V 8A, 250V 1 HP, 125-250V	DPST	ON / OFF	SCREW
7229K2	10.34	20A, 125V 10A, 250V 11/2 HP, 125-250V	DPST	ON / OFF	SCREW

**Snap on Push-button Caps**

Optional snap on Push-button Caps are made of plastic and are ordered separately for user assembly.

Part Number	Price	Description	Button Dia., In.
8980P32	\$0.71	BLACK MOLDED SNAP ON CAP	0.625
8980P33	0.71	RED MOLDED SNAP ON CAP	0.625

**Mounting Hardware**

All sleeve-mounted switches are furnished with two hex type mounting nuts. One nut is mounted behind the panel to prevent the bushing from being distorted if the front panel nut is over tightened.

C

Part Number	Price	Description	Thread or I.D., Inches	Material	Finish
15-192	\$0.10	Std. Hex Nut	15/32-32	Steel	Chromate
16-886	0.10	Lockwasher	15/32	Bronze	Tin Dipped
29-761-5	0.10	Std. Locating Ring	15/32	Brass	Tin Dipped
30-5632-4	0.13	On - Off Dial	15/32	Brass	Tin Dipped

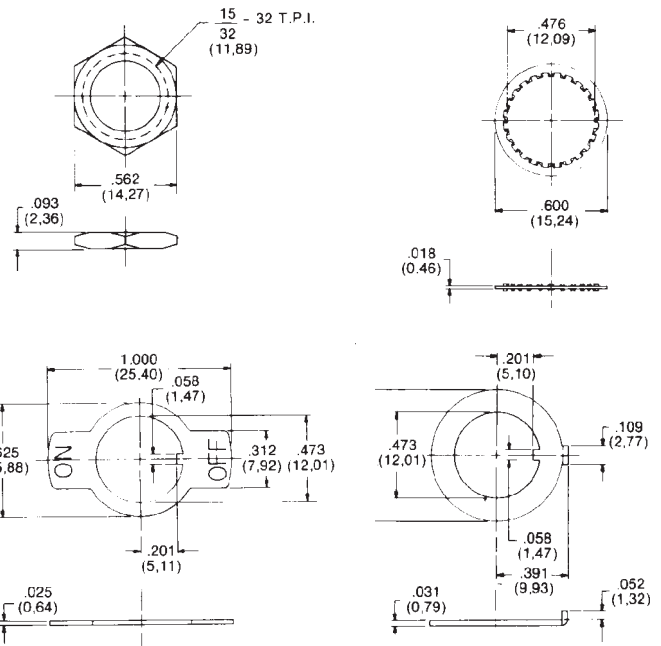

**Miniature Snap in Lighted and Non-Lighted Rocker Switches Elite Series**

The Elite Mini Rocker Switch series combines quality and durable construction into a compact package that fits standard industry panel cut outs.

**Mounting Means:** Snap in rectangular cutout:

.508" Wide x .780" Long

**Minimum Panel Thickness:** .030"

**Maximum Panel Thickness:** .118"

**NON- LIGHTED**

Part Number	Nominal Rating Amperes	Poles And Throw	Action With Lever		Description	Price
			Up	Down		
<b>E110M13J</b>	8A, 1/4HP, 125Vac	SPST			Matte Finish, Black Base; Red Lever, Quick Disconnect	<b>\$0.89</b>
<b>E120M11J</b>	6A, 1/2HP, 250Vac	DPST	ON	OFF	Matte Finish, Black Base; Black Lever, Quick Disconnect	<b>1.19</b>
<b>E120M11J01</b>					Matte Finish, Black Base; Red Lever, Quick Disconnect with ( I - O ) Legend	<b>1.78</b>
<b>E20M11J</b>	10A, 1/4HP, 125Vac 10A, 1/2HP, 250Vac	SPST			Matte Finish, Black Base; Black Lever, Quick Disconnect	<b>0.89</b>

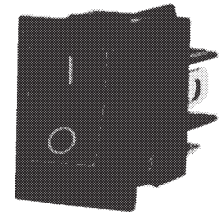

E120M11J01

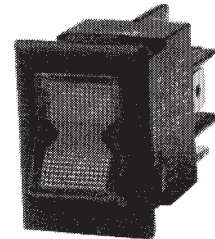

E120MR11J

**LIGHTED**

Part Number	Nominal Rating Amperes	Poles And Throw	Action With Lever		Description	Price
			Up	Down		
<b>E110MR11J</b>	8A, 1/4HP, 125Vac	SPST	ON	OFF	125V Neon, Red Lens, Matte Finish, Black Base, Quick Disconnect	<b>\$1.97</b>
<b>E120MR11J</b>	6A, 1/2HP, 250Vac	DPST				<b>2.19</b>



## X-ON Electronics

Largest Supplier of Electrical and Electronic Components

*Click to view similar products for [Toggle Switches](#) category:*

*Click to view products by [Eaton](#) manufacturer:*

Other Similar products are found below :

[A19HV](#) [8A1-C-222](#) [60012L](#) [6006L](#) [6663](#) [7101MD9V30GE](#) [7101SPDV30BE](#) [7103SDV30BE](#) [7105D](#) [7108P3YAV2BE](#) [71YY50282](#)  
[7201MD9AVBE](#) [7301K38](#) [7306K36](#) [7310K36](#) [7314K36](#) [7506K4](#) [7592K6](#) [7691K14](#) [7700K1](#) [8396K108](#) [8824K14](#) [8828K13](#) [G2VX](#) [G3VX](#)  
[PS83-121G](#) [A101MD9AB04](#) [A101SD9AB04](#) [A101SDCQ04](#) [A103SD9AQ04](#) [A107TZB04](#) [A123P32YZQ](#) [A123S1YZG](#) [A127S1YCQ](#) [1-](#)  
[1825192-0](#) [A131S1YZQ](#) [A201SCWZB04](#) [A207SYCB04](#) [A208J61ZQ0004](#) [A221K12KAG](#) [A221S1YZQ](#) [A221T1TCQ](#) [A232K12KZQ](#)  
[A232M1YCQ](#) [A323S1CWZQ](#) [A423S1CWZG-M8](#) [A423S1YZQ](#) [12149A-3V](#) [12156AX408](#) [12147AGKX679](#)