

Specification

For 5050 Three Chips Neutral White Color Top LED

Part No: OF-SMD5060NW-H



Technical Datasheet

5050 is thermal management characteristic is better than other LED Solutions. By package SMD design and good thermal emission material.



According to these advantages, it enables to apply various lighting applications and design solution, automotive lighting, and large size LCD backlight etc.

Applications:

- Backlight for LCD Switch and Display
- Decorative Lighting
- General Lighting
- Automotive Interior Lighting
- General Use

Features

- PLCC LED dimensions: 5.0(L) x 5.0(W) x 1.6(H) mm
- High intensity
- Extremely wide view angle
- Anti-electrostatic tape package
- Reliable and stable

Package Dimension

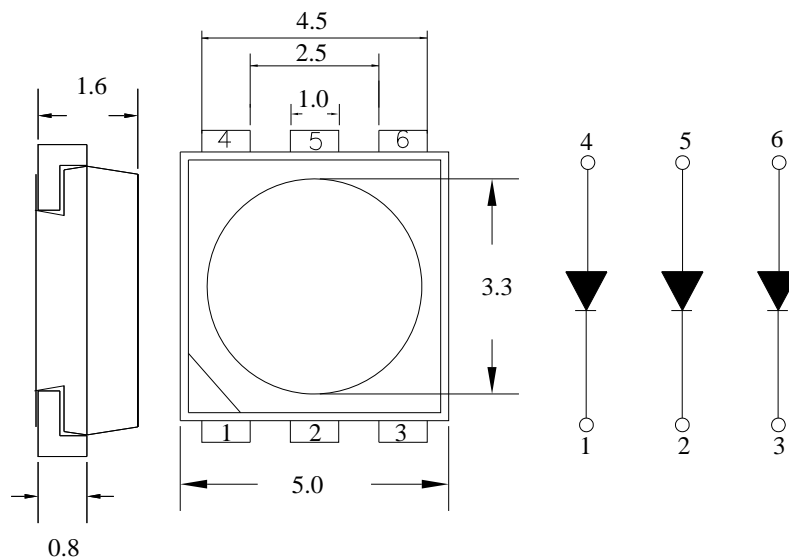

Notes:

1. All dimension units are in millimeters
2. All dimension Tolerance is ± 0.25 mm unless otherwise noted.

Absolute Maximum Ratings at Ta=25°C

| Parameter | Symbol | Value | Unit |
|--|-----------------|-----------------|------|
| Power dissipation | Pd | 200 | mW |
| Continuous Forward Current | I _F | 60 | mA |
| Peak Forward Current (1/10 Duty Cycle, 0.1ms Pulse Width) | I _{FP} | 50 | mA |
| Reverse Voltage | V _R | 5 | V |
| Electrostatic Discharge (HBM) | ESD | 1000 | V |
| Operating Temperature Range | Topr | -25 to +85 | °C |
| Storage Temperature Range | Tstg | -40 to +100 | °C |
| Lead Soldering Temperature | Tsol | 260(for 5 sec) | °C |

Electrical Optical Characteristics at Ta=25°C

| Parameter | Symbol | Min. | Typ. | Max. | Unit | Test Condition |
|--------------------|-------------------|------|------|------|------|--------------------------------|
| Luminous Intensity | I _v | 5800 | --- | 8400 | mcd | I _F = 60mA (Note 8) |
| Ref. Luminous Flux | Φ _v | 18 | 20 | --- | Lm | I _F = 60mA |
| Viewing Angle | 2θ _{1/2} | --- | 120 | --- | Deg | I _F = 60mA |
| Forward Voltage | V _F | 2.8 | --- | 3.4 | V | I _F = 60mA |
| Reverse Current | I _R | --- | --- | 30 | μA | V _R = 5V |

Notes:

1. WW maintains a tolerance of ±10% on flux and power measurements.
2. λd ±1nm; X.Y Tolerance each Bin limit is ± 0.01
3. A tolerance of ±0.1V on forward voltage measurements
4. View Angle maintains a tolerance of ±20°
5. Specifications are subject to change without notice.
6. These products are sensitive to static electricity; high standard of care must be fully taken when handling them. Particularly if an over-voltage that exceeds the Absolute maximum Rating of these products were applied, the overflow energy will cause damage to and possibly result in destruction of these products. Buyer shall take absolute secure countermeasures against static electricity and surge when handling these products.
7. Luminous intensity is measured with a light sensor and filter combination that approximates the CIE eye-response curve.θ_{1/2} is the off-axis angle at which the luminous intensity is half the axial luminous intensity.
8. It uses many parameters that correspond to the CIE 1931 2° X, Y, and Z are CIE1931 2° values of Red, Green and Blue content of the measurement.

Typical Characteristics

Typical Electrical/Optical Characteristic Curves

Fig.1 IF-VF(Ta=25°C)

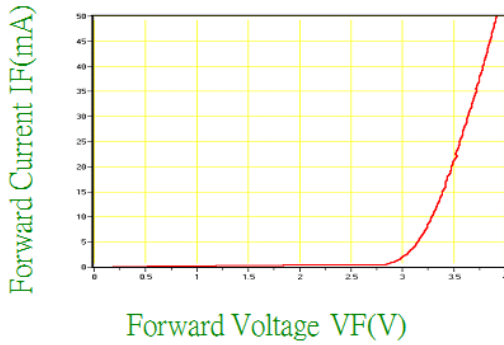

Fig.2 Relative Luminous Intensity-IF (Ta=25°C)

(25°C Ambient Temperature Unless Otherwise Noted)

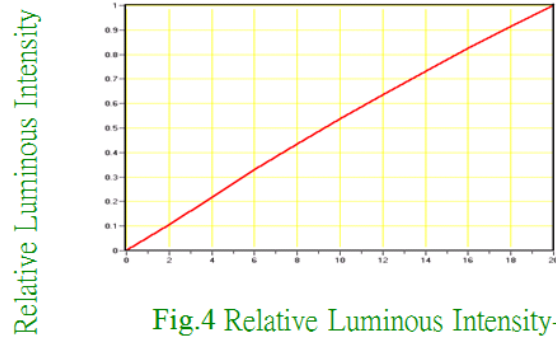

Fig.3 Wavelength Characteristics (Ta=25°C)

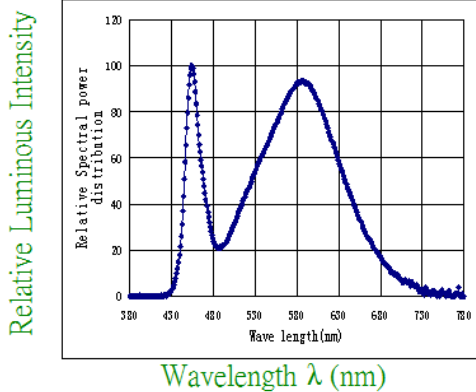

Fig.4 Relative Luminous Intensity-Ta

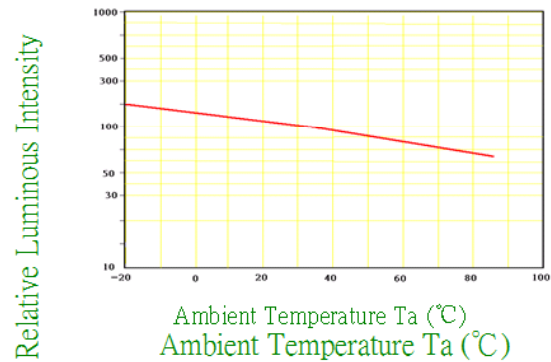
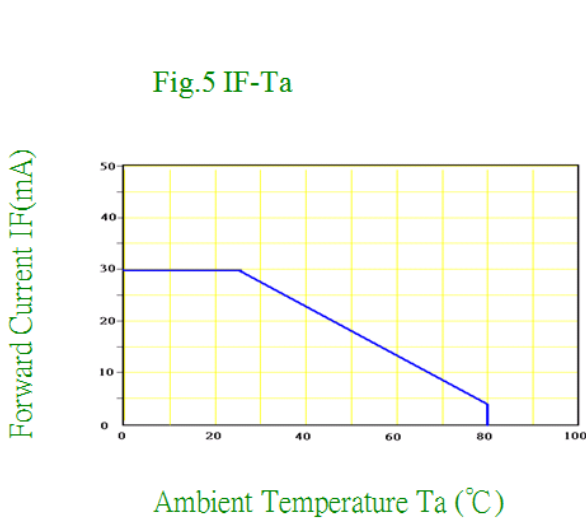
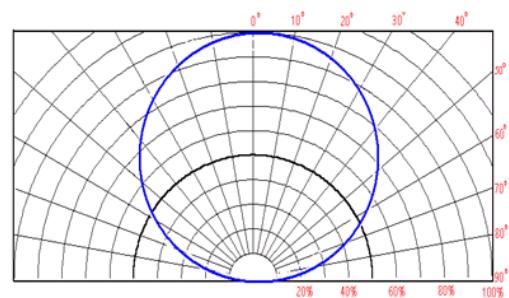

Fig.5 IF-Ta



Directive Characteristics (Ta=25°C)



Chromaticity Coordinates Specifications for Bin Grading:

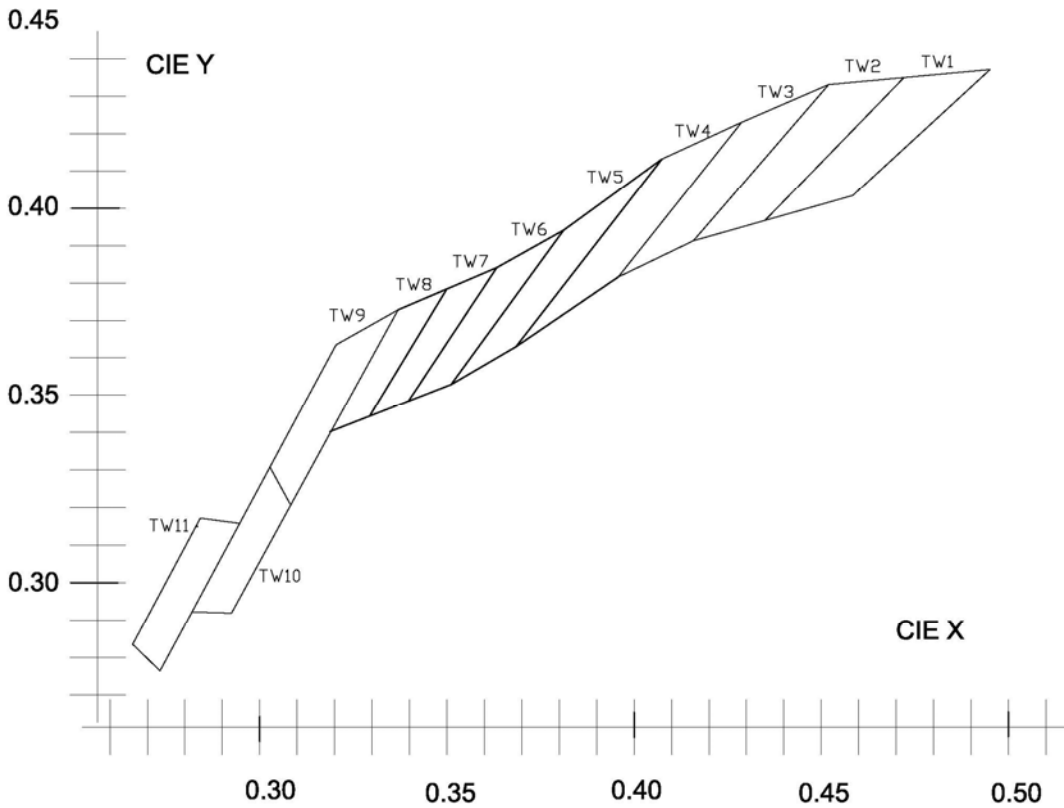

| Color Ranks | | Warm White | | | | White | | | | | |
|-------------|---|------------|--------|--------|--------|-------|---|--------|--------|--------|--------|
| TW1 | X | 0.4395 | 0.4585 | 0.4952 | 0.4721 | TW7 | X | 0.3276 | 0.3361 | 0.3581 | 0.3476 |
| | Y | 0.3914 | 0.3935 | 0.4272 | 0.4251 | | Y | 0.3317 | 0.3329 | 0.3661 | 0.3645 |
| TW2 | X | 0.4231 | 0.4395 | 0.4721 | 0.452 | TW8 | X | 0.319 | 0.3276 | 0.3476 | 0.337 |
| | Y | 0.3896 | 0.3914 | 0.4251 | 0.4231 | | Y | 0.3305 | 0.3317 | 0.3645 | 0.363 |
| TW3 | X | 0.4022 | 0.4159 | 0.4447 | 0.4287 | TW9 | X | 0.3083 | 0.3029 | 0.3245 | 0.3205 |
| | Y | 0.3798 | 0.3814 | 0.4147 | 0.4131 | | Y | 0.3111 | 0.3209 | 0.3408 | 0.3541 |
| TW4 | X | 0.3815 | 0.3958 | 0.422 | 0.4072 | TW10 | X | 0.2865 | 0.2924 | 0.3029 | 0.3083 |
| | Y | 0.3695 | 0.3717 | 0.4048 | 0.4029 | | Y | 0.2903 | 0.2819 | 0.3209 | 0.3111 |
| TW5 | X | 0.3573 | 0.3684 | 0.3944 | 0.3812 | TW11 | X | 0.2661 | 0.2734 | 0.2907 | 0.2841 |
| | Y | 0.3513 | 0.353 | 0.3861 | 0.3842 | | Y | 0.2737 | 0.2664 | 0.2978 | 0.3072 |
| TW6 | X | 0.3417 | 0.3511 | 0.3752 | 0.3635 | | | | | | |
| | Y | 0.3415 | 0.3429 | 0.3759 | 0.3742 | | | | | | |

Notes:

*Customer can choose any group

*Tolerance of Color Temperature is upper 9000K \pm 500K / 9000K-5000K \pm 100K / below 5000K \pm 50K

*X and Y are CIE1931; Color Coordinates Measurement allowance is \pm 0.01

Reliability:

1) Test Items and Results

| No. | Test Item | Standard Test Method | Test Conditions | Note | Number of Damaged |
|-----|------------------------------|--------------------------|--|------------|-------------------|
| 1 | Steady State Operating Life | JEITA ED-4701 100 103 | If=60mA Ta=25°C | 1000hrs | 0/22 |
| 2 | Low Temperature Storage | JEITA ED-4701 200 202 | Ta=-40°C | 1000hrs | 0/22 |
| 3 | High Temperature Storage | JEITA ED-4701 200 201 | Ta=100°C | 1000hrs | 0/22 |
| 4 | Temperature Humidity Storage | JEITA ED-4701 100 103 | Ta=60°C RH=90% | 1000hrs | 0/22 |
| 5 | Thermal Shock | JEITA ED-4701 300 307 | 0°C ~ +100°C 5min~ 15sec ~ 5min | 10 cycles | 0/22 |
| 6 | Temperature Cycle | JEITA ED-4701 100 105 | H: +100°C 30min. ∫: +25°C 5min. L: -40°C 30min | 100 cycles | 0/22 |
| 7 | Solder Heat | JEITA ED-4701 300 301 | Tsld=260°C, 10sec (Max.) | 2 times | 0/22 |

Failed Conditions

| Item | Symbol | Test Condition | Min | Max |
|--------------------|--------|----------------|-------------|------------|
| Forward Voltage | Vf | If=60mA | -- | *U.S.L×1.1 |
| Reverse Current | Ir | Vr=5V | -- | *U.S.L×2.0 |
| Luminous Intensity | Iv | If=60mA | **L.S.L×0.7 | -- |

*U.S.L.:Upper Standard Level

** L.S.L.:Lower Standard Level

Bin Range

Luminous intensity

| Bin Code | Min. (mcd) | Max. (mcd) |
|----------|------------|------------|
| 17 | 4000 | 4800 |
| 18 | 4800 | 5800 |
| 19 | 5800 | 7000 |
| 20 | 7000 | 10000 |

Dimensions for Tape

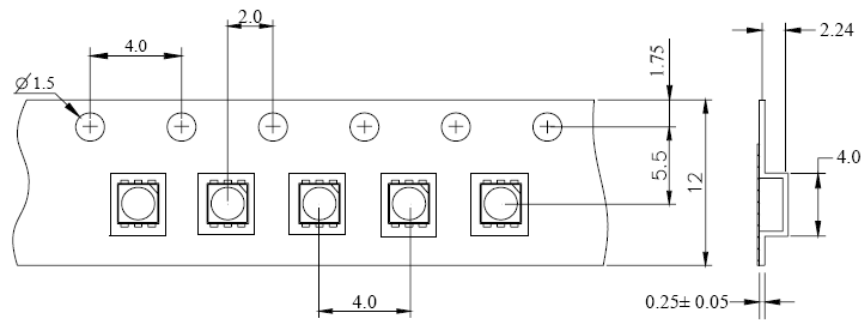

Dimensions for Reel

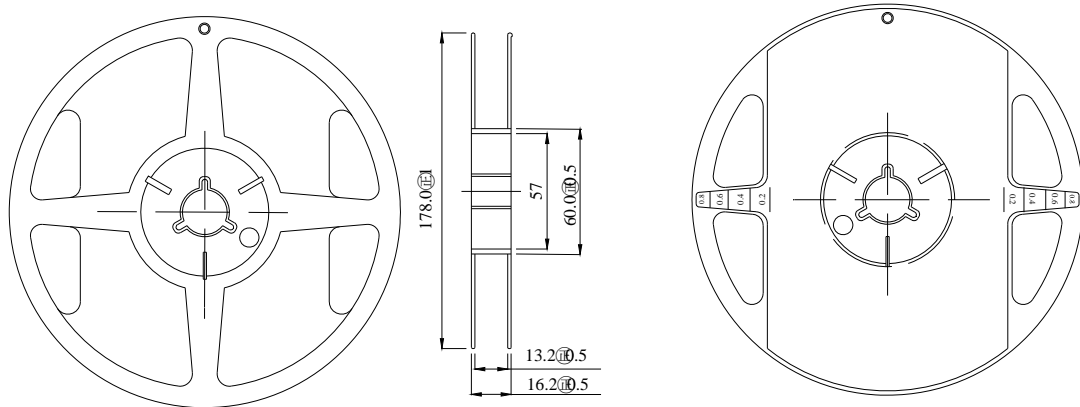

Notes:

1. All dimensions are in mm, tolerance is ± 2.0 mm unless otherwise noted.

Moisture, anti-static vacuum sealed packages

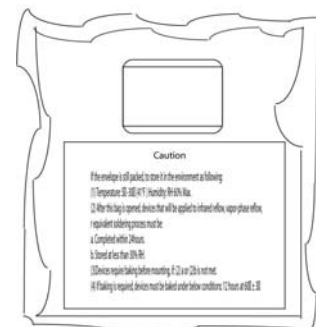
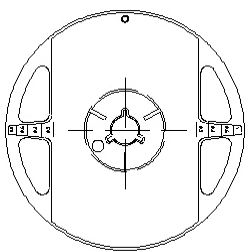

Notes:

- All dimensions are in mm, tolerance is ± 2.0 mm unless otherwise noted.

PRECAUTION IN USE

Storage

Recommended storage environment

Temperature: 5°C ~ 30°C (41°F ~ 86°F)

Humidity: 60% RH Max.

Recommend the use of drying cabinet storage

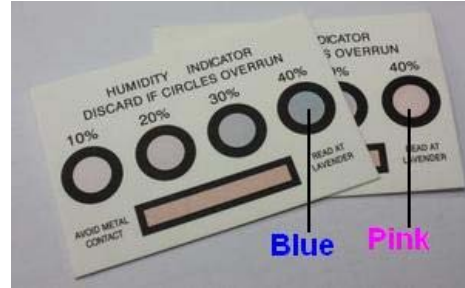

Use

Please check the Humidity indicator card after opening of sealed vapor/ESD (Picture 1.) If the 40% circle color is still blue, the product could normal use. Otherwise, 40% circle color is pink; please follow below Baking treatment before normal use. Baking treatment : Open-static bag, the product and reel dial out from the Static bag, and then 75±5°C for 8 hours baking treatment.

Remaining product be sealed in time, recommend storage in dry cabinet storage. It must be baking treatment when using the remaining product.

Handling Precautions

Compare to epoxy encapsulant that is hard and brittle, silicone is softer and flexible. Although its characteristic significantly reduces thermal stress, it is more susceptible to damage by external mechanical force . As a result,

1. Handle the component along the side surface by using forceps or appropriate tools.
2. Do not directly touch or handle the silicone lens surface. It may damage the internal circuitry
3. Do not stack together assembled PCBs containing LEDs. Impact may scratch the silicone lens or damage

Soldering

A. Reflow Process

| Reflow Soldering | | |
|------------------|--------------------------------|--------------------------------|
| | Lead Solder | Lead – free Solder |
| Pre-heat | 120~150°C | 180~200°C |
| Pre-heat time | 120sec. Max. | 120sec. Max. |
| Peak temperature | 240°C Max. | 260°C Max. |
| Soldering time | 10sec. Max. | 0sec. Max. |
| Condition | refer to Temperature-profile 1 | refer to Temperature-profile 2 |

After reflow soldering rapid cooling should be avoided.

[Temperature-profile (Surface of circuit board)] Use the conditions shown to the under figure.

< 1 : Lead Solder >

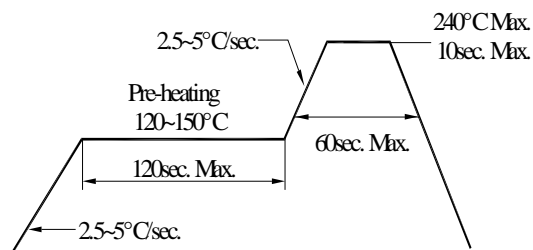

< 2 : Lead-free Solder >

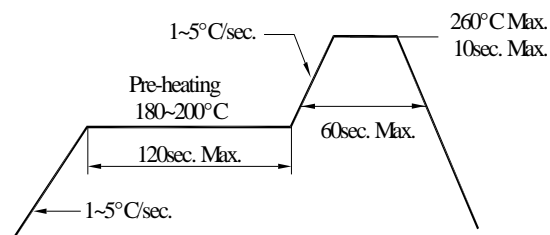

B. Manual Soldering Process

| Hand Soldering | |
|----------------|-------------------------------|
| Temperature | 350°C Max. |
| Soldering time | 3sec. Max. (one time only) |

- a. For prototype builds or small series production runs it is possible to place and solder the LED by hand.
- b. Dispense thermal conductive glue or grease on the substrates and follow its curing specifications. Gently press LED housing to closely connect LED and substrate.
- c. It is recommended to hand solder the leads with a solder tip temperature of 280°C for less than 3 second, at a time with a soldering iron of less than 25W. Solder at intervals of two seconds or more.
- d. Take caution and be aware that damaged products are often a result of improper hand soldering technique.

Rework

1. Customer must finish rework within 5 sec under 260°C
2. The head of iron cannot touch the resin
3. Twin-head type is preferred.

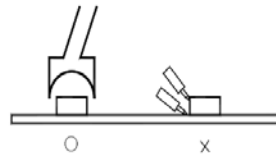

Cleaning :

The conditions of cleaning after soldering:

An alcohol-based solvent such as Isopropyl Alcohol(IPA) is recommended.

Temperature Time:<50°C*30sec,or <30°C*3min

Ultra sonic cleaning:<15W/bath; Bath volume:1liter max.

Curing:100 max,<3min

Cautions of Pick and Place:

It should be avoided to load stress on the resin during high temperature.

Avoid rubbing or scraping the resin by any object.

Electric-static may cause damage to the component. Please confirm that the equipment is grounding well. Using an ionizer fan is recommended.

Cautions of Design and Applications:

It should be done to connect with a current-limiting serial resistor. Avoid to drive reverse voltage over the specifications on LED when ON/OFF. Any application should refer to the specifications of absolute maximum ratings.

The dimensions of the recommended soldering pattern may not meet every users. Please confirm and study before designing the soldering pattern in order to obtain the best performance of soldering.

Do not contact with any component on the assembly board.

Static Electricity:

These products are so sensitive to static electricity charge so that all equipment and machinery must be properly grounded and it is recommended to use a wristband or anti-electrostatic glove when handling the SMD LED.

Particularly if any over-current and over-voltage which exceed the Absolute Maximum Ratings of LED applied, the more energy may cause damage or possibly result in electrical destruction of the Products.

A protection design should be installed in the LED driving circuit, which does not exceed the max. rating for surge current during on/off switching.

A tip if soldering iron is requested to be grounded .An ionizer should be installed when risk of static generation is high.

If the countermeasures mentioned above are implemented, LED can work well.

Users are required to check those countermeasures when problems occur by static electricity charge

Other:

Damaged SMD LED will show unusual characteristics such as leak current remarkably low current. Increase, turn-on voltage becomes lower and the SMD LED get unlighted at low current.

In automatic mounting of the SMD LEDs on printed circuit boards, any bending and pulling forces or shock against the SMD LEDs shall be kept min. to prevent them from expanding or electrical failures and mechanical damages of the devices.

Illustration & Application:

The SMD LED taping is much smaller than leaded components, thus enable smaller size, applications, etc. higher packing density, reduced storage space and finally smaller equipment board to be obtained. Besides, lightweight makes them ideal for miniature

The products described in this brochure are intended only for standard applications or general electronic equipment such as :

1. Telecommunication: indicator and backlight in telephone and fax.
2. Automotive: backlight in dashboard and switch.
3. LCD: Flat backlight for LCD, switch and symbol.

Notes for designing:

Care must be taken to provide the current limiting resistor in the circuit so as to drive the LEDs within the rated figures. Also, caution should be taken not to overload LEDs with instantaneous voltage at the turning ON and OFF of the circuit.

When using the pulse drive care must be taken to keep the average current within the rated figures. Also, the circuit should be designed so as be subjected to reverse voltage when turning off

X-ON Electronics

Largest Supplier of Electrical and Electronic Components

Click to view similar products for [High Power LEDs - White category](#):

Click to view products by [Optoflash manufacturer](#):

Other Similar products are found below :

[G42180-08](#) [B42180-08](#) [STW8Q2PA-R5-HA](#) [SZ5-M1-W0-00-V3/W2-AA](#) [LTPL-P00DWS57](#) [LZP-D0WW00-0000](#) [CLM-9-30-90-36-AC32-F4-3](#) [SZ5-M1-WW-C8-V1/V3-FA](#) [BXRC-27E2000-D-73](#) [BXRC-27G2000-D-73](#) [BXRC-30E1000-D-73](#) [BXRC-30G2000-D-73](#) [BXRC-40E1000-D-73](#) [BXRE-30G2000-B-73](#) [BXRE-30G2000-C-73](#) [BXRE-50C2001-C-74](#) [CXM-22-27-80-54-AC30-F4-3](#) [XHP50B-00-0000-0D0UH245G](#) [XHP50B-00-0000-0D0UH240G](#) [XHP50B-00-0000-0D0UG227H](#) [XHP50B-00-0000-0D0HJ245G](#) [MP-5050-8100-27-80](#) [MP-5050-6100-65-80](#) [MP-5050-6100-50-80](#) [MP-5050-6100-40-80](#) [MP-5050-6100-30-80](#) [CXM-22-30-80-54-AC30-F4-3](#) [LTW-2835SZK57](#) [BXEM-50C0000-0-000](#) [WW-WNA30TS-U1\(M1\)](#) [KW CSLPM2.CC-8L8M-4L8N](#) [KW CSLPM2.CC-8L8M-4O9Q](#) [KW DPLS32.SB-6H6J-E5P7-EG-Z264](#) [L1V1-507003V500000](#) [CXM-22-35-80-36-AC10-F3-3](#) [KW3 CGLNM1.TG-Z6QF6-EBVFFCBB46-DFGA](#) [JB5630AWT-H-H65EA0000-NZ000001](#) [XHP50B-00-0000-0D0UG430H](#) [CXM-22-35-90-54-AC40-F5-3](#) [CXM-22-35-80-54-AC40-F5-3](#) [OSM51206E1N-0.8T](#) [OSW43020C1C](#) [MP161611032290](#) [MP-1616-2103-50-90](#) [KW CULPM1.TG-Z6RF7-ebvFfcbB46-65G5](#) [KW DMLS33.SG-Z6M7-EBVFFCBB46-8E8G-700-S](#) [XPGDWT-B1-0000-00EEA](#) [XHP70B-00-0000-0D0BP450E](#) [KW DMLN33.SG-7J7K-EBVFFCBB46-8E8G-200-S](#) [ASMT-MW05-NMNS1](#)