



# WIDE24 G/W

## WIDE, ALUMINIUM, SURFACE PROFILE

## SZEROKI, ALUMINIOWY PROFIL NAWIERZCHNIOWY



- lighting and decorative profile
- possibility of installing 3 8 mm LED strips
- Slick socket
- maximum LED strip width: 24 mm
- profil oświetleniowo-dekoracyjny
- możliwość zastosowania równoległe 3 taśm 8 mm
- gniazdo z funkcją Slick
- maksymalna szerokość taśmy LED: 24 mm



## SIMILAR IN THE OFFER / PODOBNE W OFERCIE

  
SURFACE10  
BC/UX

  
UNI12  
BCD/U

  
BEGTON12  
J/S

  
SURFACE14  
EF/TY

  
LINEA20  
EF/TY

  
VARIO30-02  
ACD-9/TY

  
VARIO30-01  
ACD-9/TY

 TOPMET®

# WIDE24 G/W

**G** slide cover  
klosz G wsuwany

**W** cone W flexible mounting plate  
uchwyt W sprężysty cone

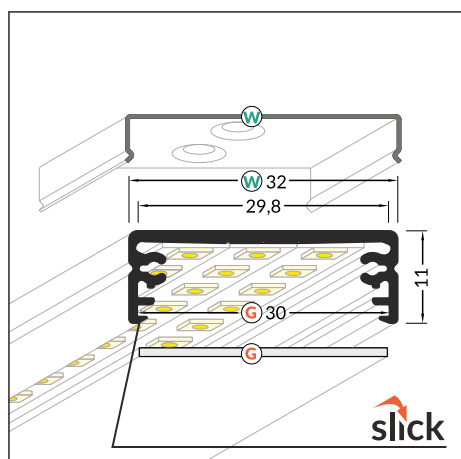
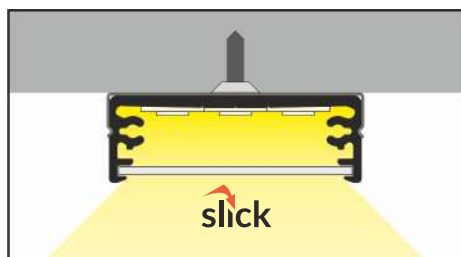
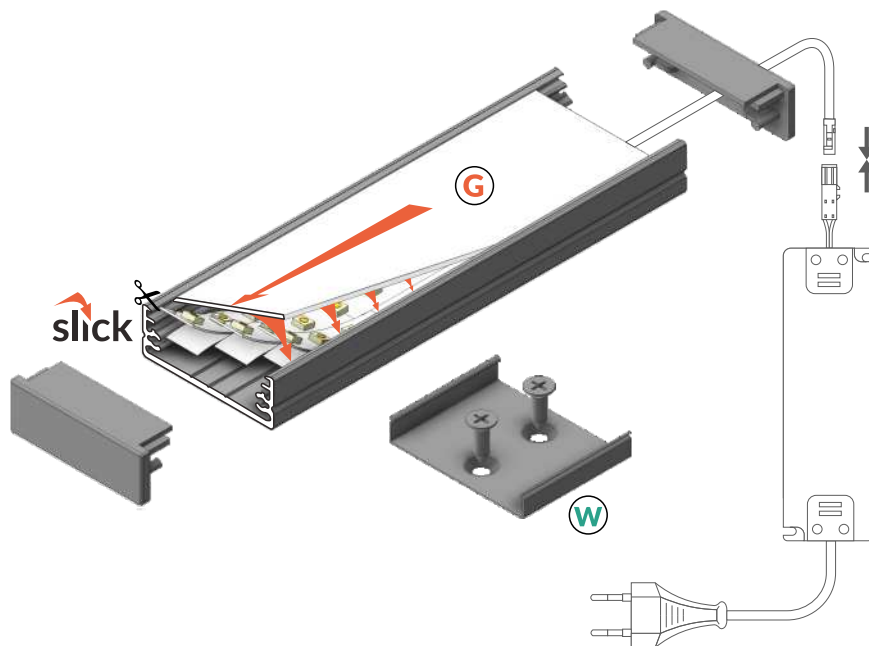

 max 24 mm

 surface  
nawierzchniowy

INDEX = 1 pc, length 2000 mm  
package = 10 pcs  
INDEKS = 1 szt., długość 2000 mm  
opakowanie = 10 szt.

 white painted  
biały malowany  
84030001

 anodized  
anodowany  
84030020

 black anodized  
czarny anodowany  
84030021

 raw aluminium  
surowe aluminium  
84030000

Available lengths / Dostępne długości  
1000 mm, 2000 mm, 3000 mm, 4000 mm



## COVERS / KLOSZE

**G slide cover**  
colours: transparent, frosted, white  
material: PC, PP, PP

klosz **G** wsuwany  
kolory: transparentny, szron, mleczny  
materiał: PC, PP, PP



**Note!** Dimensions of the space to install LED source  
**Uwaga!** Wymiary przestrzeni do zamontowania źródła LED

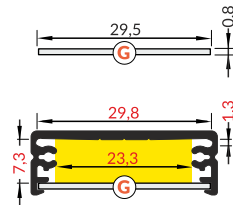

INDEX = 1 pc, length 2000 mm  
package = 10 pcs  
INDEKS = 1 szt., długość 2000 mm  
opakowanie = 10 szt.

**G transparent / G transparentny**  
84070016

**G frosted / G szron**  
84070039

**G white / G mleczny**  
84070038

## ENDINGS / ZAŚLEPKI

**WIDE24 ending**  
colours: white, silver, black, grey  
material: ABS  
zaślepka WIDE24  
kolory: biały, srebrny, czarny, szary  
materiał: ABS

**WIDE24 ending with hole**  
colours: white, silver, black, grey  
material: ABS  
zaślepka WIDE24 z otworem  
kolory: szary, czarny, biały, srebrny  
materiał: ABS

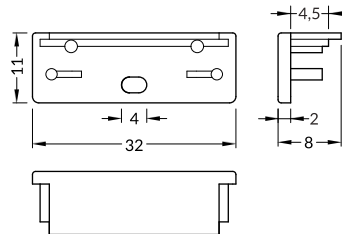

INDEX = 1 set  
package of 10 sets = 20 pcs  
INDEKS = 1 komplet, opakowanie  
zawiera 10 kompletów = 20 szt.

white  
białe  
with hole z otworem  
84300001 | without hole bez otworu  
84040001

silver  
srebrne  
with hole z otworem  
84300040 | without hole bez otworu  
84040040

black  
czarne  
with hole z otworem  
84300002 | without hole bez otworu  
84040002

grey  
szare  
with hole z otworem  
84300022 | without hole bez otworu  
84040022

## MOUNTINGS / MOCOWANIA

**cone W flexible mounting plate**  
colour: inox  
material: stainless steel

uchwyt **W** sprężysty cone  
kolor: inox  
materiał: stal nierdzewna

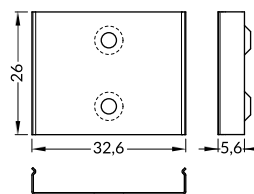
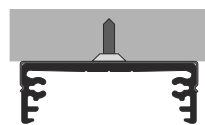

INDEX = 1 set  
package of 10 sets = 20 pcs  
INDEKS = 1 komplet  
opakowanie zawiera 10 kpl = 20 szt.

cone **W** flexible mounting plate  
uchwyt **W** sprężysty cone

white painted  
biały malowany 84510001

inox  
inox 84510019

black painted  
czarny malowany 84510002

**WIDE24 simple holder**  
material: zinc coated steel

uchwyt WIDE24 prosty  
materiał: stal ocynkowana

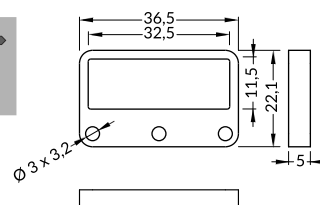
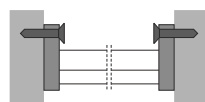

INDEX = 1 set = 2 pcs  
INDEKS = 1 komplet = 2 szt.

simple holder  
uchwyt prosty

zinc coated  
stal ocynkowana  
84220030



## SLING / ZAWIESIE

**SELV sling 50 V 1500**  
colours: white, silver, black

zawiesie SELV 50 V 1500  
kolory: biały, srebrny, czarny

**sling for LED mounting 1500**  
colour: chrome

zawiesie do uchwytu LED 1500  
kolor: chrom



INDEX = 1 set  
INDEKS = 1 zestaw

SELV sling 50 V 1500  
zawiesie SELV 50 V 1500

white  
biały 67120001

silver  
srebrny 67120022

black  
czarny 67120002

sling for LED mounting 1500  
zawiesie do uchwytu LED 1500

chrome  
chrom 67140003



Made in Poland  
Wyprodukowane w Polsce



EU-registered industrial design  
Wzory przemysłowe EU

TOPMET LIGHT Kłósowicz Wiśniewski i Wspólnik Sp. j. ADDRESS: Ostrowska 354, 61-312 Poznań, POLAND  
tel. +48 61 87 27 500, fax. +48 61 87 27 518 biuro@topmet.pl, www.topmet.pl

The catalogue is not an offer under Polish Civil Code regulations. Colours of particular products may vary slightly from colours shown in pictures. The dimensions given are approximate and can not be a reason for complaint. TOPMET Company reserves the right to make technical changes.  
Folder nie stanowi oferty w myśl przepisów Kodeksu Cywilnego. Aktualną ofertę firmy stanowi cennik. Kolory poszczególnych produktów mogą się nieznacznie różnić od kolorów prezentowanych na zdjęciach. Podane wymiary są wymiarami orientacyjnymi i nie mogą stanowić podstawy reklamacji. Firma TOPMET zastrzega sobie prawo do wprowadzania zmian technicznych.

brochure designer • proj. folderu: M. Kędziora, A. Szafran 11.2016. photo • fot. K. Samulska, A. Szafran, L. Wesołowski

# X-ON Electronics

Largest Supplier of Electrical and Electronic Components

*Click to view similar products for [LED Lighting Mounting Accessories](#) category:*

*Click to view products by [Topmet](#) manufacturer:*

Other Similar products are found below :

[3635](#) [PALBF18](#) [C16142\\_HEKLA-SOCKET-K](#) [3SU1900-0BC31-0AA0](#) [3SU1900-0BC31-0NB0](#) [2213118-2](#) [47.319.6380.50](#) [3SU1401-2BB40-1AA0](#) [3SU1401-2BB60-1AA0](#) [1SFA611621R1041](#) [23110040](#) [23120022](#) [23130000](#) [68550022](#) [68550040](#) [70290000](#) [70290022](#) [70290040](#) [70300022](#) [70300040](#) [76620000](#) [76990022](#) [77280022](#) [77980022](#) [77990001](#) [77990002](#) [77990040](#) [83130001](#) [83130040](#) [83150001](#) [83150022](#) [83150040](#) [83980001](#) [83980040](#) [83990001](#) [83990022](#) [83990040](#) [84040022](#) [84510002](#) [86050038](#) [86180003](#) [89080002](#) [89080022](#) [89140002](#) [89980002](#) [89980019](#) [98050040](#) [A1070001](#) [A1070002](#) [A2070001](#)