

■Features

- Top view white LED (5.6x3.0x0.8mm)
- Super high brightness of surface mount LED
- Lead frame package with individual 4 pins
- ESD protection
- Compatible to IR reflow soldering.

■Applications

- General lighting
- Decoration lighting
- Indicator

■Outline Dimension

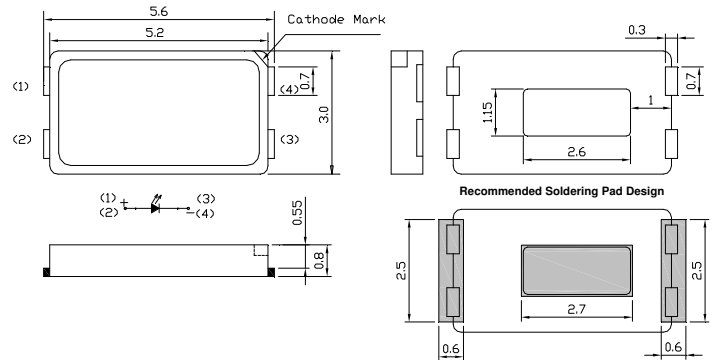

■Absolute Maximum Rating

(Ta=25°C)

Item	Symbol	Value	Unit
DC Forward Current	I_F	150	mA
Pulse Forward Current*	I_{FP}	200	mA
Reverse Voltage	V_R	5	V
Power Dissipation	P_D	540	mW
Operating Temperature	T_{opr}	-30 ~ +85	°C
Storage Temperature	T_{stg}	-40 ~ +100	°C
Lead Soldering Temperature	T_{sol}	260°C/10sec	-

*Pulse width Max 0.1ms, Duty ratio max 1/10

■Directivity

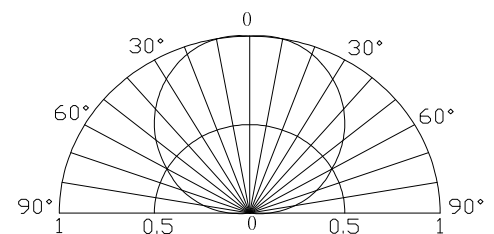

■Electrical -Optical Characteristics

(Ta=25°C)

Part Number	Color	W	V_F (V)			I_R (μA)	Φ_v (lm)			CCT			2θ1/2(deg)
			Min.	Typ.	Max.	Max.	Min.	Typ.	Max.	Min.	Typ.	Max.	Typ.
			$I_F=150mA$			$V_R=5V$		$I_F=150mA$					
OSW35630C1A-150mA	White	W	2.8	3.1	3.6	10	45	-	60	5000K	-	6000K	120
OSM55630C1A-150mA	Warm White	M	2.8	3.1	3.6	10	40	-	55	2800K	-	3500K	120

Note: * V_f tolerance: $\pm 0.05V$

* Luminous flux measurement allowance is: $\pm 10\%$

■ Rank

* Correspondence Table of Luminous Flux

Bin code	Flux(lm)	
	Min	Max
1	30	35
2	35	40
3	40	45
4	45	50
5	50	55
6	55	60
.....

*VF bin Limit (IF=150mA)

Bin code	Min(V)	Max(V)
A	2.8	3.0
B	3.0	3.2
C	3.2	3.4
D	3.4	3.6

■ Chromaticity Diagram

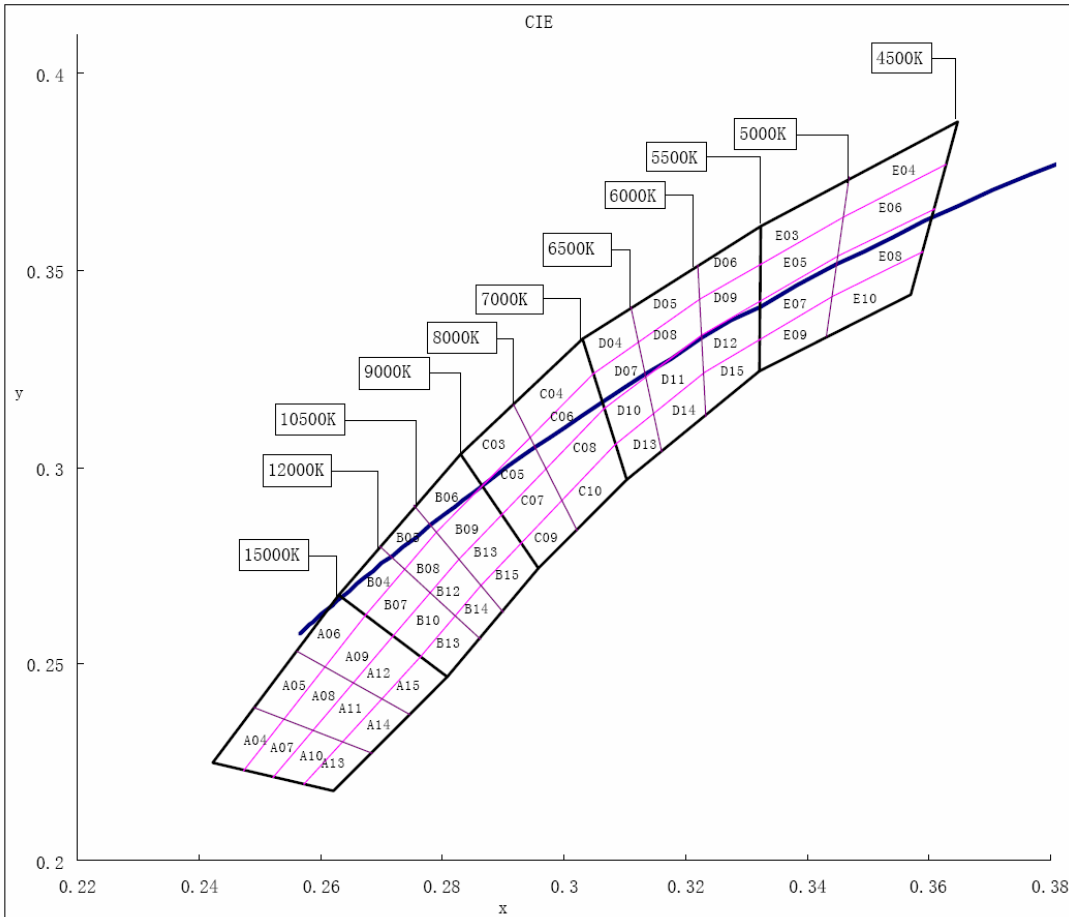

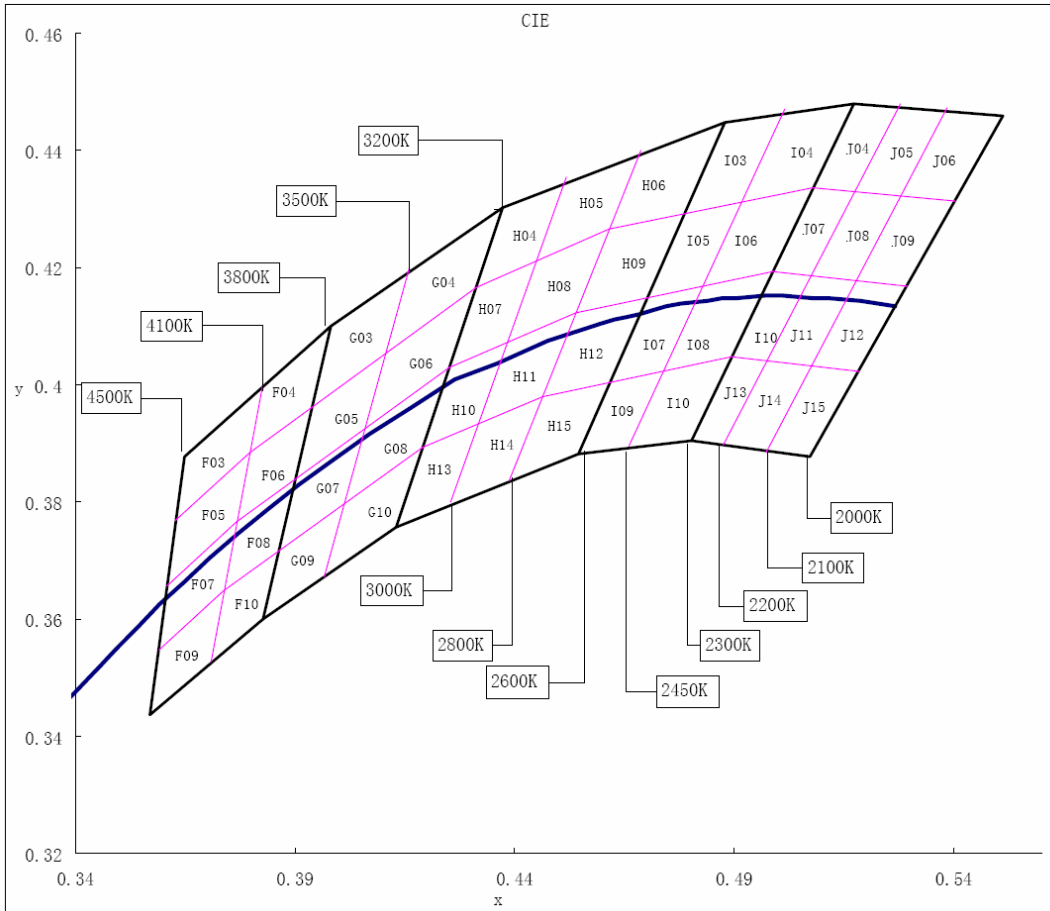

***Bin Range of Chromaticity Coordinates (OSW35630C1A)**

Code	X1	Y1	X2	Y2	X3	Y3	X4	Y4
D06	0.3221	0.3523	0.3324	0.3612	0.3324	0.3520	0.3224	0.3420
D09	0.3224	0.3430	0.3324	0.3520	0.3323	0.3429	0.3228	0.3336
D12	0.3228	0.3336	0.3323	0.3429	0.3323	0.3337	0.3231	0.3243
D15	0.3231	0.3243	0.3323	0.3337	0.3322	0.3245	0.3234	0.3149
E03	0.3324	0.3612	0.3470	0.3738	0.3461	0.3637	0.3324	0.3520
E05	0.3324	0.3520	0.3461	0.3637	0.3452	0.3536	0.3323	0.3429
E07	0.3323	0.3429	0.3452	0.3536	0.3442	0.3435	0.3323	0.3337
E09	0.3323	0.3337	0.3442	0.3435	0.3433	0.3334	0.3322	0.3245

***Bin Range of Chromaticity Coordinates (OSM5630C1A)**

Code	X1	Y1	X2	Y2	X3	Y3	X4	Y4
G04	0.4160	0.4199	0.4373	0.4302	0.4313	0.4166	0.4112	0.4067
G06	0.4112	0.4067	0.4313	0.4166	0.4252	0.4030	0.4063	0.3936
G08	0.4063	0.3936	0.4252	0.4030	0.4192	0.3893	0.4015	0.3804
G10	0.4015	0.3804	0.4192	0.3893	0.4131	0.3757	0.3966	0.3672
H04	0.4373	0.4302	0.4518	0.4354	0.4453	0.4216	0.4313	0.4166
H05	0.4518	0.4354	0.4689	0.4408	0.4614	0.4265	0.4453	0.4216
H07	0.4313	0.4166	0.4453	0.4216	0.4387	0.4077	0.4252	0.4030
H08	0.4453	0.4216	0.4614	0.4265	0.4539	0.4123	0.4387	0.4077
H10	0.4252	0.4030	0.4387	0.4077	0.4322	0.3939	0.4192	0.3893
H11	0.4387	0.4077	0.4539	0.4123	0.4463	0.3980	0.4322	0.3939
H13	0.4192	0.3893	0.4322	0.3939	0.4256	0.3800	0.4131	0.3757
H14	0.4322	0.3939	0.4463	0.3980	0.4388	0.3837	0.4256	0.3800

*If color binning is required, only one color group is allowed for each chip within a reel.

Chromaticity coordinate groups are measured with an accuracy of ± 0.01

*Color coordinate is derived from the CIE 1931 chromaticity.

***Bin rank of VF**

Rank ($I_f=20mA$)	White		
	88T-999	AAA	BBB
DC Forward Voltage(v)	2.9-3.2	3.2-3.4	3.4-3.6

*Forward voltage is measured with an accuracy of $\pm 0.1V$.

Typical Electro-Optical Characteristics Curves

Fig.1 Relative Luminous Intensity VS. Wavelength

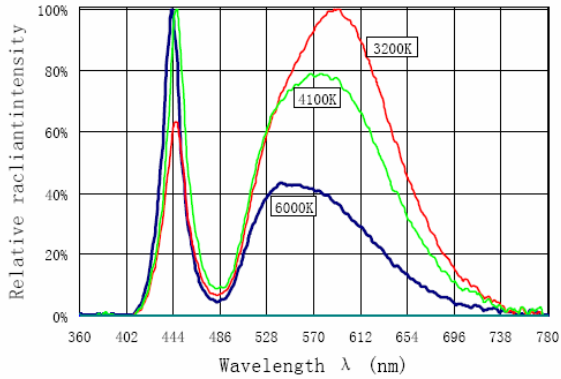

Fig.2 Forward current vs. Forward voltage

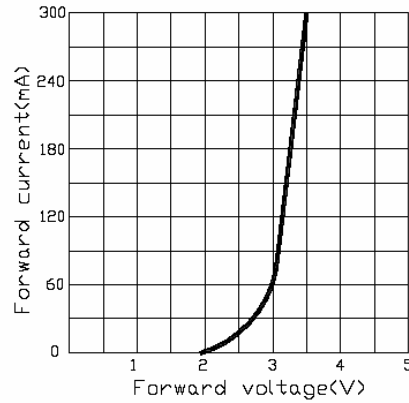

Fig.3 Forward current derating curve vs. Ambient temperature

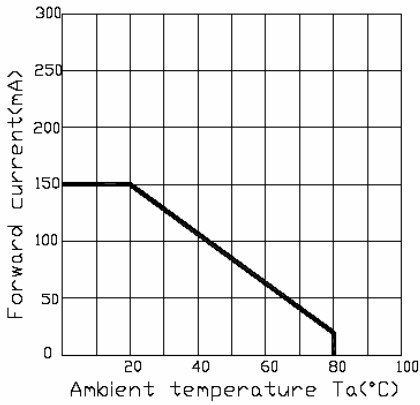

Fig.4 Relative luminous intensity vs. Forward current

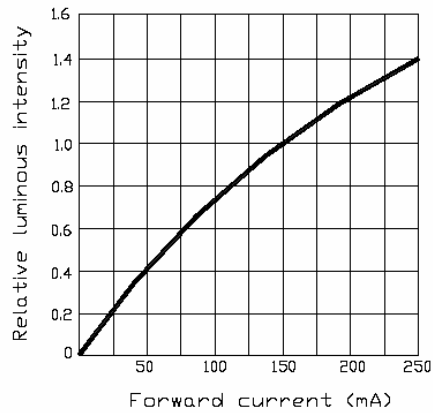

Fig.5 Relative luminous intensity vs. Ambient temperature

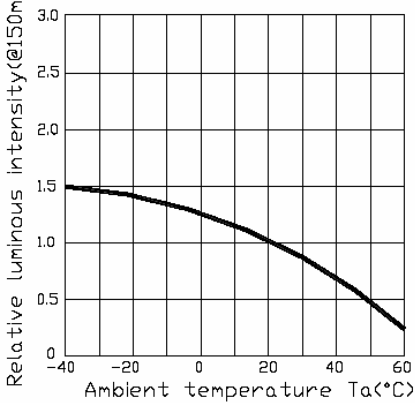
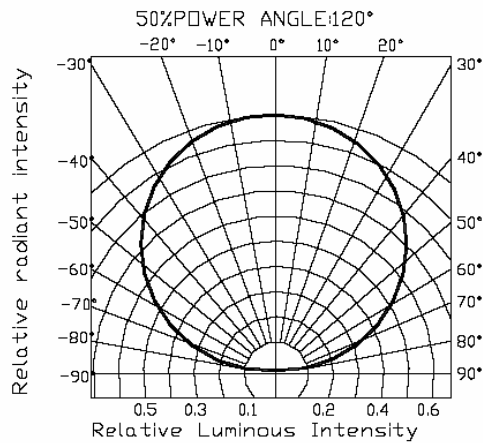

Fig.6 Radiation diagram



RELIABILITY TEST REPORT

CLASSIFICATION	TEST TIME	TEST CONDITION
ENDURANCE TEST	OPERATION LIFE	If:150mA Ta:25+5 TEST ITME=1000HRS(-24HRS,+72HRS)
	HIGH TEMPERTURE HIGH HUMIDITY STORAGE	R.H:90~95% Ta:65+5°C TEST ITME=240HRS(+2HRS)
	HIGH TEMPERTURE STORAGE	Ta:105±5°C TEST ITME=500HRS(-24HRS,+48HRS)
	LOW TEMPERTURE STORAGE	Ta:-55±5°C TEST ITME=500HRS(-24HRS,+48HRS)
ENVIRONMENTAL TEST	TEMPERTURE CYCLING	105°C~25°C~-55°C~25°C 60min 10min 60min 10min 20cycles
	THERMAL SHOCK	105°C~-55°C 10min 10min 10cycles
	SOLDER RESISTANCE	Ta:260±5°C TEST ITME=10±1sec
	SOLDERABILITY	Ta:230±5°C TEST ITME=5±1sec

JUDGMENT CRITERIA OF FAILURE FOR THE RELIABILITY

MEASURING ITME	SYMBOL	CONDITIONS	FAILUER
LUMINOUS INTENSITY	IV	IF=150mA	IV<0.5*INITIAL VALUE
FORWARD VOLTAGE	VF	IF=150mA	VF>1.2*INITIAL VALUE
REVERSE CURRENT	IR	Vr=5V	IR>2*SPEC

■ Recommended Reflow Soldering Profile

Surface mounting condition

In automatic mounting of the SMD LEDs on printed circuit boards, any bending, expanding and pulling forces or shock against the SMD LEDs should be kept min. to prevent them from electrical failures and mechanical damages of the devices.

Soldering reflow

- Soldering of the SMD LEDs should conform to the soldering condition in the individual specifications.
- SMD LEDs are designed for reflow soldering.
- In the reflow soldering, too high temperature and too large temperature gradient such as rapid heating/cooling may cause electrical & optical failures and damages of the devices.
- Wellypower can't guarantee the LEDs after they have been assembled using the solder dipping method.

1) Lead solder

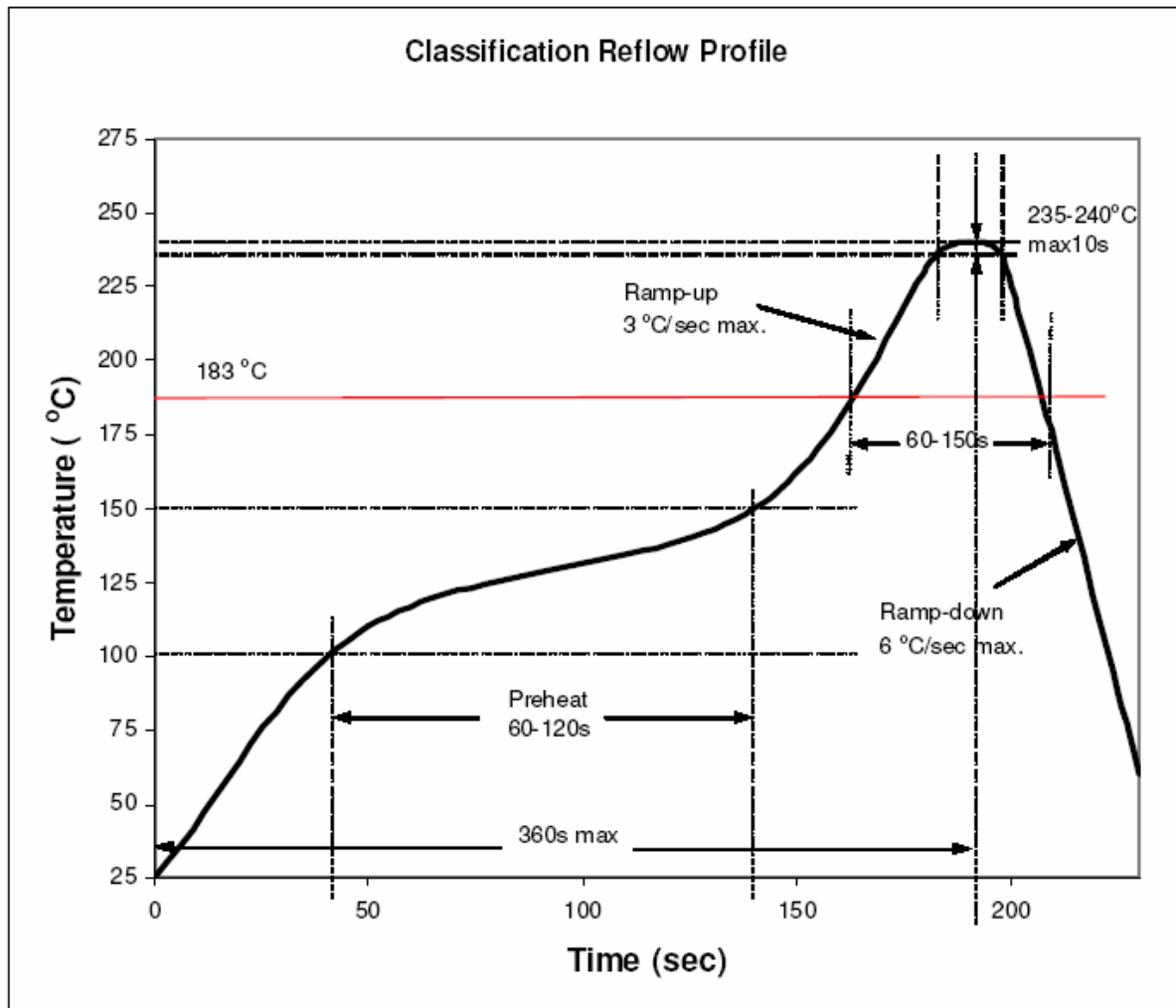

2) Lead-free solder

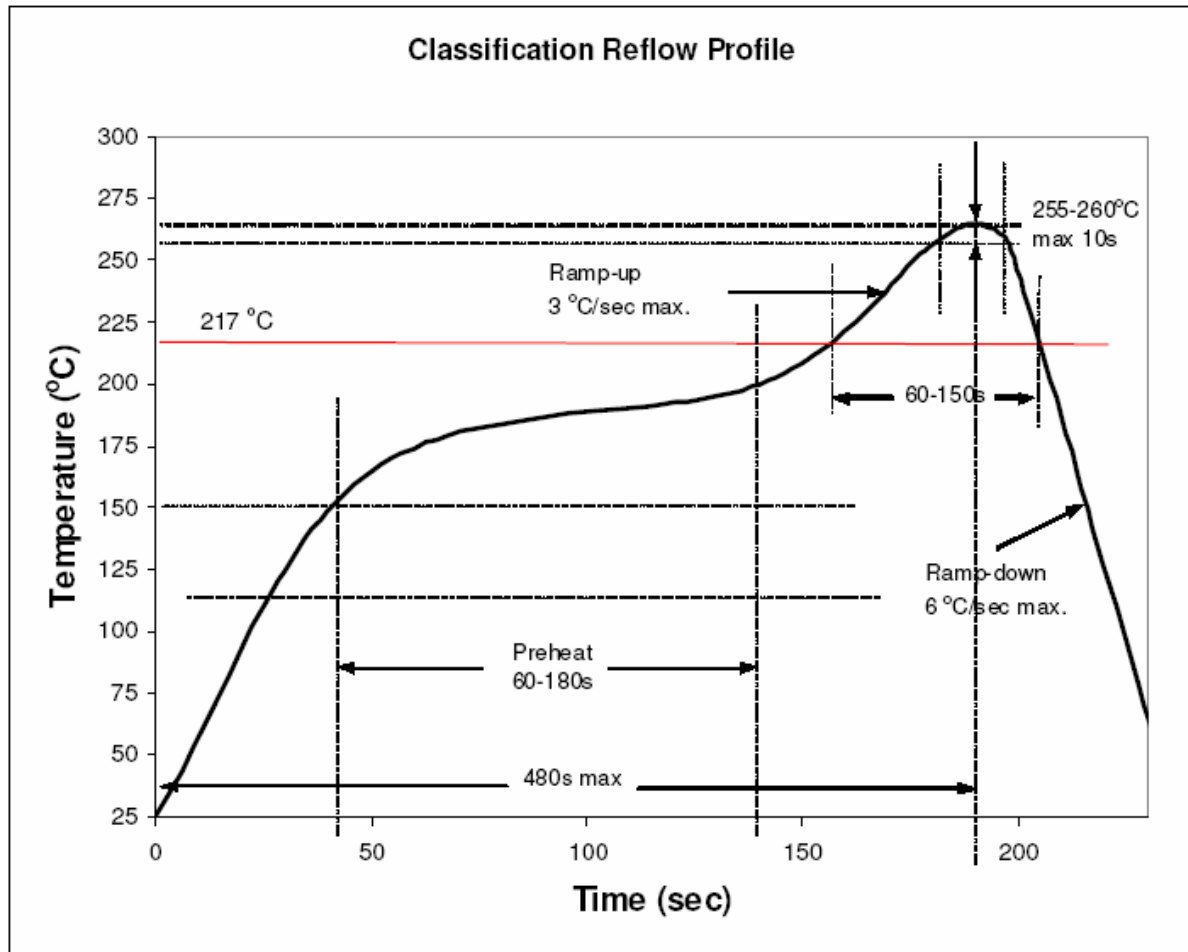

3) Manual soldering.

- Lead solder

Max. 300°C for max. 3sec, and only one time.

- Lead-free solder

Max. 350°C for max. 3sec, and only one time.

- There is possibility that the brightness of LEDs is decreased, which is influenced by heat or ambient atmosphere during reflow. It is recommended to use the nitrogen reflow method use the nitrogen reflow method.

- After LEDs have been soldered, repairs should not be done. As repair is unavoidable, a doublehead soldering iron should be used. It should be confirmed beforehand whether the characteristics of the LEDs will be damaged by repairing or not.

- Reflow soldering should not be done more than two times.

LED & Application Technologies



■ Package Model

Loaded Quantity 3000 pcs. Per Reel

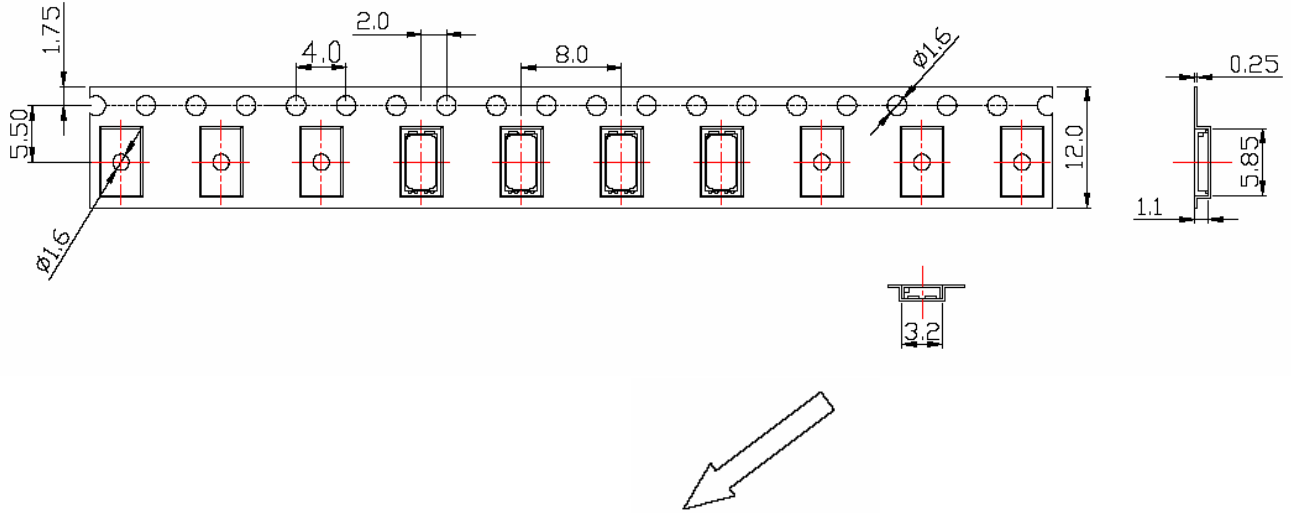

Reel Part

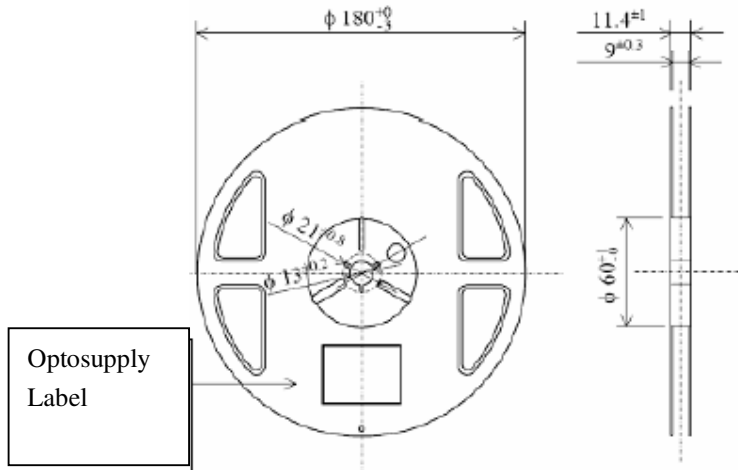

X-ON Electronics

Largest Supplier of Electrical and Electronic Components

Click to view similar products for [High Power LEDs - White category:](#)

Click to view products by [Optosupply manufacturer:](#)

Other Similar products are found below :

[G42180-08](#) [B42180-08](#) [STW8Q2PA-R5-HA](#) [SZ5-M1-W0-00-V3/W2-AA](#) [LTPL-P00DWS57](#) [LZP-D0WW00-0000](#) [CLM-9-30-90-36-AC32-F4-3](#) [SZ5-M1-WW-C8-V1/V3-FA](#) [BXRC-27E2000-D-73](#) [BXRC-27G2000-D-73](#) [BXRC-30E1000-D-73](#) [BXRC-30G2000-D-73](#) [BXRC-40E1000-D-73](#) [BXRE-30G2000-B-73](#) [BXRE-30G2000-C-73](#) [BXRE-50C2001-C-74](#) [CXM-22-27-80-54-AC30-F4-3](#) [XHP50B-00-0000-0D0UH245G](#) [XHP50B-00-0000-0D0UH240G](#) [XHP50B-00-0000-0D0UG227H](#) [XHP50B-00-0000-0D0HJ245G](#) [MP-5050-8100-27-80](#) [MP-5050-6100-65-80](#) [MP-5050-6100-50-80](#) [MP-5050-6100-40-80](#) [MP-5050-6100-30-80](#) [CXM-22-30-80-54-AC30-F4-3](#) [LTW-2835SZK57](#) [BXEM-50C0000-0-000](#) [WW-WNA30TS-U1\(M1\)](#) [KW CSLPM2.CC-8L8M-4L8N](#) [KW CSLPM2.CC-8L8M-4O9Q](#) [KW DPLS32.SB-6H6J-E5P7-EG-Z264](#) [L1V1-507003V500000](#) [CXM-22-35-80-36-AC10-F3-3](#) [KW3 CGLNM1.TG-Z6QF6-EBVFFCBB46-DFGA](#) [JB5630AWT-H-H65EA0000-NZ000001](#) [XHP50B-00-0000-0D0UG430H](#) [CXM-22-35-90-54-AC40-F5-3](#) [CXM-22-35-80-54-AC40-F5-3](#) [OSM51206E1N-0.8T](#) [OSW43020C1C](#) [MP161611032290](#) [MP-1616-2103-50-90](#) [KW CULPM1.TG-Z6RF7-ebvFfcbB46-65G5](#) [KW DMLS33.SG-Z6M7-EBVFFCBB46-8E8G-700-S](#) [XPGDWT-B1-0000-00EEA](#) [XHP70B-00-0000-0D0BP450E](#) [KW DMLN33.SG-7J7K-EBVFFCBB46-8E8G-200-S](#) [ASMT-MW05-NMNS1](#)