

■ **Features**

- High-power LED
- Long lifetime operation
- Typical viewing angle : 140deg
- RoHS compliant
- Possible to attach to heat sink directly without using print circuit board.

■ **Applications**

- Indoor & outdoor lighting
- Stage lighting
- Reading lamps
- Display cases, furniture illumination, marker
- Architectural illumination
- Spotlights

■ **Outline Dimension**

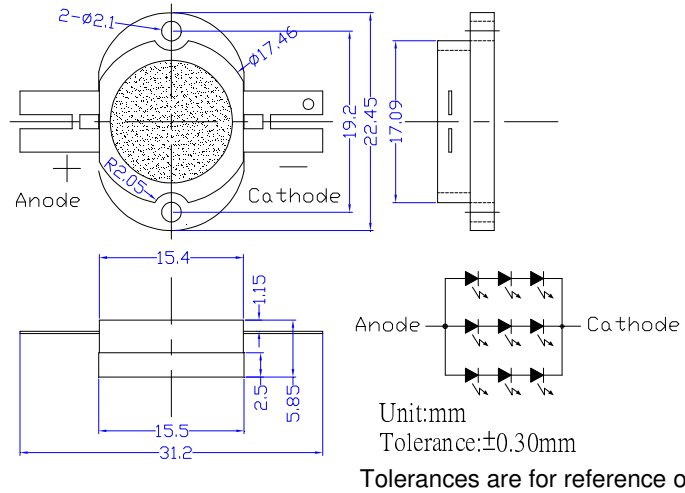

■ **Absolute Maximum Rating**

(Ta=25°C)

Item	Symbol	Value	Unit
DC Forward Current *1	I <sub>F</sub>	600	mA
Pulse Forward Current*2	I <sub>FP</sub>	1,000	mA
Reverse Voltage	V <sub>R</sub>	15	V
Power Dissipation*1	P <sub>D</sub>	6,840	mW
Operating Temperature	T <sub>opr</sub>	-30 ~ +85	°C
Storage Temperature	T <sub>stg</sub>	-40~ +100	°C
Lead Soldering Temperature	T <sub>sol</sub>	260°C /5sec	-

■ **Directivity**

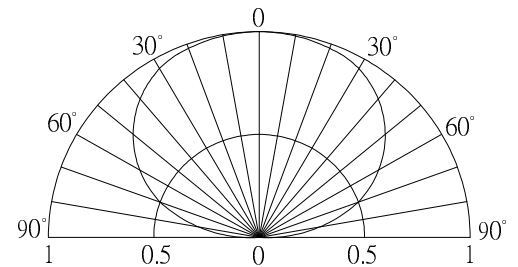

\*1, Power dissipation and forward current are the value when the module temperature is set lower than the rating by using an adequate heat sink.

\*2, Pulse width Max.10ms Duty ratio max 1/10

■ **Electrical -Optical Characteristics**

(Ta=25°C)

Item	Symbol	Condition	Min.	Typ.	Max.	Unit
DC Forward Voltage	V <sub>F</sub>	I <sub>F</sub> =500mA	8.7	10	11.4	V
DC Reverse Current	I <sub>R</sub>	V <sub>R</sub> =15V	-	-	30	μA
Luminous Flux	Φ <sub>v</sub>	I <sub>F</sub> =500mA	350	410	-	lm
Color Temperature	CCT	I <sub>F</sub> =500mA	-	6500	-	K
Chromaticity Coordinates*	x	I <sub>F</sub> =500mA	-	0.31	-	
	y	I <sub>F</sub> =500mA	-	0.34	-	
50% Power Angle	2θ <sub>1/2</sub>	I <sub>F</sub> =500mA	-	140	-	deg

Note: Don't drive at rated current more than 5s without heat sink for High Power series.

\* Tolerance of chromaticity coordinates is ±10% , \* Tolerance of Luminous Flux is ±20%

**■Heat design**

The following pictures show some measurements of mounted 5W Led on the heat sink for each board A and B (See Fig 1) with using thermograph to make an observation about heat distribution. Each boards is tested at various current conditions.

As a result, LED needs larger heat sink as much as possible to reduce its own case temperature.

**Fig. 1 Configuration pattern examples for board assembly**

Board	LED power	Material	Surface area (mm <sup>2</sup> )	Min.
A	5W	Al	10,300	
B	10W	Al	20,600	
C	25W	Al	51,500	
D	50W	Al	103,000	
E	100W	Al	206,000	
F	200W	Al	412,000	
G	300W	Al	618,000	

Above tested LED device is attached with adhesive sheet to the heatsink.

For reference's sake, Tj absolute maximum rating is defined at 115°C as a prerequisite on design process of 5W LED.

**<Fig.2> Board A (surface area=10,300mm<sup>2</sup>)**

**<Fig.3> Board B (surface area=20,600mm<sup>2</sup>)**

IF=200mA

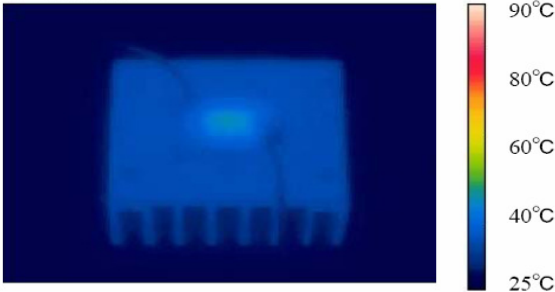

IF=200mA

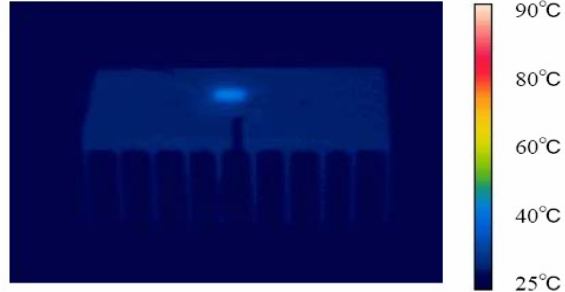

IF=400mA

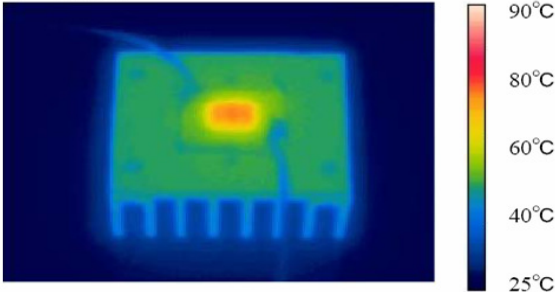

IF=400mA

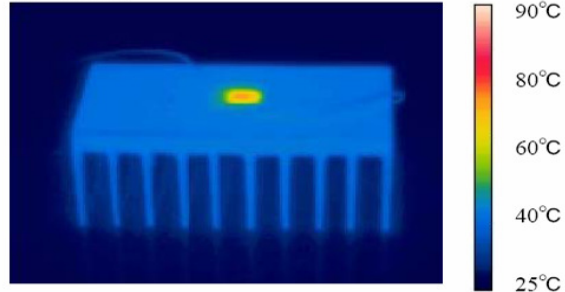

IF=600mA

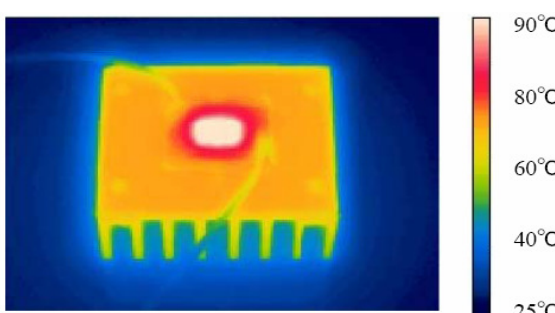

IF=600mA

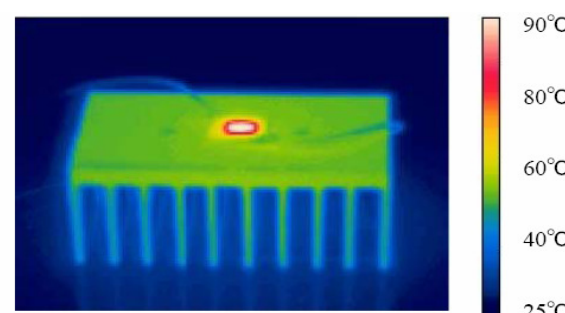

## X-ON Electronics

Largest Supplier of Electrical and Electronic Components

*Click to view similar products for [High Power LEDs - White category](#):*

*Click to view products by [Optosupply manufacturer](#):*

Other Similar products are found below :

[G42180-08](#) [B42180-08](#) [STW8Q2PA-R5-HA](#) [SZ5-M1-W0-00-V3/W2-AA](#) [LTPL-P00DWS57](#) [LZP-D0WW00-0000](#) [CLM-9-30-90-36-AC32-F4-3](#) [SZ5-M1-WW-C8-V1/V3-FA](#) [BXRC-27E2000-D-73](#) [BXRC-27G2000-D-73](#) [BXRC-30E1000-D-73](#) [BXRC-30G2000-D-73](#) [BXRC-40E1000-D-73](#) [BXRE-30G2000-B-73](#) [BXRE-30G2000-C-73](#) [BXRE-50C2001-C-74](#) [CXM-22-27-80-54-AC30-F4-3](#) [XHP50B-00-0000-0D0UH245G](#) [XHP50B-00-0000-0D0UH240G](#) [XHP50B-00-0000-0D0UG227H](#) [XHP50B-00-0000-0D0HJ245G](#) [MP-5050-8100-27-80](#) [MP-5050-6100-65-80](#) [MP-5050-6100-50-80](#) [MP-5050-6100-40-80](#) [MP-5050-6100-30-80](#) [CXM-22-30-80-54-AC30-F4-3](#) [LTW-2835SZK57](#) [BXEM-50C0000-0-000](#) [WW-WNA30TS-U1\(M1\)](#) [KW CSLPM2.CC-8L8M-4L8N](#) [KW CSLPM2.CC-8L8M-4O9Q](#) [KW DPLS32.SB-6H6J-E5P7-EG-Z264](#) [L1V1-507003V500000](#) [CXM-22-35-80-36-AC10-F3-3](#) [KW3 CGLNM1.TG-Z6QF6-EBVFFCBB46-DFGA](#) [JB5630AWT-H-H65EA0000-NZ000001](#) [XHP50B-00-0000-0D0UG430H](#) [CXM-22-35-90-54-AC40-F5-3](#) [CXM-22-35-80-54-AC40-F5-3](#) [OSM51206E1N-0.8T](#) [OSW43020C1C](#) [MP161611032290](#) [MP-1616-2103-50-90](#) [KW CULPM1.TG-Z6RF7-ebvFfcbB46-65G5](#) [KW DMLS33.SG-Z6M7-EBVFFCBB46-8E8G-700-S](#) [XPGDWT-B1-0000-00EEA](#) [XHP70B-00-0000-0D0BP450E](#) [KW DMLN33.SG-7J7K-EBVFFCBB46-8E8G-200-S](#) [ASMT-MW05-NMNS1](#)