

ProLight PACB-9FxL-xC4P  
9W COB Light-Engine LEDs  
Technical Datasheet  
Version: 1.4

# ProLight Opto ® ProEngine Series

## Features

- High flux density of lighting source
- Good color uniformity
- RoHS compliant
- Energy Star binning structure, neutral white and warm white with 3 steps guarantee.
- More energy efficient than incandescent and most halogen lamps
- No UV
- Long lifetime
- 5 year warranty

## Main Applications

- Par lighting
- LED Bulb
- Ceiling lighting
- Spot lighting
- Down lighting

## Introduction

- The input power is 9 Watt, the multi-chip ultra high power ProEngine Series delivers never before seen luminous flux output from a single emitter. The superficial illuminating nature of ProEngine makes them the preference in Par lighting, typical applications include commercial down lighting, LED bulb, accent lighting, ceiling lighting and spot lighting.

## Emitter Mechanical Dimensions

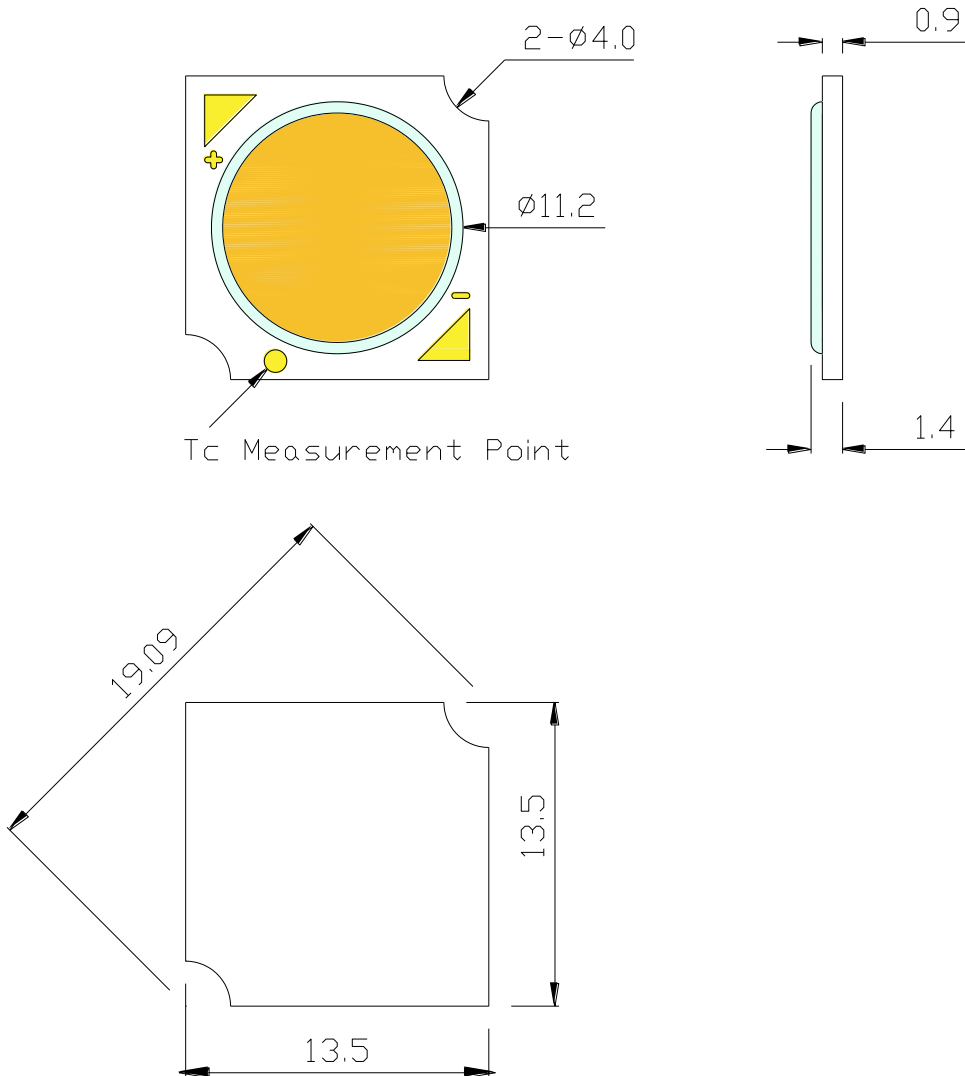

### Notes:

1. Slots in aluminum-core PCB for M3 mounting screw.
2. Solder pads are labeled "+" and "-" to denote positive and negative, respectively.
3. Drawing not to scale.
4. All dimensions are in millimeters.
5. Unless otherwise indicated, tolerances are  $\pm 0.30\text{mm}$ .
6. **Please do not use a force of over 0.3kgf impact or pressure on the lens of the LED, otherwise it will cause a catastrophic failure.**

\*The appearance and specifications of the product may be modified for improvement without notice.

## Flux Characteristics, $T_c = 25^\circ\text{C}$

Radiation Pattern	Color	Part Number COB	DC Forward Current (mA)	Luminous Flux $\Phi_v$ (lm)		CRI Minimum
				Minimum	Typical	
Lambertian	White	PACB-9FWL-BC4P	240*	1100	1230	80
			480	2000	2220	
	Neutral White	PACB-9FNL-BC4P	240*	1090	1210	80
			480	1970	2190	
	Warm White	PACB-9FVL-BC4P	240*	1000	1160	80
			480	1800	2100	
		PACB-9FVL-DC4P	240*	700	820	93
			480	1270	1480	

- The mark "\*" indicated product is tested and binned at the specified drive current.
- ProLight maintains a tolerance of  $\pm 7\%$  on flux and power measurements.
- ProLight maintains a tolerance of  $\pm 2$  on CRI measurements.
- Please do not drive at rated current more than 1 second without proper heat sink.

## Electrical Characteristics at 240mA, $T_c = 25^\circ\text{C}$

Color	Forward Voltage $V_F$ (V)			Thermal Resistance Junction to Board ( $^\circ\text{C}/\text{W}$ )
	Min.	Typ.	Max.	
White	33.0	35.5	38.0	2.1
Neutral White	33.0	35.5	38.0	2.1
Warm White	33.0	35.5	38.0	2.1

- ProLight maintains a tolerance of  $\pm 1\text{V}$  for Voltage measurements.

## Optical Characteristics at 240mA, $T_c = 25^\circ\text{C}$

Radiation Pattern	Color	Color Temperature CCT			Total included Angle (degrees)	Viewing Angle (degrees)
		Min.	Typ.	Max.	$\theta_{0.90v}$	$2\theta_{1/2}$
Lambertian	White	4740 K	5000 K	5310 K	160	120
	Neutral White	3840 K	4000 K	4130 K	160	120
		2650 K	2700 K	2800 K	160	120
	Warm White	2860 K	2940 K	3020 K	160	120
		2960 K	3000 K	3130 K	160	120

- ProLight maintains a tolerance of  $\pm 5\%$  for CCT measurements.

## Electro-Optical Characteristics, $T_j = 25^\circ\text{C}$

$I_F$ (mA)	$V_F$ (V)	Power (W)	PACB-9FWL-BC4P Flux (lm)	PACB-9FNL-BC4P Flux (lm)
160	34.54	5.53	853	839
200	35.03	7.01	1044	1027
240	35.50	8.52	1230	1210
280	35.94	10.06	1408	1385
320	36.37	11.64	1583	1557
360	36.77	13.24	1751	1723
400	37.17	14.87	1913	1882
440	37.54	16.52	2073	2039
480	37.91	18.20	2225	2189

$I_F$ (mA)	$V_F$ (V)	Power (W)	PACB-9FVL-BC4P Flux (lm)	PACB-9FVL-DC4P Flux (lm)
160	34.54	5.53	804	569
200	35.03	7.01	985	696
240	35.50	8.52	1160	820
280	35.94	10.06	1328	939
320	36.37	11.64	1493	1055
360	36.77	13.24	1651	1167
400	37.17	14.87	1805	1276
440	37.54	16.52	1955	1382
480	37.91	18.20	2099	1484

● All values are reference only.

## Absolute Maximum Ratings

Parameter	White/Neutral White/Warm White
Max DC Forward Current (mA)	480
Peak Pulsed Forward Current (mA)	720 (less than 1/10 duty cycle@1KHz)
ESD Sensitivity (HBM per MIL-STD-883E Method 3015.7)	±2000V
LED Junction Temperature	120°C
Operating Board Temperature at Maximum DC Forward Current	-40°C - 90°C
Storage Temperature	-40°C - 120°C
Reverse Voltage	Not designed to be driven in reverse bias

---

## Color Bin

### White Binning Structure Graphical Representation

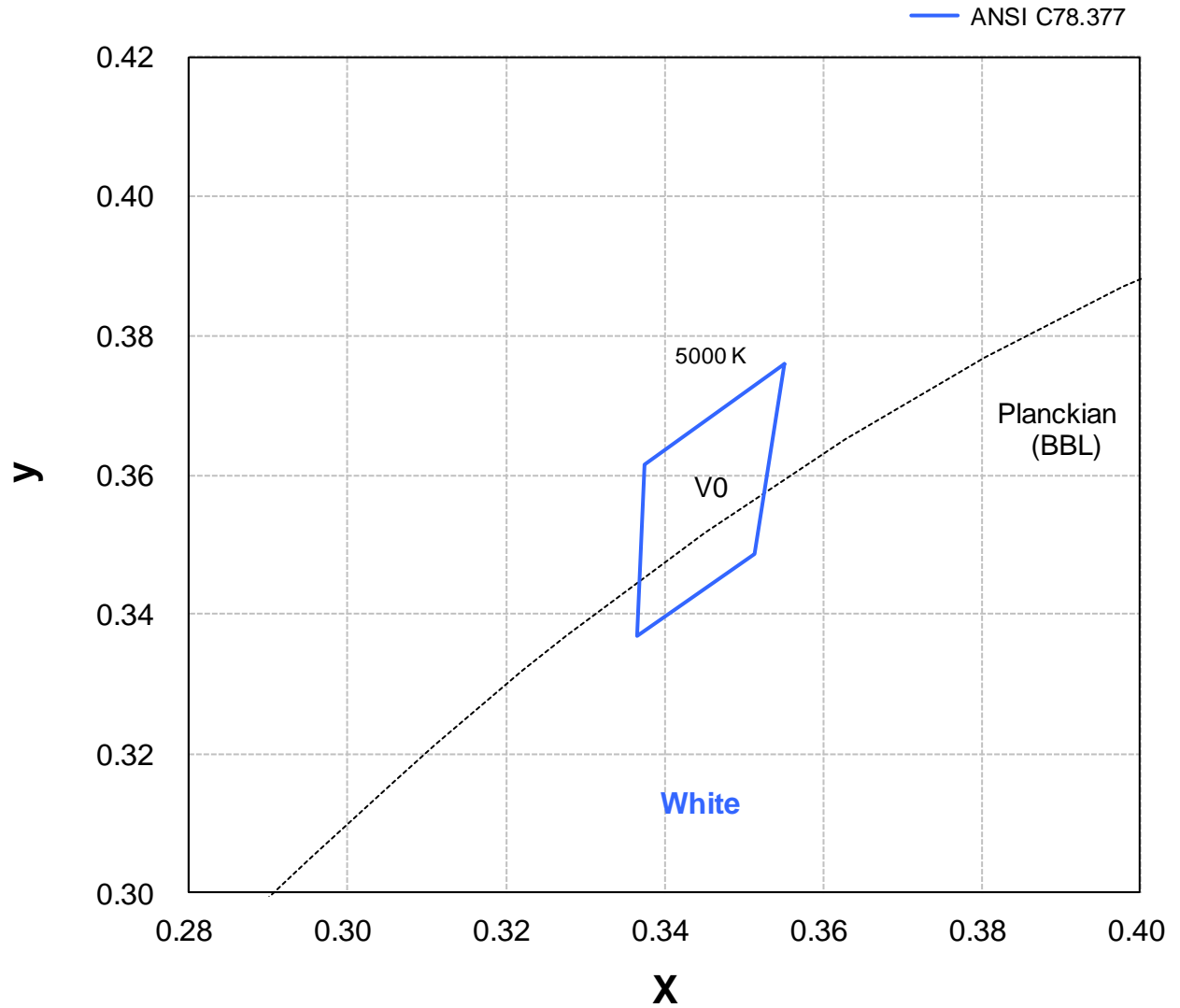

#### White Bin Structure

Bin Code	x	y	Typ. CCT (K)
V0	0.3551	0.3760	5000
	0.3376	0.3616	
	0.3366	0.3369	
	0.3515	0.3487	

- Tolerance on each color bin (x , y) is  $\pm 0.005$

## Color Bin

### Neutral White Binning Structure Graphical Representation

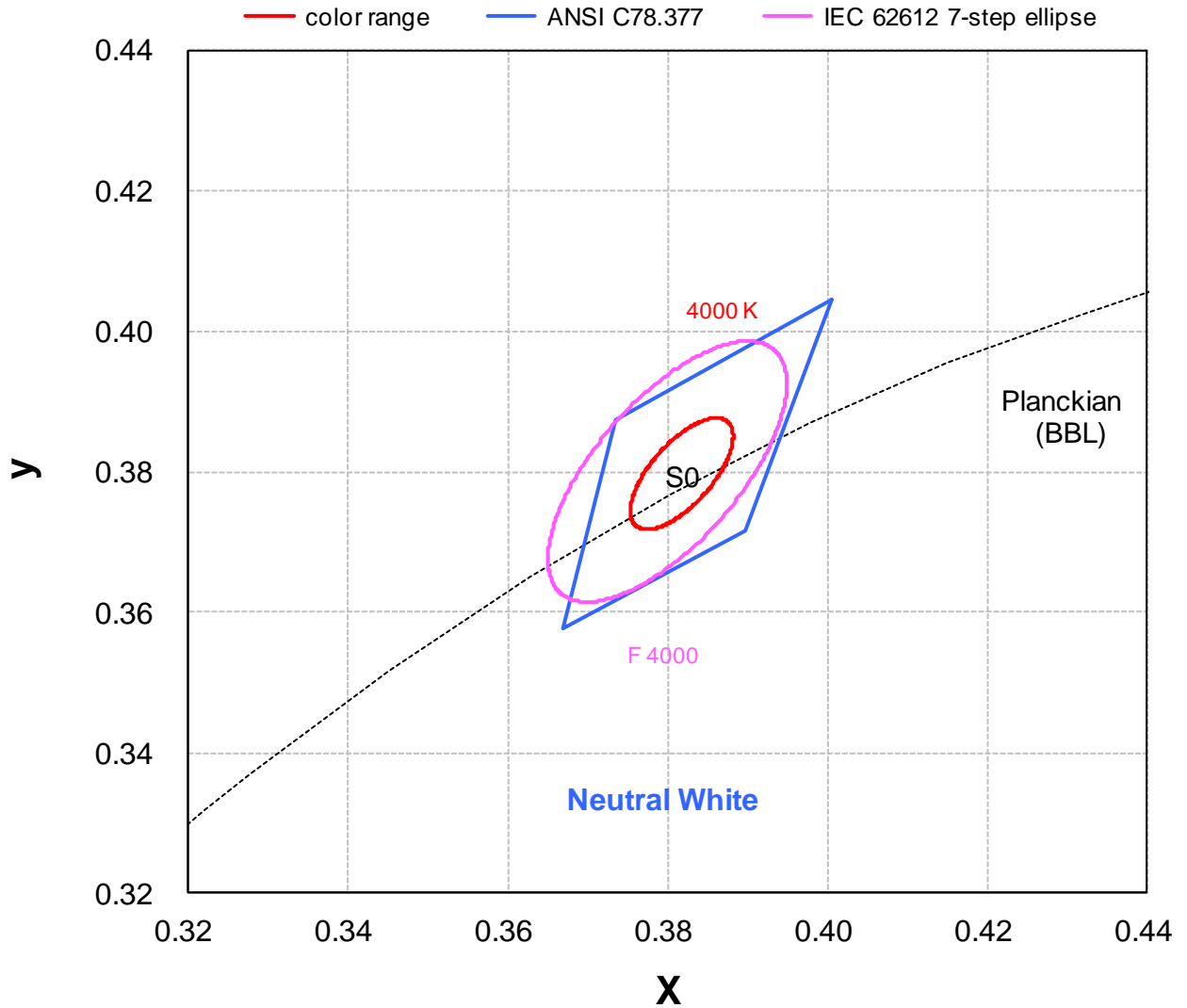

#### Neutral White Bin Structure

Bin Code	Center	Oval parameter	Typ. CCT (K)
S0	x	a	4000
	y	b	
		$e^\circ$	

- Color range stay within MacAdam "3-step" ellipse from the chromaticity center.
- The chromaticity center refers to ANSI C78.377.
- Tolerance on each color bin (x , y) is  $\pm 0.005$

## Color Bin

### Warm White Binning Structure Graphical Representation

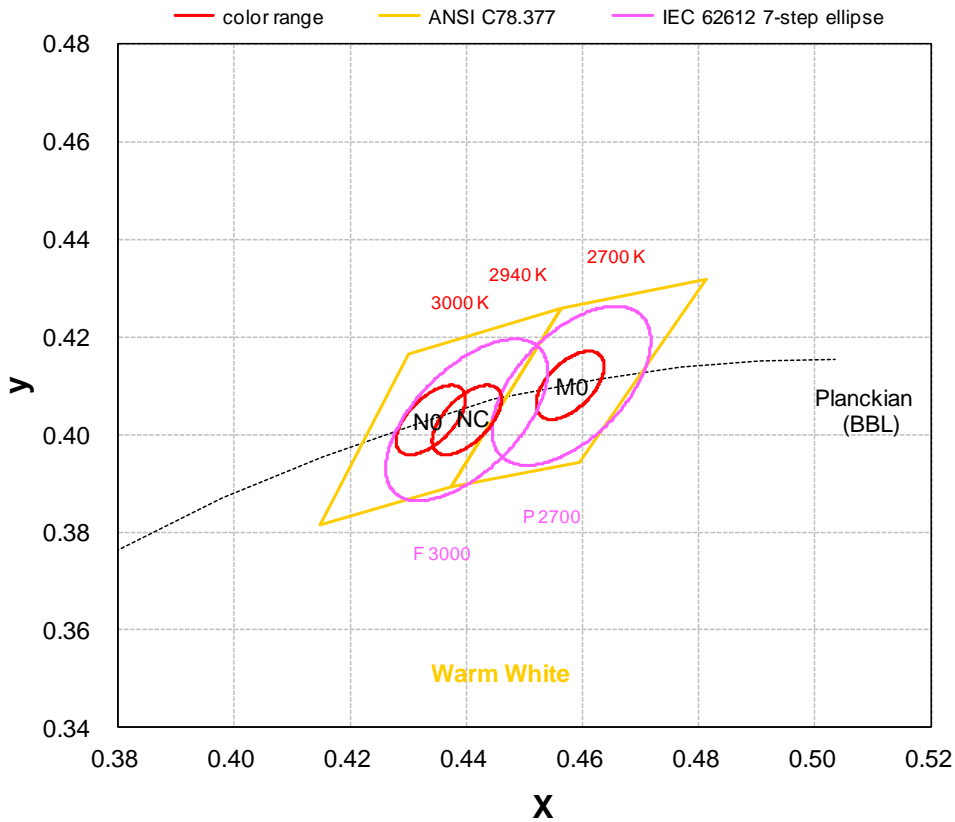

### Warm White Bin Structure

Bin Code	Center	Oval parameter	Typ. CCT (K)	Bin Code	Center	Oval parameter	Typ. CCT (K)
M0	x 0.4578 y 0.4101	a 0.00810 b 0.00420 e° 53.70	2700	N0	x 0.4338 y 0.4030	a 0.00834 b 0.00408 e° 53.22	3000

- Color range stay within MacAdam “3-step” ellipse from the chromaticity center.
- The chromaticity center refers to ANSI C78.377.
- Tolerance on each color bin (x , y) is  $\pm 0.005$

Bin Code	Center	Oval parameter	Typ. CCT (K)
NC	x 0.4400 y 0.4030	a 0.00834 b 0.00408 e° 53.02	2940

- Color range stay within MacAdam “3-step” ellipse from the chromaticity center.
- The chromaticity center refers to IEC 62612.
- Tolerance on each color bin (x , y) is  $\pm 0.005$



## Color Spectrum, $T_c = 25^\circ\text{C}$

### 1. White

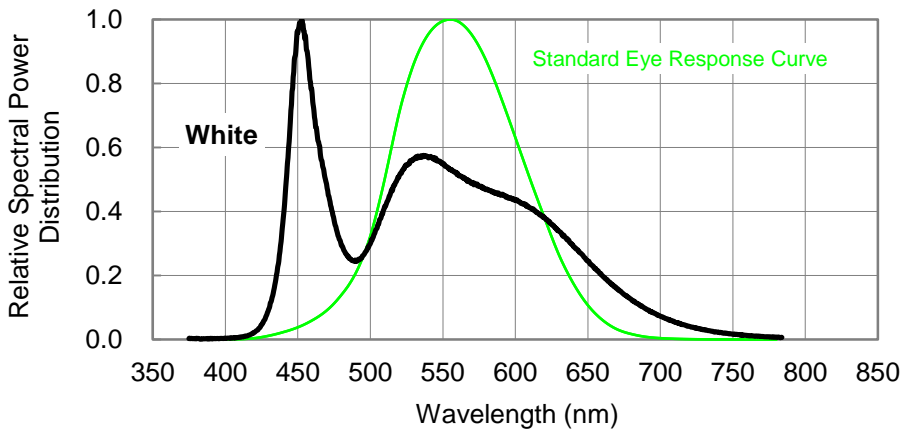

### 2. Neutral White

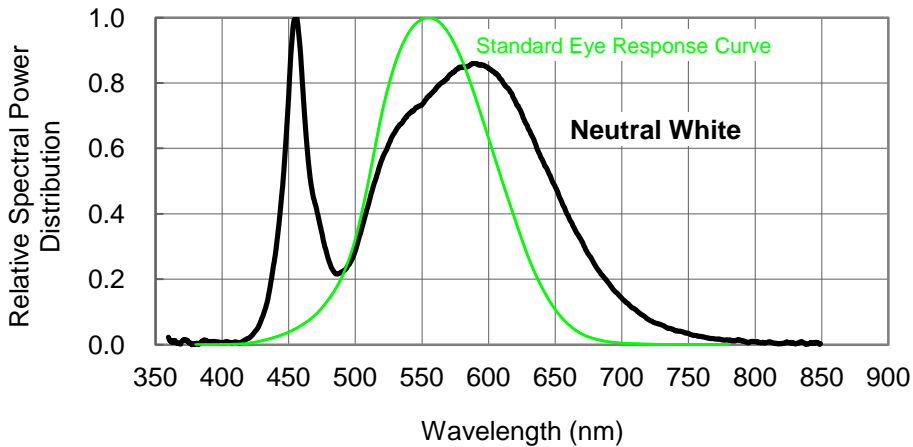

### 3. Warm White

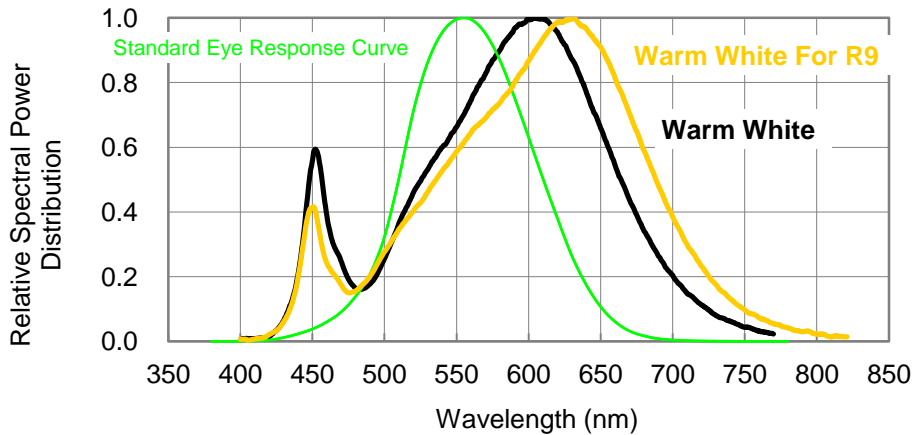

## Case Temperature Relative Characteristics

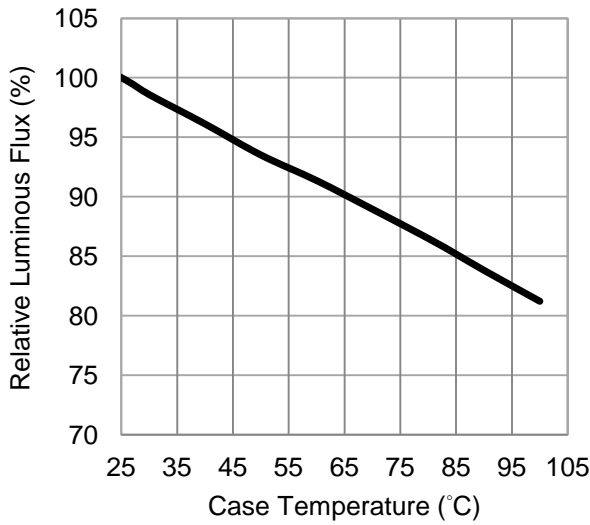

Fig 1. Case Temperature vs. Relative Luminous Flux at 240mA.

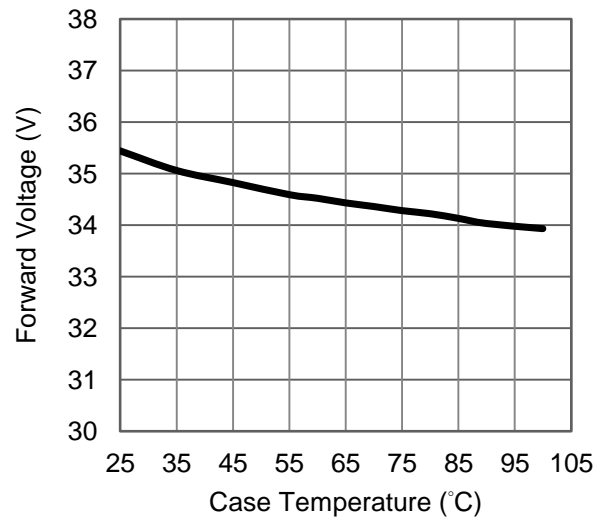

Fig 2. Case Temperature vs. Forward Voltage at 240mA.

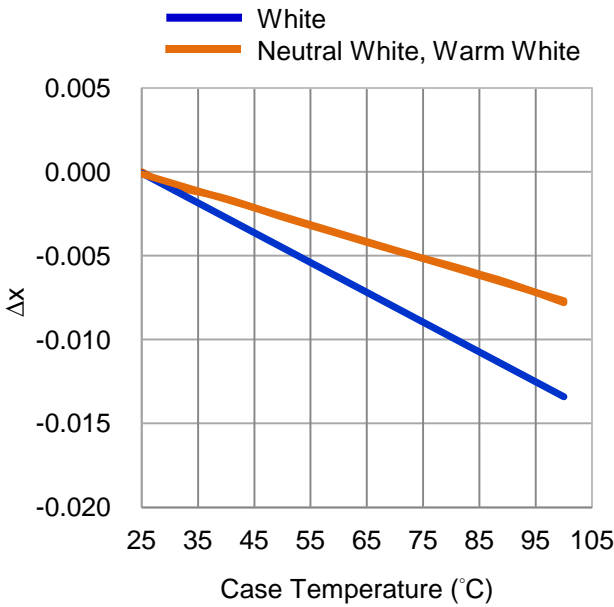

Fig 3. Case Temperature vs. Chromaticity Coordinate  $\Delta x$  at 240mA.

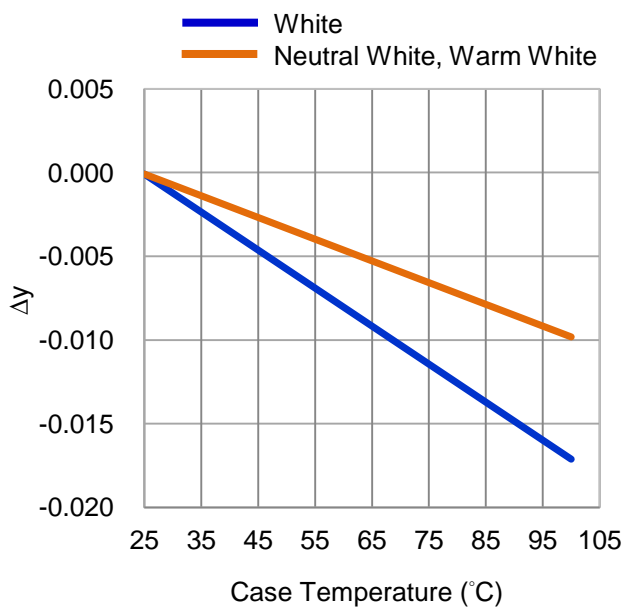

Fig 4. Case Temperature vs. Chromaticity Coordinate  $\Delta y$  at 240mA.

## Forward Current Relative Characteristics

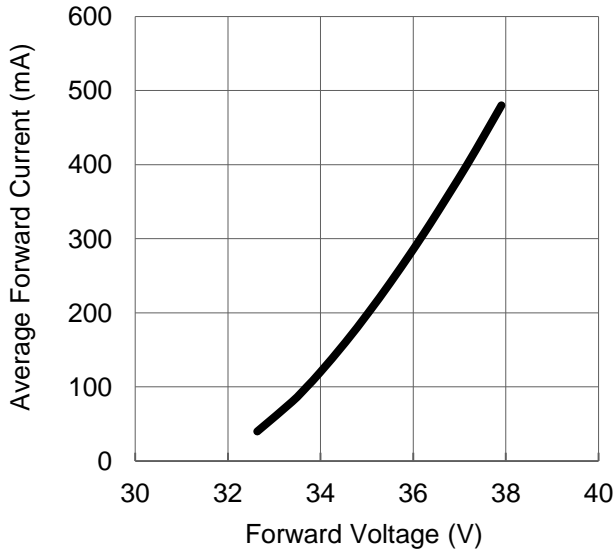

Fig 5. Forward Current vs. Forward Voltage at  $T_C=25^\circ\text{C}$ .

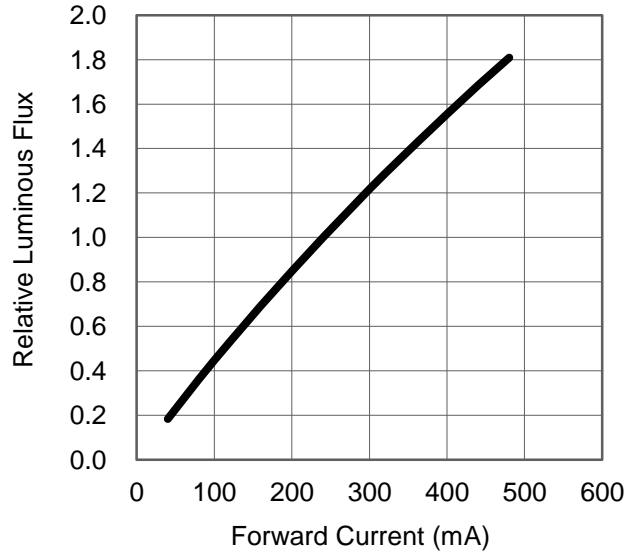

Fig 6. Forward Current vs. Relative Luminous Flux at  $T_C=25^\circ\text{C}$ .

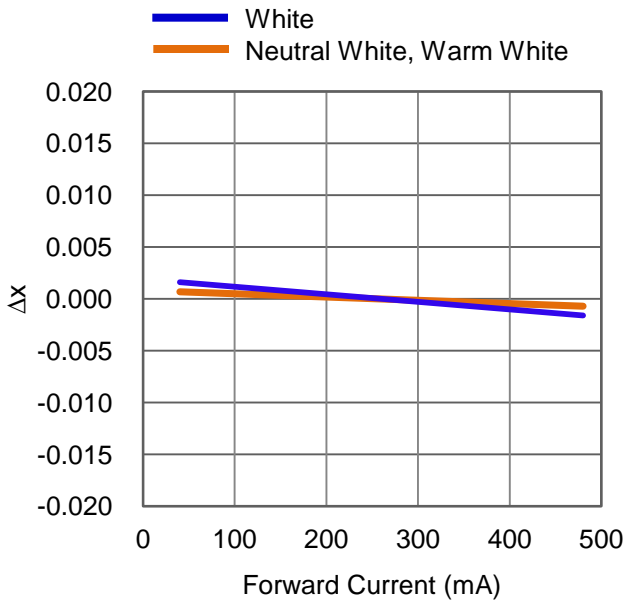

Fig 7. Forward Current vs. Chromaticity Coordinate  $\Delta x$  at  $T_C=25^\circ\text{C}$ .

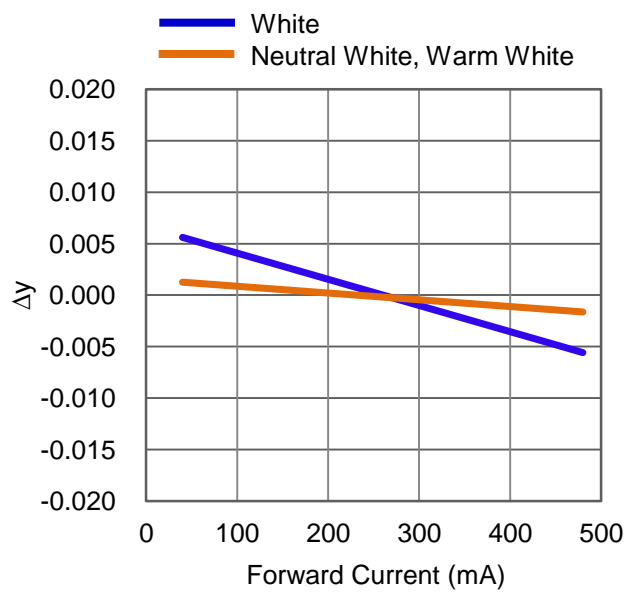

Fig 8. Forward Current vs. Chromaticity Coordinate  $\Delta y$  at  $T_C=25^\circ\text{C}$ .

## Case Temperature vs. Junction Temperature Characteristics

T <sub>c</sub> (°C)	T <sub>j</sub> (°C)	
	240 (mA)	480 (mA)
0	18	38
5	23	43
10	28	48
15	33	53
20	38	58
25	43	63
30	48	68
35	53	73
40	58	78
45	63	83
50	68	88
55	73	93
60	78	98
65	83	103
70	88	108
75	93	113
80	98	118
85	103	123
90	108	128

Fig 9. Case Temperature vs. Junction Temperature at 240 、 480mA.

# Color Coordinate vs. Forward Current, $T_c = 25^\circ\text{C}$

White Binning Graphical Representation

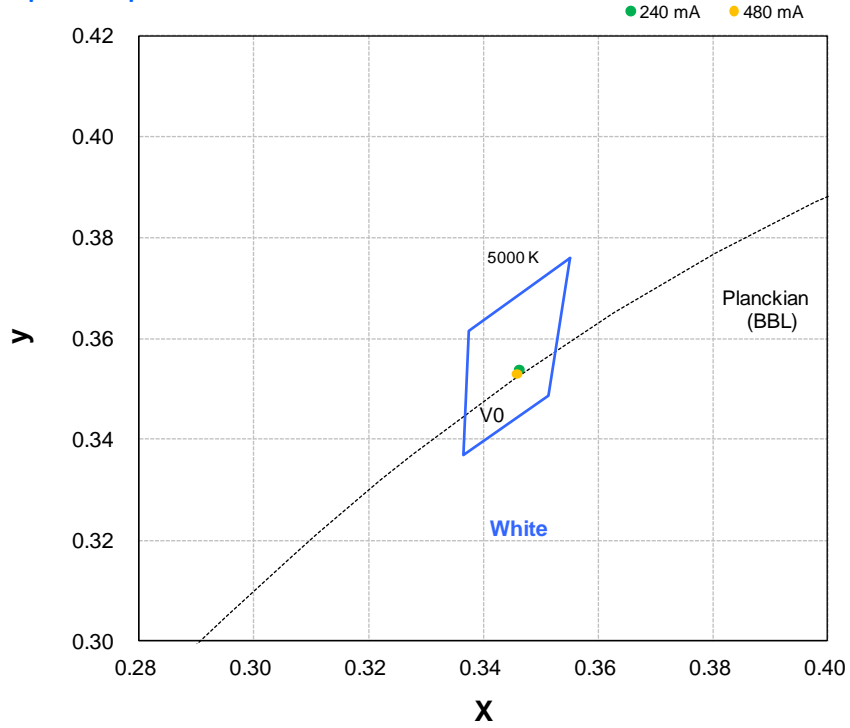

Neutral White Binning Graphical Representation

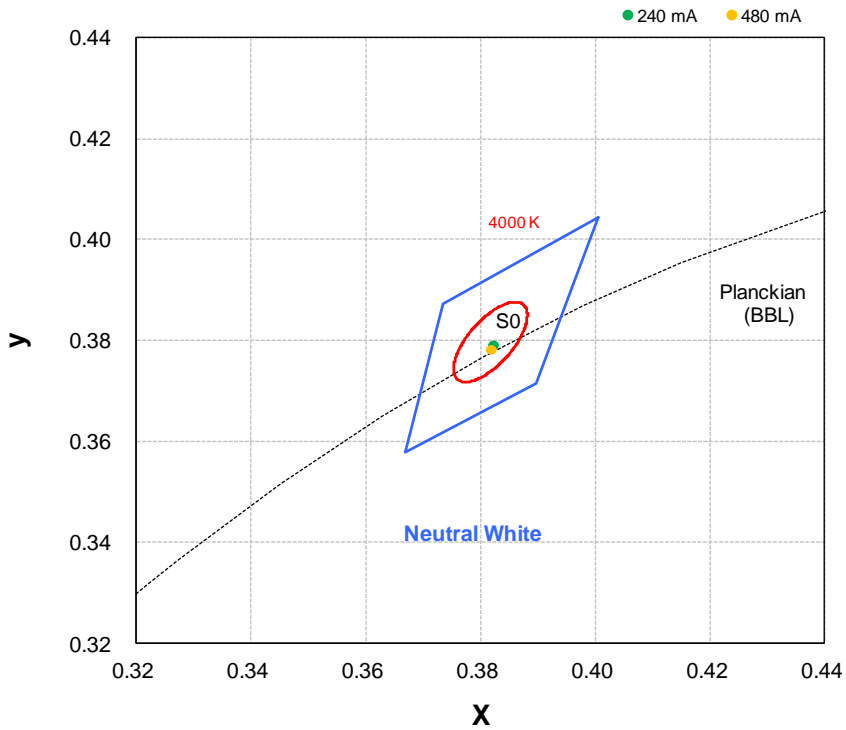

## Color Coordinate vs. Forward Current, $T_c = 25^\circ\text{C}$

### Warm White Binning Graphical Representation

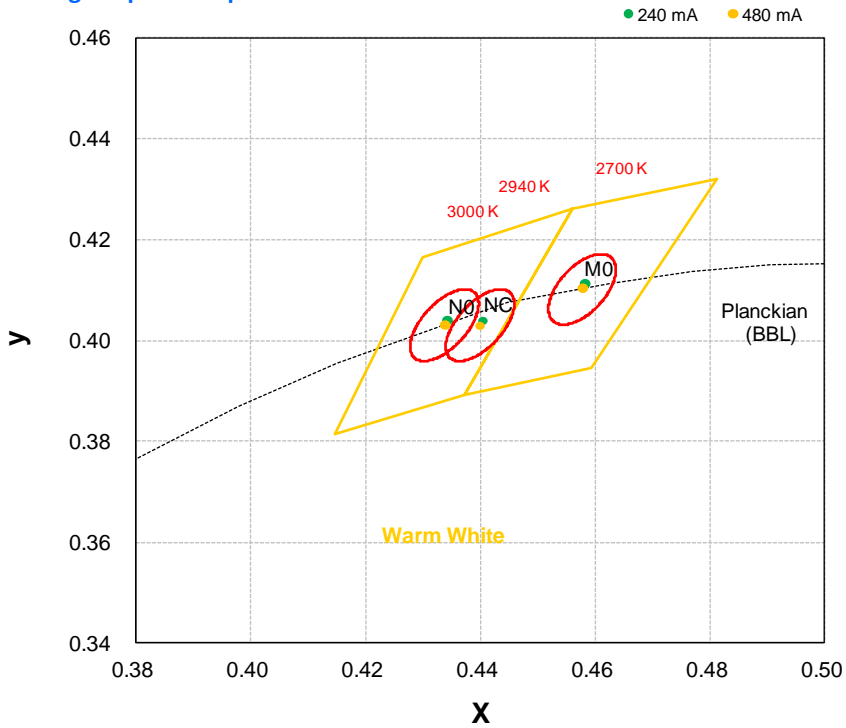

# Typical Representative Spatial Radiation Pattern

## Lambertian Radiation Pattern

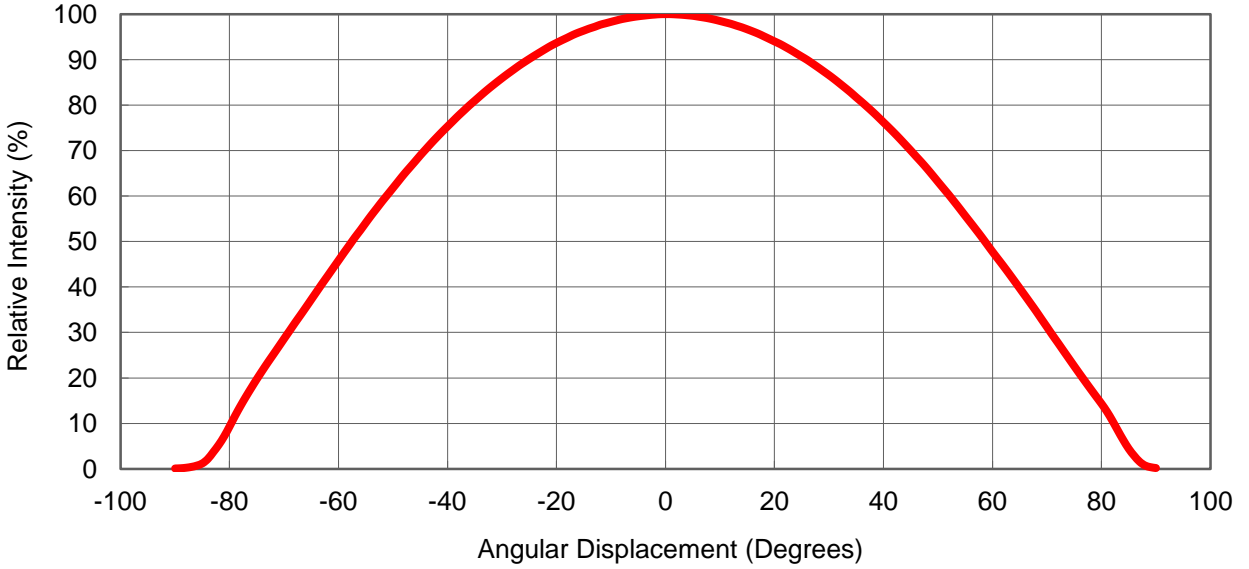

## Polar Radiation Pattern

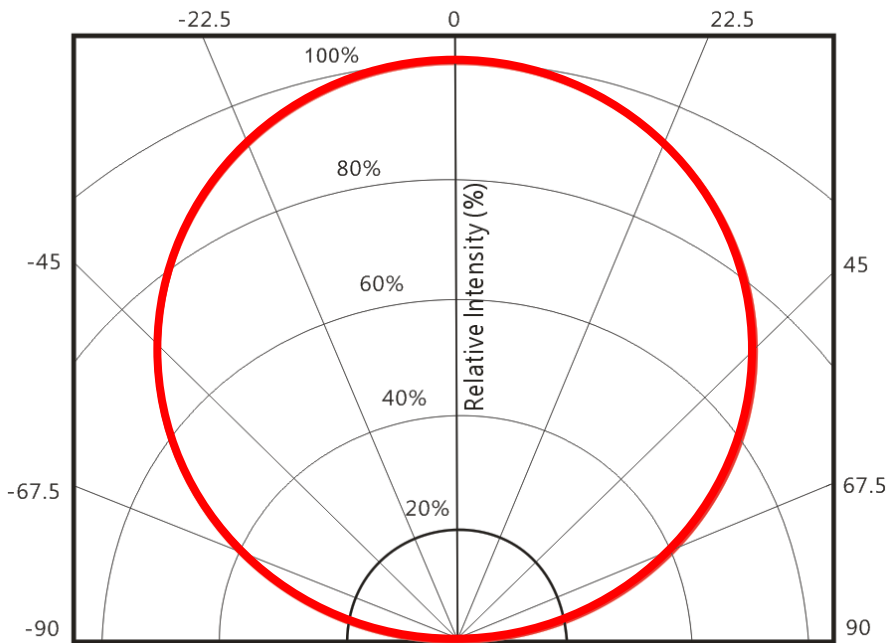

## Packing Specifications

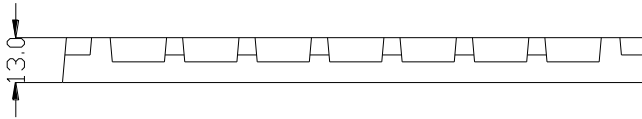
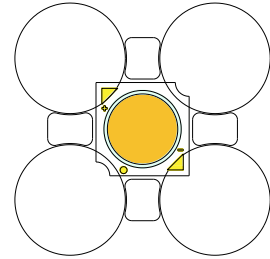
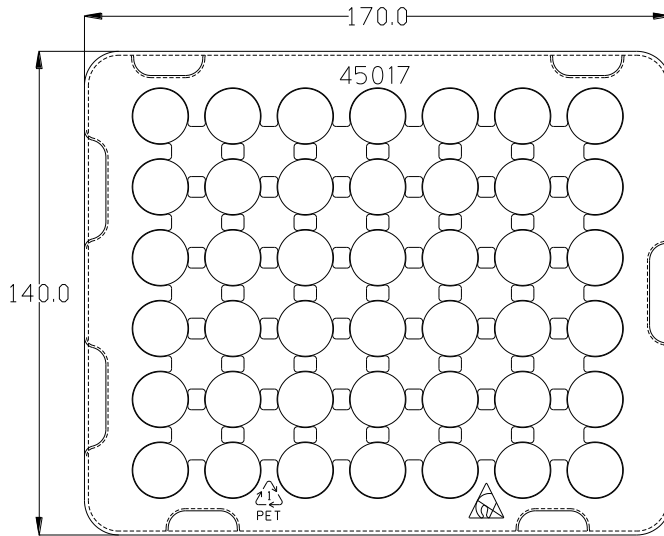

Product 30 pcs/tray

Notes:

1. Drawing not to scale.
2. All dimensions are in millimeters.
3. Unless otherwise indicated, tolerances are  $\pm 0.20\text{mm}$ .



## Assembly note

Regarding the high power density of LED Array, it is strongly recommend to use thermal grease and screws.

In order to reduce thermal resistance at assembly, it is necessary to use TIM (thermal interface Material) uniformly and tighten screws on heatsink, otherwise the bad thermal resistance may cause the packages **burned out**.

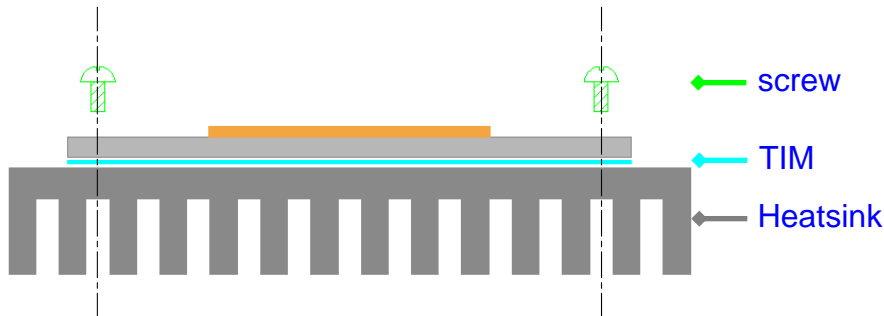

Fig 10. Reference assembly as fixing with screws

## Limited Warranty : COB Light Engine Series

This limited warranty is provided by ProLight Opto described below (“Seller”) to you as the original purchaser of the LED lighting product that is identified on Seller’s invoice reflecting its original purchase (the “Product”). We warrant the identification as such on the invoice, will be free of defects in material and workmanship for a period of five (5) YEARS from the date of original purchase. This limited warranty excludes field labor and service charges related to the repair or replacement of the Product. Seller’s aggregate liability with respect to a defective product shall in any event be limited to the monies paid to seller for that defective product. The determination of whether the Product is defective shall be made by Seller in its sole discretion with consideration given to the overall performance of the Product. This limited warranty cannot be transferred to subsequent purchasers of the Product, provided that such Product is resold in new condition and in its original packaging. This limited warranty is void if the product is not used for the purpose for which it is designed.

## Recommended Soldering Condition

- Please use lead free and “no clean ” solders.
- Soldering shall be implemented using a soldering tip at a temperature lower than 350 °C , and shall be finished within 3.5 seconds for each pad.
- During the soldering process, put the LEDs on materials whose conductivity is poor enough not to radiate heat of soldering.
- Properly solder tin wires before soldering them to LEDs.
- Avoid touching the silicone lens with the soldering iron.
- Please prevent flux from touching to the silicone lens.
- Please solder evenly on each pad.
- Contacts number of a soldering tip should be within twice for each pad.
- Next process of soldering should be carried out after the LEDs have return to ambient temperature.

\*ProLight cannot guarantee if usage exceeds these recommended conditions.

Please use it after sufficient verification is carried out on your own risk if absolutely necessary.

## Precaution for Use

- The modules light output are intense enough to cause injury to human eyes if viewed directly. Precautions must be taken to avoid looking directly at the modules with unprotected eyes.
- The modules are sensitive to electrostatic discharge. Appropriate ESD protection measures must be taken when working with the modules. Non-compliance with ESD protection measures may lead to damage or destruction of the product.
- Chemical solvents or cleaning agents must not be used to clean the modules. Mechanical stress on the Emitters must be avoided. It is best to use a soft brush, damp cloth or low-pressure compressed air.
- The products should be stored away from direct light in dry location.
- The appearance, specifications and flux bin of the product may be modified for improvement without notice. Please refer to the below website for the latest datasheets.  
<http://www.prolightopto.com/>

## Handling of Silicone Lens LEDs

Notes for handling of silicone lens LEDs

- Please do not use a force of over 0.3kgf impact or pressure on the silicone lens, otherwise it will cause a catastrophic failure.
- Avoid touching the silicone lens and the optical area of the COB Array especially by sharp tools such as Tweezers
- Avoid touching the silicone lens especially by sharp tools such as Tweezers.
- Avoid leaving fingerprints on the silicone lens.
- Please store the LEDs away from dusty areas or seal the product against dust.
- Please do not mold over the silicone lens with another resin. (epoxy, urethane, etc)

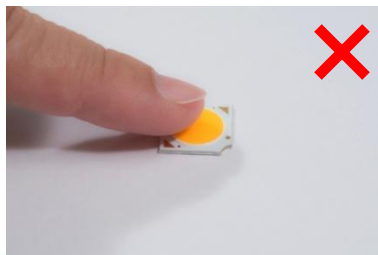

## X-ON Electronics

Largest Supplier of Electrical and Electronic Components

*Click to view similar products for [High Power LEDs - White category:](#)*

*Click to view products by [Prolight manufacturer:](#)*

Other Similar products are found below :

[G42180-08](#) [B42180-08](#) [STW8Q2PA-R5-HA](#) [SZ5-M1-W0-00-V3/W2-AA](#) [LTPL-P00DWS57](#) [LZP-D0WW00-0000](#) [CLM-9-30-90-36-AC32-F4-3](#) [SZ5-M1-WW-C8-V1/V3-FA](#) [BXRC-27E2000-D-73](#) [BXRC-27G2000-D-73](#) [BXRC-30E1000-D-73](#) [BXRC-30G2000-D-73](#) [BXRC-40E1000-D-73](#) [BXRE-30G2000-B-73](#) [BXRE-30G2000-C-73](#) [BXRE-50C2001-C-74](#) [CXM-22-27-80-54-AC30-F4-3](#) [XHP50B-00-0000-0D0UH245G](#) [XHP50B-00-0000-0D0UH240G](#) [XHP50B-00-0000-0D0UG227H](#) [XHP50B-00-0000-0D0HJ245G](#) [MP-5050-8100-27-80](#) [MP-5050-6100-65-80](#) [MP-5050-6100-50-80](#) [MP-5050-6100-40-80](#) [MP-5050-6100-30-80](#) [CXM-22-30-80-54-AC30-F4-3](#) [LTW-2835SZK57](#) [BXEM-50C0000-0-000](#) [WW-WNA30TS-U1\(M1\)](#) [KW CSLPM2.CC-8L8M-4L8N](#) [KW CSLPM2.CC-8L8M-4O9Q](#) [KW DPLS32.SB-6H6J-E5P7-EG-Z264](#) [L1V1-507003V500000](#) [CXM-22-35-80-36-AC10-F3-3](#) [KW3 CGLNM1.TG-Z6QF6-EBVFFCBB46-DFGA](#) [JB5630AWT-H-H65EA0000-NZ000001](#) [XHP50B-00-0000-0D0UG430H](#) [CXM-22-35-90-54-AC40-F5-3](#) [CXM-22-35-80-54-AC40-F5-3](#) [OSM51206E1N-0.8T](#) [OSW43020C1C](#) [MP161611032290](#) [MP-1616-2103-50-90](#) [KW CULPM1.TG-Z6RF7-ebvFfcbB46-65G5](#) [KW DMLS33.SG-Z6M7-EBVFFCBB46-8E8G-700-S](#) [XPGDWT-B1-0000-00EEA](#) [XHP70B-00-0000-0D0BP450E](#) [KW DMLN33.SG-7J7K-EBVFFCBB46-8E8G-200-S](#) [ASMT-MW05-NMNS1](#)