



Up to Category 4, EN 954-1 PNOZ 16



Safety relay for monitoring emergency stop pushbuttons, safety gates, safety mats and safe edges

Approvals

	PNOZ 16
	◆
	◆
	◆

Unit features

- ▶ Positive-guided relay outputs:
 - 2 safety contacts (N/O), instantaneous
- ▶ Connection options for:
 - E-STOP pushbutton
 - Safety gate limit switch
 - Reset button
 - Safe edges
 - Safety mats
- ▶ LED indicator for:
 - Switch status channel 1/2
 - Supply voltage
 - Detection of shorts across contacts on safety mat "EXT. FAULT"
- ▶ See order reference for unit types

The safety relay is not suitable for non-contact barriers because

- ▶ a dynamic start is not possible
- ▶ the unit can be started during the delay-on de-energisation time.

Safety features

The relay meets the following safety requirements:

- ▶ The circuit is redundant with built-in self-monitoring.
- ▶ The safety function remains effective in the case of a component failure.
- ▶ The correct opening and closing of the safety function relays is tested automatically in each on-off cycle.
- ▶ The transformer is short circuit-proof. An electronic fuse is used on a DC supply.

Unit description

The safety relay meets the requirements of EN 60947-5-1, EN 60204-1 and VDE 0113-1 and may be used in applications with

- ▶ E-STOP pushbuttons
- ▶ Safety gates
- ▶ Safety mats
- ▶ Safe edges

Block diagram

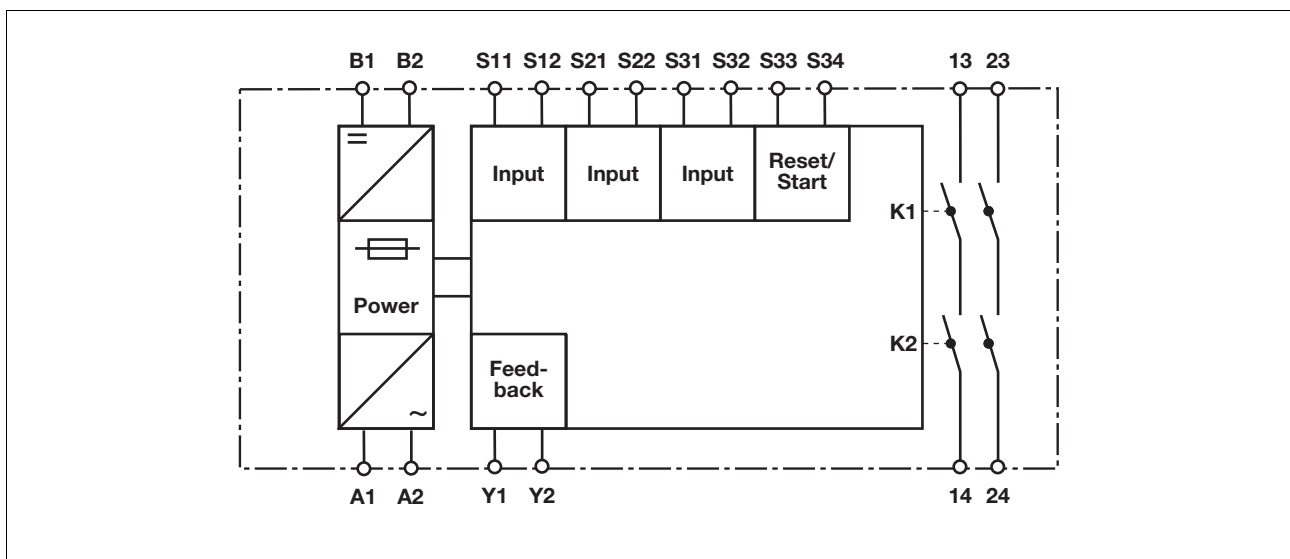

Up to Category 4, EN 954-1 PNOZ 16

Function description

- ▶ Single-channel operation: no redundancy in the input circuit, earth faults in the reset and input circuit are detected.
- ▶ Dual-channel operation with detection of shorts across contacts: redundant input circuit, detects
 - earth faults in the reset and input circuit,
- short circuits and shorts between contacts in the input circuit.
- ▶ When the safety mat is actuated, a short is formed between the inputs and internal fault detection is energised. The safety contacts open and the LED EXT.FAULT is lit. If the safety mat is cleared and supply voltage is maintained, the unit is ready for operation again once the recovery time has elapsed.
- ▶ Automatic start: Unit is active once the input circuit has been closed.
- ▶ Manual reset: Unit is active once the input circuit is closed and then the reset circuit is closed.
- ▶ Increase in the number of available contacts by connecting contact expansion modules or external contactors/relays.

Timing diagram

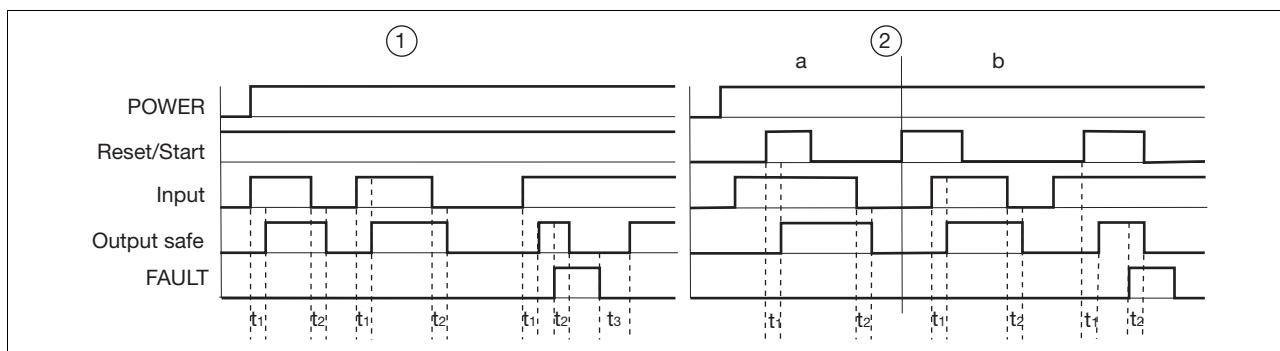

Key

- ▶ Power: Supply voltage
- ▶ Reset/start: Reset circuit S33-S34
- ▶ Input: Input circuits S11-S12, S21-S22, S31-S32
- ▶ Output safe: Safety contacts 13-14, 23-24
- ▶ FAULT: Short between contacts in the input circuit due to actuation of safety mat
- ▶ ①: Automatic reset
- ▶ ②: Manual reset
- ▶ a: Input circuit closes before reset circuit
- ▶ b: Reset circuit closes before input circuit
- ▶ t₁: Switch-on delay
- ▶ t₂: Delay-on de-energisation
- ▶ t₃: Recovery time after short across contacts

Wiring

Please note:

- ▶ Information given in the “Technical details” must be followed.
- ▶ Outputs 13-14, 23-24 are safety contacts.
- ▶ To prevent contact welding, a fuse should be connected before the output contacts (see technical details).
- ▶ Calculation of the max. cable runs I_{max} in the input circuit:

$$I_{\max} = \frac{R_{I_{\max}}}{R_l / \text{km}}$$

R_{I_{max}} = max. overall cable resistance (see technical details)

R_l /km = cable resistance/km

- ▶ Use copper wire that can withstand 60/75 °C.

- ▶ Sufficient fuse protection must be provided on all output contacts with capacitive and inductive loads.

Up to Category 4, EN 954-1 PNOZ 16

Preparing for operation

► Supply voltage

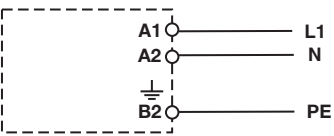
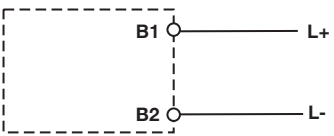

Supply voltage	AC	DC
		

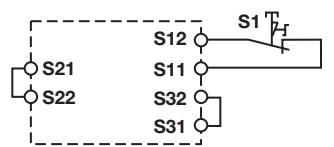
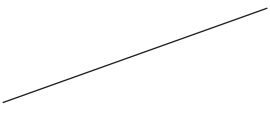
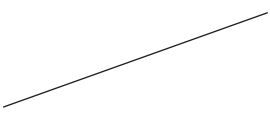
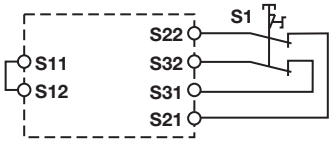
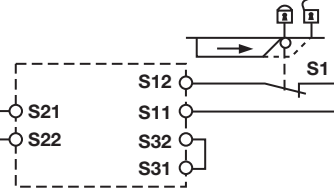
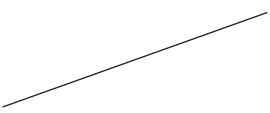
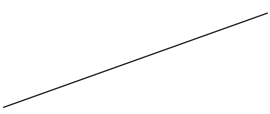
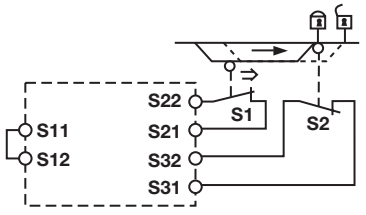
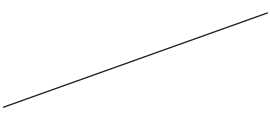
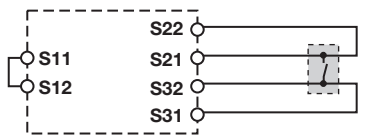
► Input circuit

Input circuit	Single-channel	Dual-channel
E-STOP without detection of shorts across contacts		
E-STOP with detection of shorts across contacts		
Safety gate without detection of shorts across contacts		
Safety gate with detection of shorts across contacts		
Safety gate with detection of shorts across contacts		

Up to Category 4, EN 954-1 PNOZ 16

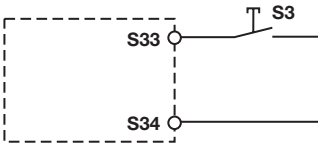
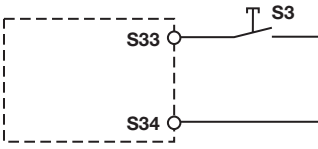

▶ Reset circuit

Reset circuit	E-STOP wiring (single-channel) Safety gate (single-channel)	E-STOP wiring (dual-channel) Safety gate (dual-channel)
Automatic reset		
Manual reset		

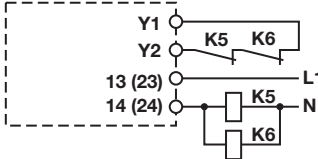
▶ Feedback loop

Feedback loop	
Contacts from external contactors	

▶ Key

S1/S2	E-STOP/safety gate switch
S3	Reset button
	Switch operated
	Gate open
	Gate closed

Up to Category 4, EN 954-1 PNOZ 16

Terminal configuration

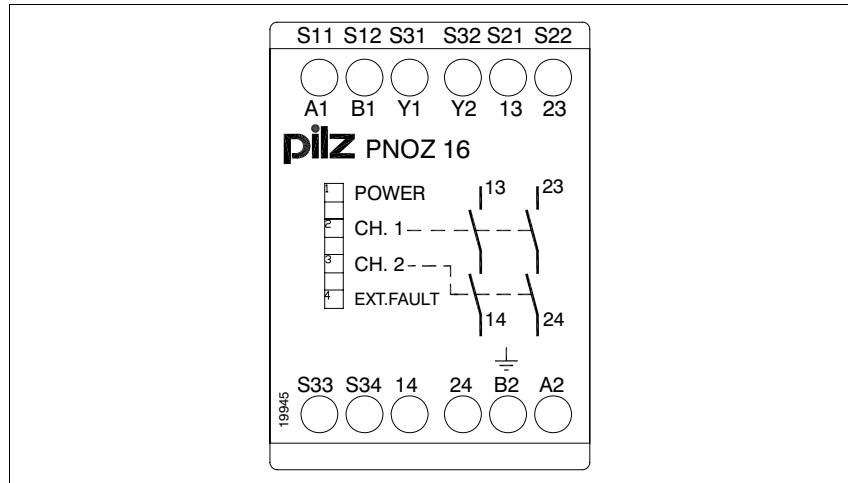

Installation

- ▶ The safety relay should be installed in a control cabinet with a protection type of at least IP54.
- ▶ Use the notch on the rear of the unit to attach it to a DIN rail.
- ▶ Ensure the unit is mounted securely on a vertical DIN rail (35 mm) by using a fixing element (e.g. retaining bracket or an end angle).

Dimensions

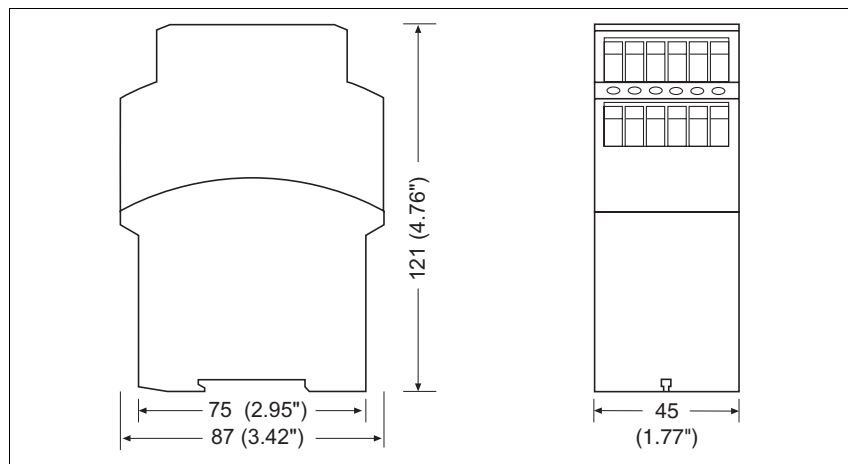

Up to Category 4, EN 954-1 PNOZ 16

Notice

This data sheet is only intended for use during configuration. For installation and operation, please refer to the operating instructions supplied with the unit.

Service life graph

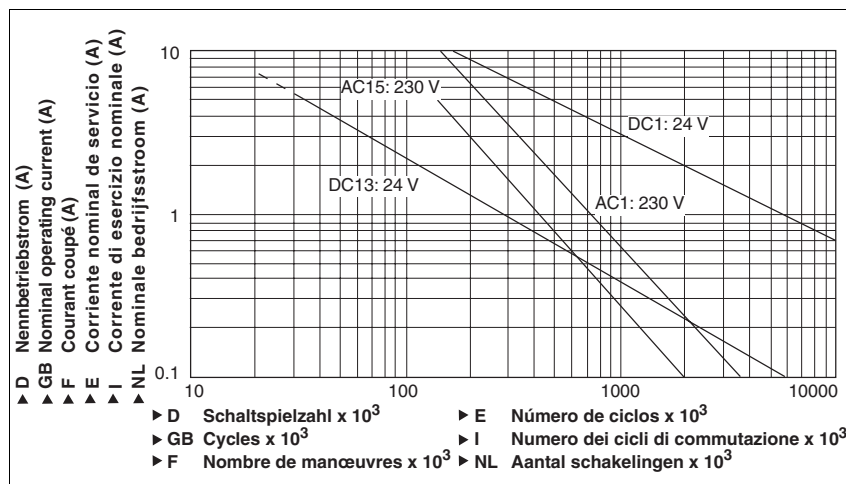

Technical details

Electrical data

Supply voltage	
Supply voltage U _B AC	24 V, 42 V, 48 V, 110 V, 115 V, 120 V, 230 V, 240 V
Supply voltage U _B DC	24 V
Voltage tolerance	-15 %/+10 %
Power consumption at U _B AC	3.5 VA
Power consumption at U _B DC	2.0 W
Frequency range AC	50 - 60 Hz
Residual ripple DC	20 %
Voltage and current at	
Input circuit DC: 24.0 V	25.0 mA
Reset circuit DC: 24.0 V	25.0 mA
Feedback loop DC: 24.0 V	25.0 mA
Number of output contacts	
Safety contacts (S) instantaneous:	2
Category of output contacts in accordance with EN 954-1, EN ISO 13849-1	
Safety contacts (S) instantaneous:	4
Utilisation category in accordance with EN 60947-4-1	
Safety contacts: AC1 at 240 V	I_{min}: 0.01 A, I_{max}: 8.0 A P_{max}: 2000 VA
Safety contacts: DC1 at 24 V	I_{min}: 0.01 A, I_{max}: 8.0 A P_{max}: 200 W
Utilisation category in accordance with EN 60947-5-1	
Safety contacts: AC15 at 230 V	I_{max}: 5.0 A
Safety contacts: DC13 at 24 V (6 cycles/min)	I_{max}: 6.0 A
Contact material	AgSnO₂ + 0.2 µm Au
External contact fuse protection (I _k = 1 kA) to EN 60947-5-1	
Blow-out fuse, quick	
Safety contacts:	10 A
Blow-out fuse, slow	
Safety contacts:	6 A
Circuit breaker 24 VAC/DC, characteristic B/C	
Safety contacts:	6 A
Safety mat resistance	80 Ohm

Up to Category 4, EN 954-1 PNOZ 16

Electrical data	
Max. overall cable resistance $R_{I\max}$ input circuits, reset circuits	
single-channel at U_B DC	40 Ohm
single-channel at U_B AC	40 Ohm
dual-channel with detect. of shorts across contacts at U_B DC	80 Ohm
dual-channel with detect. of shorts across contacts at U_B AC	80 Ohm
Times	
Switch-on delay	
with automatic reset typ.	230 ms
with automatic reset max.	350 ms
with automatic reset after power on typ.	310 ms
with automatic reset after power on max.	450 ms
with manual reset typ.	230 ms
with manual reset max.	350 ms
Delay-on de-energisation	
with E-STOP typ.	18 ms
with E-STOP max.	30 ms
with power failure typ.	50 ms
with power failure max.	80 ms
Recovery time at max. switching frequency 1/s	
after E-STOP	50 ms
after power failure	100 ms
Simultaneity, channel 1 and 2	∞
Supply interruption before de-energisation	20 ms
Environmental data	
EMC	EN 60947-5-1, EN 61000-6-2
Vibration to EN 60068-2-6	
Frequency	10 - 55 Hz
Amplitude	0.35 mm
Climatic suitability	EN 60068-2-78
Airgap creepage in accordance with EN 60947-1	
Pollution degree	2
Rated insulation voltage	250 V
Rated impulse withstand voltage	4.0 kV
Ambient temperature	-10 - 55 °C
Storage temperature	-40 - 85 °C
Protection type	
Mounting (e.g. cabinet)	IP54
Housing	IP40
Terminals	IP20
Mechanical data	
Housing material	
Housing	PPO UL 94 V0
Front	ABS UL 94 V0
Cross section of external conductors with screw terminals	
1 core flexible	0.20 - 4.00 mm ² , 24 - 10 AWG
2 core, same cross section, flexible:	
with crimp connectors, without insulating sleeve	0.20 - 2.50 mm ² , 24 - 14 AWG
without crimp connectors or with TWIN crimp connectors	0.20 - 2.50 mm ² , 24 - 14 AWG
Torque setting with screw terminals	0.60 Nm
Dimensions	
Height	87.0 mm
Width	45.0 mm
Depth	121.0 mm
Weight	350 g

Up to Category 4, EN 954-1 PNOZ 16

The standards current on **2008-06** apply.

Conventional thermal current

Number of contacts	I_{th} (A) at U_B DC	I_{th} (A) at U_B AC
1	8.00 A	8.00 A
2	6.00 A	6.00 A

Order reference

Type	Features	Terminals	Order no.
PNOZ 16	24 VAC/DC	Screw terminals	774 060
PNOZ 16	42 VAC	24 VDC Screw terminals	774 061
PNOZ 16	48 VAC	24 VDC Screw terminals	774 062
PNOZ 16	110 VAC	24 VDC Screw terminals	774 063
PNOZ 16	115 VAC	24 VDC Screw terminals	774 064
PNOZ 16	120 VAC	24 VDC Screw terminals	774 065
PNOZ 16	230 VAC	24 VDC Screw terminals	774 066
PNOZ 16	240 VAC	24 VDC Screw terminals	774 067

X-ON Electronics

Largest Supplier of Electrical and Electronic Components

Click to view similar products for [Emergency Stop Switches / E-Stop Switches](#) category:

Click to view products by [Pilz](#) manufacturer:

Other Similar products are found below :

[84-5021.2B40](#) [84-6830.0020](#) [A01ESSP8](#) [A22EL-M-24A-11B](#) [AVN302N-R](#) [A165E-S-01\(STOP\)](#) [AYLD2212602SN-R-TK962](#)
[AVLD39911N-R-24V](#) [A22Z-EG22](#) [A165E-SY](#) [3100.0110Y](#) [3050.1302Y](#) [3SE2243-0XX40](#) [3SK1111-2AB30](#) [3SK1211-1BB40](#) [44-710](#) [84-](#)
[6841.2B20](#) [84-6830.0040](#) [H3141AAKAA](#) [A165E-R-24D-01](#) [E3102AAAAB](#) [A22E-M-03](#) [ZA2BV05](#) [A22EL-M-T2-01](#) [951FY000-WO](#)
[ER6022-022N](#) [952+2000-00](#) [ES3S51653](#) [601+0000-OP](#) [E3101AAAAB](#) [84-5130.0040](#) [CS AR-05V024](#) [CS AR-22V024](#) [DS AE1VA](#) [DS](#)
[KB2A](#) [DS KB3A](#) [HE2G-21SHE-L-K](#) [HE6B-M211Y](#) [774191](#) [774316](#) [777760](#) [R1.100.0129.0 SMA0129- NO/NO](#) [R1.188.0640.0 SNV](#)
[4063KL-A](#) [R1.188.1810.0 SNA 4043K-A](#) [R1.188.1840.0 SNA 4043K-A](#) [SR BD40ALK-B02F](#) [AVLW39911D-R-120V](#) [AYD311NUG](#)
[AVLD32211DNUR](#) [84-5040.0020.0049](#)