

**GREEN MODE**
**RoHS**

Country of Origin : China  
 Operating Temperature : 0~40 [°C]  
 Dimension : 80x 58x 39 [mm]  
 Certified AC Plugs: EU, UK, USA/Japan/Taiwan, Aus, China, Korea  
 Efficiency level (ErP) : VI



Approvals / Marks :

**Specifications**

Model	Voltage DC [V]	Loading [A]	Max. Power [W]	Ripple / Noise [mV] p-p	Connector [mm]
SYS1588-3005-Wxx*	5	0~6	30	120	2.1x5.5x11
SYS1588-3609-Wxx*	9	0~4	36	120	2.1x5.5x11
SYS1588-4012-Wxx*	12	0~3.3	40	200	2.1x5.5x11
SYS1588-4015-Wxx*	15	0~2.6	40	200	2.1x5.5x11
SYS1588-4018-Wxx*	18	0~2.2	40	240	2.1x5.5x11
SYS1588-4024-Wxx*	24	0~1.6	40	240	2.1x5.5x11
SYS1588-4048-Wxx*	48	0~0.8	40	400	2.1x5.5x11

**Features:**

Certified plugs Wxx = W2E - Europe | W3U - England | W2 - USA, Canada, Japan, Taiwan | W2A - Australia | W2C - China | W2K - Korea  
 Output connector: standard: 2.1 x 5.5 x 11mm or customer requirement | Regulated Output With Low Ripple Noise | Safety Agency Requirements and EMI/EMS Certified  
 Private Label Marking Available | Modified and Custom Design Available | 2 Years Warranty

OUTPUT		CE	
Turn delay	5000ms max@AC low line input@output full load	EMC	2014/30/EU
Hold up time	8ms min@AC nominal input@output full load	LVD	2014/35/EU EN 60950-1:2006+A11+A1+A2+A2
Efficiency (Normal)	>87%@115v/60HZ,230V/50HZ input & Full load	<b>SAFETY</b>	
Transient response (dv,tmax)	0.4V dv max At AC nominal input loading from 20%load to 80% load 16ms tmax Dynamic rise time 10 us max,duty 40ms max,Dynamic load step is slew rate of 0.5A/us	CE   GS   cTUVus   FCC   RCM   PSE   EAC   CB	
Power out.Limit	40W	<b>OTHERS</b>	
Burn in limit	Full load 2 Hours	Dielectric Strength (Hi-pot)	I/P-O/P:3000VAC
Power consumption	0.1W max. At AC nominal input@output min load	M.T.B.F	500,000 Calculated Hours at 25°C, according to the MIL-HDBK-217F
INPUT		Cable Length	1370mm (4.5 feet) standard cable or as required
Voltage	(90~264)VAC	PLD (power line disturbance)	Line power surge   Line voltage SAG-more info on request
Frequency	(47~63)hz	Cooling method	Natural Convection Cooling
Current	1.5A rms@AC low line input and DC output full load	Housing material	PC + ABS
Inrush Surge Current (cold start)	40/60A max@power supply cold start,ambient temperature 25°C @115Vac/230Vac nominal AC input	Temperature coefficient:	<±0.5%/°C
leakage current	0.25mA Max	ENVIRONMENT	
PROTECTION		Temperature	Operating: 0~40°C / Storage: -20%~85%°C
Over current/ Short protection	The power supply will be auto recovered when over current or short circuit faults remove (fold back). Is defined as any output impedance of less than 0.1Ω.The power supply will be auto recovered when short circuit faults remove	Humidity	Operating: 8%~90%RH / Storage: 5%~95% RH non condensing
Over Voltage	The power supply will not be auto recovered when faults remove 110%-150%. (Voltage limit)	WEIGHT	
Input protection	F1:2A 250V Fuse The power supply shall be protected against power line surges and any abnormal condition	NW: 240g/pc + plug	
No Load protection	The power supply is provided with no load operation to prevent the power supply and system from damage.	GW:255g/pc + plug	
Protection class	II, (ITU-T K.21 Surge 6KV on request)	PACKING	
		Box	75 pcs/1 box

**Mechanical case specification:**

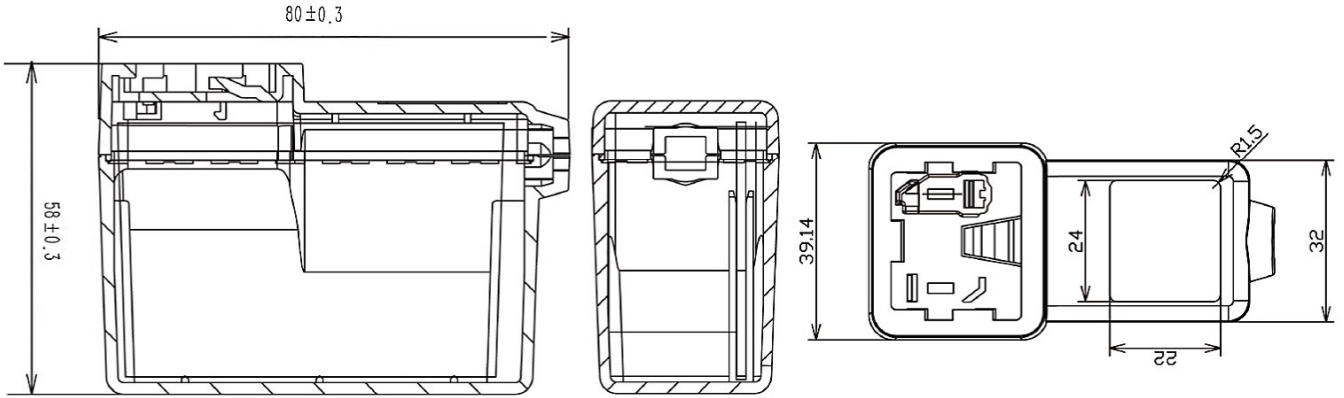

**Mechanical specification (country housing):**

US / Japan type (W2)

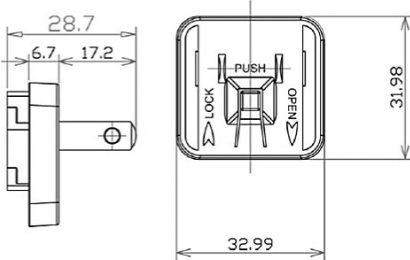

UK type (W3U)

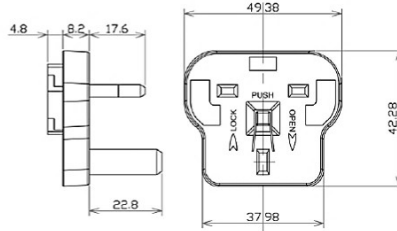

Europe type (W2E)

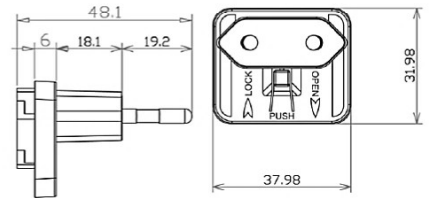

Australia type (W2A)

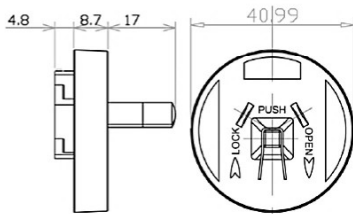

China type (W2C)

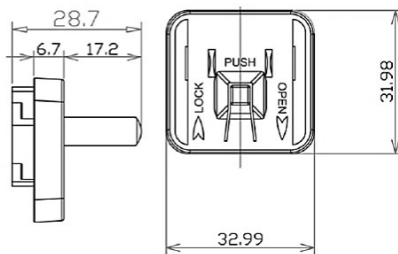

Korea type (W2K)

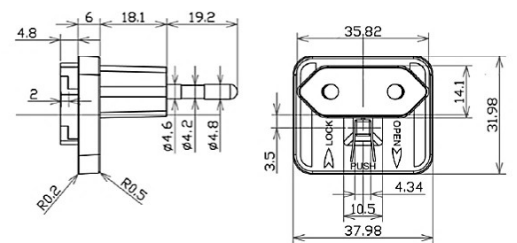

**Cable specification:**

for model SYS1588-3612

2468#18AWG\*2C|1370mm (wire cable)

for model SYS1588-3634

2468#20AWG\*2C|1370mm (wire cable)

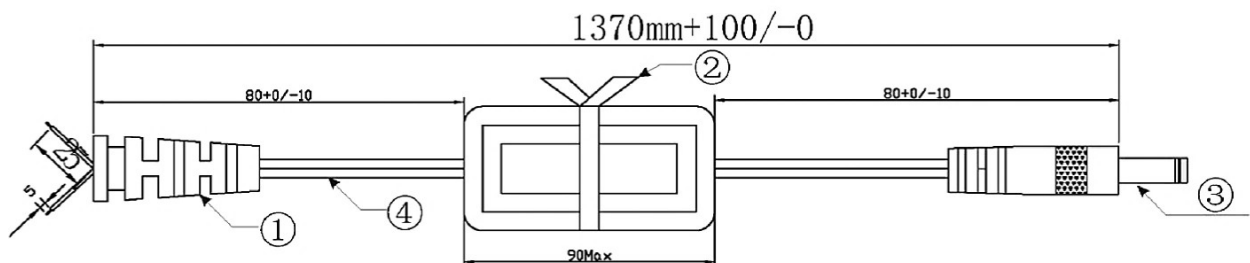

## X-ON Electronics

Largest Supplier of Electrical and Electronic Components

*Click to view similar products for [Wall Mount AC Adapters](#) category:*

*Click to view products by [Junction manufacturer](#):*

Other Similar products are found below :

[76000738](#) [76000756-B10](#) [ADP-163 E](#) [ADP-159 A](#) [PSAC05A-050L6](#) [RLMDT361800](#) [TE30A1803F01](#) [0650-00005](#) [P25A14E-R1C](#) [SWI24-12-N-P6R](#) [SWI24-24-N-ST](#) [TRH25033-A-02E01-Level-VI](#) [DA5-050US-B](#) [DA5-050UK-B](#) [RLMDT701800](#) [76000756](#) [DA5-050EU-B](#) [WSU120-2000-R13](#) [5V1A-USB](#) [AC-DC ADAPTER 160W](#) [WSU120-2000-13](#) [WSU150-0800-13](#) [76000980](#) [WSU075-3200-13](#) [WSU090-2500-13](#) [WSU050-2000-R13](#) [WSU240-1000-13](#) [WSU090-3500-R13](#) [WSU075-1500-13](#) [WSU050-3000-13](#) [WSU135-1330-13](#) [WSU045-1500-13](#) [WSU090-2500-R13](#) [WSU240-1500-13](#) [WSU180-0660-13](#) [WSU075-1500-R13](#) [WSU090-1300-13](#) [WSU180-1330-R13](#) [NTPS-24-TT-700](#) [BB-SMI1812VP230C1](#) [WSU150-1600-13](#) [WSU050-1500-13](#) [WSU090-0800-13](#) [WSU180-0450-13](#) [WSU150-0560-R13](#) [WSU135-0880-13](#) [WSU120-3000-13](#) [WSU120-1000-R13](#) [WSU090-1300-R13](#) [WSU060-4000-13](#)