

Eco-Rail Power supply 1-phase, primary switched IN: 90-264VAC OUT: 24V/1,3ADC

Input voltage: 90...264 V AC

Output: 24 V DC

Current: 1.3 A

Image

- stable output voltage, short-circuit and overload protected
- Wide voltage input
- touch protected (EN 60529) IP20

Approvals**Input**

Input voltage	90...264 V AC
Input current	0.7 A (115 V AC); 0.4 A (230 V AC)
Inrush current after 1 ms	<= 20 A
Primary fusing	max. 20 A
Frequency	50/60 Hz

Output

Output voltage	24 V DC (SELV), $\pm 1\%$
Nominal output current	1.3 A (+40 °C); 1.0 A (+55 °C)
Efficiency	84 % (115 V AC); 84 % (230 V AC)
Mains failure bridging	>= 25 ms (115 V AC); >= 130 ms (230 V AC)
Ripple	<= 20 mV eff
Spikes	<= 100 mV ss
Protection	Short-circuit and overload protected
LED display	LED (green) for output voltage
Parallel usage/serial usage	no/yes (max. 2 units)

General data

Standards	(EN 60950-1), (EN 61204-3), (EN 55022 B), (EN 61000-3-2)
Mounting method	DIN-rail mountable TH35 (EN 60715)
Relative humidity	20...90 %, no condensation
Temperature range	0...+40 °C, to +55 °C derating (storage temperature -20...+85 °C)
Dimensions H x W x D	125 x 50 x 70 mm

Commercial data

Gross weight	370
Net weight	370
Weight unit	gram
Basic unit	pc.
Customs tariff number	85044081
Unit (piece)	1
Limited value	1

Comments

Eco-Rail primary switch mode power supplies meet the (EN 61000-3-2) standard for harmonic current

All data on this data sheet was compiled carefully.

Liability regarding correctness, completeness, and actuality is limited to gross negligence. Created: 08/10

Circuit diagram

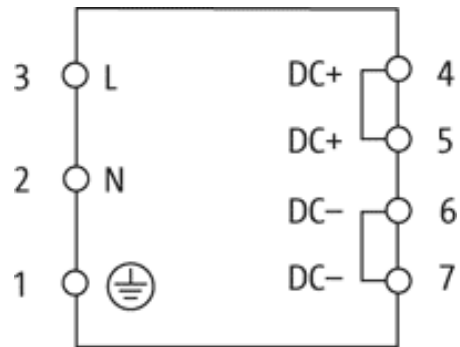

Dimension drawing

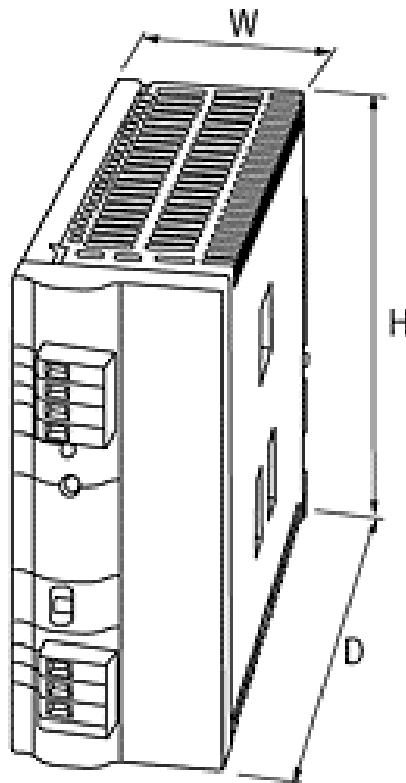

X-ON Electronics

Largest Supplier of Electrical and Electronic Components

Click to view similar products for [DIN Rail Power Supplies](#) category:

Click to view products by [Murr Elektronik](#) manufacturer:

Other Similar products are found below :

[PS-3015](#) [PSP-480S48](#) [PSR-SD25](#) [PS-S6024](#) [DR-45-24](#) [DRP048V120W1BA](#) [DVP01PU-S](#) [DVP06AD-S](#) [DVP06XA-S](#) [DVDPNET-SL](#)
[DVPDT01-S](#) [DVPPS01](#) [DVPPS02](#) [KHNA30F-5](#) [KHNA60F-24](#) [S8JX-G01524](#) [S8JX-G01548C](#) [S8JX-G03512D](#) [S8VS-09024B-F](#) [PS-6012](#)
[PS9Z-5R1G](#) [PS-C24024](#) [PSC-9648](#) [5607189](#) [KHNA30F-24](#) [KHNA480F-24](#) [KHNA90F-12](#) [KHNA90F-24](#) [DVP08ST11N](#) [DVPACAB530](#)
[DVPCOPM-SL](#) [DVPEN01-SL](#) [DVPPF01-S](#) [S8JX-G10012](#) [S8JX-G15024](#) [CBI1210A](#) [SS14011524](#) [S8JX-G01505C](#) [S8TS-06024-E1](#) [PS-](#)
[S2012](#) [PSW-12024](#) [PS-UPS40](#) [PSC-6024](#) [S8VS-48024A-F](#) [PSD-A60W12](#) [96PS-A120WDIN](#) [PSD-A60W48](#) [S8JX-G03515CD](#) [PSD-](#)
[A40W12](#) [PSD-A40W24](#)