

Selection diagram

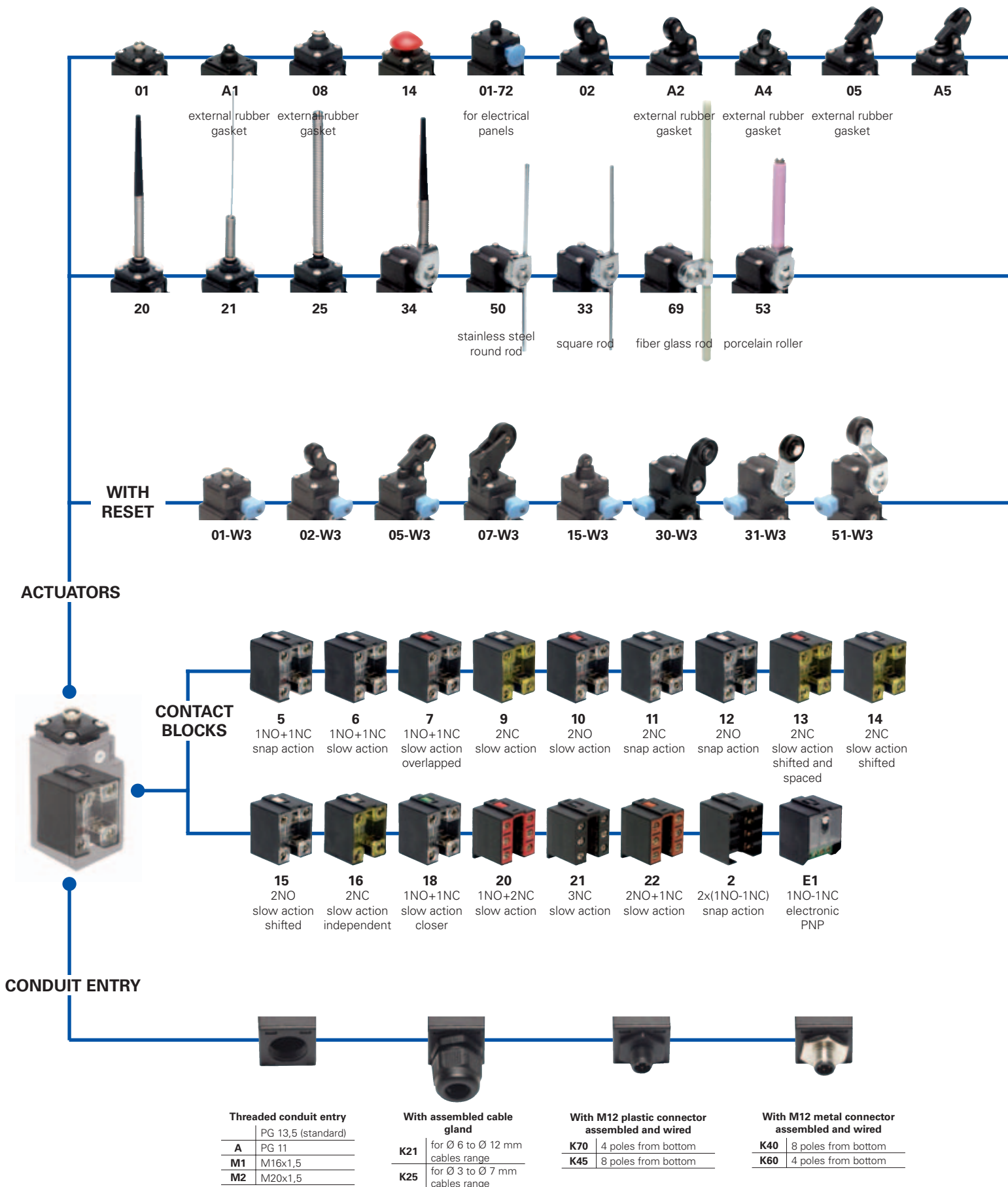

● product option
 → accessory sold separately

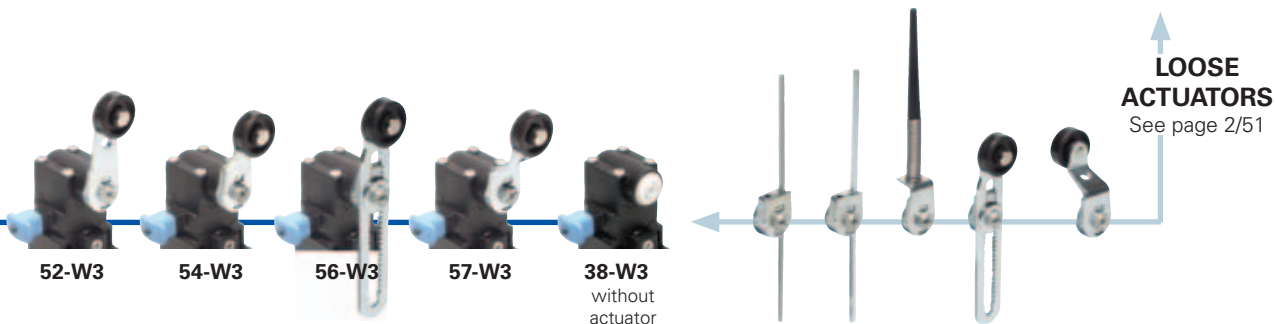
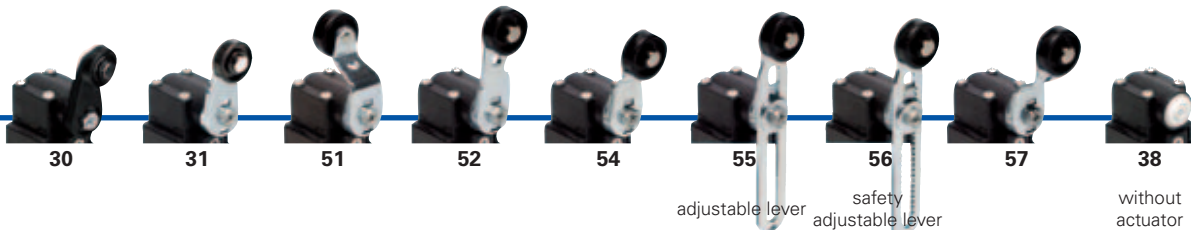
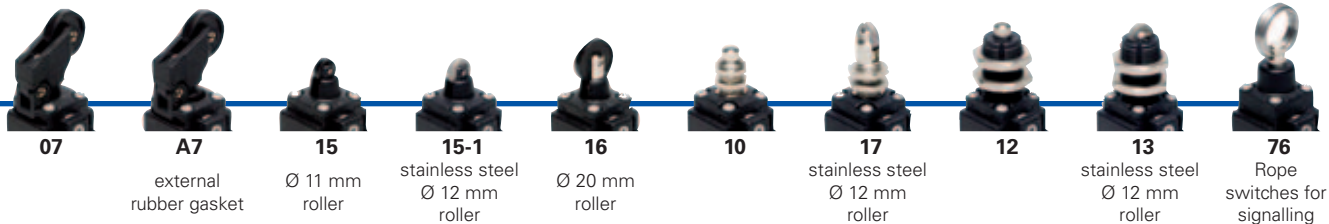

Code structure

Attention! The feasibility of a code number does not mean the effective availability of a product. Please contact our sales office.

article options
FR 502-1W3XGM2K70

Housing	
FR	polymer housing, one conduit entry
Contact blocks	
5	1NO+1NC, snap action
6	1NO+1NC, slow action
7	1NO+1NC, slow action overlapped
...
Actuators	
01	short plunger
02	roller lever
05	offset roller lever
...
Suffix	
	no suffix (standard)
1	with stainless steel roller: - Ø 12 mm for actuators A2, 02, A5, 05 - Ø 14 mm for actuators 30, 31, 51, 52, 54, 55, 56, 57
2	with Ø 35 mm polymer roller (see special loose actuators on page 2/52)
3	with Ø 50 mm rubber roller (see special loose actuators on page 2/52)
4	with Ø 50 mm overhanging rubber roller (see special loose actuators on page 2/52)

Preinstalled cable gland or connectors	
	no cable gland or connector (standard)
K21	with assembled cable gland suitable for Ø 6 to Ø 12 mm cables range
...
K70	with 4 poles M12 plastic connector
...

For the complete list of all combinations, please contact our technical office.

Threaded conduit entry	
	PG 13,5 (standard)
A	PG 11
M1	M16x1,5
M2	M20x1,5

Contacts type	
	silver contacts (standard)
G	silver contacts gold plated 1 µm (contact block 2 excluded)

External metallic parts	
	zinc plated steel (standard)
X	stainless steel

Reset hooking	
	without reset (standard)
W3	normal reset hooking





- 1
- 1A
- 1B
- 2
- 2A
- 2B
- 2C
- 2D
- 2E
- 3
- 3A
- 3B
- 3C
- 4
- 4A
- 4B
- 4C
- 4D
- 4E
- 4F
- 4G
- 4H
- 5
- 6



Main data

- Polymer housing, one conduit entry
- Protection degree IP67
- 17 contact blocks available
- 48 actuators available
- External stainless steel parts versions
- M12 assembled connector versions
- Silver contacts gold plated versions

Markings and quality marks:

Approval IMQ: EG610
 Approval UL: E131787
 Approval CCC: 2007010305230013
 Approval EZU: 1010151

Technical data

Housing

Made of glass-reinforced polymer, self-extinguishing, shock-proof thermoplastic resin and with double insulation 
 One threaded conduit entry
 Protection degree: IP67 according to EN 60529

General data

Ambient temperature: from -25°C to +80°C
 Version for operation in ambient temperature from -40°C to +80°C on request
 Max operating frequency: 3600 operations cycles¹/hour
 Mechanical endurance: 20 million operations cycles¹
 Assembling position: any
 Driving torque for installation: see pages 6/1-6/10
 (1) One operation cycle means two movements, one to close and one to open contacts, as foreseen by EN 60947-5-1 standard.

Cross section of the conductors (flexible copper wire)

Contact blocks 20, 21, 22, 33, 34:	min.	1 x 0,34 mm ²	(1 x AWG 22)
	max.	2 x 1,5 mm ²	(2 x AWG 16)
Contact blocks 5, 6, 7, 9, 10, 11, 12, 13, 14, 15, 16, 18:	min.	1 x 0,5 mm ²	(1 x AWG 20)
	max.	2 x 2,5 mm ²	(2 x AWG 14)
Contact block 2:	min.	1 x 0,5 mm ²	(1 x AWG 20)
	max.	2 x 1,5 mm ²	(2 x AWG 16)

In conformity with standards:

IEC 60947-5-1, EN 60947-5-1, EN 50047, IEC 60204-1, EN 60204-1, EN 1088, EN ISO 12100-1, EN ISO 12100-2, IEC 60529, EN 60529, NFC 63-140, VDE 0660-200, VDE 0113, CENELEC EN 50013.

Approvals:

IEC 60947-5-1, UL 508, GB14048.5-2001

In conformity with requirements requested by:

Low Voltage Directive 2006/95/EC, Machinery Directive 2006/42/EC and Electromagnetic Compatibility 2004/108/EC.

Positive contact opening in conformity with standards:

IEC 60947-5-1, EN 60947-5-1, VDE 0660-206.

Installation for safety applications:

Use only switches marked with the symbol . The safety circuit must always be connected with the **NC contacts** (normally closed contacts: 11-12, 21-22 or 31-32) as stated in the **standard EN 60947-5-1, encl. K, par. 2**. The switch must be actuated with **at least up to the positive opening travel** shown in the travels diagrams on page 6/6. The switch must be actuated **at least with the positive opening force**, shown in brackets, underneath each article, near the value of the min. force.

 **If not expressly indicated in this chapter, for the right installation and the correct utilization of all articles see requirements indicated from page 6/1 to page 6/10.**

	Electrical data	Utilization categories
without connector	Thermal current (I _{th}):	10 A
	Rated insulation voltage (U _i):	500 Vac 600 Vdc 400 Vac 500 Vdc for contact blocks 20, 21, 22, 33, 34
with 4 poles M12 connector	Thermal current (I _{th}):	4 A
	Rated insulation voltage (U _i):	250 Vac 300 Vdc fuse 4 A 500 V type gG
with 8 poles M12 connector	Thermal current (I _{th}):	2 A
	Rated insulation voltage (U _i):	30 Vac 36 Vdc fuse 2 A 500 V type gG
	Protection against short circuits:	
	Pollution degree:	
		Alternate current: AC15 (50...60 Hz)
		U _e (V) 250 400 500
		I _e (A) 6 4 1
		Direct current: DC13
		U _e (V) 24 125 250
		I _e (A) 6 1,1 0,4
		Alternate current: AC15 (50...60 Hz)
		U _e (V) 24 120 250
		I _e (A) 4 4 4
		Direct current: DC13
		U _e (V) 24 125 250
		I _e (A) 4 1,1 0,4
		Alternate current: AC15 (50...60 Hz)
		U _e (V) 24
		I _e (A) 2
		Direct current: DC13
		U _e (V) 24
		I _e (A) 2



Data type approved by IMQ, CCC and EZU

Rated insulation voltage (Ui): 500 Vac
400 Vac for contact blocks 20, 21, 22, 33, 34

Thermal current (Ith): 10 A

Protection against short circuits: fuse 10 A 500 V type aM

Protection degree: IP67

MV terminals (screw clamps)

Pollution degree 3

Utilization category: AC15

Operation voltage (Ue): 400 Vac (50 Hz)

Operation current (Ie): 3 A

Forms of the contact element: Za, Zb, Za+Za, Y+Y, X+X, Y+Y+X, Y+Y+Y, Y+X+X

Positive opening of contacts on contact block 5, 6, 7, 9, 11, 13, 14, 16, 18, 20, 21, 22, 33, 34

In conformity with standards: EN 60947-1, EN 60947-5-1 and subsequent modifications and completions, fundamental requirements of the Low Voltage Directive 2006/95/CE and subsequent modifications and completions.

Please contact our technical service for the list of approved products.

Data type approved by UL

Utilization categories Q300 (69 VA, 125-250 Vdc)
A600 (720 VA, 120-600 Vac)

Data of the housing type 1, 4X "indoor use only"; 12, 13

For all contact blocks except 2 and 3 use 60 or 75 °C copper (Cu) conductor and wire size No. 12-14 AWG. Terminal tightening torque of 7,1 lb in (0,8 Nm).
For contact blocks 2 and 3 use 60 or 75 °C copper (Cu) conductor and wire size No. 14 AWG. Terminal tightening torque of 12 lb in (1.4 Nm).

In conformity with standard: UL 508

Please contact our technical service for the list of approved products.

Adjustable levers

In switches with revolving lever it is possible to adjust the lever with 10° steps for the whole 360° range. The positive movement

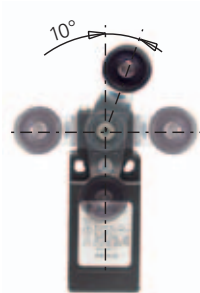

transmission is always guaranteed thanks to the particular geometrical coupling between the lever and the revolving shaft as prescribed for safety applications by the German standard BG-GS-ET-15.

Overturning levers

It's possible to fasten the lever on switches on straight or reverse side, maintaining the positive coupling.

In this way it is possible to obtain two different work plans of the lever.



Rotating heads

In all switches, it is possible to rotate the head in 90° steps.



Working operation of contact block 16 with independent contacts

The contact block 16 has two NC contacts, both with positive opening activated independently according to the lever turning direction.

Lever turned to left

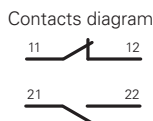

Lever not turned

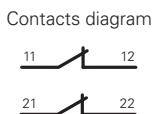

Lever turned to right

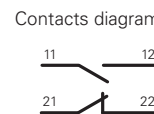

- 1
- 1A
- 1B
- 2
- 2A
- 2B
- 2C
- 2D
- 2E
- 3
- 3A
- 3B
- 3C
- 4
- 4A
- 4B
- 4C
- 4D
- 4E
- 4F
- 4G
- 4H
- 5
- 6

2B Position switches FR series

Contacts type:

- R** = snap action
- L** = slow action
- LO** = slow action overlapped
- LS** = slow action shifted
- LV** = slow action shifted and spaced
- LI** = slow action independent
- LA** = slow action closer
- ⏏** = electronic PNP

Contact blocks

	With external rubber gasket	With stainless steel roller on request	With external rubber gasket	With stainless steel roller on request
5	FR 501 → 1NO+1NC	FR 5A1 → 1NO+1NC	FR 502 → 1NO+1NC	FR 5A2 → 1NO+1NC
6	FR 601 → 1NO+1NC	FR 6A1 → 1NO+1NC	FR 602 → 1NO+1NC	FR 6A2 → 1NO+1NC
7	FR 701 → 1NO+1NC	FR 7A1 → 1NO+1NC	FR 702 → 1NO+1NC	FR 7A2 → 1NO+1NC
9	FR 901 → 2NC	FR 9A1 → 2NC	FR 902 → 2NC	FR 9A2 → 2NC
10	FR 1001 2NO	FR 10A1 2NO	FR 1002 2NO	FR 10A2 2NO
11	FR 1101 → 2NC	FR 11A1 → 2NC	FR 1102 → 2NC	FR 11A2 → 2NC
12	FR 1201 2NO	FR 12A1 2NO	FR 1202 2NO	FR 12A2 2NO
13	FR 1301 → 2NC	FR 13A1 → 2NC	FR 1302 → 2NC	FR 13A2 → 2NC
14	FR 1401 → 2NC	FR 14A1 → 2NC	FR 1402 → 2NC	FR 14A2 → 2NC
15	FR 1501 2NO	FR 15A1 2NO	FR 1502 2NO	FR 15A2 2NO
18	FR 1801 → 1NO+1NC	FR 18A1 → 1NO+1NC	FR 1802 → 1NO+1NC	FR 18A2 → 1NO+1NC
20	FR 2001 → 1NO+2NC	FR 20A1 → 1NO+2NC	FR 2002 → 1NO+2NC	FR 20A2 → 1NO+2NC
21	FR 2101 → 3NC	FR 21A1 → 3NC	FR 2102 → 3NC	FR 21A2 → 3NC
22	FR 2201 → 2NO+1NC	FR 22A1 → 2NO+1NC	FR 2202 → 2NO+1NC	FR 22A2 → 2NO+1NC
2	FR 201 2x(1NO-1NC)		FR 202 2x(1NO-1NC)	FR 2A2 2x(1NO-1NC)
E1	FR E101 1NO-1NC	FR E1A1 1NO-1NC	FR E102 1NO-1NC	FR E1A2 1NO-1NC
Max speed	page 6/5 - type 4	page 6/5 - type 4	page 6/5 - type 3	page 6/5 - type 3
Min. force	8 N (25 N →)	6 N (25 N →)	6 N (25 N →)	4,3 N (25 N →)
Travel diagrams	page 6/6 - group 1	page 6/6 - group 1	page 6/6 - group 2	page 6/6 - group 2

	With external rubber gasket	With stainless steel roller on request	With external rubber gasket	With stainless steel roller on request
5	FR 5A4 → 1NO+1NC	FR 505 → 1NO+1NC	FR 5A5 → 1NO+1NC	FR 507 → 1NO+1NC
6	FR 6A4 → 1NO+1NC	FR 605 → 1NO+1NC	FR 6A5 → 1NO+1NC	FR 607 → 1NO+1NC
7	FR 7A4 → 1NO+1NC	FR 705 → 1NO+1NC	FR 7A5 → 1NO+1NC	FR 707 → 1NO+1NC
9	FR 9A4 → 2NC	FR 905 → 2NC	FR 9A5 → 2NC	FR 907 → 2NC
10	FR 10A4 2NO	FR 1005 2NO	FR 10A5 2NO	FR 1007 2NO
11	FR 11A4 → 2NC	FR 1105 → 2NC	FR 11A5 → 2NC	FR 1107 → 2NC
12	FR 12A4 2NO	FR 1205 2NO	FR 12A5 2NO	FR 1207 2NO
13	FR 13A4 → 2NC	FR 1305 → 2NC	FR 13A5 → 2NC	FR 1307 → 2NC
14	FR 14A4 → 2NC	FR 1405 → 2NC	FR 14A5 → 2NC	FR 1407 → 2NC
15	FR 15A4 2NO	FR 1505 2NO	FR 15A5 2NO	FR 1507 2NO
18	FR 18A4 → 1NO+1NC	FR 1805 → 1NO+1NC	FR 18A5 → 1NO+1NC	FR 1807 → 1NO+1NC
20	FR 20A4 → 1NO+2NC	FR 2005 → 1NO+2NC	FR 20A5 → 1NO+2NC	FR 2007 → 1NO+2NC
21	FR 21A4 → 3NC	FR 2105 → 3NC	FR 21A5 → 3NC	FR 2107 → 3NC
22	FR 22A4 → 2NO+1NC	FR 2205 → 2NO+1NC	FR 22A5 → 2NO+1NC	FR 2207 → 2NO+1NC
2	FR 201 2x(1NO-1NC)	FR 205 2x(1NO-1NC)	FR 2A5 2x(1NO-1NC)	FR 207 2x(1NO-1NC)
E1	FR E1A4 1NO-1NC	FR E105 1NO-1NC	FR E1A5 1NO-1NC	FR E107 1NO-1NC
Max speed	page 6/5 - type 4	page 6/5 - type 3	page 6/5 - type 3	page 6/5 - type 3
Min. force	6 N (25 N →)	6 N (25 N →)	4,3 N (25 N →)	4 N (25 N →)
Travel diagrams	page 6/6 - group 1	page 6/6 - group 2	page 6/6 - group 2	page 6/6 - group 3

Accessories See page 5/1

All measures in the drawings are in mm



- Contacts type:
- R** = snap action
 - L** = slow action
 - LO** = slow action overlapped
 - LS** = slow action shifted
 - LV** = slow action shifted and spaced
 - LI** = slow action independent
 - LA** = slow action closer
 - A** = electronic PNP

Contact blocks

	With external rubber gasket	With external rubber gasket	Fixed only by threaded head in vertical position	
5	R FR 5A7	FR 508	FR 510	FR 512
6	L FR 6A7	FR 608	FR 610	FR 612
7	LO FR 7A7	FR 708	FR 710	FR 712
9	L FR 9A7	FR 908	FR 910	FR 912
10	L FR 10A7	FR 1008	FR 1010	FR 1012
11	R FR 11A7	FR 1108	FR 1110	FR 1112
12	R FR 12A7	FR 1208	FR 1210	FR 1212
13	LV FR 13A7	FR 1308	FR 1310	FR 1312
14	LS FR 14A7	FR 1408	FR 1410	FR 1412
15	LS FR 15A7	FR 1508	FR 1510	FR 1512
18	LA FR 18A7	FR 1808	FR 1810	FR 1812
20	L FR 20A7	FR 2008	FR 2010	FR 2012
21	L FR 21A7	FR 2108	FR 2110	FR 2112
22	L FR 22A7	FR 2208	FR 2210	FR 2212
2	R FR 2A7	FR 208	FR 210	FR 212
E1	A FR E1A7	FR E108	FR E110	FR E112
Max speed	page 6/5 - type 3	page 6/5 - type 4	page 6/5 - type 4	page 6/5 - type 4
Min. force	3 N (25 N ⊕)	8 N (25 N ⊕)	8 N (25 N ⊕)	8 N (25 N ⊕)
Travel diagrams	page 6/6 - group 3	page 6/6 - group 1	page 6/6 - group 1	page 6/6 - group 1

	Ø 11 mm polymer roller	Ø 12 mm stainless steel roller	
5	R FR 513	FR 514	FR 515-1
6	L FR 613	FR 614	FR 615-1
7	LO FR 713	FR 714	FR 715-1
9	L FR 913	FR 914	FR 915-1
10	L FR 1013	FR 1014	FR 1015-1
11	R FR 1113	FR 1114	FR 1115-1
12	R FR 1213	FR 1214	FR 1215-1
13	LV FR 1313	FR 1314	FR 1315-1
14	LS FR 1413	FR 1414	FR 1415-1
15	LS FR 1513	FR 1514	FR 1515-1
18	LA FR 1813	FR 1814	FR 1815-1
20	L FR 2013	FR 2014	FR 2015-1
21	L FR 2113	FR 2114	FR 2115-1
22	L FR 2213	FR 2214	FR 2215-1
2	R FR 213	FR 214	FR 215-1
E1	A FR E113	FR E114	FR E115-1
Max speed	page 6/5 - type 2	page 6/5 - type 4	page 6/5 - type 2
Min. force	8 N (25 N ⊕)	8 N (25 N ⊕)	8 N (25 N ⊕)
Travel diagrams	page 6/6 - group 1	page 6/6 - group 1	page 6/6 - group 1

Items with code on the green background are available in stock

2B Position switches FR series

Contacts type:

- R** = snap action
- L** = slow action
- LO** = slow action overlapped
- LS** = slow action shifted
- LV** = slow action shifted and spaced
- LI** = slow action independent
- LA** = slow action closer
- ⏏** = electronic PNP

Contact blocks

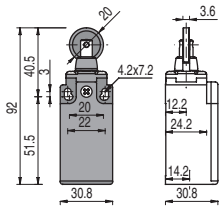

Fixed only by threaded head in vertical position

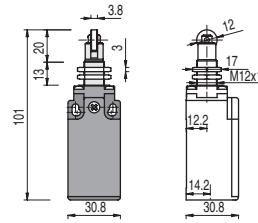

With external rubber gasket

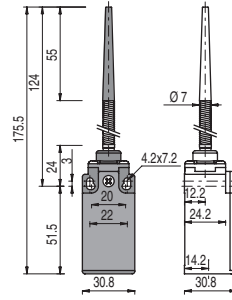

With external rubber gasket

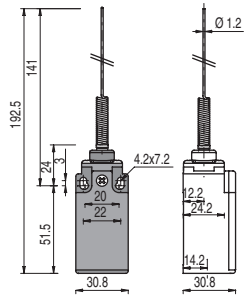

5	R	FR 516	⊕ 1NO+1NC	FR 517	⊕ 1NO+1NC	FR 520	1NO+1NC	FR 521	1NO+1NC
6	L	FR 616	⊕ 1NO+1NC	FR 617	⊕ 1NO+1NC				
7	LO	FR 716	⊕ 1NO+1NC	FR 717	⊕ 1NO+1NC				
9	L	FR 916	⊕ 2NC	FR 917	⊕ 2NC				
10	L	FR 1016	2NO	FR 1017	2NO	FR 1020	2NO	FR 1021	2NO
11	R	FR 1116	⊕ 2NC	FR 1117	⊕ 2NC				
12	R	FR 1216	2NO	FR 1217	2NO	FR 1220	2NO	FR 1221	2NO
13	LV	FR 1316	⊕ 2NC	FR 1317	⊕ 2NC				
14	LS	FR 1416	⊕ 2NC	FR 1417	⊕ 2NC				
15	LS	FR 1516	2NO	FR 1517	2NO				
18	LA	FR 1816	⊕ 1NO+1NC	FR 1817	⊕ 1NO+1NC	FR 1820	1NO+1NC	FR 1821	1NO+1NC
20	L	FR 2016	⊕ 1NO+2NC	FR 2017	⊕ 1NO+2NC	FR 2020	1NO+2NC	FR 2021	1NO+2NC
21	L	FR 2116	⊕ 3NC	FR 2117	⊕ 3NC	FR 2120	3NC	FR 2121	3NC
22	L	FR 2216	⊕ 2NO+1NC	FR 2217	⊕ 2NO+1NC	FR 2220	2NO+1NC	FR 2221	2NO+1NC
2	R	FR 216	2x(1NO-1NC)	FR 217	2x(1NO-1NC)	FR 220	2x(1NO-1NC)	FR 221	2x(1NO-1NC)
E1	⏏	FR E116	1NO-1NC	FR E117	1NO-1NC	FR E120	1NO-1NC	FR E121	1NO-1NC
Max speed		page 6/5 - type 2		page 6/5 - type 2		1 m/s		1 m/s	
Min. force		8 N (25 N ⊕)		8 N (25 N ⊕)		0,07 Nm		0,07 Nm	
Travel diagrams		page 6/6 - group 1		page 6/6 - group 1		page 6/6 - group 4		page 6/6 - group 4	

With external rubber gasket

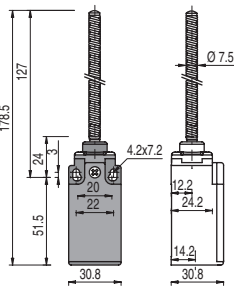

With Ø 20 mm stainless steel roller on request

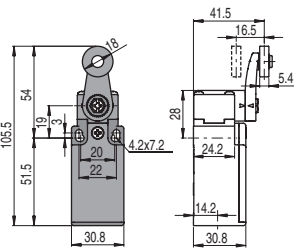

Other rollers available. See page 2/52

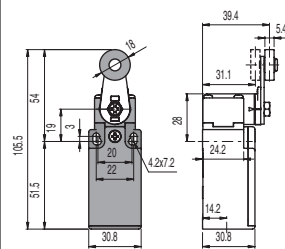

3x3 mm square rod

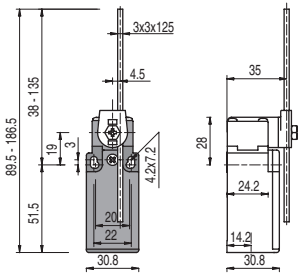

Contact blocks

5	R	FR 525	1NO+1NC	FR 530	⊕ 1NO+1NC	FR 531	⊕ 1NO+1NC	FR 533	1NO+1NC
6	L			FR 630	⊕ 1NO+1NC	FR 631	⊕ 1NO+1NC	FR 633	1NO+1NC
7	LO			FR 730	⊕ 1NO+1NC	FR 731	⊕ 1NO+1NC	FR 733	1NO+1NC
9	L			FR 930	⊕ 2NC	FR 931	⊕ 2NC	FR 933	2NC
10	L	FR 1025	2NO	FR 1030	2NO	FR 1031	2NO	FR 1033	2NO
11	R			FR 1130	⊕ 2NC	FR 1131	⊕ 2NC	FR 1133	2NC
12	R	FR 1225	2NO	FR 1230	2NO	FR 1231	2NO	FR 1233	2NO
13	LV			FR 1330	⊕ 2NC	FR 1331	⊕ 2NC	FR 1333	2NC
14	LS			FR 1430	⊕ 2NC	FR 1431	⊕ 2NC	FR 1433	2NC
15	LS			FR 1530	2NO	FR 1531	2NO	FR 1533	2NO
16	LI			FR 1630	⊕ 2NC	FR 1631	⊕ 2NC	FR 1633	2NC
18	LA	FR 1825	1NO+1NC	FR 1830	⊕ 1NO+1NC	FR 1831	⊕ 1NO+1NC	FR 1833	1NO+1NC
20	L	FR 2025	1NO+2NC	FR 2030	⊕ 1NO+2NC	FR 2031	⊕ 1NO+2NC	FR 2033	1NO+2NC
21	L	FR 2125	3NC	FR 2130	⊕ 3NC	FR 2131	⊕ 3NC	FR 2133	3NC
22	L	FR 2225	2NO+1NC	FR 2230	⊕ 2NO+1NC	FR 2231	⊕ 2NO+1NC	FR 2233	2NO+1NC
2	R	FR 225	2x(1NO-1NC)	FR 230	2x(1NO-1NC)	FR 231	2x(1NO-1NC)	FR 233	2x(1NO-1NC)
E1	⏏	FR E125	1NO-1NC	FR E130	1NO-1NC	FR E131	1NO-1NC	FR E133	1NO-1NC
Max speed		1 m/s		page 6/5 - type 1		page 6/5 - type 1		1,5 m/s	
Min. force		0,12 Nm		0,06 Nm (0,25 Nm ⊕)		0,06 Nm (0,25 Nm ⊕)		0,06 Nm	
Travel diagrams		page 6/6 - group 4		page 6/6 - group 5		page 6/6 - group 5		page 6/6 - group 5	

Accessories See page 5/1



Contacts type:

- R** = snap action
- L** = slow action
- LO** = slow action overlapped
- LS** = slow action shifted
- LV** = slow action shifted and spaced
- LI** = slow action independent
- LA** = slow action closer
- A** = electronic PNP

Contact blocks

		FR 534	1NO+1NC	FR 550	1NO+1NC	FR 551	1NO+1NC	FR 552	1NO+1NC
5	R	FR 534	1NO+1NC	FR 550	1NO+1NC	FR 551	1NO+1NC	FR 552	1NO+1NC
6	L	FR 634	1NO+1NC	FR 650	1NO+1NC	FR 651	1NO+1NC	FR 652	1NO+1NC
7	LO	FR 734	1NO+1NC	FR 750	1NO+1NC	FR 751	1NO+1NC	FR 752	1NO+1NC
9	L	FR 934	2NC	FR 950	2NC	FR 951	2NC	FR 952	2NC
10	L	FR 1034	2NO	FR 1050	2NO	FR 1051	2NO	FR 1052	2NO
11	R	FR 1134	2NC	FR 1150	2NC	FR 1151	2NC	FR 1152	2NC
12	R	FR 1234	2NO	FR 1250	2NO	FR 1251	2NO	FR 1252	2NO
13	LV	FR 1334	2NC	FR 1350	2NC	FR 1351	2NC	FR 1352	2NC
14	LS	FR 1434	2NC	FR 1450	2NC	FR 1451	2NC	FR 1452	2NC
15	LS	FR 1534	2NO	FR 1550	2NO	FR 1551	2NO	FR 1552	2NO
16	LI	FR 1634	2NC	FR 1650	2NC	FR 1651	2NC	FR 1652	2NC
18	LA	FR 1834	1NO+1NC	FR 1850	1NO+1NC	FR 1851	1NO+1NC	FR 1852	1NO+1NC
20	L	FR 2034	1NO+2NC	FR 2050	1NO+2NC	FR 2051	1NO+2NC	FR 2052	1NO+2NC
21	L	FR 2134	3NC	FR 2150	3NC	FR 2151	3NC	FR 2152	3NC
22	L	FR 2234	2NO+1NC	FR 2250	2NO+1NC	FR 2251	2NO+1NC	FR 2252	2NO+1NC
2	R	FR 234	2x(1NO-1NC)	FR 250	2x(1NO-1NC)	FR 251	2x(1NO-1NC)	FR 252	2x(1NO-1NC)
E1	A	FR E134	1NO-1NC	FR E150	1NO-1NC	FR E151	1NO-1NC	FR E152	1NO-1NC
Max speed		1,5 m/s		1,5 m/s		page 6/5 - type 1		page 6/5 - type 1	
Min. force		0,06 Nm		0,06 Nm		0,06 Nm (0,25 Nm ⊕)		0,06 Nm (0,25 Nm ⊕)	
Travel diagrams		page 6/6 - group 5		page 6/6 - group 5		page 6/6 - group 5		page 6/6 - group 5	

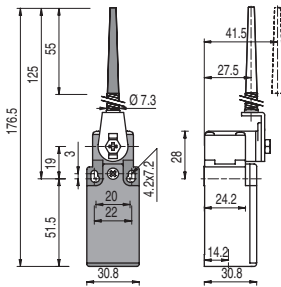

Ø 3 mm stainless steel round rod

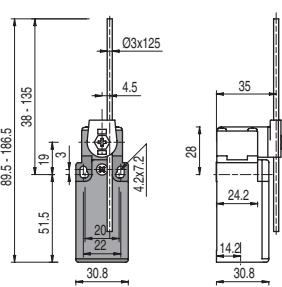

Other rollers available. See page 2/52

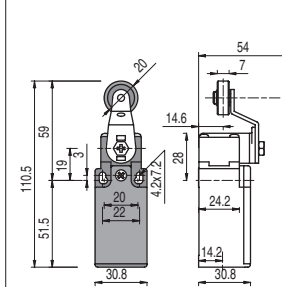

Other rollers available. See page 2/52

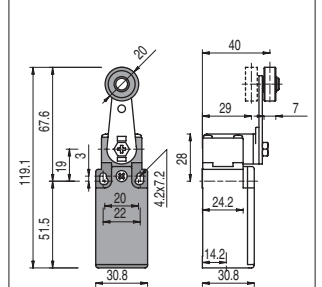

Contact blocks

		FR 553-E0V9	1NO+1NC	FR 554	1NO+1NC	FR 555	1NO+1NC	FR 556	1NO+1NC
5	R	FR 553-E0V9	1NO+1NC	FR 554	1NO+1NC	FR 555	1NO+1NC	FR 556	1NO+1NC
6	L	FR 653-E0V9	1NO+1NC	FR 654	1NO+1NC	FR 655	1NO+1NC	FR 656	1NO+1NC
7	LO	FR 753-E0V9	1NO+1NC	FR 754	1NO+1NC	FR 755	1NO+1NC	FR 756	1NO+1NC
9	L	FR 953-E0V9	2NC	FR 954	2NC	FR 955	2NC	FR 956	2NC
10	L	FR 1053-E0V9	2NO	FR 1054	2NO	FR 1055	2NO	FR 1056	2NO
11	R	FR 1253-E0V9	2NO	FR 1154	2NC	FR 1155	2NC	FR 1156	2NC
12	R	FR 1253-E0V9	2NO	FR 1254	2NO	FR 1255	2NO	FR 1256	2NO
13	LV	FR 1353-E0V9	2NC	FR 1354	2NC	FR 1355	2NC	FR 1356	2NC
14	LS	FR 1453-E0V9	2NC	FR 1454	2NC	FR 1455	2NC	FR 1456	2NC
15	LS	FR 1553-E0V9	2NO	FR 1554	2NO	FR 1555	2NO	FR 1556	2NO
16	LI	FR 1653-E0V9	2NC	FR 1654	2NC	FR 1655	2NC	FR 1656	2NC
18	LA	FR 1853-E0V9	1NO+1NC	FR 1854	1NO+1NC	FR 1855	1NO+1NC	FR 1856	1NO+1NC
20	L	FR 2053-E0V9	1NO+2NC	FR 2054	1NO+2NC	FR 2055	1NO+2NC	FR 2056	1NO+2NC
21	L	FR 2153-E0V9	3NC	FR 2154	3NC	FR 2155	3NC	FR 2156	3NC
22	L	FR 2253-E0V9	2NO+1NC	FR 2254	2NO+1NC	FR 2255	2NO+1NC	FR 2256	2NO+1NC
2	R	FR 253-E0	2x(1NO-1NC)	FR 254	2x(1NO-1NC)	FR 255	2x(1NO-1NC)	FR 256	2x(1NO-1NC)
E1	A	FR E153-E0V9	1NO-1NC	FR E154	1NO-1NC	FR E155	1NO-1NC	FR E156	1NO-1NC
Max speed		0,5 m/s		page 6/5 - type 1		page 6/5 - type 1		page 6/5 - type 1	
Min. force		0,03 Nm (0,25 Nm ⊕)		0,06 Nm (0,25 Nm ⊕)		0,06 Nm (0,25 Nm ⊕)		0,06 Nm (0,25 Nm ⊕)	
Travel diagrams		page 6/6 - group 6		page 6/6 - group 5		page 6/6 - group 5		page 6/6 - group 5	

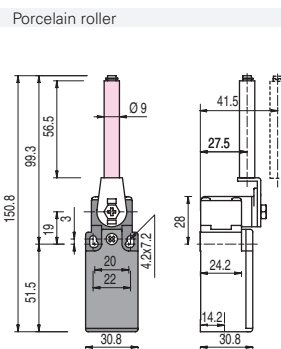

Other rollers available. See page 2/52

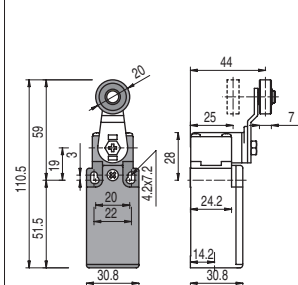

Other rollers available. See page 2/52

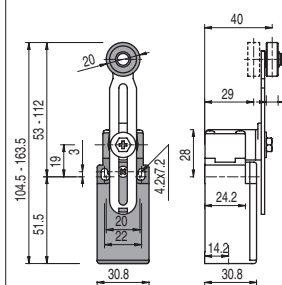

Other rollers available. See page 2/52

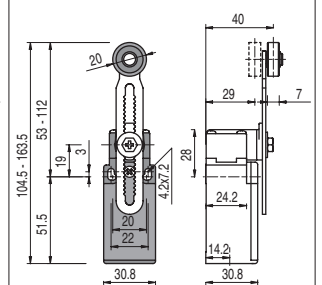

Items with code on the green background are available in stock

(1) Positive opening only with lever adjusted on the max. See page 2/51

2B Position switches FR series

Contacts type:

- R** = snap action
- L** = slow action
- LO** = slow action overlapped
- LS** = slow action shifted
- LV** = slow action shifted and spaced
- LI** = slow action independent
- LA** = slow action closer
- A** = electronic PNP

Contact blocks

Other rollers available. See page 2/52

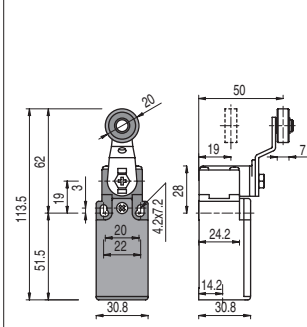

Fiber glass rod

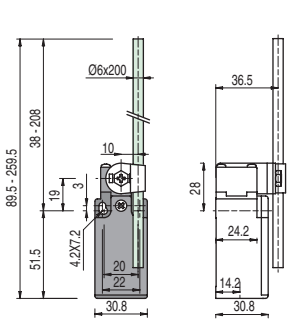

Rope switches for signalling

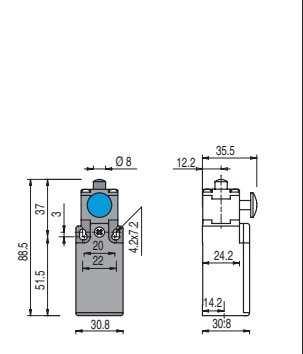
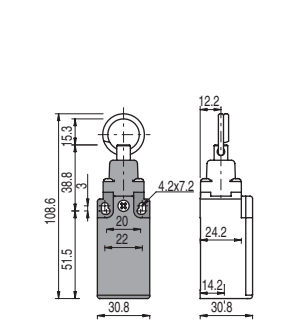

5	R	FR 557	1NO+1NC	FR 569	1NO+1NC	FR 576	1NO+1NC	FR 501-72	1NO+1NC
6	L	FR 657	1NO+1NC	FR 669	1NO+1NC	FR 676	1NO+1NC		
7	LO	FR 757	1NO+1NC	FR 769	1NO+1NC	FR 776	1NO+1NC		
9	L	FR 957	2NC	FR 969	2NC	FR 976	2NO		
10	L	FR 1057	2NO	FR 1069	2NO	FR 1076	2NC	FR 1001-72	2NO
11	R	FR 1157	2NC	FR 1169	2NC	FR 1176	2NO	This switch can be installed on doors of electrical boards. It is used to switch on possible signal devices, once the door is open (e.g. three-phase flashing devices, etc.) The operator assigned to the board maintenance may simulate the closing of the door by pushing the blue push button. At the end of the maintenance the functionality of the switch will be automatically reestablished easily by closing the door of the board.	
12	R	FR 1257	2NO	FR 1269	2NO	FR 1276	2NC		
13	LV	FR 1357	2NC	FR 1369	2NC	FR 1376	2NO		
14	LS	FR 1457	2NC	FR 1469	2NC	FR 1476	2NO		
15	LS	FR 1557	2NO	FR 1569	2NO	FR 1576	2NC		
16	LI	FR 1657	2NC	FR 1669	2NC				
18	LA	FR 1857	1NO+1NC	FR 1869	1NO+1NC	FR 1876	1NO+1NC		
20	L	FR 2057	1NO+2NC	FR 2069	1NO+2NC	FR 2076	2NO+1NC		
21	L	FR 2157	3NC	FR 2169	3NC	FR 2176	3NO		
22	L	FR 2257	2NO+1NC	FR 2269	2NO+1NC	FR 2276	1NO+2NC		
2	R	FR 257	2x(1NO-1NC)	FR 269	2x(1NO-1NC)	FR 276	2x(1NO-1NC)		
E1	A	FR E157	1NO-1NC	FR E169	1NO-1NC				
Max speed		page 6/5 - type 1		1,5 m/s		0,5 m/s		page 6/5 - type 4	
Min. force		0,06 Nm (0,25 Nm ⊕)		0,06 Nm		initial 20 N - final 40 N		8 N (25 N ⊕)	
Travel diagrams		page 6/6 - group 5		page 6/6 - group 5		page 6/6 - group 7		page 6/6 - group 1	

Position switches FR series with reset



Pizzato Elettrica has developed an innovative reset device code W3 to make perfectly simultaneous the actuator and the contact block tripping. The new device is a block inserted between the switch body and the head, and could be rotated independently from this last one. This new device has following advantages:

- * The reset device integrate in any standard actuation head
- * Contact blocks with snap action are no more necessary because the tripping movement is made by the reset device itself
- * Unlike some previous versions, the reset device can be rotated independently from the head for the maximum flexibility during the assembling.

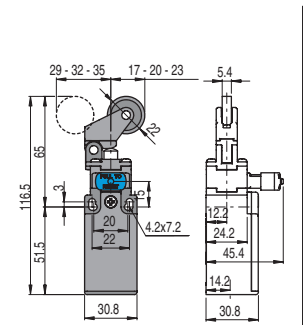
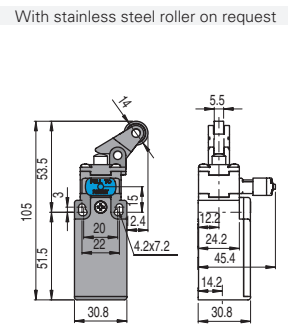
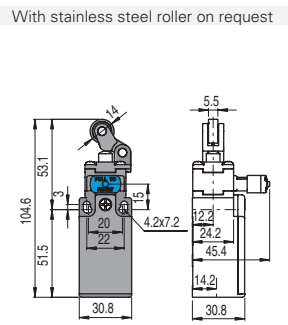
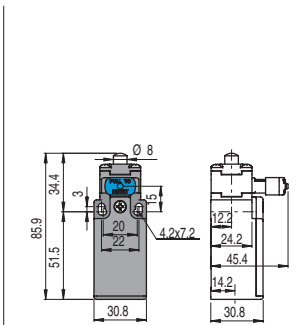

Contact blocks

6	L	FR 601-W3	1NO+1NC	FR 602-W3	1NO+1NC	FR 605-W3	1NO+1NC	FR 607-W3	1NO+1NC
9	L	FR 901-W3	2NC	FR 902-W3	2NC	FR 905-W3	2NC	FR 907-W3	2NC
10	L	FR 1001-W3	2NO	FR 1002-W3	2NO	FR 1005-W3	2NO	FR 1007-W3	2NO
20	L	FR 2001-W3	1NO+2NC	FR 2002-W3	1NO+2NC	FR 2005-W3	1NO+2NC	FR 2007-W3	1NO+2NC
21	L	FR 2101-W3	3NC	FR 2102-W3	3NC	FR 2105-W3	3NC	FR 2107-W3	3NC
22	L	FR 2201-W3	2NO+1NC	FR 2202-W3	2NO+1NC	FR 2205-W3	2NO+1NC	FR 2207-W3	2NO+1NC
2	R	FR 201-W3	2NO+2NC	FR 202-W3	2NO+2NC	FR 205-W3	2NO+2NC	FR 207-W3	2NO+2NC
Max speed		page 6/5 - type 4		page 6/5 - type 3		page 6/5 - type 3		page 6/5 - type 3	
Min. force		8 N (25 N ⊕)		6 N (25 N ⊕)		6 N (25 N ⊕)		4 N (25 N ⊕)	
Travel diagrams		page 6/7 - group 1		page 6/7 - group 2		page 6/7 - group 2		page 6/7 - group 3	

Accessories See page 5/1



Contacts type:

- R** = snap action
- L** = slow action

With stainless steel roller on request

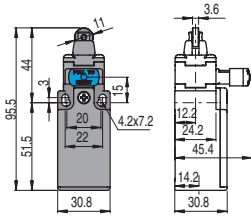

With Ø 20 mm stainless steel roller on request

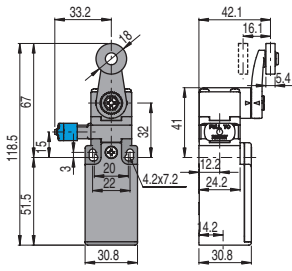

Other rollers available. See page 2/52

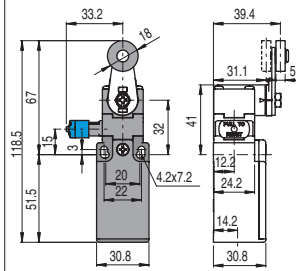

Other rollers available. See page 2/52

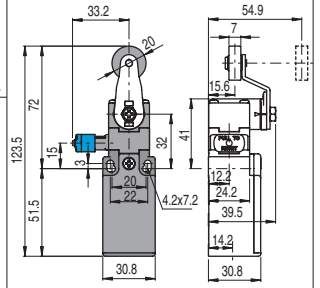

Contact blocks

6	L	FR 615-W3	➔ 1NO+1NC	FR 630-W3	➔ 1NO+1NC	FR 631-W3	➔ 1NO+1NC	FR 651-W3	➔ 1NO+1NC
9	L	FR 915-W3	➔ 2NC	FR 930-W3	➔ 2NC	FR 931-W3	➔ 2NC	FR 951-W3	➔ 2NC
10	L	FR 1015-W3	2NO	FR 1030-W3	2NO	FR 1031-W3	2NO	FR 1051-W3	2NO
20	L	FR 2015-W3	➔ 1NO+2NC	FR 2030-W3	➔ 1NO+2NC	FR 2031-W3	➔ 1NO+2NC	FR 2051-W3	➔ 1NO+2NC
21	L	FR 2115-W3	➔ 3NC	FR 2130-W3	➔ 3NC	FR 2131-W3	➔ 3NC	FR 2151-W3	➔ 3NC
22	L	FR 2215-W3	➔ 2NO+1NC	FR 2230-W3	➔ 2NO+1NC	FR 2231-W3	➔ 2NO+1NC	FR 2251-W3	➔ 2NO+1NC
2	R	FR 215-W3	2NO+2NC	FR 230-W3	2NO+2NC	FR 231-W3	2NO+2NC	FR 251-W3	2NO+2NC
Max speed		page 6/5 - type 2		page 6/5 - type 1		page 6/5 - type 1		page 6/5 - type 1	
Min. force		8 N (25 N ➔)		0,06 Nm (0,25 Nm ➔)		0,06 Nm (0,25 Nm ➔)		0,06 Nm (0,25 Nm ➔)	
Travel diagrams		page 6/7 - group 1		page 6/7 - group 4		page 6/7 - group 4		page 6/7 - group 4	

Other rollers available. See page 2/52

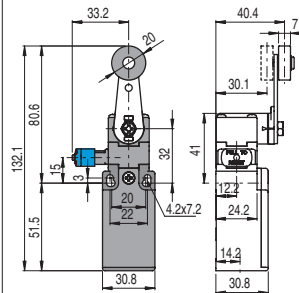

Other rollers available. See page 2/52

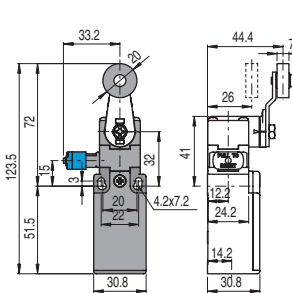

Other rollers available. See page 2/52

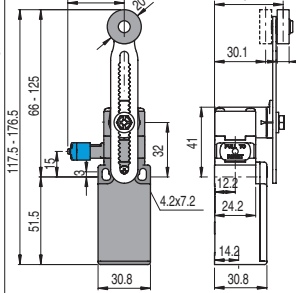

Other rollers available. See page 2/52

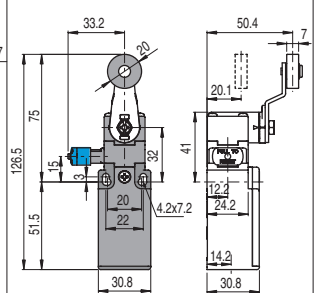

6	L	FR 652-W3	➔ 1NO+1NC	FR 654-W3	➔ 1NO+1NC	FR 656-W3	➔ 1NO+1NC	FR 657-W3	➔ 1NO+1NC
9	L	FR 952-W3	➔ 2NC	FR 954-W3	➔ 2NC	FR 956-W3	➔ 2NC	FR 957-W3	➔ 2NC
10	L	FR 1052-W3	2NO	FR 1054-W3	2NO	FR 1056-W3	2NO	FR 1057-W3	2NO
20	L	FR 2052-W3	➔ 1NO+2NC	FR 2054-W3	➔ 1NO+2NC	FR 2056-W3	➔ 1NO+2NC	FR 2057-W3	➔ 1NO+2NC
21	L	FR 2152-W3	➔ 3NC	FR 2154-W3	➔ 3NC	FR 2156-W3	➔ 3NC	FR 2157-W3	➔ 3NC
22	L	FR 2252-W3	➔ 2NO+1NC	FR 2254-W3	➔ 2NO+1NC	FR 2256-W3	➔ 2NO+1NC	FR 2257-W3	➔ 2NO+1NC
2	R	FR 252-W3	2NO+2NC	FR 254-W3	2NO+2NC	FR 256-W3	2NO+2NC	FR 257-W3	2NO+2NC
Max speed		page 6/5 - type 1		page 6/5 - type 1		page 6/5 - type 1		page 6/5 - type 1	
Min. force		0,06 Nm (0,25 Nm ➔)		0,06 Nm (0,25 Nm ➔)		0,06 Nm (0,25 Nm ➔)		0,06 Nm (0,25 Nm ➔)	
Travel diagrams		page 6/7 - group 4		page 6/7 - group 4		page 6/7 - group 4		page 6/7 - group 4	

Items with code on the green background are available in stock

Position switches with revolving lever without actuator

Contacts type:

- R** = snap action
- L** = slow action
- LO** = slow action overlapped
- LS** = slow action shifted
- LV** = slow action shifted and spaced
- LI** = slow action independent
- LA** = slow action closer
- ⏏** = electronic PNP

Contact blocks

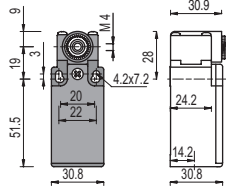

with manual reset knob

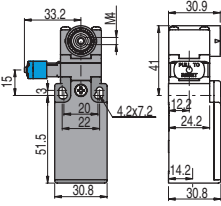

IMPORTANT

For safety applications: join only switches and actuators marked with symbol ⊕.
For more information about safety applications see page 6/1.

5	R	FR 538 ⊕	1NO+1NC	
6	L	FR 638 ⊕	1NO+1NC	FR 638-W3 ⊕ 1NO+1NC
7	LO	FR 738 ⊕	1NO+1NC	
9	L	FR 938 ⊕	2NC	FR 938-W3 ⊕ 2NC
10	L	FR 1038	2NO	FR 1038-W3 2NO
11	R	FR 1138 ⊕	2NC	
12	R	FR 1238	2NO	
13	LV	FR 1338 ⊕	2NC	
14	LS	FR 1438 ⊕	2NC	
15	LS	FR 1538	2NO	
16	LI	FR 1638 ⊕	2NC	
18	LA	FR 1838 ⊕	1NO+1NC	
20	L	FR 2038 ⊕	1NO+2NC	FR 2038-W3 ⊕ 1NO+2NC
21	L	FR 2138 ⊕	3NC	FR 2138-W3 ⊕ 3NC
22	L	FR 2238 ⊕	2NO+1NC	FR 2238-W3 ⊕ 2NO+1NC
2	R	FR 238	2x(1NO-1NC)	FR 238-W3 2NO+2NC
E1	⏏	FR E138	1NO-1NC	
Min. force		0,06 Nm (0,25 Nm ⊕)		0,06 Nm (0,25 Nm ⊕)
Travel diagrams		page 6/6 - group 5		page 6/7 - group 4

Loose actuators

10 pcs pack

IMPORTANT: These loose actuators can be used with items of series FR, FM, FX, FZ, FK only

Ø 18 mm roller	Ø 18 mm roller	Adjustable square rod 3x3x125 mm	Flexible rod actuator	Adjustable round rod Ø 3x125 mm	Polymer roller Ø 20 mm	
VF LE30 ⊕	VF LE31 ⊕	VF LE33	VF LE34	VF LE50	VF LE51 ⊕	
Polymer roller Ø 20 mm	Porcelain roller	Polymer roller Ø 20 mm	Adjustable actuator with polymer roller	Adjustable safety actuator with polymer roller	Polymer roller Ø 20 mm	Adjustable fiber glass rod
VF LE52 ⊕	VF LE53 ⊕ (2)	VF LE54 ⊕	VF LE55 ⊕ (1)	VF LE56 ⊕	VF LE57 ⊕	VF LE69

- Only orders for multiple quantities of the packs are accepted.

(1) Actuator VF LE55 suits to safety applications only if adjusted to its max length, as you can see in figure beside. If you need an adjustable lever for safety applications, use the adjustable safety lever VF LE56.

(2) The position switch obtained by assembling the switch FR •38 (e.g. FR 538, FR 638) with the actuator VF LE53 will not present the same travel diagrams and actuating forces as the position switch FR •53-E0V9 (e.g. FR 553-E0V9, FR 653-E0V9...).

(4) The actuator cannot be oriented to inside direction because it will mechanically interfere with the switch head.

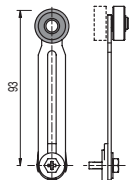

Accessories See page 5/1



Special loose actuators

10 pcs pack

IMPORTANT: These loose actuators can be used with items of series FR, FM, FX, FZ, FK only

Ø 20 mm stainless steel rollers

VF LE31-1 (1)	VF LE51-1 (1)	VF LE52-1 (1)	VF LE54-1 (1)	VF LE55-1 (1) (1)	VF LE56-1 (1)	VF LE57-1 (1)

Ø 35 mm polymer rollers

VF LE31-2 (4)	VF LE51-2 (4)	VF LE52-2 (4)	VF LE54-2 (4)	VF LE55-2 (1) (1)	VF LE56-2 (4)	VF LE57-2 (4)

Ø 40 mm rubber rollers

VF LE31-R5 (4)	VF LE51-R5 (4)	VF LE52-R5 (4)	VF LE54-R5 (4)	VF LE55-R5 (1) (1)	VF LE56-R5 (4)	VF LE57-R5 (4)

Ø 50 mm rubber rollers

VF LE51-3 (4)	VF LE52-3 (4)	VF LE54-3 (4)	VF LE55-3 (1) (1)	VF LE56-3 (4)	VF LE57-3 (4)

Ø 50 mm overhanging rubber rollers

VF LE55-4 (1) (1)	VF LE56-4 (1) (1)

Items with code on the green background are available in stock

X-ON Electronics

Largest Supplier of Electrical and Electronic Components

Click to view similar products for [Limit Switches](#) category:

Click to view products by [Pizzato](#) manufacturer:

Other Similar products are found below :

[6LS2-4PG](#) [5ML1-E1](#) [5ML31](#) [LZG1](#) [LZL1-6C](#) [622EN114-R](#) [622EN18-6](#) [622EN224-6B](#) [622EN230](#) [622EN237-R](#) [622EN69-3](#) [622EN85-RB](#)
[MA-10019](#) [6PA109](#) [7LS51](#) [83547001](#) [83725002](#) [83830001](#) [83840001](#) [83840701](#) [83841001](#) [83870104](#) [83881140](#) [8AS42](#) [8LS10](#) [8LS125-](#)
[4PG](#) [8LS152-4PGN20](#) [914CE16-3A](#) [914CE3-3L1](#) [915PA10](#) [91MCE16-P2O](#) [924CE16-Y3](#) [924CE1-S6](#) [924CE1-T25A](#) [924CE1-T3](#) [924CE1-](#)
[T9A](#) [924CE2-T9](#) [924CE31-Y20-X5](#) [924CE31-Y3L1](#) [GL-10054](#) [GL-85710](#) [GL-85714](#) [GLAB26J2B](#) [GLDB03C-6](#) [GLZ324](#) [PS21R-](#)
[NT11N7-YK0](#) [D4A-1106N](#) [D4A1201N](#) [D4A-3E02N](#) [D4A-4510N](#)