

## DESCRIPTION

MP156 is a primary-side regulator that provides accurate constant voltage (CV) regulation without opto-coupler, support Buck, Buck-Boost, Boost and Flyback topologies. It has an integrated 500V MOSFET to simplify the structure and reduce costs. These features make it a competitive candidate for off-line low power applications, such as home appliances and standby power.

MP156 is a green-mode-operation regulator. Both its the peak current and the switching frequency decrease as the load decreases to provide excellent efficiency at light load, thus improving the overall average efficiency.

MP156 features various protections, including thermal shutdown (TSD), VCC under-voltage lockout (UVLO), overload protection (OLP), short-circuit protection (SCP), and open loop protection.

MP156 is available in the TSOT23-5 and SOIC8 packages.

## FEATURES

- Primary-side constant voltage (CV) control, supporting Buck, Buck-Boost, Boost and Flyback topologies
- Integrated 500V/20Ω MOSFET
- <30mW no-load power consumption
- Up to 4W output power
- Maximum DCM output current less than 130mA
- Maximum CCM output current less than 220mA
- Low VCC Operating Current
- Frequency foldback
- Limited maximum frequency
- Peak-current compression
- Internal high-voltage current source
- Internal 350ns leading-edge blanking
- Thermal shutdown (auto restart)
- VCC under voltage lockout with hysteresis
- Timer based over-load protection.
- Short-circuit protection
- Open-loop protection

## APPLICATIONS

- Home appliances, white goods and consumer electronics
- Industrial controls
- Standby power

All MPS parts are lead-free and adhere to the RoHS directive. For MPS green status, please visit MPS website under Quality Assurance. "MPS" and "The Future of Analog IC Technology" are Registered Trademarks of Monolithic Power Systems, Inc.

## TYPICAL APPLICATION

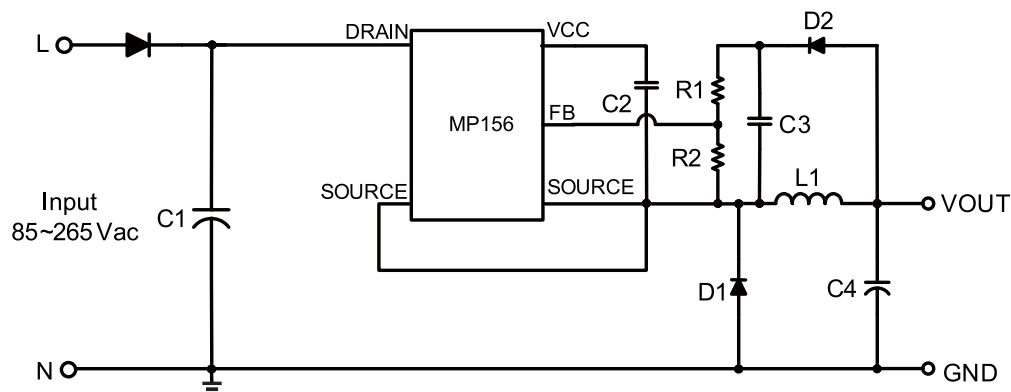

### ORDERING INFORMATION

| Part Number* | Package  | Top Marking |
|--------------|----------|-------------|
| MP156GJ      | TSOT23-5 | AFA         |
| MP156GS      | SOIC8    | MP156       |

\* For Tape & Reel, add suffix –Z (e.g. MP156GJ–Z);  
 \* For Tape & Reel, add suffix –Z (e.g. MP156GS–Z);

### PACKAGE REFERENCE

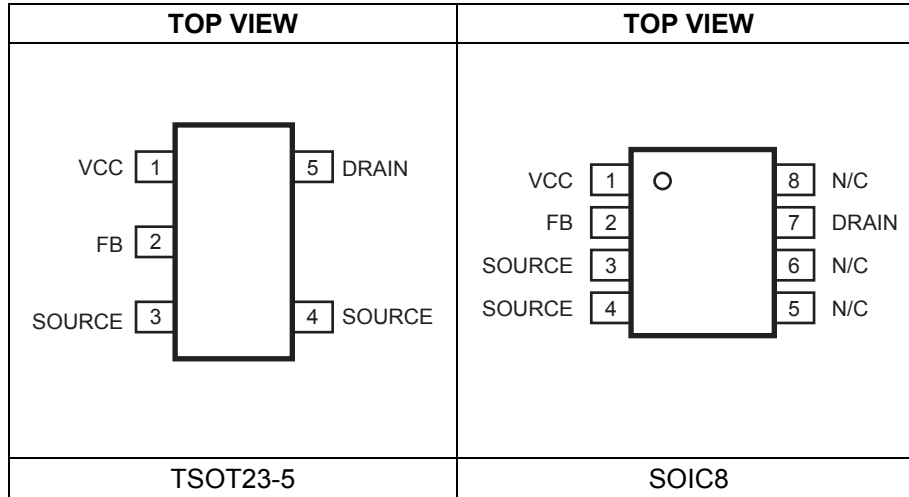

#### ABSOLUTE MAXIMUM RATINGS <sup>(1)</sup>

|   |                 |
|---|-----------------|
| Drain to source .....   | -0.7V to 500V   |
| All other pins .....  | -0.7V to 6.5V   |
| Continuous Power Dissipation .... (T <sub>A</sub> = +25°C) <sup>(2)</sup> |                 |
| TSOT23-5 .....  | 1W              |
| SOIC8 .....   | 1W              |
| Junction Temperature .....  | 150°C           |
| Lead Temperature .....  | 260°C           |
| Storage Temperature .....   | -60°C to +150°C |
| ESD Capability Human Body Mode .....                                      | 4.0kV           |
| ESD Capability Machine Mode .....   | 200V            |

#### Recommended Operating Conditions <sup>(3)</sup>

|  |                 |
|--|-----------------|
| Operating Junction Temp. (T <sub>J</sub> ) | -40°C to +125°C |
| Operating VCC range .....                  | 5.3V to 5.6V    |

#### Thermal Resistance <sup>(4)</sup>

|                | $\theta_{JA}$ | $\theta_{JC}$ |
|----------------|---------------|---------------|
| TSOT23-5 ..... | 100 .....     | 55... °C/W    |
| SOIC8 .....    | 96 .....      | 45... °C/W    |

#### Notes:

- Exceeding these ratings may damage the device.
- The maximum allowable power dissipation is a function of the maximum junction temperature T<sub>J</sub>(MAX), the junction-to-ambient thermal resistance  $\theta_{JA}$ , and the ambient temperature T<sub>A</sub>. The maximum allowance continuous power dissipation at any ambient temperature is calculated by PD(MAX)=(T<sub>J</sub>(MAX)-T<sub>A</sub>)/ $\theta_{JA}$ . Exceeding the maximum allowance power dissipation will cause excessive die temperature, and the regulator will go into thermal shutdown. Internal thermal shutdown circuit protects the device from permanent damage.
- The device is not guaranteed to function outside of its operating conditions.
- Measured on JESD51-7, 4-layer PCB.

## ELECTRICAL CHARACTERISTICS

$V_{CC} = 5.8V$ ,  $T_A = 25^{\circ}C$ , unless otherwise noted.

| Parameter  | Symbol          | Condition                       | Min  | Typ  | Max  | Units       |
|--|-----------------|---------------------------------|------|------|------|-------------|
| <b>Start-up Current Source (Drain Pin)</b>                   |                 |                                 |      |      |      |             |
| Internal regulator supply current                            | $I_{regulator}$ | $V_{CC}=4V; V_{Drain}=100V$     | 2.5  | 3.5  | 4.5  | mA          |
| Drain pin leakage current                                    | $I_{Leak}$      | $V_{CC}=5.8V; V_{Drain}=400V$   |      | 10   | 12   | $\mu A$     |
| Breakdown Voltage  | $V_{(BR)DSS}$   |                                 | 500  |      |      | V           |
| <b>Supply Voltage Management (VCC Pin)</b>                   |                 |                                 |      |      |      |             |
| VCC level (increasing) where the internal regulator stops    | $V_{CCOFF}$     |                                 | 5.4  | 5.6  | 5.8  | V           |
| VCC level (decreasing) where the internal regulator turns on | $V_{CCON}$      |                                 | 5.1  | 5.3  | 5.6  | V           |
| VCC regulator on and off hysteresis                          |                 |                                 |      | 250  |      | mV          |
| VCC level (decreasing) where the IC stops                    | $V_{CCstop}$    |                                 |      | 3.4  |      | V           |
| VCC level (decreasing) where the protection phase ends       | $V_{CCpro}$     |                                 |      | 2.4  |      | V           |
| Internal IC consumption                                      | $I_{CC}$        | $V_{CC}=5.8V, f_s=37kHz, D=40%$ |      |      | 430  | $\mu A$     |
| Internal IC consumption (No switching)                       | $I_{CC}$        |                                 |      |      | 165  | $\mu A$     |
| Internal IC consumption, latch-off phase                     | $I_{CCLATCH}$   | $V_{CC}=5.3V$                   |      | 16   |      | $\mu A$     |
| <b>Internal MOSFET (Drain Pin)</b>                           |                 |                                 |      |      |      |             |
| Breakdown Voltage  | $V_{BRDSS}$     |                                 | 500  |      |      | V           |
| ON resistance  | $R_{on}$        |                                 |      | 20   |      | $\Omega$    |
| <b>Internal Current Sense</b>                                |                 |                                 |      |      |      |             |
| Peak current limit   | $I_{Limit}$     |                                 | 260  | 290  | 345  | mA          |
| Leading-edge blanking  | $\tau_{LEB1}$   |                                 |      | 350  |      | ns          |
| SCP point  | $I_{SCP}$       |                                 |      | 450  |      | mA          |
| Leading-edge blanking for SCP                                | $\tau_{LEB2}$   |                                 |      | 180  |      | ns          |
| <b>Feedback Input (FB Pin)</b>                               |                 |                                 |      |      |      |             |
| Minimum off time   | $\tau_{minoff}$ |                                 | 15   | 18   | 21   | $\mu s$     |
| Primary MOSFET feedback turn-on threshold                    | $V_{FB}$        |                                 | 2.45 | 2.55 | 2.65 | V           |
| OLP feedback trigger threshold OLP                           | $V_{FB\_OLP}$   |                                 | 1.6  | 1.7  | 1.8  | V           |
| OLP delay time   | $\tau_{OLP}$    | $f_s=37kHz$                     |      | 170  |      | ms          |
| Open-loop detection  | $V_{OLD}$       |                                 |      | 60   |      | mV          |
| <b>Thermal Shutdown</b>                                      |                 |                                 |      |      |      |             |
| Thermal shutdown threshold                                   |                 |                                 |      | 150  |      | $^{\circ}C$ |

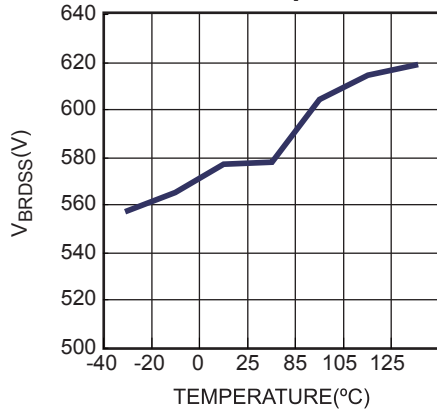
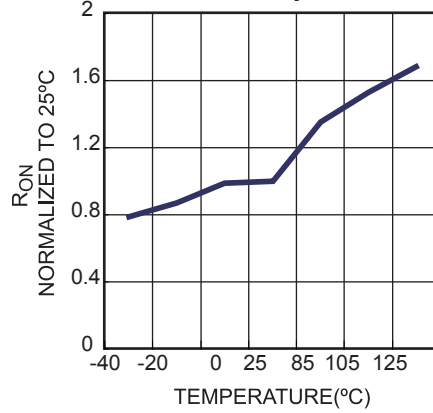
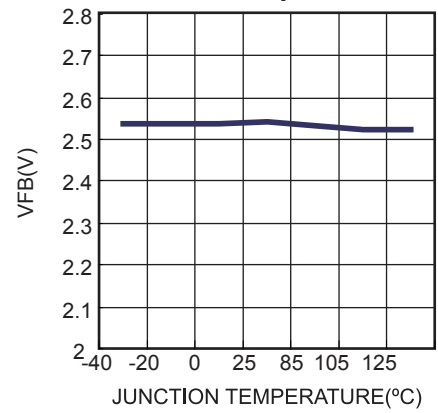
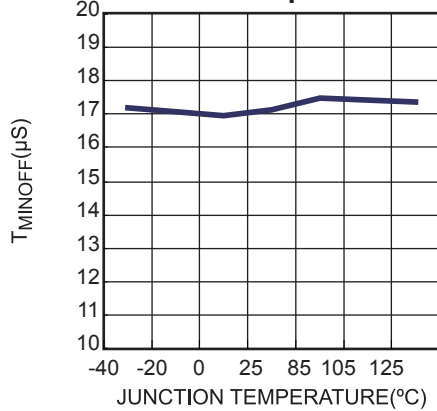
**TYPICAL CHARACTERISTICS**
**Breakdown Voltage vs. Junction Temperature**

**On-State Resistance vs. Junction Temperature**

**Feedback Voltage vs. Junction Temperature**

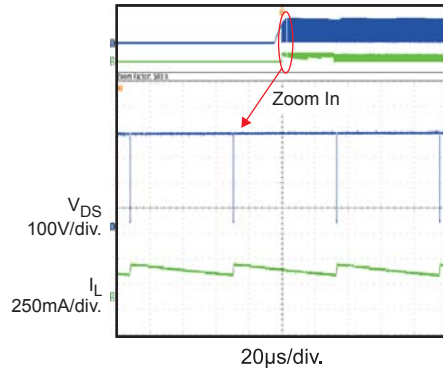
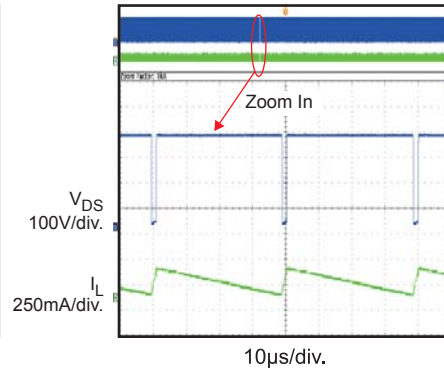
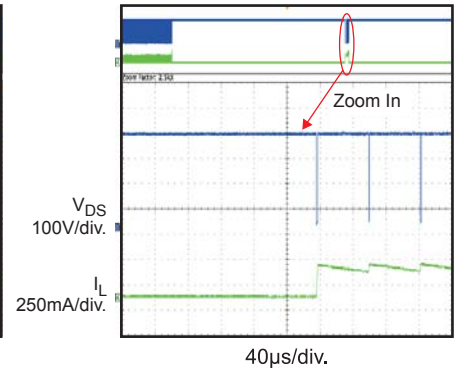
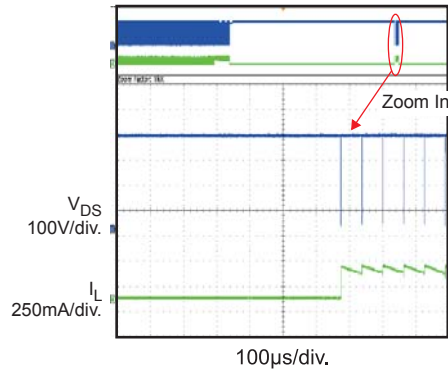
**Minimum Off Time vs. Junction Temperature**

**TYPICAL PERFORMANCE CHARACTERISTICS**

$V_{IN} = 265VAC$ ,  $V_{OUT} = 12V$ ,  $I_{OUT} = 150mA$ ,  $L = 1.8mH$ ,  $C_{OUT} = 100\mu F$ ,  $T_A = +25^{\circ}C$ , unless otherwise noted.

**Start Up**

**Normal Operation**

**SCP**

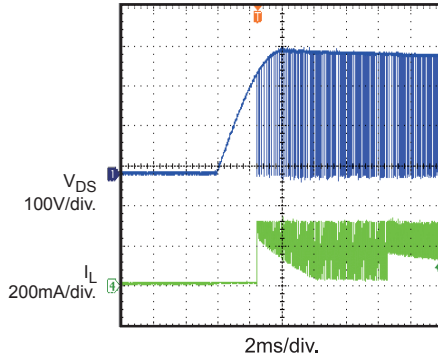
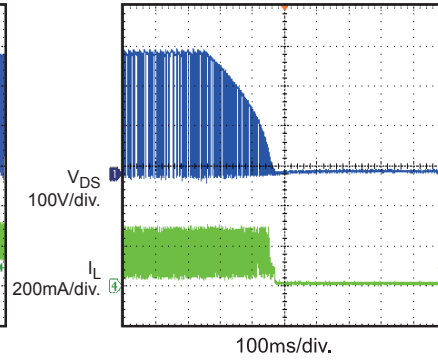
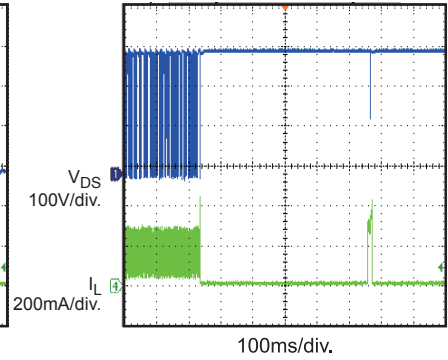
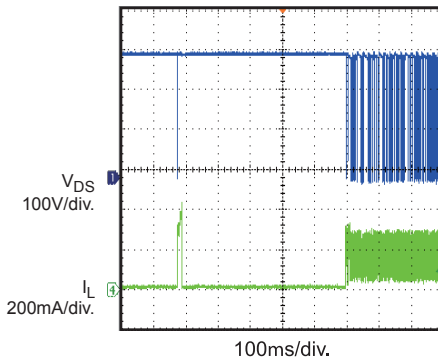
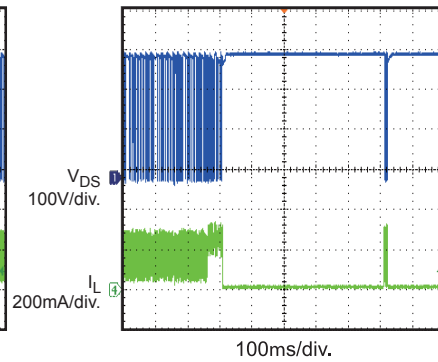
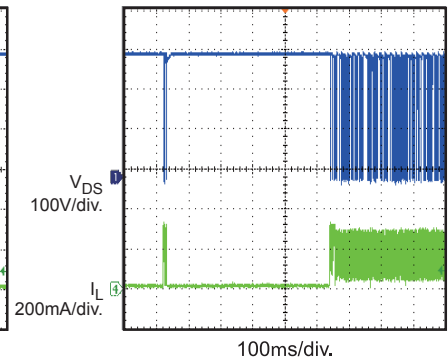
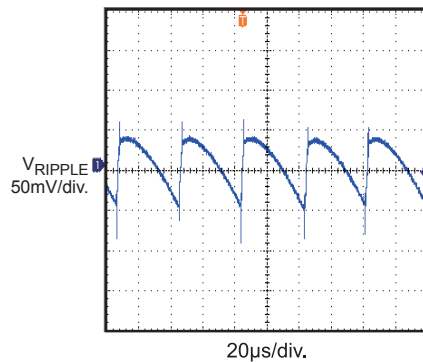
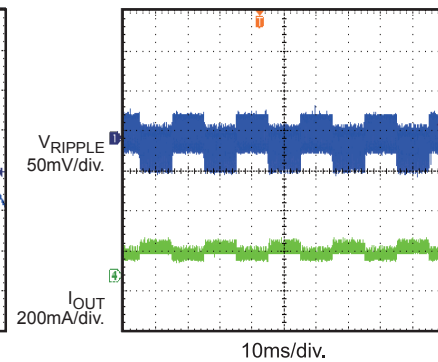
**Open Loop Protection**

**TYPICAL PERFORMANCE CHARACTERISTICS (continued)**

$V_{IN} = 230VAC$ ,  $V_{OUT} = 12V$ ,  $I_{OUT} = 150mA$ ,  $L = 1.8mH$ ,  $C_{OUT} = 100\mu F$ ,  $T_A = +25^\circ C$ , unless otherwise noted.

**Input Power Start Up**

**Input Power Shut Down**

**SCP Entry**

**SCP recovery**

**Open Loop Entry**

**Open Loop Recovery**

**Output Voltage Ripple**

**Load Transient**

**PIN FUNCTIONS**

| Pin #<br>TSOT23-5 | Pin #<br>SOIC8 | Name   | Description   |
|-------------------|----------------|--------|---|
| 1                 | 1              | VCC    | Control circuit power supply.                                       |
| 2                 | 2              | FB     | Regulator feedback.   |
| 3,4               | 3,4            | SOURCE | Internal power MOSFET source. Ground reference for VCC and FB pins. |
| 5                 | 7              | DRAIN  | Internal power MOSFET drain. High-voltage current source input.     |
|                   | 5,6,8          | N/C    | Not connected.  |

FUNCTIONAL BLOCK DIAGRAM

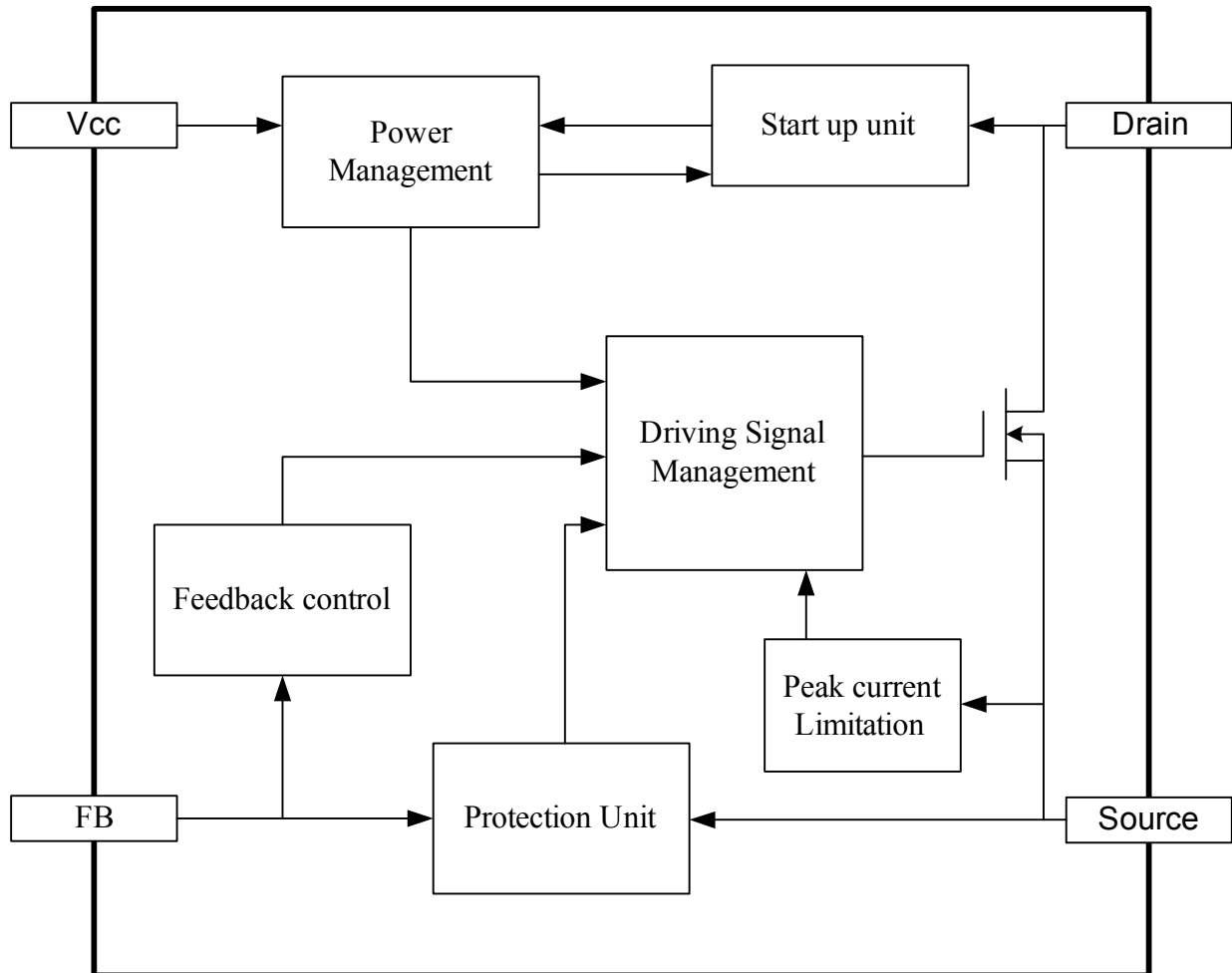

Figure 1: Functional Block Diagram



## OPERATION

MP156 is a green-mode-operation regulator: the peak current and the switching frequency both decrease with a decreasing load. As a result, it still offers excellent light-load efficiency, thus improved average efficiency. The typical application diagram shows the regulator operating with a minimum number of external components. It incorporates multiple features as described in the following sections.

### Start-Up and Under-Voltage Lockout

The internal high-voltage regulator self-supplies the IC from the Drain pin. The IC starts switching and the internal high voltage regulator turns off when the voltage on VCC reaches 5.6V. The internal high-voltage regulator turns on to charge the external VCC capacitor when the VCC voltage falls below 5.3V. A small capacitor (in the low  $\mu\text{F}$  range) can maintain the VCC voltage and thus lower the capacitor cost.

When the VCC voltage drops below 3.4V, the IC stops switching, then the internal high-voltage regulator charges the VCC capacitor.

Under fault conditions—such as OLP, SCP, and OTP—the IC stops switching and an internal current source ( $\sim 16\mu\text{A}$ ) discharges the VCC capacitor. The internal high-voltage regulator will not charge the VCC capacitor until the VCC voltage drops below 2.4V. Under fault conditions, estimate the restart time using the following equation,

$$\tau_{\text{restart}} = C_{\text{VCC}} \times \frac{V_{\text{CC}} - 2.4\text{V}}{16\mu\text{A}} + C_{\text{VCC}} \times \frac{5.6\text{V} - 2.4\text{V}}{3.5\text{mA}}$$

Figure 2 shows the typical waveform with VCC under-voltage lockout.

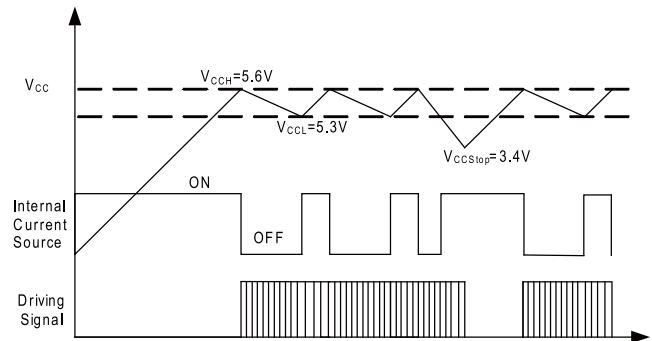
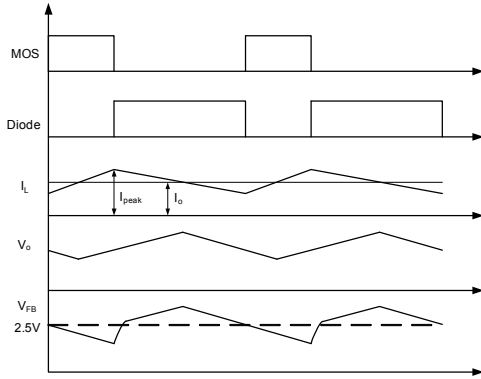

**Figure 2: VCC Under-Voltage Lockout**

### Constant Voltage Operation

MP156 acts as a fully-integrated regulator when used in the Buck topography, as shown in the typical application on page 1.

At the beginning of each cycle, the integrated MOSFET turns ON while the feedback voltage remains below the 2.5V reference voltage, which indicates insufficient output voltage. The peak current limitation determines the ON period. After the ON period elapses, the integrated MOSFET turns off. The freewheeling diode (D1) will not turn on until the inductor (L1) charges the sampling capacitor (C3) voltage to equal the output voltage. The sampling capacitor voltage changes with the output voltage, and can sample and hold the output voltage to regulate the output voltage. The sampling capacitor voltage will decrease when the L1 inductor current falls below the output current. When the feedback voltage falls below the 2.5V reference voltage, a new switching cycle begins. Figure 3 shows this operation under CCM in detail.

**Figure 3:  $V_{FB}$  vs.  $V_o$** 

Thus monitoring the sampling capacitor regulates the output voltage. Use the following equation to determine the output voltage:

$$V_o = 2.5V \times \frac{R1+R2}{R2}$$

### Frequency Foldback

Under light-load or no-load conditions, the output drops very slowly, thus increasing the time when the MOSFET turn-on time. The frequency decreases as the load decreases. The MP156 remains highly efficiency under light-load condition by reducing the switching frequency automatically.

Determine the switching frequency as:

$$f_s = \frac{(V_{in} - V_o)}{2L(I_{peak} - I_o)} \cdot \frac{V_o}{V_{in}}, \text{ for CCM}$$

$$f_s = \frac{2(V_{in} - V_o)}{LI_{peak}^2} \cdot \frac{I_o V_o}{V_{in}}, \text{ for DCM}$$

At the same time, the peak current limit decreases from 290mA as the off-time increases. In standby mode, the frequency and the peak current are both minimized, allowing for a smaller dummy load. As a result, peak-current compression helps to reduce no-load consumption. Estimate the peak current limit from the following equation ( $\tau_{off}$  is the power module's off time):

$$I_{Peak} = 290mA - (1mA / \mu s) \times (\tau_{off} - 18\mu s)$$

### Minimum Off-Time Limit

The MP156 implements a minimum off-time limit. During normal operation, the minimum off-time limit is 18 $\mu s$ , and this limit gradually shortens during the start-up period from 72 $\mu s$ , to 36 $\mu s$ , to 18 $\mu s$  (see Figure 4). Each minimum off-time retains 128 switching cycles. This soft-start function provides a safe start-up.

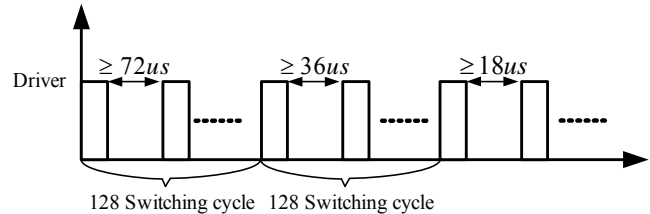
**Figure 4:  $\tau_{min\ off}$  at Start-Up**

### EA Compensation

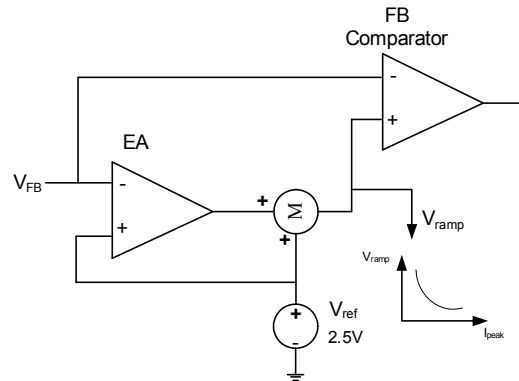
**Figure 5: EA and Ramp Compensation**

The MP156 features error amplifier (EA) compensation function (Shown in Figure 5) to improve load regulation. 6 $\mu s$  after the MOSFET turns off, the MP156 samples the feedback voltage. Thus EA compensation regulates the 2.5V reference voltage with the load to improve overall power regulation.

### Ramp Compensation

An internal ramp compensation circuit precisely maintains the output voltage. Figure 6 shows an exponential voltage sinking source added to pull down the reference voltage of the feedback comparator. The ramp compensation is a function of the load conditions: the compensation is about the 1mV/ $\mu s$  under full-load conditions compensation increases exponentially as the load decreases.

### Over-Load Protection (OLP)

The peak current and the switching frequency both increase as the load increases. When the switching frequency and peak current reach their maximums, the output voltage decreases if the load continues to increase so that the FB voltage drops below the OLP point.

The MP156 continuously monitors FB. When the FB voltage drops below 1.7V—which is considered as an error flag—the timer starts. Removing the error flag resets the timer. If the timer reaches 170ms ( $f_s=37\text{kHz}$ ), OLP occurs. This timer duration avoids triggering OLP when the power supply starts up or is in a load transition phase: The power supply should start up in less than 170ms ( $f_s=37\text{kHz}$ ). Changing the switching frequency changes the OLP delay time as per the following equation:

$$\tau_{\text{Delay}} \approx 170\text{ms} \times \frac{37\text{kHz}}{f_s}$$

### Short-Circuit Protection (SCP)

The MP156 monitors the peak current, and shuts down when the peak current rises above 450mA through short-circuit protection. The power supply resumes operation with the removal of the fault.

### Thermal Shutdown (TSD)

To prevent any lethal thermal damage, the MP156 shuts down switching when the inner temperature exceeds 150°C. During the thermal shutdown (TSD), the VCC capacitor discharges to 2.4V, and then the internal high voltage regulator re-charges by.

### Open-Loop Detection

If  $V_{\text{FB}}$  is less than 60mV, the IC will stop switching and a re-start cycle will begin. During start-up, the open loop detection is blanked for 128 switching cycles.

### Leading-Edge Blanking

An internal leading-edge blanking (LEB) unit—between the current sense resistor inside the IC and the current comparator input—avoids premature switching pulse termination due to parasitic capacitance,. During the blanking time, the current comparator is disabled and can not turn off the external MOSFET. Figure 6 shows the leading-edge blanking.

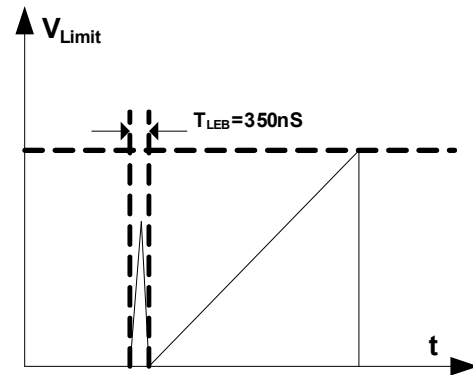

**Figure 6: Leading-Edge Blanking**

**APPLICATION INFORMATION**
**Table 1. Common Topologies Using MP156**

| Topology                    | Circuit Schematic | Features  |
|-----------------------------|-------------------|---|
| <b>High-Side Buck</b>       |                   | <ol style="list-style-type: none"> <li>1. <b>No-isolation,</b></li> <li>2. <b>Positive output</b></li> <li>3. <b>Low cost</b></li> <li>4. <b>Direct feedback</b></li> </ol> |
| <b>High-Side Buck-Boost</b> |                   | <ol style="list-style-type: none"> <li>1. <b>No-isolation,</b></li> <li>2. <b>Negative output</b></li> <li>3. <b>Low cost</b></li> <li>4. <b>Direct feedback</b></li> </ol> |
| <b>Boost</b>                |                   | <ol style="list-style-type: none"> <li>1. <b>No-isolation,</b></li> <li>2. <b>Positive output</b></li> <li>3. <b>Low cost</b></li> <li>4. <b>Direct feedback</b></li> </ol> |
| <b>Flyback</b>              |                   | <ol style="list-style-type: none"> <li>1. <b>Isolation,</b></li> <li>2. <b>Positive output</b></li> <li>3. <b>Low cost</b></li> <li>4. <b>Indirect feedback</b></li> </ol>  |

## Topology Options

MP156 can be used in common topologies, such as Buck, Buck-Boost, Boost and Flyback. Please find the Table.1 for more information.

## Component Selection

### Input Capacitor

The input capacitor supplies the DC input voltage for the converter. Figure 7 shows the typical DC bus voltage waveform of a half-wave rectifier.

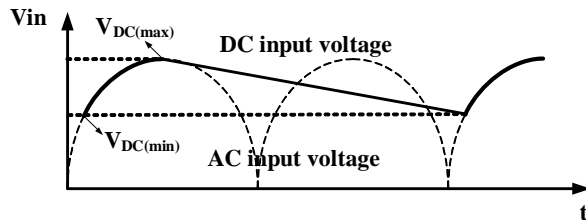

**Figure 7: Input Voltage Waveform**

Typically, the use of a half-wave rectifier requires an input capacitor rated at 3uF/W for the universal input condition. When using the full-wave rectifier, choose a smaller capacitor. Avoid a minimum DC voltage below 70V; a low DC input voltage can cause thermal shutdown.

### Inductor

The MP156 has a minimum off-time limit that determines the maximum power output. The maximum power increases as the inductor increases. Using a smaller inductor may cause failure at full load, but a larger inductor means a higher OLP load. For best results, select an inductor with the minimum value that can supply the rated power. Estimate the maximum power with:

$$P_{o\max} = V_o \left( I_{\text{peak}} - \frac{V_o \tau_{\text{minoff}}}{2L} \right), \text{ for CCM}$$

$$P_{o\max} = \frac{1}{2} L I_{\text{peak}}^2 \cdot \frac{1}{\tau_{\text{minoff}}}, \text{ for DCM}$$

To account for different converter tolerances—such as peak current limitation, minimum off time and so on—find the minimum value,  $P_{\min}$ , of the maximum output power. Choose an inductor with a  $P_{\min}$  higher than the rated power.

Figure 8 shows a example of a  $P_{\min}$  curve with a 12V output. ( $I_{\text{peak}}=0.29\text{A}$ ,  $\tau_{\text{minoff}}=18\mu\text{s}$ )

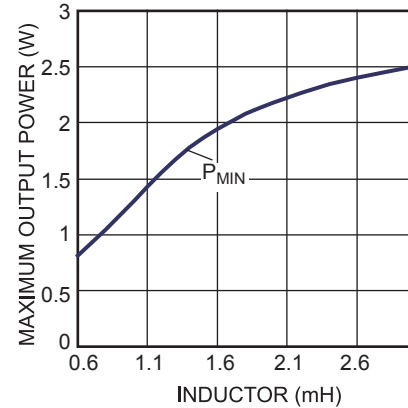

**Figure 8:  $P_{\min}$  vs. L at 12V**

For a 1.2W converter (12V, 0.1A), the minimum inductor value is about 0.9mH.

To reduce costs, use a standard off-the-shelf inductor no less than the calculated value.

### Freewheeling Diode

Select a diode with a maximum reverse voltage rating greater than the maximum input voltage, and a current rating determined by the output current.

The freewheeling diode's reverse recovery can affect efficiency and circuit operation, so use an ultra fast diode such as the EGC10JH.

### Output Capacitor

The output capacitor is required to maintain the DC output voltage. Estimate the output voltage ripple as:

$$V_{\text{CCM\_ripple}} = \frac{\Delta i}{8f_s C_o} + \Delta i \cdot R_{\text{ESR}}, \text{ for CCM}$$

$$V_{\text{DCM\_ripple}} = \frac{I_o}{f_s C_o} \cdot \left( \frac{I_{\text{pk}} - I_o}{I_{\text{pk}}} \right)^2 + I_{\text{pk}} \cdot R_{\text{ESR}}, \text{ for DCM}$$

For best results, use ceramic, tantalum or low ESR electrolytic capacitors to reduce the output voltage ripple.

### Feedback Resistors

The resistor divider determines the output voltage. Choose appropriate values for R1 and R2 to maintain  $V_{FB}$  at 2.5V. Avoid large R2 value (typically 5kΩ to 10kΩ).

### Feedback Capacitor

The feedback capacitor provides a sample and hold function. Small capacitors result in poor regulation at light loads, and large capacitors affect the circuit operation. Roughly estimate an optimal capacitor value using the following equation:

$$\frac{1}{2} \frac{V_o}{R_1 + R_2} \cdot \frac{C_o}{I_o} \leq C_{FB} \leq \frac{V_o}{R_1 + R_2} \cdot \frac{C_o}{I_o}$$

Choose the nearest appropriate value.

### Dummy Load

A dummy load is required to maintain the load regulation. This ensures sufficient inductor energy to charge the sample and hold capacitor to detect the output voltage. Normally a 3mA dummy load is needed and can be adjusted to the regulated voltage. Increasing the dummy load reduces the efficiency and no-load consumption. Use a zener diode if no-load regulation is not a concern.

### Auxiliary VCC Supply

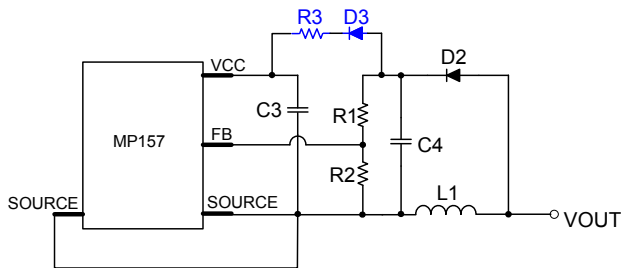

**Figure 9: Auxiliary V<sub>CC</sub> Supply Circuit**

The MP156 drops below the 30mW no-load power requirement. This chip requires a diode (D3) to reduce overall power consumption.

In addition, the MP156 requires an external VCC supply. This supply is derived from the resistor connected between C3 and C4. For values

above  $V_o=7V$ , determine R3 as per the formula below.

$$R \approx \frac{V_o - 5.8V}{180\mu A}$$

### Surge Performance

Select an appropriate input capacitor value to obtain a good surge performance. Figure 10 shows the half-wave rectifier. Table 2 shows the capacitance required under normal condition for different surge voltages.

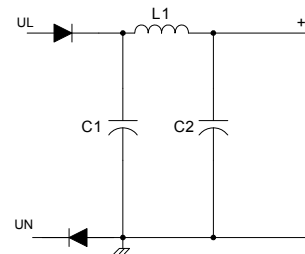

**Figure 10: Half-Wave Rectifier**

**Table 2: Recommended Capacitance**

| Surge voltage | 500V | 1000V | 2000V |
|---------------|------|-------|-------|
| <b>C1</b>     | 1μF  | 10μF  | 22μF  |
| <b>C2</b>     | 1μF  | 4.7μF | 10μF  |

### Layout Guide

PCB layout is very important for reliable operation, and good EMI and thermal performance. Please follow these guidelines to optimize performance.

- 1) Minimize the loop area formed by the input capacitor, IC, freewheeling diode, inductor and output capacitor.
- 2) Place the power inductor far away from the input filter.
- 3) Place a capacitor valued at several hundred pF between the FB pin and source as close the IC as possible.
- 4) Connect the exposed pad with the DRAIN pin to a larger copper area to improve thermal performance.

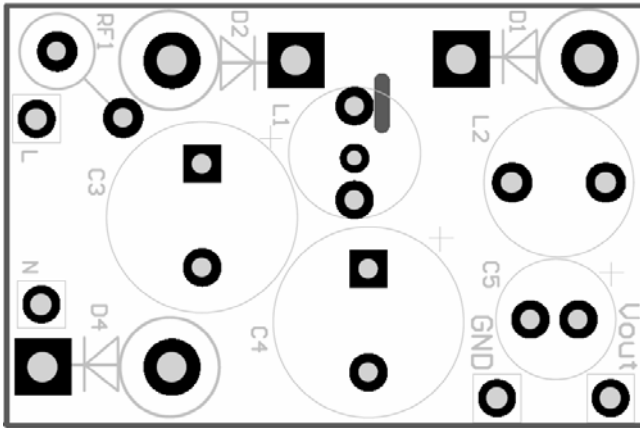
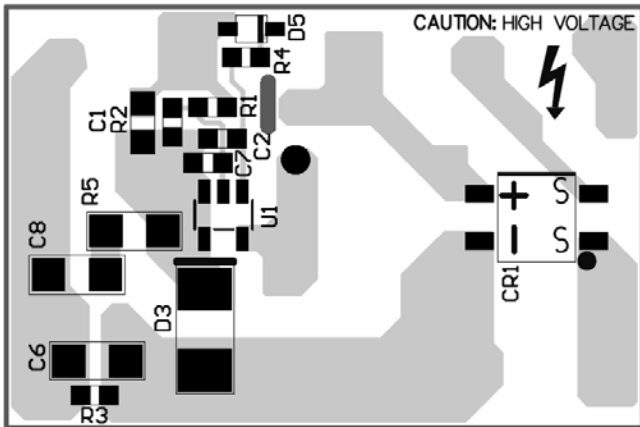
**Top**

**Bottom Layer**

### Design Example

Below is a design example following the application guidelines for the specifications:

**Table 3: Design Example**

|           |                 |
|-----------|-----------------|
| $V_{IN}$  | 85VAC to 265VAC |
| $V_{OUT}$ | 12V             |
| $I_{OUT}$ | 150mA           |

The detailed application schematic is shown in Figure. The typical performance and circuit waveforms have been shown in the Typical Performance Characteristics section. For more device application, please refer to the related Evaluation Board Datasheets.

TYPICAL APPLICATION CIRCUITS

Figure 11 shows a typical application example of a 12V, 150mA non-isolated power supply using MP156.

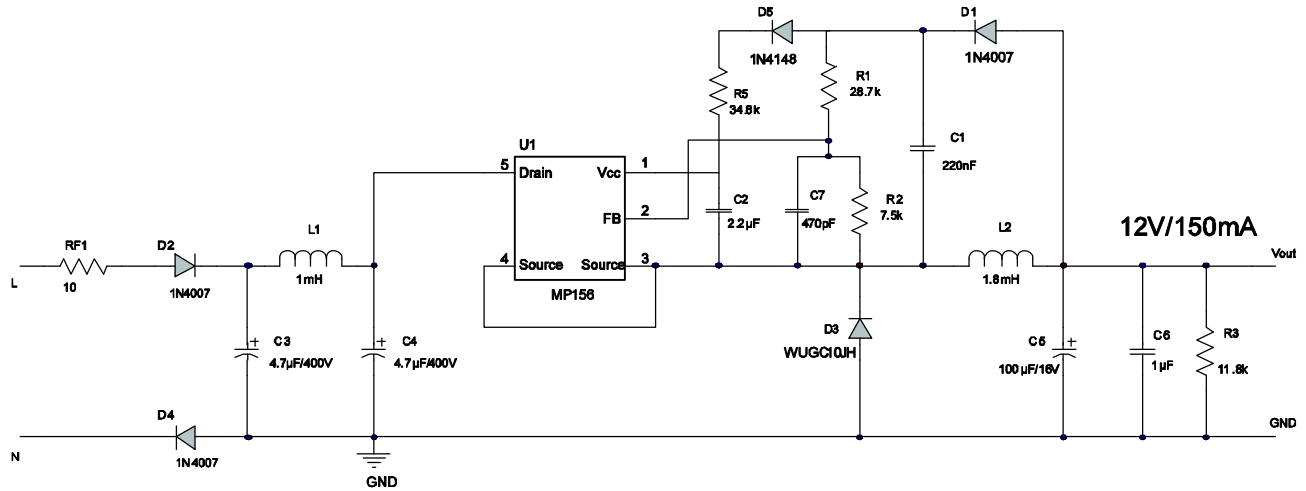
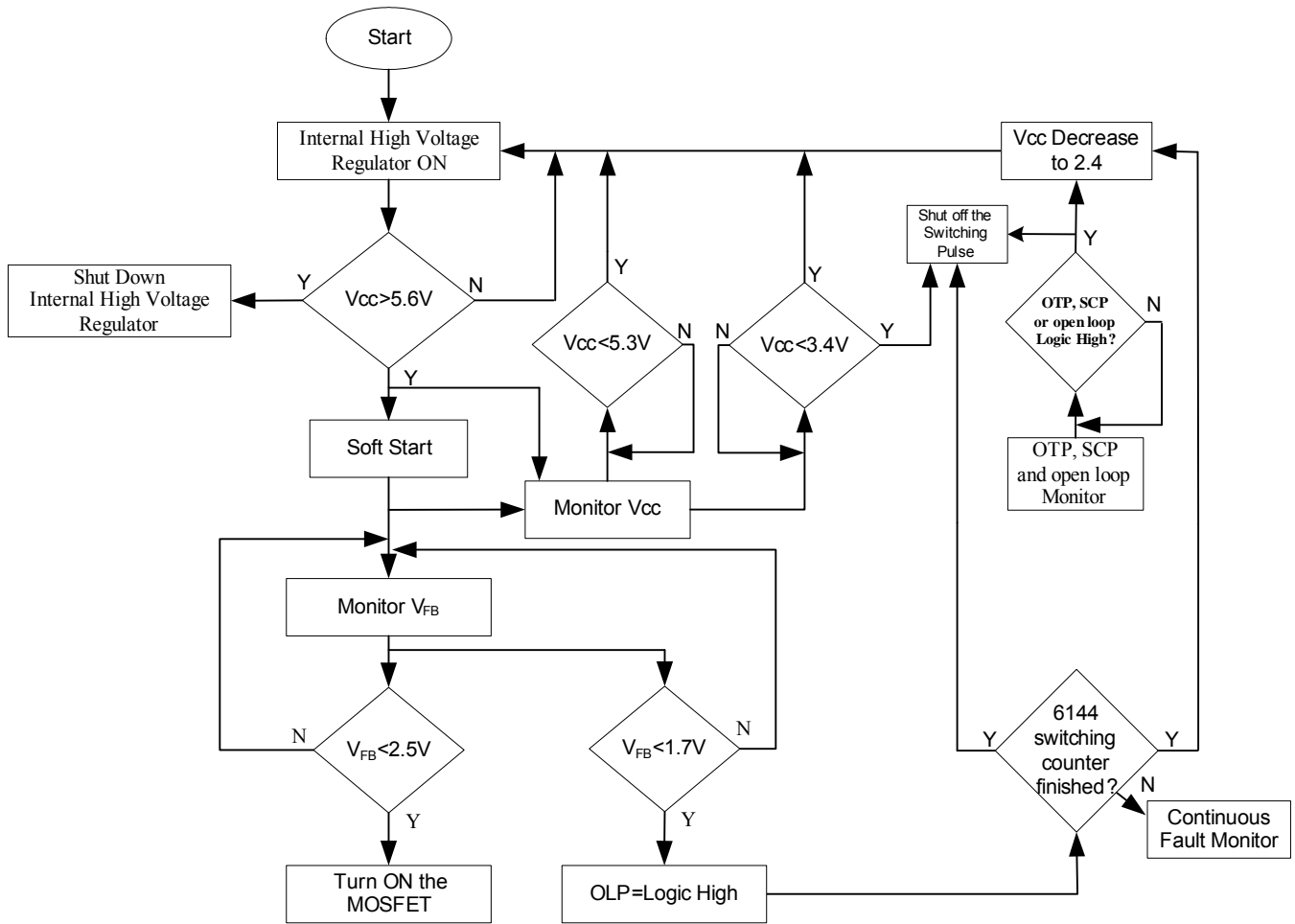

Figure 11: Typical Application at 12V, 150mA



FLOW CHART



UVLO, OTP, SCP, OLP and Open Loop Protection are auto restart

Figure 12: Control Flow Chart

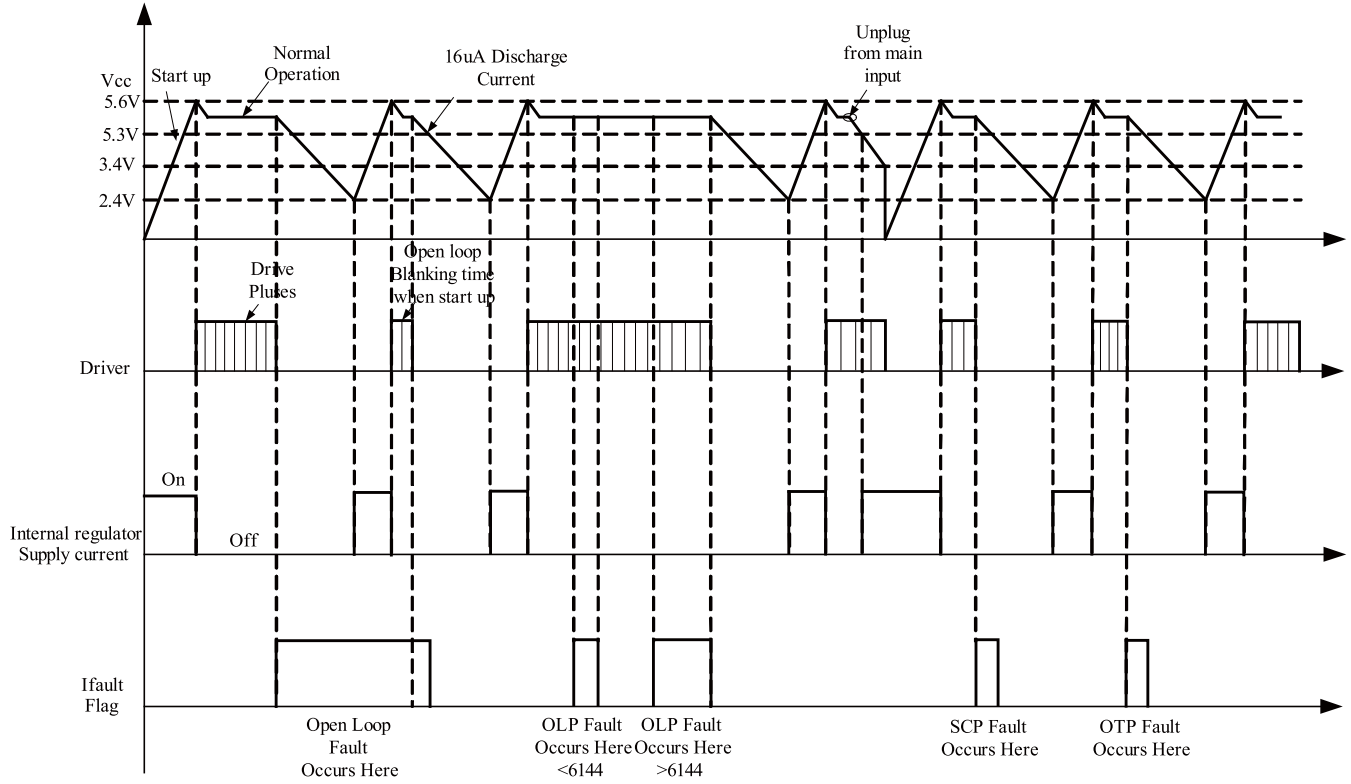
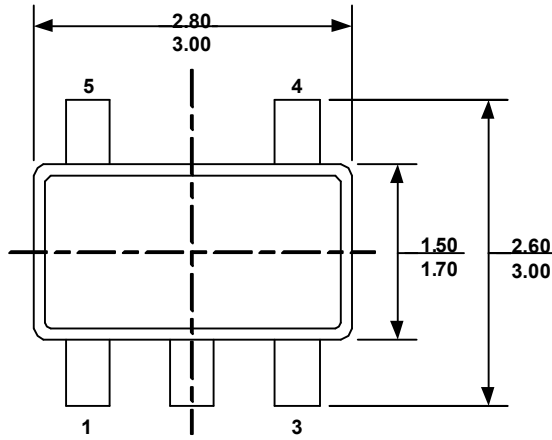

Figure 13: Signal Evolution in the Presence of a Fault

## PACKAGE INFORMATION

## TSOT23-5



TOP VIEW

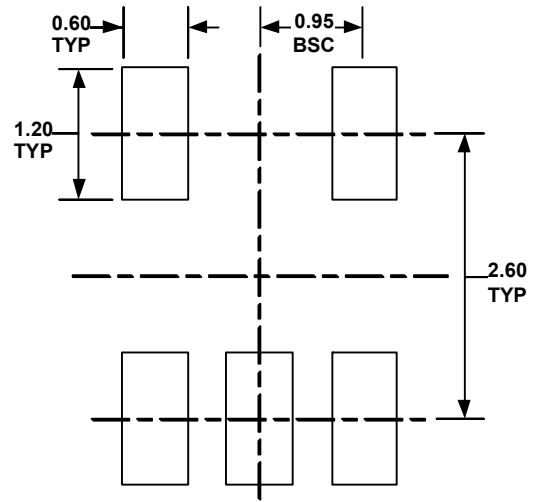

RECOMMENDED LAND PATTERN

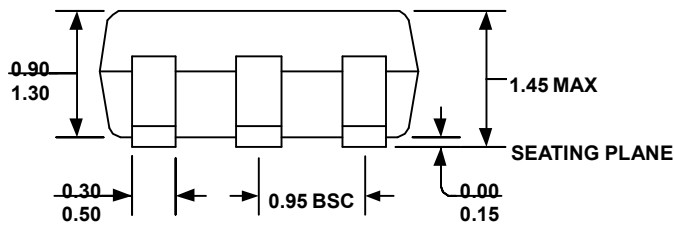

FRONT VIEW

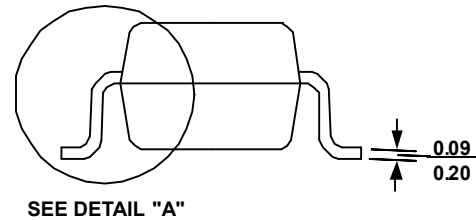

SIDE VIEW

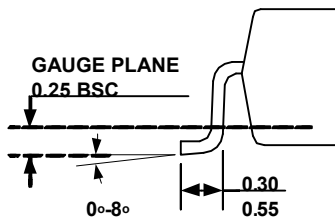

DETAIL "A"

## NOTE:

- 1) ALL DIMENSIONS ARE IN MILLIMETERS
- 2) PACKAGE LENGTH DOES NOT INCLUDE MOLD FLASH, PROTRUSION OR GATE BURR
- 3) PACKAGE WIDTH DOES NOT INCLUDE INTERLEAD FLASH OR PROTRUSION
- 4) LEAD COPLANARITY (BOTTOM OF LEADS AFTER FORMING) SHALL BE 10 MILLIMETERS MAX.
- 5) DRAWING CONFORMS TO JEDEC MO-178, VARIATION AA.
- 6) DRAWING IS NOT TO SCALE.

PACKAGE INFORMATION

SOIC8

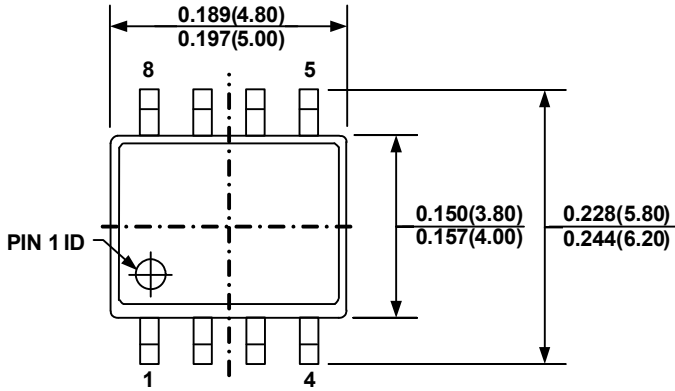

TOP VIEW

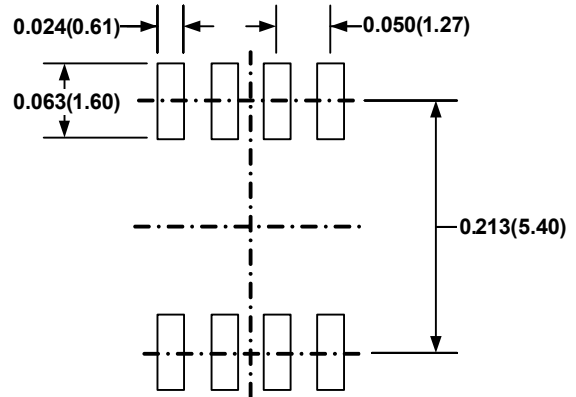

RECOMMENDED LAND PATTERN

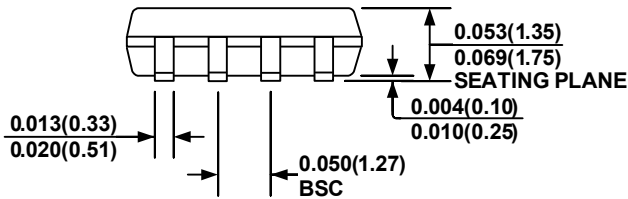

FRONT VIEW

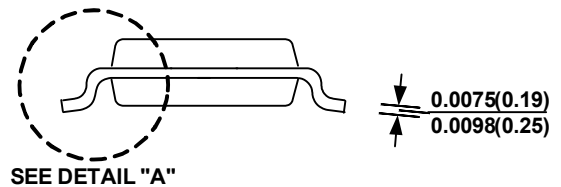

SIDE VIEW

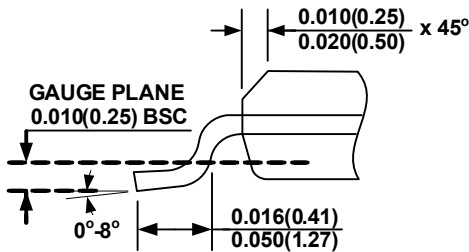

DETAIL "A"

NOTE:

- 1) CONTROL DIMENSION IS IN INCHES DIMENSION IN BRACKET IS IN MILLIMETERS
- 2) PACKAGE LENGTH DOES NOT INCLUDE MOLD FLASH, PROTRUSIONS OR GATE BURRS
- 3) PACKAGE WIDTH DOES NOT INCLUDE INTERLEAD FLASH OR PROTRUSIONS.
- 4) LEAD COPLANARITY(BOTTOM OF LEADS AFTER FORMING) SHALL BE 0.004" INCHES MAX.
- 5) DRAWING CONFORMS TO JEDEC MS012, VARIATION AA
- 6) DRAWING IS NOT TO SCALE

**NOTICE:** The information in this document is subject to change without notice. Please contact MPS for current specifications. Users should warrant and guarantee that third party Intellectual Property rights are not infringed upon when integrating MPS products into any application. MPS will not assume any legal responsibility for any said applications.

## X-ON Electronics

Largest Supplier of Electrical and Electronic Components

*Click to view similar products for [AC/DC Converters](#) category:*

*Click to view products by [Monolithic Power Systems](#) manufacturer:*

Other Similar products are found below :

[FSFR2100US](#) [AP3776MTR-G1](#) [BP5037B15](#) [BP5722A12](#) [NCP1070STCT3G](#) [NCP1076STBT3G](#) [NCP1910B100DWR2G](#) [ICE3AR0680VJZ](#)  
[ICE3AR1080VJZ](#) [ICE3AR1580VJZ](#) [ICE3AR2280CJZ](#) [ICE3BR2280JZ](#) [ICE3RBR4765JZ](#) [SEA01](#) [FAN7621SSJX](#) [MP172GJ-Z](#) [MP174GJ-P](#)  
[BP5011](#) [BP5055-12](#) [BP5710-1](#) [BP5718A12](#) [ICE2QR4780Z](#) [ICE3AR4780VJZ](#) [NCP1077P130G](#) [NCP1077STBT3G](#) [VIPER0PLD](#)  
[FSL206MRLX](#) [NCP1060BD100R2G](#) [NCP1124BP100G](#) [AP3983EP7-G1](#) [TEA19363T/1J](#) [AP3171MPTR-G1](#) [ICE3B0365J](#) [NCP1070P100G](#)  
[AP3125CMKTR-G1](#) [NCP1076P100G](#) [MP174GS-Z](#) [MP171GJ-Z](#) [MP150GS](#) [SC1076P065G](#) [NCP1071STBT3G](#) [NCP1071P100G](#)  
[NCP1070P130G](#) [VI-RUR22-EWXX](#) [AME15-512TCJZ](#) [47132](#) [47165](#) [47220](#) [47223](#) [47224](#)