

Features

- AEC-Q100 device qualification and full PPAP support available in both I-grade and extended temperature Q-grade
- Guaranteed to meet full electrical specifications over $T_A = -40^{\circ}\text{C}$ to $+105^{\circ}\text{C}$ with T_J Maximum = $+125^{\circ}\text{C}$ (Q-grade)
- Optimized for 1.8V systems
- Industry's best 0.18 micron CMOS CPLD
 - Optimized architecture for effective logic synthesis
 - Multi-voltage I/O operation — 1.5V to 3.3V
- Available in the following package options
 - 100-pin VQFP with 80 user I/O
 - 132-ball CP (0.5 mm) BGA with 100 user I/O
 - Pb-free only for all packages
- Advanced system features
 - Fastest in system programming
 - 1.8V ISP using IEEE 1532 (JTAG) interface
 - IEEE1149.1 JTAG Boundary Scan Test
 - Optional Schmitt-trigger input (per pin)
 - Unsurpassed low power management
 - DataGATE enable (DGE) signal control
 - Two separate I/O banks
 - RealDigital 100% CMOS product term generation
 - Flexible clocking modes
 - Optional DualEDGE triggered registers
 - Clock divider (divide by 2,4,6,8,10,12,14,16)
 - CoolCLOCK
 - Global signal options with macrocell control
 - Multiple global clocks with phase selection per macrocell
 - Multiple global output enables
 - Global set/reset
 - Advanced design security
 - Open-drain output option for Wired-OR and LED drive
 - PLA architecture
 - Superior pinout retention
 - 100% product term routability across function block
 - Optional bus-hold, 3-state or weak pull-up on selected I/O pins
 - Optional configurable grounds on unused I/Os
 - Mixed I/O voltages compatible with 1.5V, 1.8V, 2.5V, and 3.3V logic levels
 - Hot pluggable

Refer to the CoolRunner™-II Automotive CPLD family data sheet for architecture description.

WARNING: Programming temperature range of $T_A = 0^{\circ}\text{C}$ to $+70^{\circ}\text{C}$.

Description

The CoolRunner-II Automotive 128-macrocell device is designed for both high performance and low power applications. This lends power savings to high-end communication equipment and high speed to battery operated devices. Due to the low power stand-by and dynamic operation, overall system reliability is improved.

This device consists of eight Function Blocks inter-connected by a low power Advanced Interconnect Matrix (AIM). The AIM feeds 40 true and complement inputs to each Function Block. The Function Blocks consist of a 40 by 56 P-term PLA and 16 macrocells which contain numerous configuration bits that allow for combinational or registered modes of operation.

Additionally, these registers can be globally reset or preset and configured as a D or T flip-flop or as a D latch. There are also multiple clock signals, both global and local product term types, configured on a per macrocell basis. Output pin configurations include slew rate limit, bus hold, pull-up, open drain and programmable grounds. A Schmitt-trigger input is available on a per input pin basis. In addition to storing macrocell output states, the macrocell registers may be configured as direct input registers to store signals directly from input pins.

Clocking is available on a global or Function Block basis. Three global clocks are available for all Function Blocks as a synchronous clock source. Macrocell registers can be individually configured to power up to the zero or one state. A global set/reset control line is also available to asynchronously set or reset selected registers during operation. Additional local clock, synchronous clock-enable, asynchronous set/reset and output enable signals can be formed using product terms on a per-macrocell or per-Function Block basis.

A DualEDGE flip-flop feature is also available on a per macrocell basis. This feature allows high performance synchronous operation based on lower frequency clocking to help reduce the total power consumption of the device.

Circuitry has also been included to divide one externally supplied global clock (GCK2) by eight different selections. This yields divide by even and odd clock frequencies.

The use of the clock divide (division by 2) and DualEDGE flip-flop gives the resultant CoolCLOCK feature.

DataGATE is a method to selectively disable inputs of the CPLD that are not of interest during certain points in time. By mapping a signal to the DataGATE function, lower power can be achieved due to reduction in signal switching.

Another feature that eases voltage translation is I/O banking. Two I/O banks are available on the CoolRunner-II Automotive 128-macrocell device that permit easy interfacing to 3.3V, 2.5V, 1.8V, and 1.5V devices.

The CoolRunner-II Automotive 128-macrocell CPLD is I/O compatible with various JEDEC I/O standards (see Table 1). This device is also 1.5V I/O compatible with the use of Schmitt-trigger inputs.

RealDigital Design Technology

Xilinx CoolRunner-II Automotive CPLDs are fabricated on a 0.18 micron process technology which is derived from leading edge FPGA product development. CoolRunner-II Automotive CPLDs employ RealDigital technology, a design technique that makes use of CMOS technology in both the fabrication and design methodology. RealDigital technology employs a cascade of CMOS gates to implement sum of products instead of traditional sense amplifier methodology.

Due to this technology, Xilinx CoolRunner-II Automotive CPLDs achieve both high-performance and low power operation.

Supported I/O Standards

The CoolRunner-II Automotive 128-macrocell device features LVCMOS and LVTTTL I/O implementations. See Table 1 for I/O standard voltages. The LVTTTL I/O standard is a general purpose EIA/JEDEC standard for 3.3V applications that use an LVTTTL input buffer and Push-Pull output buffer. The LVCMOS standard is used in 3.3V, 2.5V, 1.8V applications.

Table 1: I/O Standards for XA2C128

IOSTANDARD Attribute	Output V _{CCIO}	Input V _{CCIO}
LVTTTL	3.3	3.3
LVCMOS33	3.3	3.3
LVCMOS25	2.5	2.5
LVCMOS18	1.8	1.8
LVCMOS15 ⁽¹⁾	1.5	1.5

Notes:

1. LVCMOS15 requires use of Schmitt-trigger inputs.

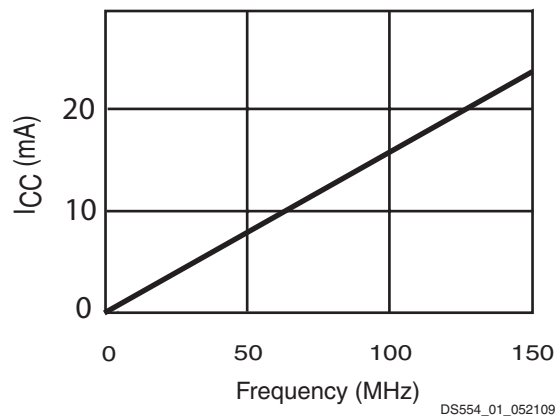

Figure 1: I_{CC} vs Frequency

Table 2: I_{CC} vs Frequency (LVCMOS 1.8V T_A = 25°C)⁽¹⁾

	Frequency (MHz)					
	0	25	50	75	100	150
Typical I _{CC} (mA)	0.019	3.97	7.95	11.92	15.89	23.83

Notes:

1. 16-bit up/down, Resettable binary counter (one counter per function block).

Absolute Maximum Ratings

Symbol	Description	Value	Units
V_{CC}	Supply voltage relative to ground	-0.5 to 2.0	V
V_{CCIO}	Supply voltage for output drivers	-0.5 to 4.0	V
$V_{JTAG}^{(2)}$	JTAG input voltage limits	-0.5 to 4.0	V
V_{CCAUX}	JTAG input supply voltage	-0.5 to 4.0	V
$V_{IN}^{(1)}$	Input voltage relative to ground	-0.5 to 4.0	V
$V_{TS}^{(1)}$	Voltage applied to 3-state output	-0.5 to 4.0	V
$T_{STG}^{(3)}$	Storage Temperature (ambient)	-65 to +150	°C
T_J	Junction Temperature	+125	°C

Notes:

- Maximum DC undershoot below GND must be limited to either 0.5V or 10 mA, whichever is easiest to achieve. During transitions, the device pins may undershoot to -2.0V or overshoot to +4.5V, provided this over or undershoot lasts less than 10 ns and with the forcing current being limited to 200 mA.
- Valid over commercial temperature range.
- For soldering guidelines and thermal considerations, see the [Device Package User Guide](#). For Pb-free packages, see [XAPP427](#).

Recommended Operating Conditions

Symbol	Parameter	Min	Max	Units	
V_{CC}	Supply voltage for internal logic and input buffers	Industrial $T_A = -40^{\circ}\text{C}$ to $+85^{\circ}\text{C}$	1.7	1.9	V
		Q-Grade $T_A = -40^{\circ}\text{C}$ to $+105^{\circ}\text{C}$ T_J Maximum = $+125^{\circ}\text{C}$	1.7	1.9	V
V_{CCIO}	Supply voltage for output drivers @ 3.3V operation	3.0	3.6	V	
	Supply voltage for output drivers @ 2.5V operation	2.3	2.7	V	
	Supply voltage for output drivers @ 1.8V operation	1.7	1.9	V	
	Supply voltage for output drivers @ 1.5V operation	1.4	1.6	V	
V_{CCAUX}	Supply voltage for JTAG programming	1.7	3.6	V	

DC Electrical Characteristics (Over Recommended Operating Conditions)

Symbol	Parameter	Test Conditions	Typical	Max.	Units
I_{CCSB}	Standby current Industrial	$V_{CC} = 1.9\text{V}$, $V_{CCIO} = 3.6\text{V}$	60	200	μA
I_{CCSB}	Standby current Q-grade	$V_{CC} = 1.9\text{V}$, $V_{CCIO} = 3.6\text{V}$	60	1.5	mA
$I_{CC}^{(1)}$	Dynamic current	$f = 1\text{ MHz}$	-	2.0	mA
		$f = 50\text{ MHz}$	-	12	mA
C_{JTAG}	JTAG input capacitance	$f = 1\text{ MHz}$	-	10	pF
C_{CLK}	Global clock input capacitance	$f = 1\text{ MHz}$	-	12	pF
C_{IO}	I/O capacitance	$f = 1\text{ MHz}$	-	10	pF
$I_{IL}^{(2)}$	Input leakage current	$V_{IN} = 0\text{V}$ or V_{CCIO} to 3.9V	-	± 10	μA
$I_{IH}^{(2)}$	I/O High-Z leakage	$V_{IN} = 0\text{V}$ or V_{CCIO} to 3.9V	-	± 10	μA

Notes:

- 16-bit up/down, Resettable binary counter (one counter per function block).

LVC MOS and LV TTL 3.3V DC Voltage Specifications

Symbol	Parameter	Test Conditions	Min.	Max.	Units
V_{CCIO}	Input source voltage		3.0	3.6	V
V_{IH}	High level input voltage		2.0	3.9	V
V_{IL}	Low level input voltage		-0.3	0.8	V
V_{OH}	High level output voltage, Industrial grade	$I_{OH} = -8 \text{ mA}, V_{CCIO} = 3\text{V}$	$V_{CCIO} - 0.4\text{V}$	-	V
		$I_{OH} = -0.1 \text{ mA}, V_{CCIO} = 3\text{V}$	$V_{CCIO} - 0.2\text{V}$	-	V
	High level output voltage, Q-grade	$I_{OH} = -4 \text{ mA}, V_{CCIO} = 3\text{V}$	$V_{CCIO} - 0.4\text{V}$	-	V
		$I_{OH} = -0.1 \text{ mA}, V_{CCIO} = 3\text{V}$	$V_{CCIO} - 0.2\text{V}$	-	V
V_{OL}	Low level output voltage, Industrial grade	$I_{OL} = 8 \text{ mA}, V_{CCIO} = 3\text{V}$	-	0.4	V
		$I_{OL} = 0.1 \text{ mA}, V_{CCIO} = 3\text{V}$	-	0.2	V
	Low level output voltage, Q-grade	$I_{OL} = 4 \text{ mA}, V_{CCIO} = 3\text{V}$	-	0.4	V
		$I_{OL} = 0.1 \text{ mA}, V_{CCIO} = 3\text{V}$	-	0.2	V

LVC MOS 2.5V DC Voltage Specifications

Symbol	Parameter	Test Conditions	Min.	Max.	Units
V_{CCIO}	Input source voltage		2.3	2.7	V
V_{IH}	High level input voltage		1.7	$V_{CCIO} + 0.3^{(1)}$	V
V_{IL}	Low level input voltage		-0.3	0.7	V
V_{OH}	High level output voltage, Industrial grade	$I_{OH} = -8 \text{ mA}, V_{CCIO} = 2.3\text{V}$	$V_{CCIO} - 0.4\text{V}$	-	V
		$I_{OH} = -0.1 \text{ mA}, V_{CCIO} = 2.3\text{V}$	$V_{CCIO} - 0.2\text{V}$	-	V
	High level output voltage, Q-grade	$I_{OH} = -4 \text{ mA}, V_{CCIO} = 2.3\text{V}$	$V_{CCIO} - 0.4\text{V}$	-	V
		$I_{OH} = -0.1 \text{ mA}, V_{CCIO} = 2.3\text{V}$	$V_{CCIO} - 0.2\text{V}$	-	V
V_{OL}	Low level output voltage, Industrial grade	$I_{OL} = 8 \text{ mA}, V_{CCIO} = 2.3\text{V}$	-	0.4	V
		$I_{OL} = 0.1 \text{ mA}, V_{CCIO} = 2.3\text{V}$	-	0.2	V
	Low level output voltage, Q-grade	$I_{OL} = 4 \text{ mA}, V_{CCIO} = 2.3\text{V}$	-	0.4	V
		$I_{OL} = 0.1 \text{ mA}, V_{CCIO} = 2.3\text{V}$	-	0.2	V

- The V_{IH} Max value represents the JEDEC specification for LVC MOS25. The CoolRunner-II input buffer can tolerate up to 3.9V without physical damage.

LVC MOS 1.8V DC Voltage Specifications

Symbol	Parameter	Test Conditions	Min.	Max.	Units
V_{CCIO}	Input source voltage		1.7	1.9	V
V_{IH}	High level input voltage		$0.65 \times V_{CCIO}$	$V_{CCIO} + 0.3^{(1)}$	V
V_{IL}	Low level input voltage		-0.3	$0.35 \times V_{CCIO}$	V
V_{OH}	High level output voltage, Industrial grade	$I_{OH} = -8 \text{ mA}, V_{CCIO} = 1.7\text{V}$	$V_{CCIO} - 0.45$	-	V
		$I_{OH} = -0.1 \text{ mA}, V_{CCIO} = 1.7\text{V}$	$V_{CCIO} - 0.2$	-	V
	High level output voltage, Q-grade	$I_{OH} = -4 \text{ mA}, V_{CCIO} = 1.7\text{V}$	$V_{CCIO} - 0.45$	-	V
		$I_{OH} = -0.1 \text{ mA}, V_{CCIO} = 1.7\text{V}$	$V_{CCIO} - 0.2$	-	V
V_{OL}	Low level output voltage, Industrial grade	$I_{OL} = 8 \text{ mA}, V_{CCIO} = 1.7\text{V}$	-	0.45	V
		$I_{OL} = 0.1 \text{ mA}, V_{CCIO} = 1.7\text{V}$	-	0.2	V
	Low level output voltage, Q-grade	$I_{OL} = 4 \text{ mA}, V_{CCIO} = 1.7\text{V}$	-	0.45	V
		$I_{OL} = 0.1 \text{ mA}, V_{CCIO} = 1.7\text{V}$	-	0.2	V

- The V_{IH} Max value represents the JEDEC specification for LVC MOS18. The CoolRunner-II input buffer can tolerate up to 3.9V without physical damage.

LVC MOS 1.5V DC Voltage Specifications⁽¹⁾

Symbol	Parameter	Test Conditions	Min.	Max.	Units
V_{CCIO}	Input source voltage	-	1.4	1.6	V
V_{T+}	Input hysteresis threshold voltage	-	$0.5 \times V_{CCIO}$	$0.8 \times V_{CCIO}$	V
V_{T-}		-	$0.2 \times V_{CCIO}$	$0.5 \times V_{CCIO}$	V
V_{OH}	High level output voltage, Industrial grade	$I_{OH} = -8 \text{ mA}, V_{CCIO} = 1.4\text{V}$	$V_{CCIO} - 0.45$	-	V
		$I_{OH} = -0.1 \text{ mA}, V_{CCIO} = 1.4\text{V}$	$V_{CCIO} - 0.2$	-	V
	High level output voltage, Q-grade	$I_{OH} = -4 \text{ mA}, V_{CCIO} = 1.4\text{V}$	$V_{CCIO} - 0.45$	-	V
		$I_{OH} = -0.1 \text{ mA}, V_{CCIO} = 1.4\text{V}$	$V_{CCIO} - 0.2$	-	V
V_{OL}	High level output voltage, Industrial grade	$I_{OL} = 8 \text{ mA}, V_{CCIO} = 1.4\text{V}$	-	0.4	V
		$I_{OL} = 0.1 \text{ mA}, V_{CCIO} = 1.4\text{V}$	-	0.2	V
	High level output voltage, Q-grade	$I_{OL} = 4 \text{ mA}, V_{CCIO} = 1.4\text{V}$	-	0.4	V
		$I_{OL} = 0.1 \text{ mA}, V_{CCIO} = 1.4\text{V}$	-	0.2	V

Notes:

- Hysteresis used on 1.5V inputs.

Schmitt Trigger Input DC Voltage Specifications

Symbol	Parameter	Test Conditions	Min.	Max.	Units
V_{CCIO}	Input source voltage	-	1.4	3.9	V
V_{T+}	Input hysteresis threshold voltage	-	$0.5 \times V_{CCIO}$	$0.8 \times V_{CCIO}$	V
V_{T-}		-	$0.2 \times V_{CCIO}$	$0.5 \times V_{CCIO}$	V

AC Electrical Characteristics Over Recommended Operating Conditions

Symbol	Parameter	-7		-8		Units
		Min.	Max.	Min.	Max.	
T_{PD1}	Propagation delay single p-term	-	7.0	-	7.0	ns
T_{PD2}	Propagation delay OR array	-	7.5	-	7.5	ns
T_{SUD}	Direct input register set-up time	4.6	-	4.6	-	ns

Symbol	Parameter	-7		-8		Units
		Min.	Max.	Min.	Max.	
T _{SU1}	Setup time fast (single p-term)	3.0	-	3.0	-	ns
T _{SU2}	Setup time (OR array)	3.5	-	3.5	-	ns
T _{HD}	Direct input register hold time	0.0	-	0.0	-	ns
T _H	Hold time (Or array or p-term)	0.0	-	0.0	-	ns
T _{CO}	Clock to output	-	5.4	-	5.4	ns
F _{TOGGLE} ⁽¹⁾	Internal toggle rate	-	300	-	300	MHz
F _{SYSTEM1} ⁽²⁾	Maximum system frequency	-	152	-	152	MHz
F _{SYSTEM2} ⁽²⁾	Maximum system frequency	-	141	-	141	MHz
F _{EXT1} ⁽³⁾	Maximum external frequency	-	119	-	119	MHz
F _{EXT2} ⁽³⁾	Maximum external frequency	-	112	-	112	MHz
T _{PSUD}	Direct input register p-term clock setup time	3.1	-	3.1	-	ns
T _{PSU1}	P-term clock setup time (single p-term)	1.5	-	1.5	-	ns
T _{PSU2}	P-term clock setup time (OR array)	2.0	-	2.0	-	ns
T _{PHD}	Direct input register p-term clock hold time	0.2	-	0.2	-	ns
T _{PH}	P-term clock hold	1.0	-	1.0	-	ns
T _{PCO}	P-term clock to output	-	7.3	-	7.3	ns
T _{OE} /T _{OD}	Global OE to output enable/disable	-	7.5	-	7.5	ns
T _{POE} /T _{POD}	P-term OE to output enable/disable	-	8.5	-	8.5	ns
T _{MOE} /T _{MOD}	Macrocell driven OE to output enable/disable	-	9.9	-	9.9	ns
T _{PAO}	P-term set/reset to output valid	-	8.1	-	8.1	ns
T _{AO}	Global set/reset to output valid	-	7.6	-	7.6	ns
T _{SUEC}	Register clock enable setup time	3.5	-	3.5	-	ns
T _{HEC}	Register clock enable hold time	0.0	-	0.0	-	ns
T _{CW}	Global clock pulse width High or Low	1.6	-	1.6	-	ns
T _{APRPW}	Asynchronous preset/reset pulse width (High or Low)	7.5	-	7.5	-	ns
T _{PCW}	P-term pulse width High or Low	7.5	-	7.5	-	ns
T _{DGSU}	Set-up before DataGATE latch assertion	0.0	-	0.0	-	ns
T _{DGH}	Hold to DataGATE latch assertion	6.0	-	6.0	-	ns
T _{DGR}	DataGATE recovery to new data	-	9.0	-	9.0	ns
T _{DGW}	DataGATE low pulse width	4.0	-	4.0	-	ns
T _{CDRSU}	CDRST setup time before falling edge GCLK2	2.0	-	2.0	-	ns
T _{CDRH}	Hold time CDRST after falling edge GCLK2	0.0	-	0.0	-	ns
T _{CONFIG} ⁽⁴⁾	Configuration time	-	350	-	350	us

Notes:

1. F_{TOGGLE} is the maximum clock frequency to which a T flip-flop can reliably toggle (see the CoolRunner-II Automotive CPLD family data sheet).
2. F_{SYSTEM1} is the internal operating frequency for a device with 16-bit resettable binary counter through one p-term per macrocell while F_{SYSTEM2} is through the OR array (one counter per function block).
3. F_{EXT1} (1/T_{SU1}+T_{CO}) is the maximum external frequency using one p-term while F_{EXT2} is through the OR array.
4. Typical configuration current during T_{CONFIG} is 10 mA.

Internal Timing Parameters

Symbol	Parameter ⁽¹⁾	-7		-8		Units
		Min.	Max.	Min.	Max.	
Buffer Delays						
T _{IN}	Input buffer delay	-	2.6	-	2.6	ns
T _{DIN}	Direct data register input delay	-	5.3	-	5.3	ns
T _{GCK}	Global Clock buffer delay	-	2.1	-	2.1	ns
T _{GSR}	Global set/reset buffer delay	-	3.5	-	3.5	ns
T _{GTS}	Global 3-state buffer delay	-	3.0	-	3.0	ns
T _{OUT}	Output buffer delay	-	2.6	-	2.6	ns
T _{EN}	Output buffer enable/disable delay	-	4.5	-	4.5	ns
P-term Delays						
T _{CT}	Control term delay	-	1.4	-	1.4	ns
T _{LOGI1}	Single P-term delay adder	-	1.1	-	1.1	ns
T _{LOGI2}	Multiple P-term delay adder	-	0.5	-	0.5	ns
Macrocell Delay						
T _{PDI}	Input to output valid	-	0.7	-	0.7	ns
T _{LDI}	Setup before clock (transparent latch)	-	2.5	-	2.5	ns
T _{SUI}	Setup before clock	1.4	-	1.4	-	ns
T _{HI}	Hold after clock	0.0	-	0.0	-	ns
T _{ECSU}	Enable clock setup time	1.6	-	1.6	-	ns
T _{ECHO}	Enable clock hold time	0.0	-	0.0	-	ns
T _{COI}	Clock to output valid	-	0.7	-	0.7	ns
T _{AOI}	Set/reset to output valid	-	1.5	-	1.5	ns
Feedback Delays						
T _F	Feedback delay	-	3.4	-	3.4	ns
T _{OEM}	Macrocell to global OE delay	-	2.6	-	2.6	ns
I/O Standard Time Adder Delays 1.5V CMOS						
T _{HYS15}	Hysteresis input adder	-	4.0	-	4.0	ns
T _{OUT15}	Output adder	-	1.0	-	1.0	ns
T _{SLEW15}	Output slew rate adder	-	4.0	-	4.0	ns
I/O Standard Time Adder Delays 1.8V CMOS						
T _{HYS18}	Hysteresis input adder	-	4.0	-	4.0	ns
T _{OUT18}	Output adder	-	0.0	-	0.0	ns
T _{SLEW18}	Output slew rate adder	-	4.0	-	4.0	ns

Internal Timing Parameters (Continued)

Symbol	Parameter ⁽¹⁾	-7		-8		Units
		Min.	Max.	Min.	Max.	
I/O Standard Time Adder Delays 2.5V CMOS						
T _{IN25}	Standard input adder	-	0.7	-	0.7	ns
T _{HYS25}	Hysteresis input adder	-	3.0	-	3.0	ns
T _{OUT25}	Output adder	-	0.9	-	0.9	ns
T _{SLEW25}	Output slew rate adder	-	4.0	-	4.0	ns
I/O Standard Time Adder Delays 3.3V CMOS/TTL						
T _{IN33}	Standard input adder	-	0.6	-	0.6	ns
T _{HYS33}	Hysteresis input adder	-	3.0	-	3.0	ns
T _{OUT33}	Output adder	-	1.4	-	1.4	ns
T _{SLEW33}	Output slew rate adder	-	4.0	-	4.0	ns

Notes:

1. 1.5 ns input pin signal rise/fall.

Switching Characteristics

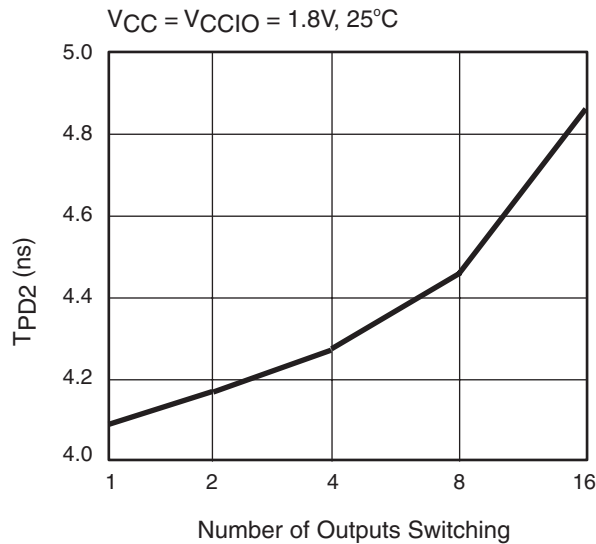

DS554_02_052109

Figure 2: Derating Curve for T_{PD}

Switching Test Conditions

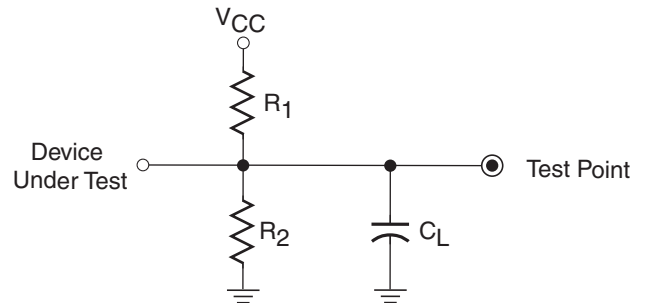

Output Type	R ₁	R ₂	C _L
LVTTTL33	268Ω	235Ω	35 pF
LVC MOS33	275Ω	275Ω	35 pF
LVC MOS25	188Ω	188Ω	35 pF
LVC MOS18	112.5Ω	112.5Ω	35 pF
LVC MOS15	150Ω	150Ω	35 pF

Notes:

1. C_L includes test fixtures and probe capacitance.
2. 1.5 ns maximum rise/fall times on inputs.

DS554_03_052109

Figure 3: AC Load Circuits

Typical I/V Output Curves

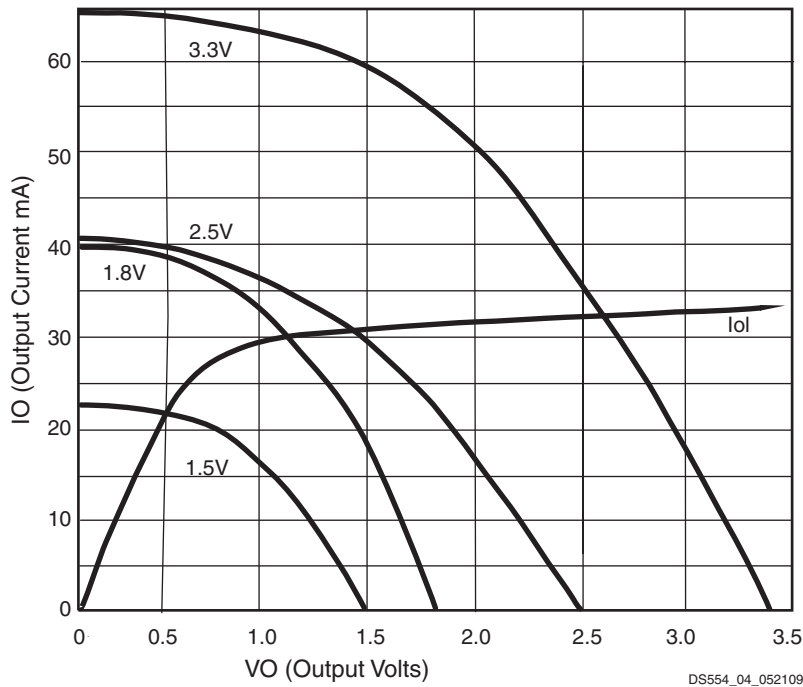

Figure 4: Typical I/V Curves for XA2C128

Pin Descriptions

Function Block	Macro-cell	VQG100	CPG132	I/O Bank
1	1	13	G1	2
1	2	-	F1	2
1	3	12	F2	2
1	4	11	F3	2
1	5	10	E1	2
1	6	9	E2	2
1	7	-	-	-
1	8	-	-	-
1	9	-	-	-
1	10	-	-	-
1	11	8	E3	2
1	12	7	D1	2
1	13	6	D2	2
1	14	-	C1	2
1(GTS1)	15	4	C2	2
1(GTS0)	16	3	C3	2

Pin Descriptions (Continued)

Function Block	Macro-cell	VQG100	CPG132	I/O Bank
2	1	-	G2	1
2	2	14	G3	1
2	3	15	H1	1
2	4	16	H2	1
2	5	17	H3	1
2	6	18	J1	1
2	7	-	-	-
2	8	-	-	-
2	9	-	-	-
2	10	-	-	-
2	11	19	J2	1
2	12	-	K1	1
2(GCK0)	13	22	K3	1
2(GCK1)	14	23	L2	1
2(CDRST)	15	24	M2	1
2(GCK2)	16	27	N2	1

Pin Descriptions (Continued)

Function Block	Macro-cell	VQG100	CPG132	I/O Bank
3	1	-	B1	2
3(GTS3)	2	2	B2	2
3(GTS2)	3	1	A1	2
3(GSR)	4	99	A3	2
3	5	97	B4	2
3	6	96	A4	2
3	7	95	C5	2
3	8	-	-	-
3	9	-	-	-
3	10	-	-	-
3	11	94	B5	2
3	12		A5	2
3	13	93	C6	2
3	14	92	B6	2
3	15	91	A6	2
3	16	90	C7	2
4(DGE)	1	28	P2	1
4	2	-	M3	1
4	3	-	N3	1
4	4	29	P3	1
4	5	30	M4	1
4	6	32	M5	1
4	7	33	N5	1
4	8	-	-	-
4	9	-	-	-
4	10	-	-	-
4	11	34	P5	1
4	12	35	M6	1
4	13	36	N6	1
4	14	37	P6	1
4	15	39	N7	1
4	16	40	M7	1

Pin Descriptions (Continued)

Function Block	Macro-cell	VQG100	CPG132	I/O Bank
5	1	65	G13	2
5	2	66	G12	2
5	3	67	F14	2
5	4	-	F13	2
5	5	68	F12	2
5	6	-	E13	2
5	7	70	E12	2
5	8	-	-	-
5	9	-	-	-
5	10	-	-	-
5	11	71	D14	2
5	12	72	D13	2
5	13	73	D12	2
5	14	74	C14	2
5	15	76	B13	2
5	16	-	A13	2
6	1	64	H12	1
6	2	63	H13	1
6	3	61	J13	1
6	4	60	J12	1
6	5	59	K14	1
6	6	58	K13	1
6	7	-	-	-
6	8	-	-	-
6	9	-	-	-
6	10	-	-	-
6	11	-	L14	1
6	12	56	L13	1
6	13	-	L12	1
6	14	55	M14	1
6	15	-	M13	1
6	16	54	M12	1

Pin Descriptions (Continued)

Function Block	Macro-cell	VQG100	CPG132	I/O Bank
7	1	77	C12	2
7	2	78	B12	2
7	3	-	A12	2
7	4	79	C11	2
7	5	80	B11	2
7	6	81	A11	2
7	7	-	C10	2
7	8	-	-	-
7	9	-	-	-
7	10	-	-	-
7	11	82	A10	2
7	12	-	C9	2
7	13	85	A8	2
7	14	86	B8	2
7	15	87	C8	2
7	16	89	B7	2

Pin Descriptions (Continued)

Function Block	Macro-cell	VQG100	CPG132	I/O Bank
8	1	-	N14	1
8	2	53	N13	1
8	3	52	P14	1
8	4	50	P12	1
8	5	-	M11	1
8	6	49	N11	1
8	7	-	-	-
8	8	-	-	-
8	9	-	-	-
8	10	-	-	-
8	11	-	P11	1
8	12	46	P10	1
8	13	44	P9	1
8	14	43	M8	1
8	15	42	N8	1
8	16	41	P8	1

Notes:

1. GTS = global output enable, GSR = global reset/set, GCK = global clock, CDRST = clock divide reset, DGE = DataGATE enable.
2. GCK, GSR, and GTS pins can also be used for general purpose I/O.

XA2C128 JTAG, Power/Ground, No Connect Pins and Total User I/O

Pin Type	VQG100 ⁽¹⁾	CPG132 ⁽¹⁾
TCK	48	M10
TDI	45	M9
TDO	83	B9
TMS	47	N10
V _{CCAUX} (JTAG supply voltage)	5	D3
Power internal (V _{CC})	26, 57	P1, K12, A2
Power Bank 1 I/O (V _{CCI01})	20, 38, 51	J3, P7, G14, P13
Power Bank 2 I/O (V _{CCI02})	88, 98	A14, C4, A7
Ground	21, 25, 31, 62, 69, 75, 84, 100	K2, N1, P4, N9, N12, J14, H14, E14, B14, A9, B3
No connects	-	L1, L3, M1, N4, C13, B10
Total user I/O (including dual function pins)	80	100

Notes:

- Pin compatible with all larger and smaller densities except where I/O banking is used.

Ordering Information

Part Number	Pin/Ball Spacing	θ_{JA} (C/Watt)	θ_{JC} (C/Watt)	Package Type	Package Body Dimensions	I/O	Ind. (I) ⁽¹⁾ Hi-T (Q)
XA2C128-7VQG100I	0.5mm	47.5	12.5	Very Thin Quad Flat Pack; Pb-free	14mm x 14mm	80	I
XA2C128-8VQG100Q	0.5mm	47.5	12.5	Very Thin Quad Flat Pack; Pb-free	14mm x 14mm	80	Q
XA2C128-7CPG132I	0.5mm	72.4	15.7	Chip Scale Package; Pb-free	8mm x 8mm	100	I
XA2C128-8CPG132Q	0.5mm	72.4	15.7	Chip Scale Package; Pb-free	8mm x 8mm	100	Q

Notes: I = Industrial (T_A = -40° C to +85° C); Q = Automotive (T_A = -40° C to +105° C with T_J Maximum = +125° C).

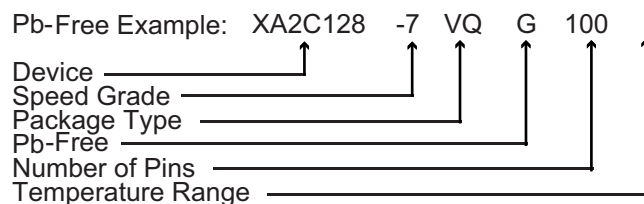

Device Part Marking

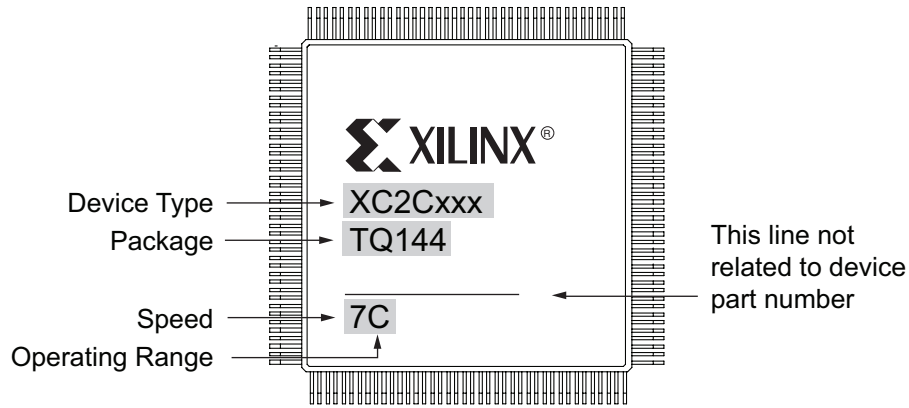

Part Marking for all non chip scale packages

DS554_05_052109

Figure 5: Sample Package with Part Marking

Note: Due to the small size of chip scale packages, the complete ordering part number cannot be included on the package marking. Part marking on chip scale packages by line are:

- Line 1 = X (Xilinx logo) then truncated part number
- Line 2 = Not related to device part number
- Line 3 = Not related to device part number
- Line 4 = Package code, speed, operating temperature, three digits not related to device part number. Package codes: C6 = CPG132.

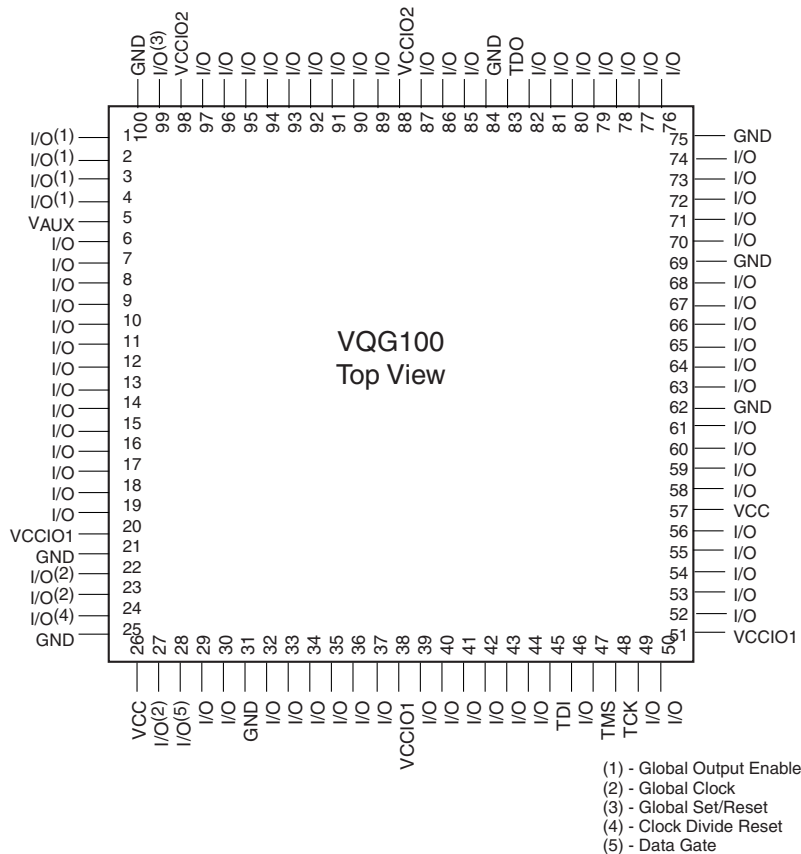

DS554_06_052109

Figure 6: VQG100 Very Thin Quad Flat Pack

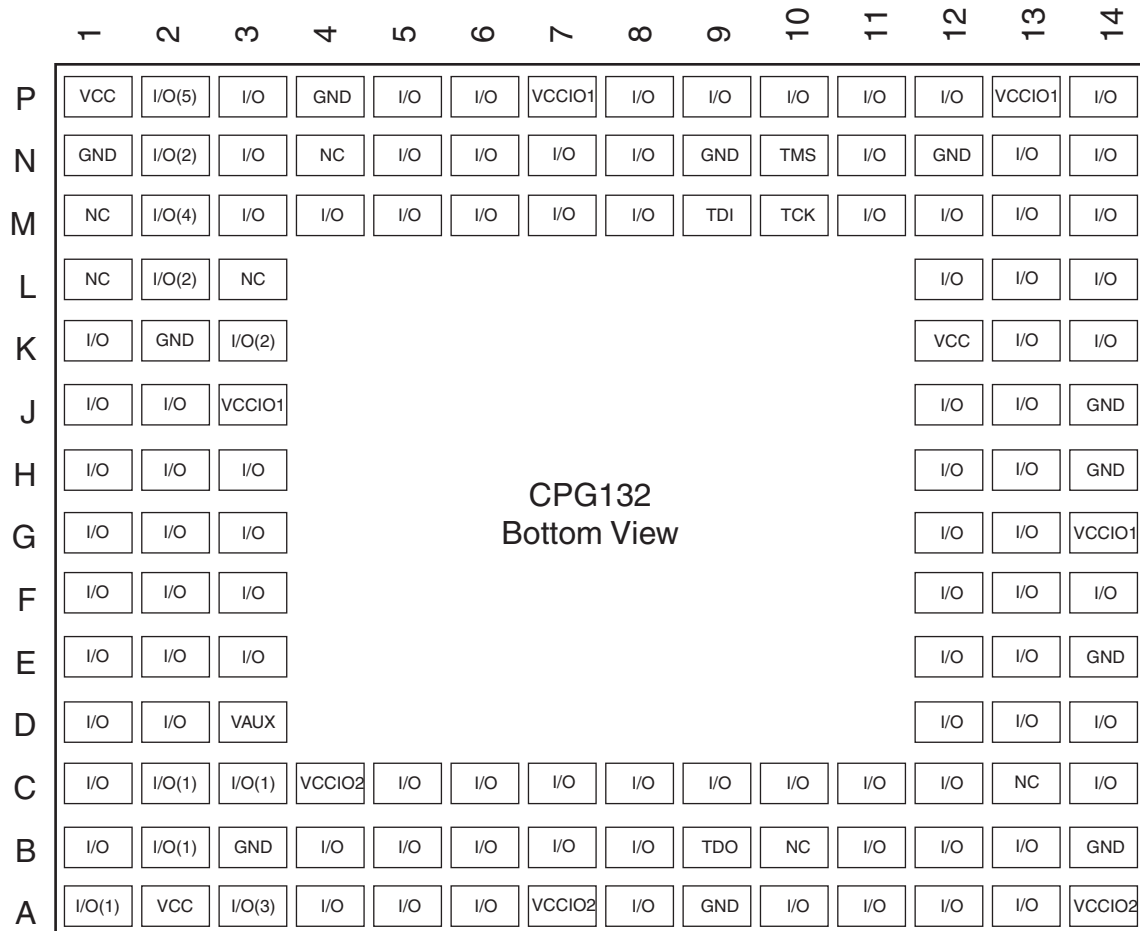

CPG132
Bottom View

- (1) - Global Output Enable
- (2) - Global Clock
- (3) - Global Set/Reset
- (4) - Clock Divide Reset
- (5) - DataGATE Enable

DS554_07_052109

Figure 7: CP132 Chip Scale Package

CoolRunner-II Automotive Requirements and Recommendations

Requirements

The following requirements are for all automotive applications:

1. Use a monotonic, fast ramp power supply to power up CoolRunner-II. A V_{CC} ramp time of less than 1 ms is required.
2. Do not float I/O pins during device operation. Floating I/O pins can increase I_{CC} as input buffers will draw 1-2 mA per floating input. In addition, when I/O pins are floated, noise can propagate to the center of the CPLD. I/O pins should be appropriately terminated with bus-hold or pull-up. Unused I/Os can also be configured as C_{GND} (programmable GND).
3. Do not drive I/O pins without V_{CC}/V_{CCIO} powered.
4. Sink current when driving LEDs. Because all Xilinx CPLDs have N-channel pull-down transistors on outputs, it is required that an LED anode is sourced through a resistor externally to V_{CC}. Consequently, this will give the brightest solution.
5. Avoid pull-down resistors. Always use external pull-up resistors if external termination is required. This is because the CoolRunner-II Automotive CPLD, which includes some I/O driving circuits beyond the input and output buffers, may have contention with external pull-down resistors, and, consequently, the I/O will not switch as expected.

6. Do not drive I/Os pins above the V_{CCIO} assigned to its I/O bank.
 - a. The current flow can go into V_{CCIO} and affect a user voltage regulator.
 - b. It can also increase undesired leakage current associated with the device.
 - c. If done for too long, it can reduce the life of the device.
7. Do not rely on the I/O states before the CPLD configures. During power up, the CPLD I/Os may be affected by internal or external signals.
8. Use a voltage regulator which can provide sufficient current during device power up. As a rule of thumb, the regulator needs to provide at least three times the peak current while powering up a CPLD in order to guarantee the CPLD can configure successfully.
9. Ensure external JTAG terminations for TMS, TCK, TDI, TDO should comply with the IEEE 1149.1. All Xilinx CPLDs have internal weak pull-ups on TDI, TMS, and TCK.
10. Attach all CPLD V_{CC} and GND pins in order to have necessary power and ground supplies around the CPLD.
11. Decouple all V_{CC} and V_{CCIO} pins with capacitors of 0.01 μF and 0.1 μF closest to the pins for each V_{CC}/V_{CCIO} -GND pair.
12. Configure I/Os properly. CoolRunner-II Automotive CPLDs have I/O banks; therefore, signals must be assigned to appropriate banks (LVCMOS33, LVCMOS18 ...)
2. Include JTAG stakes on the PCB. JTAG stakes can be used to test the part on the PCB. They add benefit in reprogramming part on the PCB, inspecting chip internals with INTEST, identifying stuck pins, and inspecting programming patterns (if not secured).
3. CoolRunner-II Automotive CPLDs work with any power sequence, but it is preferable to power the V_{CCi} (internal V_{CC}) before the V_{CCIO} for the applications in which any glitches from device I/Os are unwanted.
4. Do not disregard report file warnings. Software identifies potential problems when compiling, so the report file is worth inspecting to see exactly how your design is mapped onto the logic.
5. Understand the Timing Report. This report file provides a speed summary along with warnings. Read the timing file (*.tim) carefully. Analyze key signal chains to determine limits to given clock(s) based on logic analysis.
6. Review Fitter Report equations. Equations can be shown in ABEL-like format, or can also be displayed in Verilog or VHDL formats. The Fitter Report also includes switch settings that are very informative of other device behaviors.
7. Let design software define pinouts if possible. Xilinx CPLD software works best when it selects the I/O pins and manages resources for users. It can spread signals around and improve pin-locking. If users must define pins, plan resources in advance.
8. Perform a post-fit simulation for all speeds to identify any possible problems (such as race conditions) that might occur when fast-speed silicon is used instead of slow-speed silicon.
9. Distribute SSOs (Simultaneously Switching Outputs) evenly around the CPLD to reduce switching noise.
10. Terminate high speed outputs to eliminate noise caused by very fast rising/falling edges.

Recommendations

The following recommendations are for all automotive applications.

1. Use strict synchronous design (only one clocking event) if possible. A synchronous system is more robust than an asynchronous one.

Additional Information

Additional information is available for the following CoolRunner-II topics:

- [XAPP784](#): Bulletproof CPLD Design Practices
- [XAPP375](#): Timing Model
- [XAPP376](#): Logic Engine
- [XAPP378](#): Advanced Features
- [XAPP382](#): I/O Characteristics
- [XAPP389](#): Powering CoolRunner-II
- [XAPP399](#): Assigning VREF Pins

These and other application notes can be accessed at:

[CoolRunner-II Documentation](#)

Package specifications can be accessed at:

[Device Packages](#)

Revision History

The following table shows the revision history for this document.

Date	Version	Revision
10/31/06	1.0	Initial Xilinx release.
05/05/07	1.1	Change to V_{IH} specification for 3.3V, 2.5V and 1.8V LVCMOS. Corrections to t_{SUI} , t_{ECSU} , t_F and t_{OEM} for the -7 speed grade. Values now match the software. There were no changes to silicon or characterization.
06/09/09	1.2	Corrected XA2C128-8VQG100Q part number in Ordering Information .

Notice of Disclaimer

THE XILINX HARDWARE FPGA AND CPLD DEVICES REFERRED TO HEREIN (“PRODUCTS”) ARE SUBJECT TO THE TERMS AND CONDITIONS OF THE XILINX LIMITED WARRANTY WHICH CAN BE VIEWED AT <http://www.xilinx.com/warranty.htm>. THIS LIMITED WARRANTY DOES NOT EXTEND TO ANY USE OF PRODUCTS IN AN APPLICATION OR ENVIRONMENT THAT IS NOT WITHIN THE SPECIFICATIONS STATED IN THE XILINX DATA SHEET. ALL SPECIFICATIONS ARE SUBJECT TO CHANGE WITHOUT NOTICE. PRODUCTS ARE NOT DESIGNED OR INTENDED TO BE FAIL-SAFE OR FOR USE IN ANY APPLICATION REQUIRING FAIL-SAFE PERFORMANCE, SUCH AS LIFE-SUPPORT OR SAFETY DEVICES OR SYSTEMS, OR ANY OTHER APPLICATION THAT INVOKES THE POTENTIAL RISKS OF DEATH, PERSONAL INJURY, OR PROPERTY OR ENVIRONMENTAL DAMAGE (“CRITICAL APPLICATIONS”). USE OF PRODUCTS IN CRITICAL APPLICATIONS IS AT THE SOLE RISK OF CUSTOMER, SUBJECT TO APPLICABLE LAWS AND REGULATIONS.

Automotive Applications Disclaimer

XILINX PRODUCTS ARE NOT DESIGNED OR INTENDED TO BE FAIL-SAFE, OR FOR USE IN ANY APPLICATION REQUIRING FAIL-SAFE PERFORMANCE, SUCH AS APPLICATIONS RELATED TO: (I) THE DEPLOYMENT OF AIRBAGS, (II) CONTROL OF A VEHICLE, UNLESS THERE IS A FAIL-SAFE OR REDUNDANCY FEATURE (WHICH DOES NOT INCLUDE USE OF SOFTWARE IN THE XILINX DEVICE TO IMPLEMENT THE REDUNDANCY) AND A WARNING SIGNAL UPON FAILURE TO THE OPERATOR, OR (III) USES THAT COULD LEAD TO DEATH OR PERSONAL INJURY. CUSTOMER ASSUMES THE SOLE RISK AND LIABILITY OF ANY USE OF XILINX PRODUCTS IN SUCH APPLICATIONS.

X-ON Electronics

Largest Supplier of Electrical and Electronic Components

Click to view similar products for [CPLD - Complex Programmable Logic Devices](#) category:

Click to view products by [Xilinx](#) manufacturer:

Other Similar products are found below :

[5962-9952001QYA](#) [5M1270ZT144I5](#) [M4A5-12864-10YNI](#) [M4A5-12864-12YNI](#) [M4A5-3232-5VNC](#) [M4A5-6432-7VNC](#) [M4A5-6432-7VNI](#)
[CY3LV002-10JC](#) [CY7C344B-15JI](#) [EPM7064LC68-10](#) [ISPLSI 1032-90LJ](#) [ISPLSI 1048-70LQ](#) [LA4064V-75TN44E](#) [LC4064ZC-5MN56C](#)
[M4A3-3232-10VC](#) [M4A5-256128-12YNI](#) [MACH435Q-20JC](#) [ISPLSI 1032-60LJ](#) [ISPLSI 1032-80LJ](#) [ISPLSI 1048-50LQ](#) [LA4032V-75TN44E](#)
[LC4032ZC-5MN56I](#) [5962-9759901QZC](#) [XC95288XL-10CS280I](#) [LC4032ZC-75MN56I](#) [LC5512MV-45F256C](#) [M4A5-6432-10VNI](#)
[ISPLSI2096A-80LT128I](#) [M4A3-256192-10FAI](#) [LA4128V-75TN128E](#) [ISPLSI5256VA-100LB208](#) [M4A3-3232-5VC48](#) [M4A3-64/32-](#)
[12VNI48](#) [CP4878DM](#) [M4A3-256/160-7YC](#) [M4A3-256/192-7FAC](#) [M4A3-32/32-10VNC48](#) [M4A3-384/192-10FANC](#) [M4A3-512/160-14YI](#)
[M4A3-512/192-7FAC](#) [M4A3-64/32-10VNC](#) [M4A5-128/64-7YI](#) [M4A5-192/96-10VC](#) [M4A5-192/96-10VI](#) [M4A5-256/128-10YNC](#) [M4A5-](#)
[256/128-7YC](#) [M4A5-32/32-10VC](#) [M4A5-64/32-10VNC](#) [M5-192/120-10YI/1](#) [M5-320/160-10YI](#)