

DO NOT SCALE FROM THIS PRINT

FTS-1XX-XX-XX-XX-XX

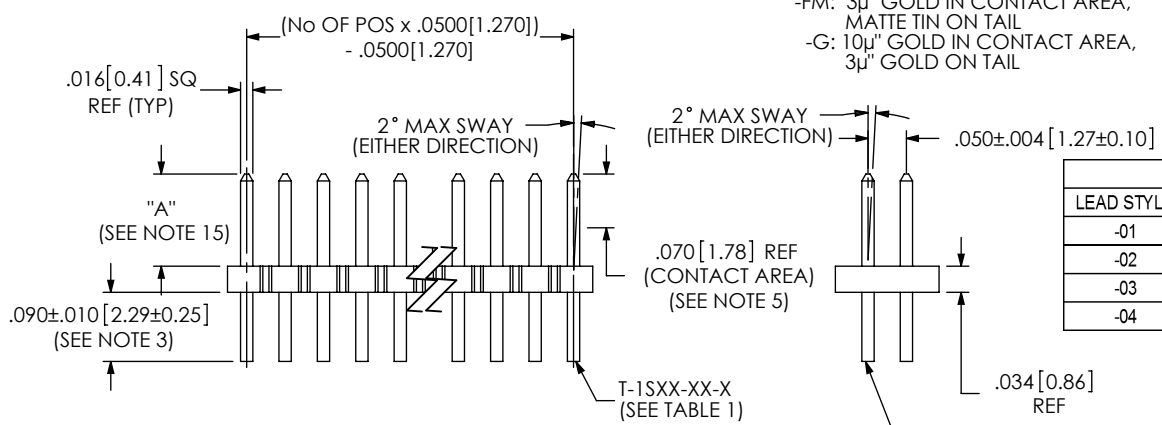
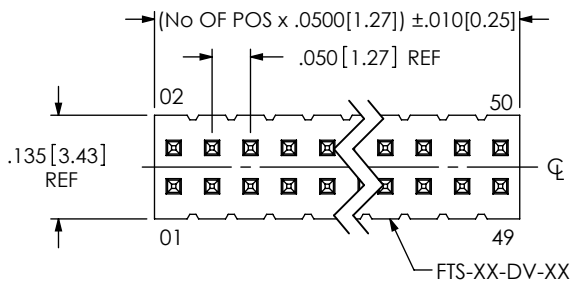

- No OF POSITIONS
-02 THRU -50 (UNSHROUDED)
-06 THRU -46 (SHROUDED)
- LEAD STYLE
SEE TABLE 1
- PLATING SPECIFICATION
- L: 10μ" GOLD IN CONTACT AREA, MATTE TIN ON TAIL
 - F: 3μ" GOLD IN CONTACT AREA, MATTE TIN ON TAIL
 - S: 30μ" GOLD IN CONTACT AREA, MATTE TIN ON TAIL
 - H: 30μ" GOLD IN CONTACT AREA, 3μ" GOLD ON TAIL
 - SM: 30μ" GOLD IN CONTACT AREA, MATTE TIN ON TAIL
 - LM: 10μ" GOLD IN CONTACT AREA, MATTE TIN ON TAIL
 - FM: 3μ" GOLD IN CONTACT AREA, MATTE TIN ON TAIL
 - G: 10μ" GOLD IN CONTACT AREA, 3μ" GOLD ON TAIL

- OPTIONS
- P: PICK AND PLACE PAD (USE PPP-25) (AVAILABLE ON POSITIONS 04 THRU 50) (SEE FIG 5, SHT 2 & FIG 7, SHT 3) (USE PPP-25-NT FOR TAPE & REEL)
 - TR: TAPE & REEL PACKAGING (SEE FIG 10, SHT 4) (SEE NOTE 14 & 16) (ONLY AVAILABLE WITH -DV OPTION)
 - S: END SHROUDS (SEE FIG 3, SHT 2 & FIG 6 SHT 3) (LEAD STYLE -02 & -03 ONLY) (05 POS MINIMUM, 46 POS MAXIMUM) (NOT AVAILABLE WITH -A OPTION; ORDER -SA FOR ALIGNMENT PIN WITH SHROUD) (SEE NOTES 6 & 7)
 - SA: END SHROUDS W/ ALIGNMENT PINS (SEE FIG 4, SHT 2 & FIG 8, SHT 3) (LEAD STYLE -02 & -03 ONLY) (05 POS MINIMUM, 46 POS MAXIMUM) (SEE NOTES 6 & 7)
 - A: MOLDED ALIGNMENT PIN (USE FTS-XX-DV-XX) (ONLY AVAILABLE IN -DV OPTION, 5 POS MINIMUM) (SEE FIG 9, SHT 3) (NOT AVAILABLE WITH -S OPTION; ORDER -SA FOR ALIGNMENT PIN AND SHROUD)
- TAIL OPTION
- D: DOUBLE ROW THROUGH HOLE
 - DV: DOUBLE ROW VERTICAL SURFACE MOUNT

TABLE 1

LEAD STYLE	"A"	HAND FILL	MICRO HEADER MACHINE	BKT MACHINE
-01	0.120 [3.05]	T-1S15-03-X	T-1S15-03-X	T-1S15-03-X
-02	0.075 [1.91]	T-1S15-03-X	T-1S15-03-X	T-1S15-03-X
-03	0.065 [1.65]	T-1S15-06-X	T-1S15-03-X	T-1S15-03-X
-04	0.150 [3.81]	T-1S15-03-X	T-1S15-03-X	T-1S15-03-X

- NOTES:
1. Ⓞ REPRESENTS A CRITICAL DIMENSION.
 2. PARTS MAY BE CUT TO POSITION.
 3. SHEAR TAILS TO DIMENSION SHOWN.
 4. MEASURED AT BEND RADIUS, NOT AT END OF PIN.
 5. GOLD PLATING TO BE ON POST, TIN PLATING TO BE ON TAIL.
 6. 4 POSITIONS PER ROW WILL BE COVERED BY SHROUDS. (2 POSITIONS PER ROW ON EACH END).
 7. 4 POSITIONS MUST BE ADDED TO PART CALLOUT TO ALLOW FOR SHROUDS, EXAMPLE FTS-125-02-L-D-SA REQUIRES A 29 POSITION BODY.
 8. NOTE DELETED.
 9. MINIMUM PUSHOUT FORCE: .5 LB (8 OZ)
 10. MAXIMUM CUT FLASH: .015[0.38]
 11. PPP-25-NT MUST BE USED FOR ALL TAPE AND REEL PACKAGING.
 12. FILL BODY SO THAT THE LEAD IN OF THE CORE IS ON THE TAILS SIDE.
 13. MAXIMUM BURR ALLOWANCE: .003[0.08]
 14. POSITIONS -05 THRU -50 TO BE TUBED. POSITIONS -02 THRU -04 ON TAIL OPTION -D TO BE LAYER PACKAGED. POSITIONS -02 THRU -04 ON TAIL OPTION -DV TO BE TAPE AND REELED.
 15. MAX HEIGHT VARIATION BETWEEN ROWS: .005[0.13].
 16. FOR QUANTITIES LESS THAN 125 PIECES, NO REEL WILL BE SUPPLIED.

FIG 1
FTS-1XX-0T-XX-D SHOWN

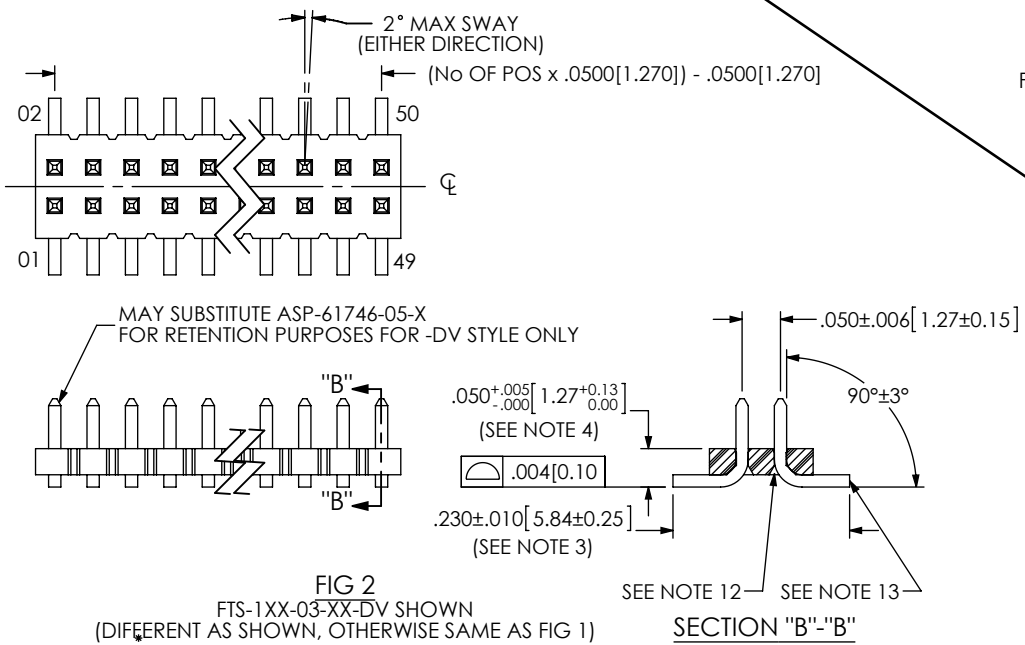

UNLESS OTHERWISE SPECIFIED, DIMENSIONS ARE IN INCHES. TOLERANCES ARE:

DECIMALS	ANGLES
.XX: ±.01 [.3]	2°
.XXX: ±.005 [.13]	
.XXXX: ±.0020 [.051]	

PROPRIETARY NOTE

THIS DOCUMENT CONTAINS INFORMATION CONFIDENTIAL AND PROPRIETARY TO SAMTEC, INC. AND SHALL NOT BE REPRODUCED OR TRANSFERRED TO OTHER DOCUMENTS OR DISCLOSED TO OTHERS OR USED FOR ANY PURPOSE OTHER THAN THAT WHICH IT WAS OBTAINED WITHOUT THE EXPRESSED WRITTEN CONSENT OF SAMTEC, INC.

520 PARK EAST BLVD. NEW ALBANY, IN 47150
PHONE: 812-944-6733 FAX: 812-948-5047
e-Mail: info@SAMTEC.com code 55322

MATERIAL: DO NOT SCALE DRAWING SHEET SCALE: 4:1
INSULATOR: LCP, UL 94 V0, COLOR: BLACK
TERMINAL: PHOS BRONZE

DESCRIPTION: .050 X .050 C.I. LOW PROFILE TERMINAL STRIP ASSEMBLY

DWG. NO. FTS-1XX-XX-XX-XX-XX

BY: BRATCHER 11/29/1993 SHEET 1 OF 4

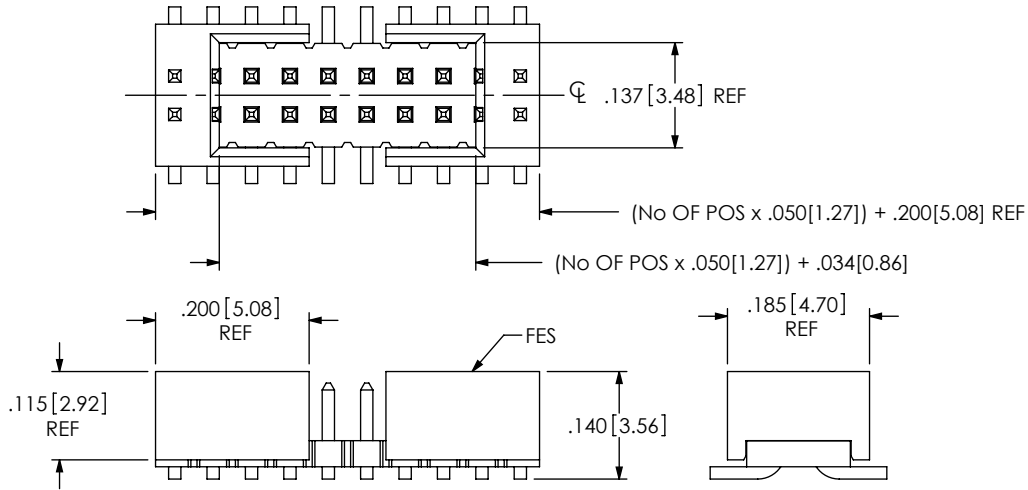

FIG 3
 -DV-S OPTION (SEE NOTES 6 & 7)
 FTS-110-02-XX-DV-S SHOWN
 (DIFFERENT AS SHOWN, OTHERWISE SAME AS FIG 1)
 NOTE: 4 POSITIONS MUST BE ADDED TO PART CALLOUT TO ACHIEVE DIMS
 (NOT AVAILABLE WITH -A OPTION; ORDER -SA FOR ALIGNMENT PIN WITH SHROUD)

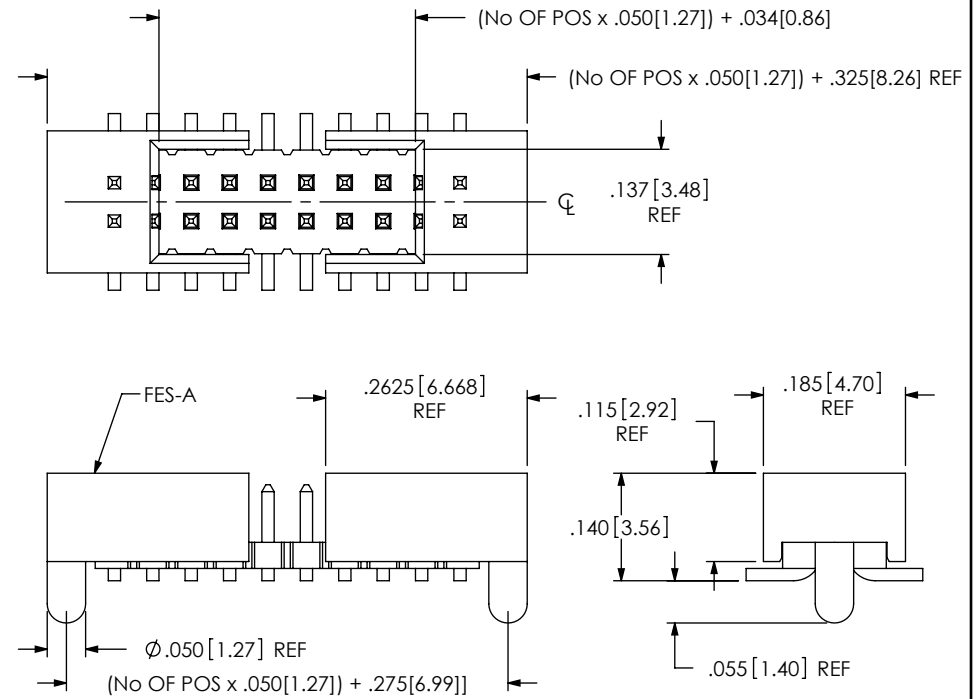
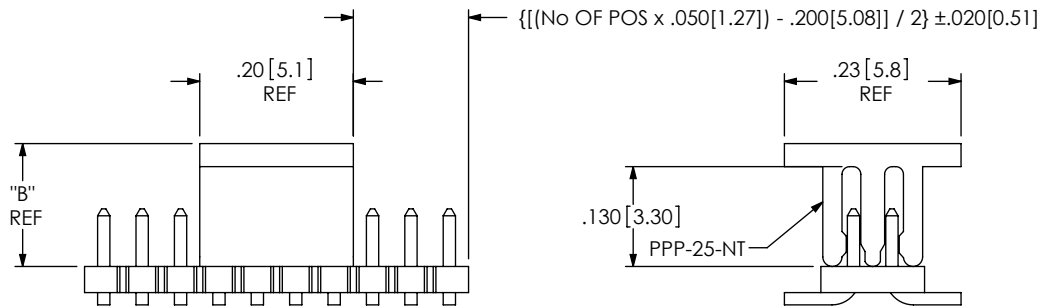

FIG 4
 -DV-SA OPTION (SEE NOTES 6 & 7)
 FTS-106-02-XX-DV-SA SHOWN
 (DIFFERENT AS SHOWN, OTHERWISE SAME AS FIG 1)
 NOTE: 4 POSITIONS MUST BE ADDED TO PART CALLOUT TO ACHIEVE DIMS

TABLE 3	
LEAD STYLE	"B"
-01, 02, 03	0.160 #####
-04	0.180 #####



(USE PPP-25-NT FOR TAPE AND REEL PACKAGING ONLY)

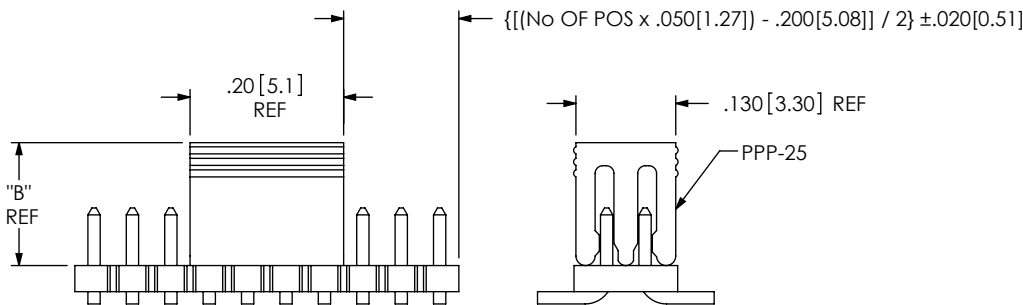

FIG 5
 -DV-P OPTION
 FTS-110-02-XX-DV-P SHOWN
 (DIFFERENT AS SHOWN, OTHERWISE SAME AS FIG 1)

F:\DWG\MISC\MKTG\FTS-1XX-XX-XX-XX-MKT.SLDDRW

PROPRIETARY NOTE
 THIS DOCUMENT CONTAINS INFORMATION
 CONFIDENTIAL AND PROPRIETARY TO
 SAMTEC, INC. AND SHALL NOT BE REPRODUCED
 OR TRANSFERRED TO OTHER DOCUMENTS OR
 DISCLOSED TO OTHERS OR USED FOR ANY
 PURPOSE OTHER THAN THAT WHICH IT WAS
 OBTAINED WITHOUT THE EXPRESSED WRITTEN
 CONSENT OF SAMTEC, INC.

DO NOT SCALE DRAWING

SHEET SCALE: 4:1

samtec

520 PARK EAST BLVD, NEW ALBANY, IN 47150
 PHONE: 812-944-6733 FAX: 812-948-5047
 e-Mail: info@SAMTEC.com code 55322

DESCRIPTION: .050 X .050 C.L. LOW PROFILE
 TERMINAL STRIP ASSEMBLY

DWG. NO. **FTS-1XX-XX-XX-XX-XX**

BY: BRATCHER 11/29/1993 SHEET 2 OF 4

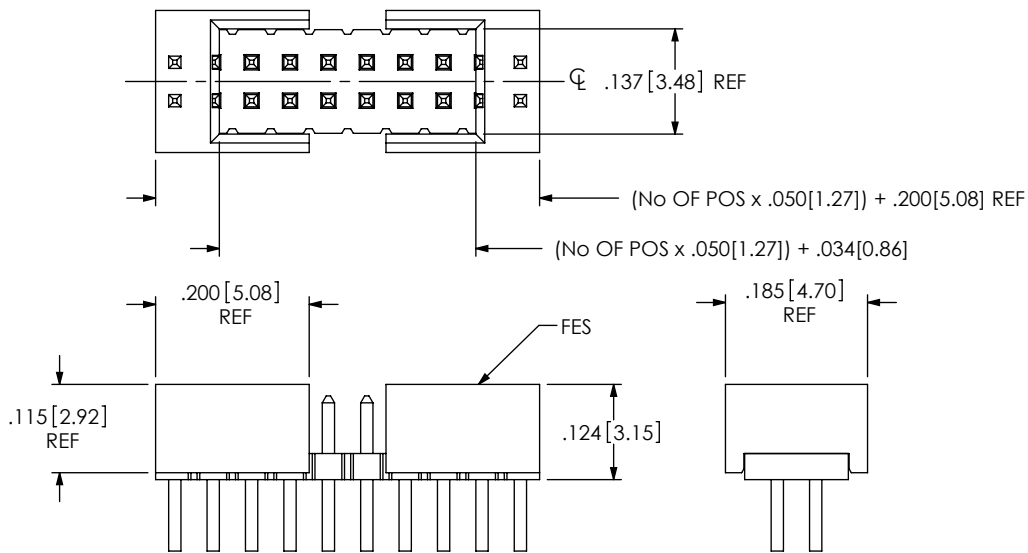

FIG 6

-D-S OPTION (SEE NOTES 6 & 7)
 FTS-110-02-XX-D-S SHOWN

(DIFFERENT AS SHOWN, OTHERWISE SAME AS FIG 1)

NOTE: 4 POSITIONS MUST BE ADDED TO PART CALLOUT TO ACHIEVE DIMS
 (NOT AVAILABLE WITH -A OPTION; ORDER -SA FOR ALIGNMENT PIN WITH SHROUD)

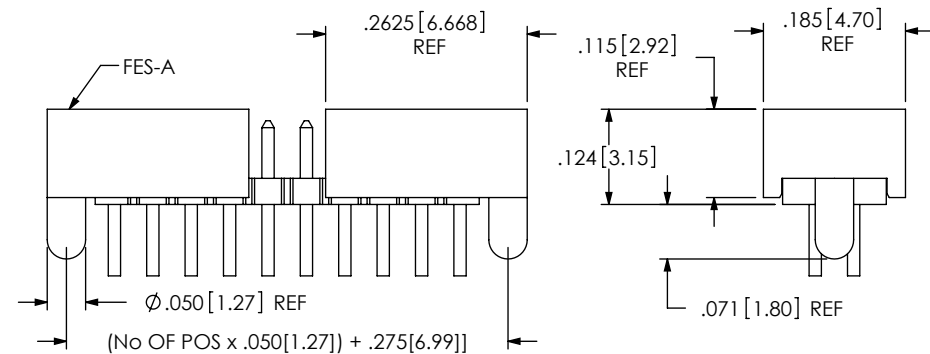
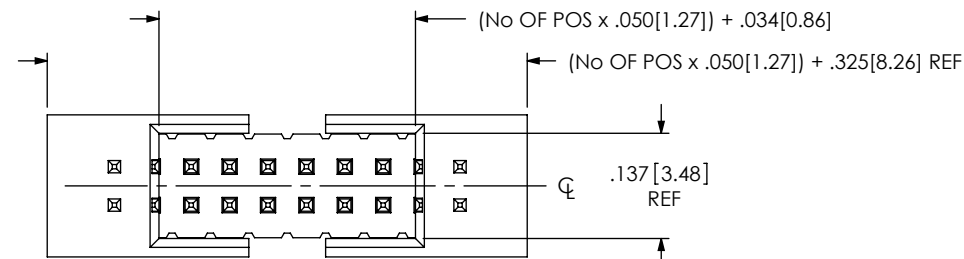

FIG 8

-D-SA OPTION (SEE NOTES 6 & 7)
 FTS-110-02-XX-D-SA SHOWN

(DIFFERENT AS SHOWN, OTHERWISE SAME AS FIG 1)

NOTE: 4 POSITIONS MUST BE ADDED TO PART CALLOUT TO ACHIEVE DIMS

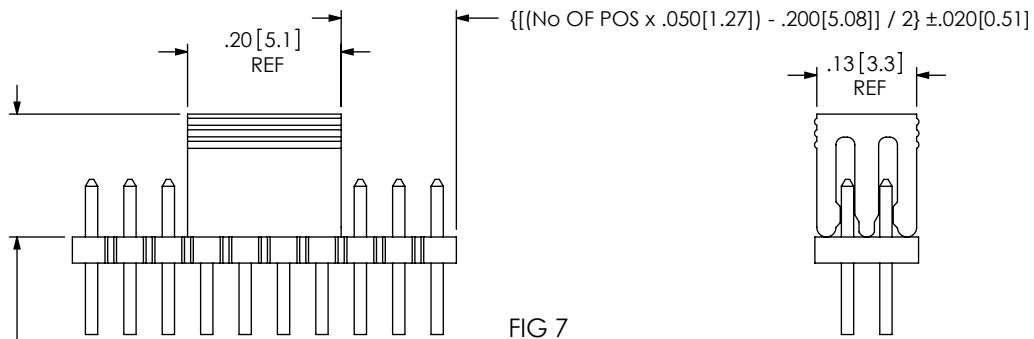

FIG 7

-D-P OPTION

FTS-110-02-XX-D-P SHOWN

(DIFFERENT AS SHOWN, OTHERWISE SAME AS FIG 1)

"B" REF
 (SEE TABLE 3, SHT 2)

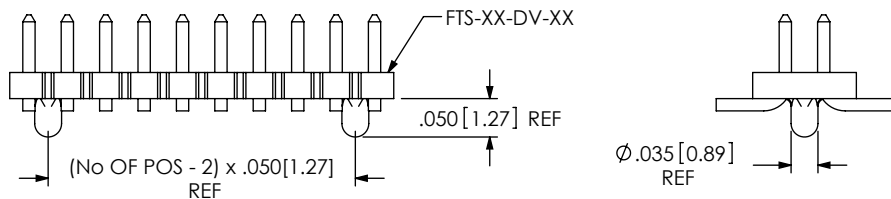

FIG 9

-A MOLDED ALIGNMENT PIN
 FTS-110-02-XX-DV-A SHOWN

(ONLY AVAILABLE IN -DV OPTION)

(DIFFERENT AS SHOWN, OTHERWISE SAME AS FIG 1)

F:\DWG\MISC\MKTG\FTS-1XX-XX-XX-XX-MKT.SLDDRW

PROPRIETARY NOTE

THIS DOCUMENT CONTAINS INFORMATION CONFIDENTIAL AND PROPRIETARY TO SAMTEC, INC. AND SHALL NOT BE REPRODUCED OR TRANSFERRED TO OTHER DOCUMENTS OR DISCLOSED TO OTHERS OR USED FOR ANY PURPOSE OTHER THAN THAT WHICH IT WAS OBTAINED WITHOUT THE EXPRESSED WRITTEN CONSENT OF SAMTEC, INC.

DO NOT SCALE DRAWING

SHEET SCALE: 4:1

samtec

520 PARK EAST BLVD, NEW ALBANY, IN 47150
 PHONE: 812-944-6733 FAX: 812-948-5047
 e-Mail: info@SAMTEC.com code 55322

DESCRIPTION: .050 X .050 C.L. LOW PROFILE TERMINAL STRIP ASSEMBLY

DWG. NO. FTS-1XX-XX-XX-XX-XX

BY: BRATCHER 11/29/1993 SHEET 3 OF 4

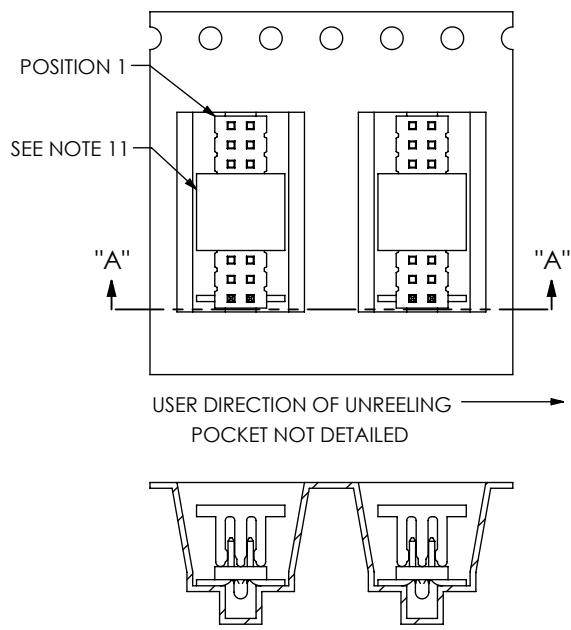

SECTION "A"-"A"

FIG 10

-TR: TAPE AND REEL PACKAGING WITH PPP-25-NT PAD
NOT AVAILABLE ON THROUGH HOLE LEAD STYLES

TABLE 2		
LEAD STYLE	PACKAGING TUBE	PLUG
-01/02/03/04-D	PT-FW001-D-.070-.198	TP-24
DV, -D-P, -DV-P, -DV-	PT-1-24-01-43	TP-24
-D-S(A)-P	PT-1-24-11-09	TP-24
-DV-S(A)-P	PT-1-24-01-09	TP-24
-D-S(A)	PT-1-24-01-37	TP-24-02
DV-S(A)	PT-1-24-02-36	TP-24-02

SEE NOTE 14

TUBE PACKAGING VIEW

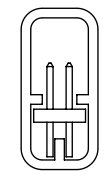

-01-D, -02-D, -03-D

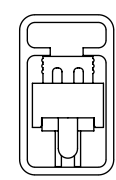

-D-S(A)-P

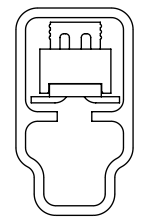

-DV-S(A)-P

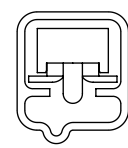

-DV-S(A)

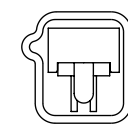

-D-S(A)

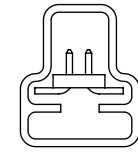

-DV

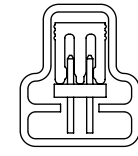

-D-P

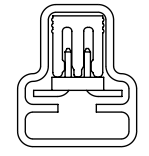

-DV-P

IN PROCESS VIEWS
(HANDFILL ONLY)

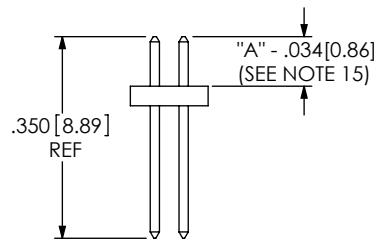

IN PROCESS 1
W/O -A PINS

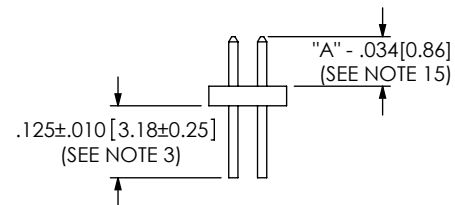

IN PROCESS 2
W/O -A PINS

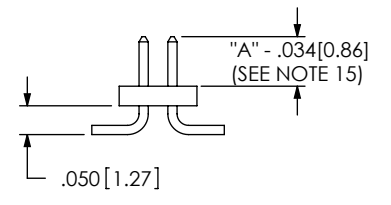

IN PROCESS 2
W/O -A PINS

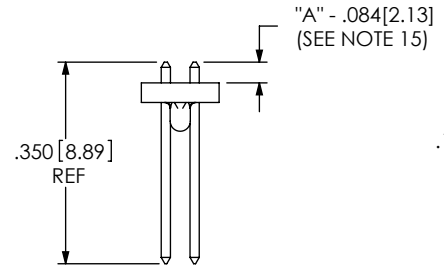

IN PROCESS 1
WITH -A PINS

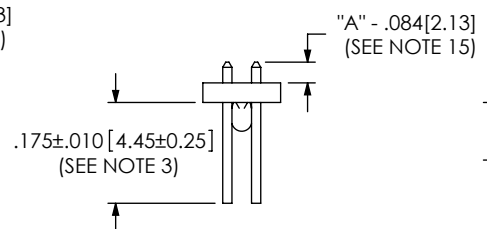

IN PROCESS 2
WITH -A PINS

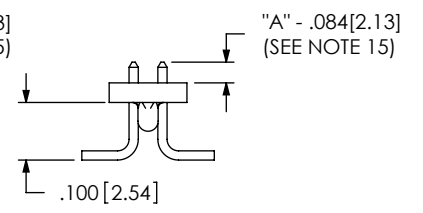

IN PROCESS 3
WITH -A PINS

PROPRIETARY NOTE
THIS DOCUMENT CONTAINS INFORMATION
CONFIDENTIAL AND PROPRIETARY TO
SAMTEC, INC. AND SHALL NOT BE REPRODUCED
OR TRANSFERRED TO OTHER DOCUMENTS OR
DISCLOSED TO OTHERS OR USED FOR ANY
PURPOSE OTHER THAN THAT WHICH IT WAS
OBTAINED WITHOUT THE EXPRESSED WRITTEN
CONSENT OF SAMTEC, INC.

DO NOT SCALE DRAWING

SHEET SCALE: 2:1



520 PARK EAST BLVD, NEW ALBANY, IN 47150
PHONE: 812-944-6733 FAX: 812-948-5047
e-Mail info@SAMTEC.com code 55322

DESCRIPTION: .050 X .050 C.L. LOW PROFILE
TERMINAL STRIP ASSEMBLY

DWG. NO. FTS-1XX-XX-XX-XX-XX

BY: BRATCHER 11/29/1993 SHEET 4 OF 4

X-ON Electronics

Largest Supplier of Electrical and Electronic Components

Click to view similar products for [samtec](#) manufacturer:

Other Similar products are found below :

[TW-10-08-H-D-616-107](#) [SSM-105-H-DV-A-P-TR](#) [ERCD-060-19.00-TEU-TBL-1-3](#) [ACD-185680-02](#) [ESQT-135-03-F-D-380](#) [FTSH-111-01-L-DV](#) [QTE-060-01-L-D-A](#) [MSAS-179-ZUGG-18](#) [MTMM-142-05-H-D-126](#) [MTSW-103-07-F-S-240](#) [MTSW-125-24-H-D-285](#) [ERF8-020-05.0-S-DV-K-TR](#) [IDMD-10-T-12.00-A-G-R](#) [IPL1-112-01-L-D-K](#) [SFM-107-02-S-D-LC](#) [SFML-115-01-S-D](#) [SFML-125-01-S-D](#) [LSHM-120-02.5-L-DV-A-N-K-TR](#) [ESQ-110-14-G-D](#) [ESQT-125-03-F-D-310](#) [ESQT-133-03-F-D-350](#) [SO-0515-01-01-02](#) [SQW-120-01-F-D-VS-A](#) [FJH-50-D-12.00-4](#) [CES-150-01-T-D](#) [QFS-052-01-SL-D-RA](#) [QTE-040-04-L-D-A](#) [QTH-020-04-F-D-DP-A-K-TR](#) [QTH-060-01-F-D-A](#) [QTH-090-04-L-D-A](#) [TCSD-10-S-05.00-01-F-N](#) [TFM-110-02-S-D](#) [TFM-115-02-L-DH](#) [TFM-120-12-S-D-LC](#) [TFML-140-02-S-D](#) [TLW-107-05-G-D](#) [BDL-136-T-E](#) [TSS-132-01-G-S](#) [TST-113-04-S-D-RA](#) [TSW-105-14-F-D](#) [BSE-040-01-F-D-A](#) [HPF-03-02-T-S](#) [IPD1-04-D-K](#) [TW-03-06-H-D-400-SM-A](#) [RPCU-G-00.50-BMS-AM](#) [ERF8-020-01-L-D-RA-L-TR](#) [ERF8-025-05.0-L-DV-TR](#) [ERF8-040-05.0-L-DV-TR](#) [SL-120-T-10](#) [SLM-115-01-S-D](#)