

Selection diagram

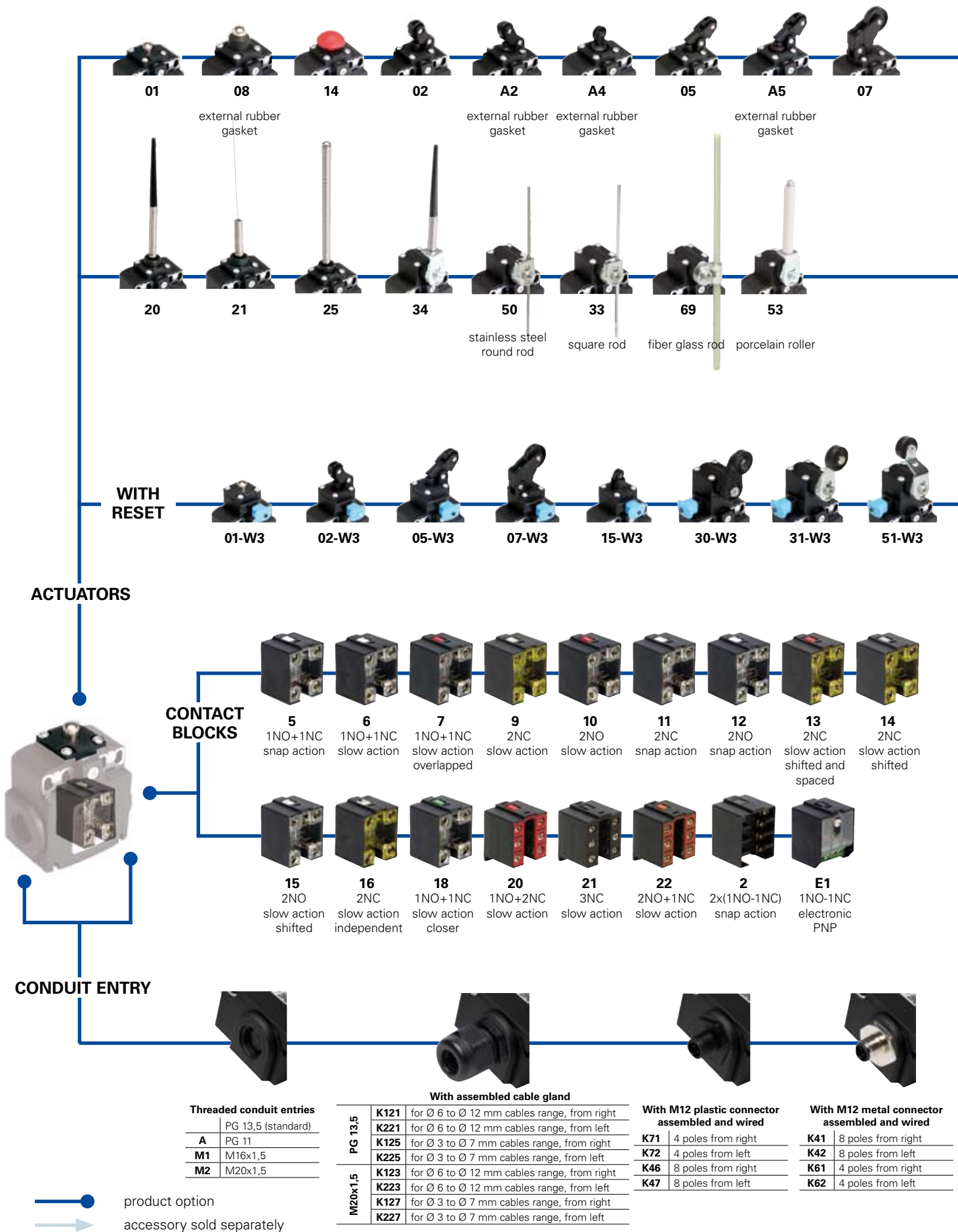

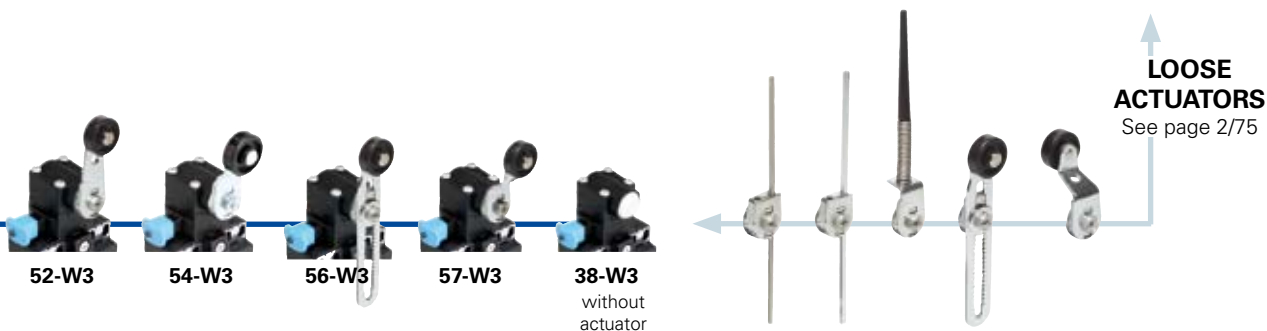
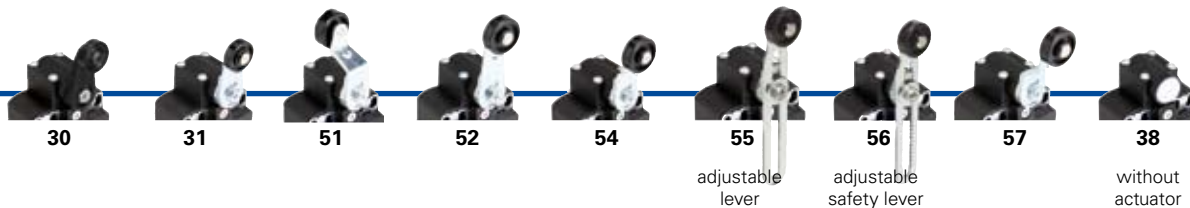
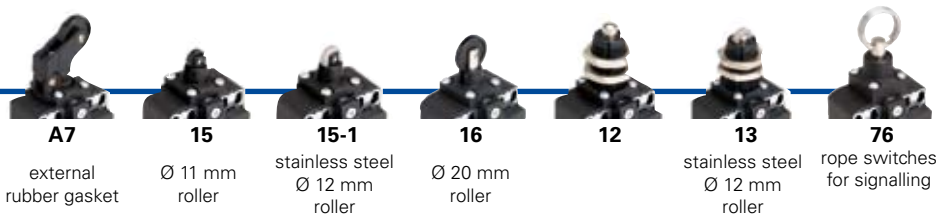

Code structure

Attention! The feasibility of a code number does not mean the effective availability of a product. Please contact our sales office.

article options
FX 502-1W3XGM2K71

Housing

FX polymer housing, two conduit entries

Contact blocks

- 5** 1NO+1NC, snap action
- 6** 1NO+1NC, slow action
- 7** 1NO+1NC, slow action overlapped
- ...

Actuators

- 01** short plunger
- 02** roller lever
- 05** offset roller lever
- ...

Suffix

- no suffix (standard)
- 1** with stainless steel roller:
 - Ø 12 mm for actuators A4, 15
 - Ø 14 mm for actuators A2, 02, A5, 05
 - Ø 20 mm for actuators 30, 31, 51, 52, 54, 55, 56, 57
- 2** with Ø 35 mm polymer roller (see special loose actuators on page 2/76)
- 3** with Ø 50 mm rubber roller (see special loose actuators on page 2/76)
- 4** with Ø 50 mm overhanging rubber roller (see special loose actuators on page 2/76)

Preinstalled cable gland or connectors

- no cable gland or connector (standard)
- K121** with right assembled cable gland suitable for Ø 6 to Ø 12 mm cables range
- ...
- K71** with 4 poles M12 plastic connector
- ...

For the complete list of all combinations, please contact our technical office.

Threaded conduit entry

- PG 13,5 (standard)
- A** PG 11
- M1** M16x1,5
- M2** M20x1,5

Contacts type

- silver contacts (standard)
- G** silver contacts gold plated 1 µm (contact block 2 excluded)

External metallic parts

- zinc plated steel (standard)
- X** stainless steel

Reset hooking

- without reset (standard)
- W3** simultaneous reset hooking



Main data

- Polymer housing, two conduit entries
- Protection degree IP67
- 17 contact blocks available
- 43 actuators available
- External stainless steel parts versions
- M12 assembled connector versions
- Silver contacts gold plated versions

Technical data

Housing

Made of glass-reinforced polymer, self-extinguishing, shock-proof thermoplastic resin and with double insulation □

Two knock out threaded conduit entries

Protection degree: IP67 according to EN 60529

General data

Ambient temperature: from -25°C to +80°C

Version for operation in ambient temperature from -40°C to +80° C on request

Max actuation frequency: 3600 operations cycles/hour

Mechanical endurance: 20 million operations cycles¹

Assembling position: any

Driving torque for installation: see pages 7/1-7/10

(1) One operation cycle means two movements, one to close and one to open contacts, as foreseen by EN 60947-5-1 standard.

Cross section of the conductors (flexible copper wire)

Contact blocks 20, 21, 22, 33, 34: min. 1 x 0,34 mm² (1 x AWG 22)

max. 2 x 1,5 mm² (2 x AWG 16)

Contact blocks 5, 6, 7, 9, 10, 11, 12, 13, 14, 15, 16, 18: min. 1 x 0,5 mm² (1 x AWG 20)

max. 2 x 2,5 mm² (2 x AWG 14)

Contact block 2: min. 1 x 0,5 mm² (1 x AWG 20)

max. 2 x 1,5 mm² (2 x AWG 16)

In conformity with standards:

IEC 60947-5-1, EN 60947-5-1, EN 60947-1, IEC 60204-1, EN 60204-1, EN 1088, EN ISO 12100-1, EN ISO 12100-2, IEC 60529, EN 60529, NFC 63-140, VDE 0660-200, VDE 0113.

Approvals:

IEC 60947-5-1, UL 508, GB14048.5-2001.

Markings and quality marks:



Approval IMQ: EG610
 Approval UL: E131787
 Approval CCC: 2007010305230013
 Approval ECU: 1010151

In conformity with requirements requested by:

Low Voltage Directive 2006/95/EC, Machinery Directive 2006/42/EC and Electromagnetic Compatibility 2004/108/EC.

Positive contact opening in conformity with standards:

IEC 60947-5-1, EN 60947-5-1, VDE 0660-206.

Installation for safety applications:

Use only switches marked with the symbol ⊕. The safety circuit must always be connected with the **NC contacts** (normally closed contacts: 11-12, 21-22 or 31-32) as stated in the **standard EN 60947-5-1, encl. K, par. 2**. The switch must be actuated with **at least up to the positive opening travel** shown in the travels diagrams on page 7/6. The switch must be actuated **at least with the positive opening force**, shown in brackets, underneath each article, near the value of the min. force.

⚠ **If not expressly indicated in this chapter, for the right installation and the correct utilization of all articles see requirements indicated from page 7/1 to page 7/10.**

	Electrical data	Utilization categories
without connector	Thermal current (I _{th}):	10 A
	Rated insulation voltage (U _i):	500 Vac 600 Vdc
	Rated impulse withstand voltage (U _{imp}):	400Vac500Vdc(contact blocks 2, 11, 12, 20, 21, 22, 33, 34)
		6 kV
		4 kV (contact blocks 20, 21, 22, 33, 34)
with 4 poles M12 connector	Thermal current (I _{th}):	4 A
	Rated insulation voltage (U _i):	250 Vac 300 Vdc
	Protection against short circuits:	fuse 4 A 500 V type gG
	Pollution degree:	3
with 8 poles M12 connector	Thermal current (I _{th}):	2 A
	Rated insulation voltage (U _i):	30 Vac 36 Vdc
	Protection against short circuits:	fuse 2 A 500 V type gG
	Pollution degree:	3
		Alternate current: AC15 (50...60 Hz)
		U _e (V) 250 400 500
		I _e (A) 6 4 1
		Direct current: DC13
		U _e (V) 24 125 250
		I _e (A) 6 1,1 0,4
		Alternate current: AC15 (50...60 Hz)
		U _e (V) 24 120 250
		I _e (A) 4 4 4
		Direct current: DC13
		U _e (V) 24 125 250
		I _e (A) 4 1,1 0,4
		Alternate current: AC15 (50...60 Hz)
		U _e (V) 24
		I _e (A) 2
		Direct current: DC13
		U _e (V) 24
		I _e (A) 2



Data type approved by IMQ, CCC and EZU

Rated insulation voltage (Ui): 500 Vac
400 Vac (for contact blocks 2, 11, 12, 20, 21, 22, 33, 34)

Thermal current (Ith): 10 A

Protection against short circuits: fuse 10 A 500 V type aM

Rated impulse withstand voltage (U_{imp}): 6 kV
4 kV (for contact blocks 20, 21, 22, 33, 34)

Protection degree: IP67

MV terminals (screw clamps)

Pollution degree 3

Utilization category: AC15

Operation voltage (Ue): 400 Vac (50 Hz)

Operation current (Ie): 3 A

Forms of the contact element: Za, Zb, Za+Za, Y+Y, X+X, Y+Y+X, Y+Y+Y, Y+X+X

Positive opening of contacts on contact block 5, 6, 7, 9, 11, 13, 14, 16, 18, 20, 21, 22, 33, 34

In conformity with standards: EN 60947-1, EN 60947-5-1+ A1:2009, fundamental requirements of the Low Voltage Directive 2006/95/CE.

Please contact our technical service for the list of approved products.

Data type approved by UL

Utilization categories Q300 (69 VA, 125-250 Vdc)
A600 (720 VA, 120-600 Vac)

Data of the housing type 1, 4X "indoor use only"; 12, 13

For all contact blocks except 2 and 3 use 60 or 75 °C copper (Cu) conductor and wire size No. 12-14 AWG. Terminal tightening torque of 7,1 lb in (0,8 Nm).
For contact blocks 2 and 3 use 60 or 75 °C copper (Cu) conductor and wire size No. 14 AWG. Terminal tightening torque of 12 lb in (1,4 Nm).

In conformity with standard: UL 508

Please contact our technical service for the list of approved products.

Adjustable levers

In switches with revolving lever it is possible to adjust the lever with 10° steps for the whole 360° range. The positive movement

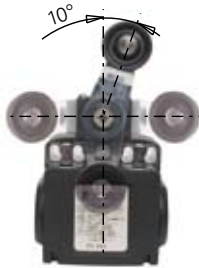

transmission is always guaranteed thanks to the particular geometrical coupling between the lever and the revolving shaft as prescribed for safety applications by the German standard BG-GS-ET-15.

Overturning levers

It's possible to fasten the lever on switches on straight or reverse side, maintaining the positive coupling.

In this way it is possible to obtain two different work plans of the lever.



Rotating heads

In all switches, it is possible to rotate the head in 90° steps.



Working operation of contact block 16 with independent contacts

The contact block 16 has two NC contacts, both with positive opening activated independently according to the lever turning direction.

Lever turned to left

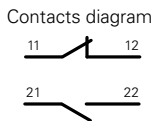

Lever not turned

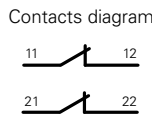

Lever turned to right

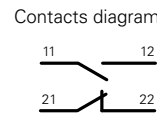

Position switches FX series

Contacts type:

- R** = snap action
- L** = slow action
- LO** = slow action overlapped
- LS** = slow action shifted
- LV** = slow action shifted and spaced
- LI** = slow action independent
- LA** = slow action closer
- ⏏** = electronic PNP

Contact blocks

		With stainless steel roller on request	With external rubber gasket With stainless steel roller on request	With external rubber gasket With Ø 12 mm stainless steel roller on request
5	R FX 501	⊕ 1NO+1NC	⊕ 1NO+1NC	⊕ 1NO+1NC
6	L FX 601	⊕ 1NO+1NC	⊕ 1NO+1NC	⊕ 1NO+1NC
7	LO FX 701	⊕ 1NO+1NC	⊕ 1NO+1NC	⊕ 1NO+1NC
9	L FX 901	⊕ 2NC	⊕ 2NC	⊕ 2NC
10	L FX 1001	2NO	2NO	2NO
11	R FX 1101	⊕ 2NC	⊕ 2NC	⊕ 2NC
12	R FX 1201	2NO	2NO	2NO
13	LV FX 1301	⊕ 2NC	⊕ 2NC	⊕ 2NC
14	LS FX 1401	⊕ 2NC	⊕ 2NC	⊕ 2NC
15	LS FX 1501	2NO	2NO	2NO
18	LA FX 1801	⊕ 1NO+1NC	⊕ 1NO+1NC	⊕ 1NO+1NC
20	L FX 2001	⊕ 1NO+2NC	⊕ 1NO+2NC	⊕ 1NO+2NC
21	L FX 2101	⊕ 3NC	⊕ 3NC	⊕ 3NC
22	L FX 2201	⊕ 2NO+1NC	⊕ 2NO+1NC	⊕ 2NO+1NC
2	R FX 201	2x(1NO-1NC)	2x(1NO-1NC)	2x(1NO-1NC)
E1	⏏ FX E101	1NO-1NC	1NO-1NC	1NO-1NC
Max speed		page 7/5 - type 4	page 7/5 - type 3	page 7/5 - type 3
Min. force		8 N (25 N ⊕)	6 N (25 N ⊕)	4,3 N (25 N ⊕)
Travel diagrams		page 7/6 - group 1	page 7/6 - group 2	page 7/6 - group 2

	With stainless steel roller on request	With external rubber gasket With stainless steel roller on request	With external rubber gasket	With external rubber gasket
5	R FX 505	⊕ 1NO+1NC	⊕ 1NO+1NC	⊕ 1NO+1NC
6	L FX 605	⊕ 1NO+1NC	⊕ 1NO+1NC	⊕ 1NO+1NC
7	LO FX 705	⊕ 1NO+1NC	⊕ 1NO+1NC	⊕ 1NO+1NC
9	L FX 905	⊕ 2NC	⊕ 2NC	⊕ 2NC
10	L FX 1005	2NO	2NO	2NO
11	R FX 1105	⊕ 2NC	⊕ 2NC	⊕ 2NC
12	R FX 1205	2NO	2NO	2NO
13	LV FX 1305	⊕ 2NC	⊕ 2NC	⊕ 2NC
14	LS FX 1405	⊕ 2NC	⊕ 2NC	⊕ 2NC
15	LS FX 1505	2NO	2NO	2NO
18	LA FX 1805	⊕ 1S+1Ö	⊕ 1S+1Ö	⊕ 1NO+1NC
20	L FX 2005	⊕ 1NO+2NC	⊕ 1NO+2NC	⊕ 1NO+2NC
21	L FX 2105	⊕ 3NC	⊕ 3NC	⊕ 3NC
22	L FX 2205	⊕ 2NO+1NC	⊕ 2NO+1NC	⊕ 2NO+1NC
2	R FX 205	2x(1NO-1NC)	2x(1NO-1NC)	2x(1NO-1NC)
E1	⏏ FX E105	1NO-1NC	1NO-1NC	1NO-1NC
Max speed		page 7/5 - type 3	page 7/5 - type 3	page 7/5 - type 3
Min. force		6 N (25 N ⊕)	4,3 N (25 N ⊕)	3 N (25 N ⊕)
Travel diagrams		page 7/6 - group 2	page 7/6 - group 2	page 7/6 - group 3

Accessories See page 6/1

All measures in the drawings are in mm



Contacts type:

- R** = snap action
- L** = slow action
- LO** = slow action overlapped
- LS** = slow action shifted
- LV** = slow action shifted and spaced
- LI** = slow action independent
- LA** = slow action closer
- △** = electronic PNP

Contact blocks

With external rubber gasket

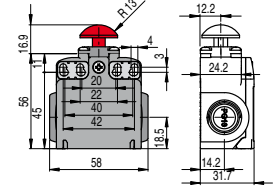
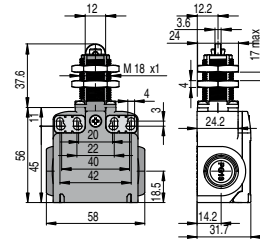
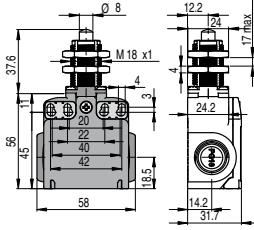
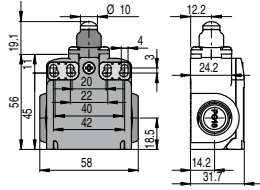

5	R	FX 508	➔ 1NO+1NC	FX 512	➔ 1NO+1NC	FX 513	➔ 1NO+1NC	FX 514	➔ 1NO+1NC
6	L	FX 608	➔ 1NO+1NC	FX 612	➔ 1NO+1NC	FX 613	➔ 1NO+1NC	FX 614	➔ 1NO+1NC
7	LO	FX 708	➔ 1NO+1NC	FX 712	➔ 1NO+1NC	FX 713	➔ 1NO+1NC	FX 714	➔ 1NO+1NC
9	L	FX 908	➔ 2NC	FX 912	➔ 2NC	FX 913	➔ 2NC	FX 914	➔ 2NC
10	L	FX 1008	2NO	FX 1012	2NO	FX 1013	2NO	FX 1014	2NO
11	R	FX 1108	➔ 2NC	FX 1112	➔ 2NC	FX 1113	➔ 2NC	FX 1114	➔ 2NC
12	R	FX 1208	2NO	FX 1212	2NO	FX 1213	2NO	FX 1214	2NO
13	LV	FX 1308	➔ 2NC	FX 1312	➔ 2NC	FX 1313	➔ 2NC	FX 1314	➔ 2NC
14	LS	FX 1408	➔ 2NC	FX 1412	➔ 2NC	FX 1413	➔ 2NC	FX 1414	➔ 2NC
15	LS	FX 1508	2NO	FX 1512	2NO	FX 1513	2NO	FX 1514	2NO
18	LA	FX 1808	➔ 1NO+1NC	FX 1812	➔ 1S+1Ö	FX 1813	➔ 1S+1Ö	FX 1814	➔ 1S+1Ö
20	L	FX 2008	➔ 1NO+2NC	FX 2012	➔ 1NO+2NC	FX 2013	➔ 1NO+2NC	FX 2014	➔ 1NO+2NC
21	L	FX 2108	➔ 3NC	FX 2112	➔ 3NC	FX 2113	➔ 3NC	FX 2114	➔ 3NC
22	L	FX 2208	➔ 2NO+1NC	FX 2212	➔ 2NO+1NC	FX 2213	➔ 2NO+1NC	FX 2214	➔ 2NO+1NC
2	R	FX 208	2x(1NO-1NC)	FX 212	2x(1NO-1NC)	FX 213	2x(1NO-1NC)	FX 214	2x(1NO-1NC)
E1	△	FX E108	1NO-1NC	FX E112	1NO-1NC	FX E113	1NO-1NC	FX E114	1NO-1NC
Max speed		page 7/5 - type 4		page 7/5 - type 4		page 7/5 - type 2		page 7/5 - type 4	
Min. force		8 N (25 N ➔)		8 N (25 N ➔)		8 N (25 N ➔)		8 N (25 N ➔)	
Travel diagrams		page 7/6 - group 1		page 7/6 - group 1		page 7/6 - group 1		page 7/6 - group 1	

Ø 11 mm polymer roller

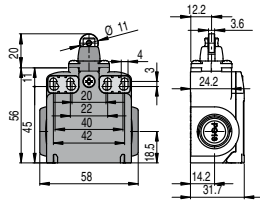

Ø 12 mm stainless steel roller

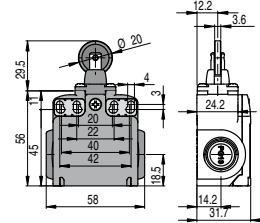
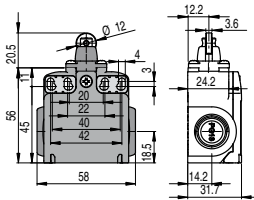

With external rubber gasket

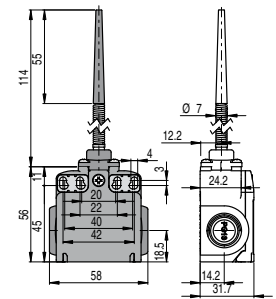

Contact blocks

5	R	FX 515	➔ 1NO+1NC	FX 515-1	➔ 1NO+1NC	FX 516	➔ 1NO+1NC	FX 520	1NO+1NC
6	L	FX 615	➔ 1NO+1NC	FX 615-1	➔ 1NO+1NC	FX 616	➔ 1NO+1NC		
7	LO	FX 715	➔ 1NO+1NC	FX 715-1	➔ 1NO+1NC	FX 716	➔ 1NO+1NC		
9	L	FX 915	➔ 2NC	FX 915-1	➔ 2NC	FX 916	➔ 2NC		
10	L	FX 1015	2NO	FX 1015-1	2NO	FX 1016	2NO	FX 1020	2NO
11	R	FX 1115	➔ 2NC	FX 1115-1	➔ 2NC	FX 1116	➔ 2NC		
12	R	FX 1215	2NO	FX 1215-1	2NO	FX 1216	2NO	FX 1220	2NO
13	LV	FX 1315	➔ 2NC	FX 1315-1	➔ 2NC	FX 1316	➔ 2NC		
14	LS	FX 1415	➔ 2NC	FX 1415-1	➔ 2NC	FX 1416	➔ 2NC		
15	LS	FX 1515	2NO	FX 1515-1	2NO	FX 1516	2NO		
18	LA	FX 1815	➔ 1S+1Ö	FX 1815-1	➔ 1S+1Ö	FX 1816	➔ 1S+1Ö	FX 1820	1NO+1NC
20	L	FX 2015	➔ 1NO+2NC	FX 2015-1	➔ 1NO+2NC	FX 2016	➔ 1NO+2NC	FX 2020	1NO+2NC
21	L	FX 2115	➔ 3NC	FX 2115-1	➔ 3NC	FX 2116	➔ 3NC	FX 2120	3NC
22	L	FX 2215	➔ 2NO+1NC	FX 2215-1	➔ 2NO+1NC	FX 2216	➔ 2NO+1NC	FX 2220	2NO+1NC
2	R	FX 215	2x(1NO-1NC)	FX 215-1	2x(1NO-1NC)	FX 216	2x(1NO-1NC)	FX 220	2x(1NO-1NC)
E1	△	FX E115	1NO-1NC	FX E115-1	1NO-1NC	FX E116	1NO-1NC	FX E120	1NO-1NC
Max speed		page 7/5 - type 2		page 7/5 - type 2		page 7/5 - type 2		1 m/s	
Min. force		8 N (25 N ➔)		8 N (25 N ➔)		8 N (25 N ➔)		0,07 Nm	
Travel diagrams		page 7/6 - group 1		page 7/6 - group 1		page 7/6 - group 1		page 7/6 - group 4	

Items with code on the green background are available in stock

Contacts type:

- R** = snap action
- L** = slow action
- LO** = slow action overlapped
- LS** = slow action shifted
- LV** = slow action shifted and spaced
- LI** = slow action independent
- LA** = slow action closer
- ⏏** = electronic PNP

Contact blocks

	With external rubber gasket	With external rubber gasket	With Ø 20 mm stainless steel roller on request	Other rollers available. See page 2/76
5	R FX 521	R FX 525	R FX 530	R FX 531
6	L		L FX 630	L FX 631
7	LO		LO FX 730	LO FX 731
9	L		L FX 930	L FX 931
10	L FX 1021	L FX 1025	L FX 1030	L FX 1031
11	R		R FX 1130	R FX 1131
12	R FX 1221	R FX 1225	R FX 1230	R FX 1231
13	LV		LV FX 1330	LV FX 1331
14	LS		LS FX 1430	LS FX 1431
15	LS		LS FX 1530	LS FX 1531
16	LI		LI FX 1630	LI FX 1631
18	LA FX 1821	LA FX 1825	LA FX 1830	LA FX 1831
20	L FX 2021	L FX 2025	L FX 2030	L FX 2031
21	L FX 2121	L FX 2125	L FX 2130	L FX 2131
22	L FX 2221	L FX 2225	L FX 2230	L FX 2231
2	R FX 221	R FX 225	R FX 230	R FX 231
E1	⏏ FX E121	⏏ FX E125	⏏ FX E130	⏏ FX E131
Max speed	1 m/s	1 m/s	page 7/5 - type 1	page 7/5 - type 1
Min. force	0,07 Nm	0,12 Nm	0,06 Nm (0,25 Nm ⊕)	0,06 Nm (0,25 Nm ⊕)
Travel diagrams	page 7/6 - group 4	page 7/6 - group 4	page 7/6 - group 5	page 7/6 - group 5

	3x3 mm square rod	Ø 3 mm stainless steel round rod	Other rollers available. See page 2/76
5	R FX 533	R FX 534	R FX 551
6	L FX 633	L FX 634	L FX 651
7	LO FX 733	LO FX 734	LO FX 751
9	L FX 933	L FX 934	L FX 951
10	L FX 1033	L FX 1034	L FX 1051
11	R FX 1133	R FX 1134	R FX 1151
12	R FX 1233	R FX 1234	R FX 1251
13	LV FX 1333	LV FX 1334	LV FX 1351
14	LS FX 1433	LS FX 1434	LS FX 1451
15	LS FX 1533	LS FX 1534	LS FX 1551
16	LI FX 1633	LI FX 1634	LI FX 1651
18	LA FX 1833	LA FX 1834	LA FX 1851
20	L FX 2033	L FX 2034	L FX 2051
21	L FX 2133	L FX 2134	L FX 2151
22	L FX 2233	L FX 2234	L FX 2251
2	R FX 233	R FX 234	R FX 251
E1	⏏ FX E133	⏏ FX E134	⏏ FX E151
Max speed	1,5 m/s	1,5 m/s	page 7/5 - type 1
Min. force	0,06 Nm	0,06 Nm	0,06 Nm (0,25 Nm ⊕)
Travel diagrams	page 7/6 - group 5	page 7/6 - group 5	page 7/6 - group 5

Accessories See page 6/1



Contacts type:

- R** = snap action
- L** = slow action
- LO** = slow action overlapped
- LS** = slow action shifted
- LV** = slow action shifted and spaced
- LI** = slow action independent
- LA** = slow action closer
- ⚡** = electronic PNP

Contact blocks

Other rollers available. See page 2/76

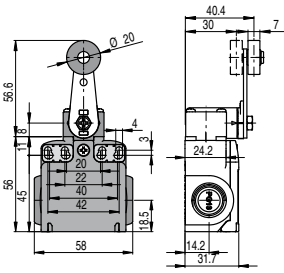

Porcelain roller

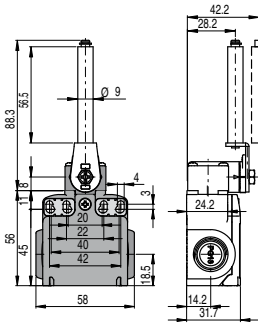

Other rollers available. See page 2/76

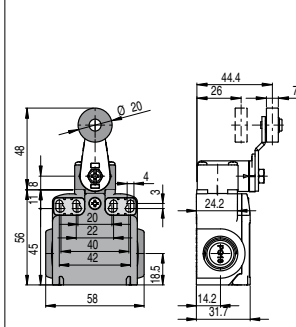

Other rollers available. See page 2/76

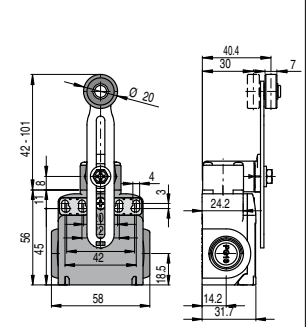

5	R	FX 552	➔	1NO+1NC	FX 553-E0V9	➔	1NO+1NC	FX 554	➔	1NO+1NC	FX 555	➔ (1)	1NO+1NC
6	L	FX 652	➔	1NO+1NC	FX 653-E0V9	➔	1NO+1NC	FX 654	➔	1NO+1NC	FX 655	➔ (1)	1NO+1NC
7	LO	FX 752	➔	1NO+1NC	FX 753-E0V9	➔	1NO+1NC	FX 754	➔	1NO+1NC	FX 755	➔ (1)	1NO+1NC
9	L	FX 952	➔	2NC	FX 953-E0V9	➔	2NC	FX 954	➔	2NC	FX 955	➔ (1)	2NC
10	L	FX 1052		2NO	FX 1053-E0V9		2NO	FX 1054		2NO	FX 1055		2NO
11	R	FX 1152	➔	2NC	FX 1253-E0V9		2NO	FX 1154	➔	2NC	FX 1155	➔ (1)	2NC
12	R	FX 1252		2NO	FX 1353-E0V9	➔	2NC	FX 1254		2NO	FX 1255		2NO
13	LV	FX 1352	➔	2NC	FX 1453-E0V9	➔	2NC	FX 1354	➔	2NC	FX 1355	➔ (1)	2NC
14	LS	FX 1452	➔	2NC	FX 1553-E0V9		2NO	FX 1454	➔	2NC	FX 1455	➔ (1)	2NC
15	LS	FX 1552		2NO	FX 1853-E0V9	➔	1S+1Ö	FX 1554		2NO	FX 1555		2NO
16	LI	FX 1652	➔	2NC	FX 2053-E0V9	➔	1NO+2NC	FX 1654	➔	2NC	FX 1655	➔ (1)	2NC
18	LA	FX 1852	➔	1S+1Ö	FX 2153-E0V9	➔	3NC	FX 1854	➔	1S+1Ö	FX 1855	➔ (1)	1S+1Ö
20	L	FX 2052	➔	1NO+2NC	FX 2253-E0V9	➔	2NO+1NC	FX 2054	➔	1NO+2NC	FX 2055	➔ (1)	1NO+2NC
21	L	FX 2152	➔	3NC	FX 253-E0		2x(1NO-1NC)	FX 2154	➔	3NC	FX 2155	➔ (1)	3NC
22	L	FX 2252	➔	2NO+1NC	FX E153-E0V9		1NO-1NC	FX 2254	➔	2NO+1NC	FX 2255	➔ (1)	2NO+1NC
2	R	FX 252		2x(1NO-1NC)	FX E154		1NO-1NC	FX 254		2x(1NO-1NC)	FX 255		2x(1NO-1NC)
E1	⚡	FX E152		1NO-1NC				FX E154		1NO-1NC	FX E155		1NO-1NC
Max speed		page 7/5 - type 1			0,5 m/s			page 7/5 - type 1			page 7/5 - type 1		
Min. force		0,06 Nm (0,25 Nm ➔)			0,03 Nm (0,25 Nm ➔)			0,06 Nm (0,25 Nm ➔)			0,06 Nm (0,25 Nm ➔)		
Travel diagrams		page 7/6 - group 5			page 7/6 - group 6			page 7/6 - group 5			page 7/6 - group 5		

Other rollers available. See page 2/76

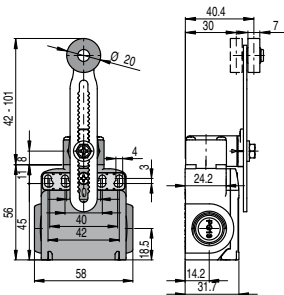

Other rollers available. See page 2/76

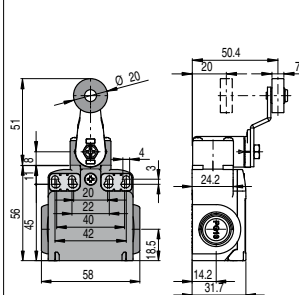

Fiber glass rod

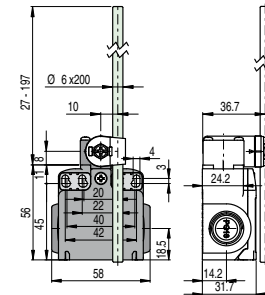

Rope switches for signalling

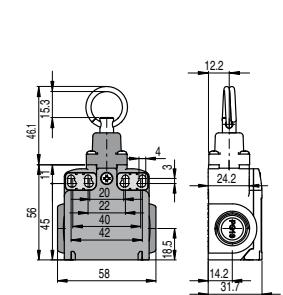

Contact blocks

5	R	FX 556	➔	1NO+1NC	FX 557	➔	1NO+1NC	FX 569		1NO+1NC	FX 576		1NO+1NC
6	L	FX 656	➔	1NO+1NC	FX 657	➔	1NO+1NC	FX 669		1NO+1NC	FX 676		1NO+1NC
7	LO	FX 756	➔	1NO+1NC	FX 757	➔	1NO+1NC	FX 769		1NO+1NC	FX 776		1NO+1NC
9	L	FX 956	➔	2NC	FX 957	➔	2NC	FX 969		2NC	FX 976		2NO
10	L	FX 1056		2NO	FX 1057		2NO	FX 1069		2NO	FX 1076		2NC
11	R	FX 1156	➔	2NC	FX 1157	➔	2NC	FX 1169		2NC	FX 1176		2NO
12	R	FX 1256		2NO	FX 1257		2NO	FX 1269		2NO	FX 1276		2NC
13	LV	FX 1356	➔	2NC	FX 1357	➔	2NC	FX 1369		2NC	FX 1376		2NO
14	LS	FX 1456	➔	2NC	FX 1457	➔	2NC	FX 1469		2NC	FX 1476		2NO
15	LS	FX 1556		2NO	FX 1557		2NO	FX 1569		2NO	FX 1576		2NC
16	LI	FX 1656	➔	2NC	FX 1657	➔	2NC	FX 1669		2NC			
18	LA	FX 1856	➔	1S+1Ö	FX 1857	➔	1NC+1NO	FX 1869		1NC+1NO	FX 1876		1NO+1NC
20	L	FX 2056	➔	1NO+2NC	FX 2057	➔	1NO+2NC	FX 2069		1NO+2NC	FX 2076		2NO+1NC
21	L	FX 2156	➔	3NC	FX 2157	➔	3NC	FX 2169		3NC	FX 2176		3NO
22	L	FX 2256	➔	2NO+1NC	FX 2257	➔	2NO+1NC	FX 2269		2NO+1NC	FX 2276		1NO+2NC
2	R	FX 256		2x(1NO-1NC)	FX 257		2x(1NO-1NC)	FX 269		2x(1NO-1NC)	FX 276		2x(1NO-1NC)
E1	⚡	FX E156		1NO-1NC	FX E157		1NO-1NC	FX E169		1NO-1NC			
Max speed		page 7/5 - type 1			page 7/5 - type 1			1,5 m/s			0,5 m/s		
Min. force		0,06 Nm (0,25 Nm ➔)			0,06 Nm (0,25 Nm ➔)			0,06 Nm			initial 20 N - final 40 N		
Travel diagrams		page 7/6 - group 5			page 7/6 - group 5			page 7/6 - group 5			page 7/6 - group 7		

Items with code on the green background are available in stock

(1) Positive opening only with lever adjusted on the max. See page 2/75.
General Catalog 2011-2012



Position switches FX series with reset



Pizzato Eletttrica has developed a reset device code W3 to make perfectly simultaneous the actuator and the contact block tripping. The new device is a block inserted between the switch body and the head, and could be rotated independently from this last one. This new device has following advantages:

- * The reset device integrate in any standard actuation head
- * Contact blocks with snap action are no more necessary because the tripping movement is made by the reset device itself
- * The reset device can be rotated independently from the head for the maximum flexibility during the assembling.

Contacts type:

- R** = snap action
- L** = slow action

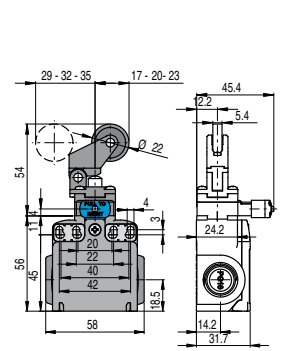
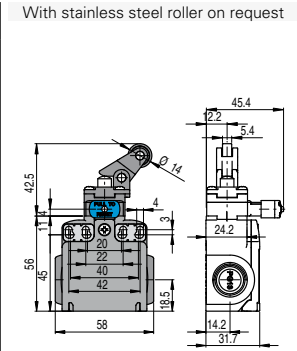
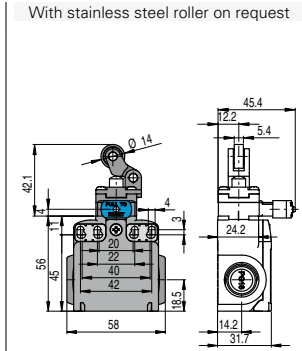
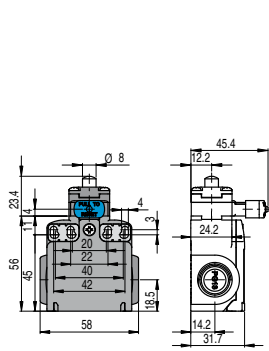

Contact blocks

6	L	FX 601-W3	⊕ 1NO+1NC	FX 602-W3	⊕ 1NO+1NC	FX 605-W3	⊕ 1NO+1NC	FX 607-W3	⊕ 1NO+1NC
9	L	FX 901-W3	⊕ 2NC	FX 902-W3	⊕ 2NC	FX 905-W3	⊕ 2NC	FX 907-W3	⊕ 2NC
10	L	FX 1001-W3	2NO	FX 1002-W3	2NO	FX 1005-W3	2NO	FX 1007-W3	2NO
20	L	FX 2001-W3	⊕ 1NO+2NC	FX 2002-W3	⊕ 1NO+2NC	FX 2005-W3	⊕ 1NO+2NC	FX 2007-W3	⊕ 1NO+2NC
21	L	FX 2101-W3	⊕ 3NC	FX 2102-W3	⊕ 3NC	FX 2105-W3	⊕ 3NC	FX 2107-W3	⊕ 3NC
22	L	FX 2201-W3	⊕ 2NO+1NC	FX 2202-W3	⊕ 2NO+1NC	FX 2205-W3	⊕ 2NO+1NC	FX 2207-W3	⊕ 2NO+1NC
2	R	FX 201-W3	2NO+2NC	FX 202-W3	2NO+2NC	FX 205-W3	2NO+2NC	FX 207-W3	2NO+2NC
Max speed		page 7/5 - type 4		page 7/5 - type 3		page 7/5 - type 3		page 7/5 - type 3	
Min. force		8 N (25 N ⊕)		6 N (25 N ⊕)		6 N (25 N ⊕)		4 N (25 N ⊕)	
Travel diagrams		page 7/7 - group 1		page 7/7 - group 2		page 7/7 - group 2		page 7/7 - group 3	

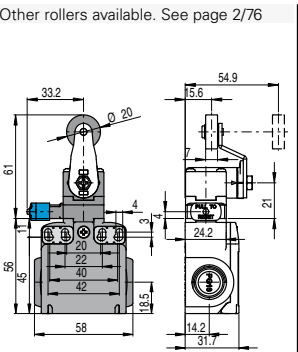
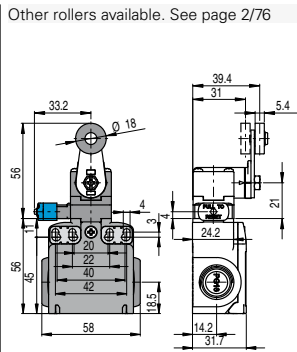
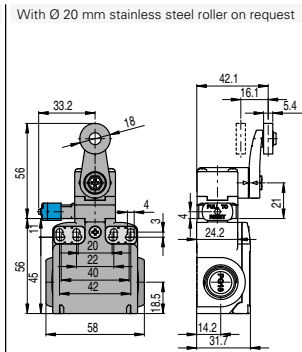
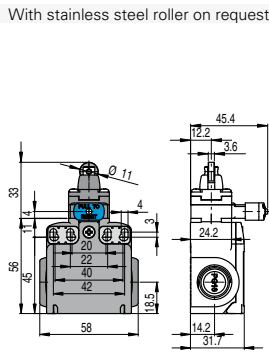

6	L	FX 615-W3	⊕ 1NO+1NC	FX 630-W3	⊕ 1NO+1NC	FX 631-W3	⊕ 1NO+1NC	FX 651-W3	⊕ 1NO+1NC
9	L	FX 915-W3	⊕ 2NC	FX 930-W3	⊕ 2NC	FX 931-W3	⊕ 2NC	FX 951-W3	⊕ 2NC
10	L	FX 1015-W3	2NO	FX 1030-W3	2NO	FX 1031-W3	2NO	FX 1051-W3	2NO
20	L	FX 2015-W3	⊕ 1NO+2NC	FX 2030-W3	⊕ 1NO+2NC	FX 2031-W3	⊕ 1NO+2NC	FX 2051-W3	⊕ 1NO+2NC
21	L	FX 2115-W3	⊕ 3NC	FX 2130-W3	⊕ 3NC	FX 2131-W3	⊕ 3NC	FX 2151-W3	⊕ 3NC
22	L	FX 2215-W3	⊕ 2NO+1NC	FX 2230-W3	⊕ 2NO+1NC	FX 2231-W3	⊕ 2NO+1NC	FX 2251-W3	⊕ 2NO+1NC
2	R	FX 215-W3	2NO+2NC	FX 230-W3	2NO+2NC	FX 231-W3	2NO+2NC	FX 251-W3	2NO+2NC
Max speed		page 7/5 - type 2		page 7/5 - type 1		page 7/5 - type 1		page 7/5 - type 1	
Min. force		8 N (25 N ⊕)		0,06 Nm (0,25 Nm ⊕)		0,06 Nm (0,25 Nm ⊕)		0,06 Nm (0,25 Nm ⊕)	
Travel diagrams		page 7/7 - group 1		page 7/7 - group 4		page 7/7 - group 4		page 7/7 - group 4	



Contacts type:

- R** = snap action
- L** = slow action

Other rollers available. See page 2/76

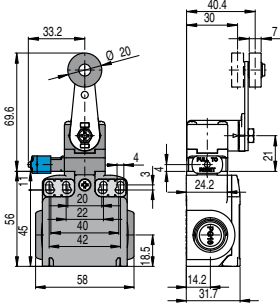

Other rollers available. See page 2/76

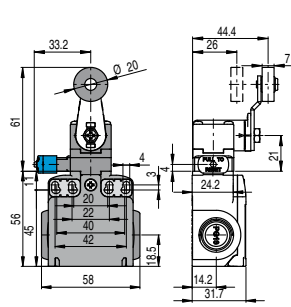

Other rollers available. See page 2/76

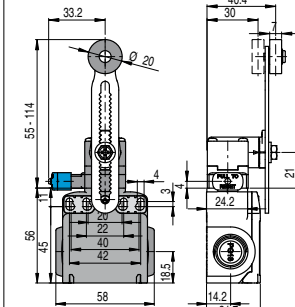

Other rollers available. See page 2/76

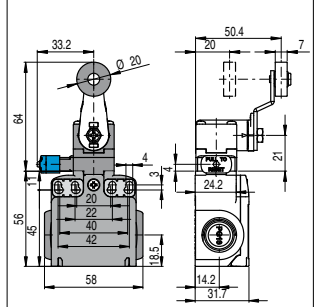

Contact blocks

6	L	FX 652-W3	➔ 1NO+1NC	FX 654-W3	➔ 1NO+1NC	FX 656-W3	➔ 1NO+1NC	FX 657-W3	➔ 1NO+1NC
9	L	FX 952-W3	➔ 2NC	FX 954-W3	➔ 2NC	FX 956-W3	➔ 2NC	FX 957-W3	➔ 2NC
10	L	FX 1052-W3	2NO	FX 1054-W3	2NO	FX 1056-W3	2NO	FX 1057-W3	2NO
20	L	FX 2052-W3	➔ 1NO+2NC	FX 2054-W3	➔ 1NO+2NC	FX 2056-W3	➔ 1NO+2NC	FX 2057-W3	➔ 1NO+2NC
21	L	FX 2152-W3	➔ 3NC	FX 2154-W3	➔ 3NC	FX 2156-W3	➔ 3NC	FX 2157-W3	➔ 3NC
22	L	FX 2252-W3	➔ 2NO+1NC	FX 2254-W3	➔ 2NO+1NC	FX 2256-W3	➔ 2NO+1NC	FX 2257-W3	➔ 2NO+1NC
2	R	FX 252-W3	2NO+2NC	FX 254-W3	2NO+2NC	FX 256-W3	2NO+2NC	FX 257-W3	2NO+2NC
Max speed		page 7/5 - type 1		page 7/5 - type 1		page 7/5 - type 1		page 7/5 - type 1	
Min. force		0,06 Nm (0,25 Nm ➔)		0,06 Nm (0,25 Nm ➔)		0,06 Nm (0,25 Nm ➔)		0,06 Nm (0,25 Nm ➔)	
Travel diagrams		page 7/7 - group 4		page 7/7 - group 4		page 7/7 - group 4		page 7/7 - group 4	

Items with code on the **green** background are available in stock

Position switches with revolving lever without actuator

Contacts type:

- R** = snap action
- L** = slow action
- LO** = slow action overlapped
- LS** = slow action shifted
- LV** = slow action shifted and spaced
- LI** = slow action independent
- LA** = slow action closer
- E1** = electronic PNP

Contact blocks

Contact blocks	Contacts type	Model	Contact configuration	With manual reset knob
5	R	FX 538	1NO+1NC	
6	L	FX 638	1NO+1NC	FX 638-W3 1NO+1NC
7	LO	FX 738	1NO+1NC	
9	L	FX 938	2NC	FX 938-W3 2NC
10	L	FX 1038	2NO	FX 1038-W3 2NO
11	R	FX 1138	2NC	
12	R	FX 1238	2NO	
13	LV	FX 1338	2NC	
14	LS	FX 1438	2NC	
15	LS	FX 1538	2NO	
16	LI	FX 1638	2NC	
18	LA	FX 1838	1NO+1NC	
20	L	FX 2038	1NO+2NC	FX 2038-W3 1NO+2NC
21	L	FX 2138	3NC	FX 2138-W3 3NC
22	L	FX 2238	2NO+1NC	FX 2238-W3 2NO+1NC
2	R	FX 238	2x(1NO-1NC)	FX 238-W3 2NO+2NC
E1	E1	FX E138	1NO-1NC	
Min. force		0,06 Nm (0,25 Nm)		0,06 Nm (0,25 Nm)
Travel diagrams		page 7/6 - group 5		page 7/7 - group 4

IMPORTANT

For safety applications: join only switches and actuators marked with symbol \ominus .
For more information about safety applications see page 7/1.

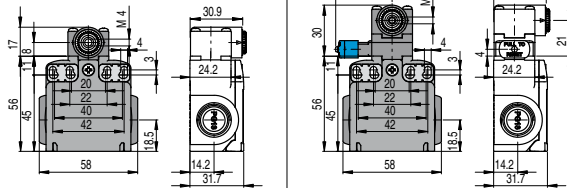

Loose actuators

IMPORTANT: These loose actuators can be used with items of series FR, FM, FX, FZ, FK only.

Polymer roller Ø 18 mm	Polymer roller Ø 18 mm	Adjustable square rod 3x3x125 mm	Flexible rod actuator	Adjustable round rod Ø 3x125 mm	Polymer roller Ø 20 mm	
VF LE30 \ominus	VF LE31 \ominus	VF LE33	VF LE34	VF LE50	VF LE51 \ominus	
Polymer roller Ø 20 mm	Porcelain roller	Polymer roller Ø 20 mm	Adjustable actuator with polymer roller	Adjustable safety actuator with polymer roller	Polymer roller Ø 20 mm	Adjustable fiber glass rod
VF LE52 \ominus	VF LE53 \ominus ⁽²⁾	VF LE54 \ominus	VF LE55 \ominus ⁽¹⁾	VF LE56 \ominus	VF LE57 \ominus	VF LE69

- Only orders for multiple quantities of the packs are accepted.

- (1) Actuator VF LE55 suits to safety applications only if adjusted to its max length, as you can see in figure beside. If you need an adjustable lever for safety applications, use the adjustable safety lever VF LE56.

- (2) The position switch obtained by assembling the switch FX •38 (e.g. FX 538, FX 638) with the actuator VF LE53 will not present the same travel diagrams and actuating forces as the position switch FX •53-E0V9 (e.g. FX 553-E0V9, FX 653-E0V9...).

- (4) The actuator cannot be oriented to inside direction because it will mechanically interfere with the switch head.

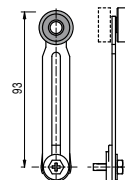

Accessories See page 6/1



Special loose actuators

IMPORTANT: These loose actuators can be used with items of series FR, FM, FX, FZ, FK only.

Ø 20 mm stainless steel rollers

VF LE31-1 (4)	VF LE51-1 (4)	VF LE52-1 (4)	VF LE54-1 (4)	VF LE55-1 (1)	VF LE56-1 (4)	VF LE57-1 (4)

Ø 35 mm polymer rollers

VF LE31-2 (4)	VF LE51-2 (4)	VF LE52-2 (4)	VF LE54-2 (4)	VF LE55-2 (1)	VF LE56-2 (4)	VF LE57-2 (4)

Ø 40 mm rubber rollers

VF LE31-R5 (4)	VF LE51-R5 (4)	VF LE52-R5 (4)	VF LE54-R5 (4)	VF LE55-R5 (1)	VF LE56-R5 (4)	VF LE57-R5 (4)

Ø 50 mm rubber rollers

VF LE51-3 (4)	VF LE52-3 (4)	VF LE54-3 (4)	VF LE55-3 (1)	VF LE56-3 (4)	VF LE57-3 (4)

Ø 50 mm overhanging rubber rollers

VF LE55-4 (1)	VF LE56-4 (4)

Items with code on the green background are available in stock

X-ON Electronics

Largest Supplier of Electrical and Electronic Components

Click to view similar products for [Limit Switches](#) category:

Click to view products by [Pizzato](#) manufacturer:

Other Similar products are found below :

[6LS2-4PG](#) [5ML1-E1](#) [5ML31](#) [LZG1](#) [LZL1-6C](#) [622EN114-R](#) [622EN18-6](#) [622EN224-6B](#) [622EN230](#) [622EN237-R](#) [622EN69-3](#) [622EN85-RB](#)
[MA-10019](#) [6PA109](#) [7LS51](#) [83547001](#) [83725002](#) [83830001](#) [83840001](#) [83840701](#) [83841001](#) [83870104](#) [83881140](#) [8AS42](#) [8LS10](#) [8LS125-](#)
[4PG](#) [8LS152-4PGN20](#) [914CE16-3A](#) [914CE16-AQ](#) [914CE3-3L1](#) [915PA10](#) [91MCE16-P2O](#) [924CE16-Y3](#) [924CE1-S6](#) [924CE1-T25A](#)
[924CE1-T3](#) [924CE1-T9A](#) [924CE2-T9](#) [924CE31-Y20-X5](#) [924CE31-Y3L1](#) [GL-10054](#) [GL-85710](#) [GL-85714](#) [GLAB26J2B](#) [GLDB03C-6](#)
[GLZ324](#) [PS21R-NT11N7-YK0](#) [D4A-1106N](#) [D4A1201N](#) [D4A-3E02N](#)