

METRIC THREAD (TM)

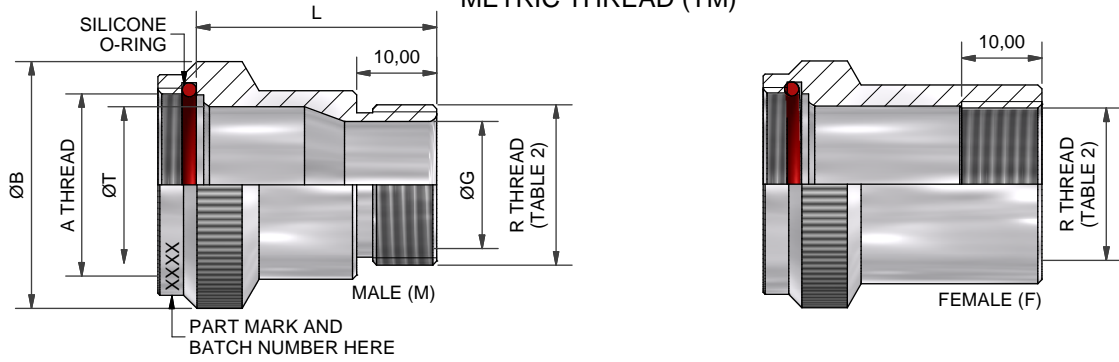

UNIFIED THREAD (TU)

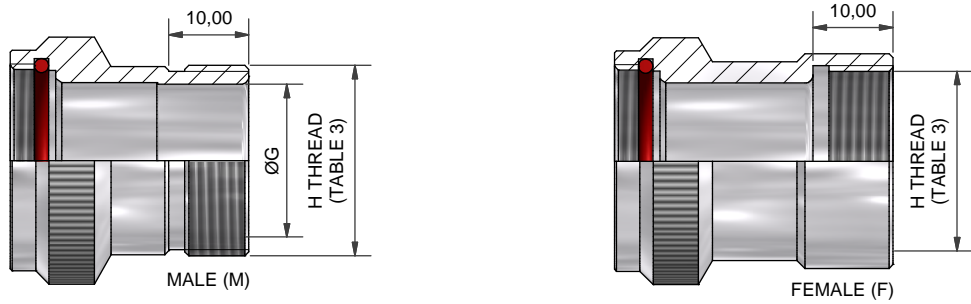

PG THREAD (PG)

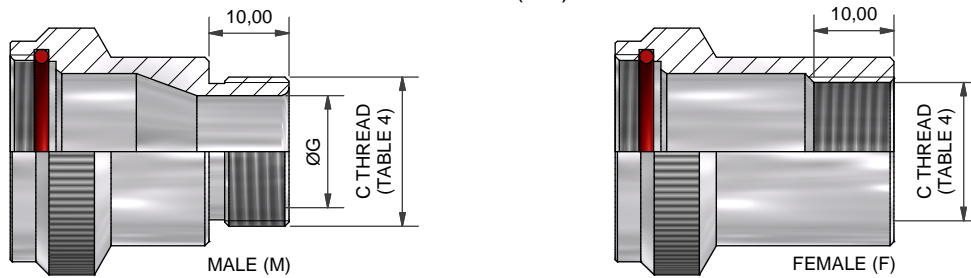

NPT THREAD (NP)

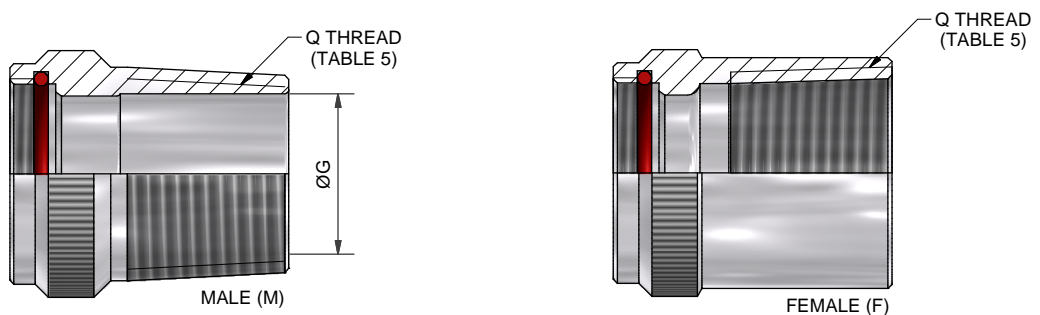

DRAWN	K.WINCZURA	DATE	21/05/2013
SALES APPR		DATE	21/05/2013
DESIGN APPR	K.SHEPPARD	DATE	08/08/2013
PROD APPR			
QUAL APPR			
ISSUE	DCR		
1	---		
NCAGE CODE	U5792	WEIGHT	---

3RD ANGLE PROJECTION NOT TO SCALE

UNLESS OTHERWISE SPECIFIED ALL DIMENSIONS IN MILLIMETRES

GENERAL TOL
 LINEAR +/-0.25MM
 ANGULAR +/- 1°

MATERIAL
 SEE PART NUMBER BREAKDOWN

FINISH
 SEE PART NUMBER BREAKDOWN



POLAMCO LTD
 www.polamco.com

WESTON LOCK
 LOWER BRISTOL ROAD
 BATH BA2 1EP

THIS DRAWING IS COPYRIGHT AND THE PROPERTY OF POLAMCO LTD
 IT MUST NOT BE COPIED, USED FOR MANUFACTURE OR OTHERWISE DISCLOSED WITHOUT PRIOR WRITTEN CONSENT OF THE COMPANY.

ASSY USED ON: MIL-DTL-38999 SERIES I & II

TITLE:
 THREAD ADAPTOR (DIRECT COUPLING)

PART NUMBER:
 TM-D, TU-D, PG-D, NP-D SERIES

DRAWING NO: P25959
 SHT 1

TABLE 1

ORDER NUMBER	SHELL SIZE SERIES I	SHELL SIZE SERIES II	A THREAD	ØB MAX	ØT MIN
08	09	08	7/16-28UNEF	18,3	6,6
10	11	10	9/16-24UNEF	21,5	10,0
12	13	12	11/16-24UNEF	24,5	12,9
14	15	14	13/16-20UNEF	27,8	16,1
16	17	16	15/16-20UNEF	30,8	19,3
18	19	18	1 1/16-18UNEF	34,1	21,7
20	21	20	1 3/16-18UNEF	37,3	24,8
22	23	22	1 5/16-18UNEF	40,5	28,2
24	25	24	1 7/16-18UNEF	43,7	31,3

TABLE 2: METRIC THREAD (TM)

DASH NUMBER	R THREAD	ØG
16	M16x1.5	11,85
20	M20x1.5	15,85
22	M22x1.5	17,85
25	M25x1.5	20,85
32	M32x1.5	27,85
40	M40x1.5	35,85

TABLE 3: UNIFIED THREAD (TU)

DASH NUMBER	H THREAD	ØG MIN
04	7/16-28UNEF	6,35
05	1/2-20UNF	7,92
06	9/16-24UNEF	9,52
07	5/8-24UNEF	11,12
08	11/16-24UNEF	12,70
09	3/4-20UNEF	14,27
10	13/16-20UNEF	15,88
11	7/8-20UNEF	17,46
12	15/16-20UNEF	19,05
13	1-20UNEF	20,64
14	1 1/16-18UNEF	22,23
15	1 1/8-18UNEF	23,81
16	1 3/16-18UNEF	25,40
17	1 1/4-18UNEF	26,99
18	1 5/16-18UNEF	28,58
19	1 3/8-18UNEF	30,16
21	1 1/2-18UNEF	33,34
23	1 5/8-18UNEF	36,51

TABLE 4: PG THREAD (PG)

DASH NUMBER	C THREAD	ØG
7	PG7	8,0
9	PG9	10,6
11	PG11	14,0
13.5	PG13.5	15,8
16	PG16	17,9
21	PG21	23,5
29	PG29	32,1

TABLE 5: NPT THREAD (NP)

DASH NUMBER	Q THREAD DESIGNATION	ØG	L(M) MIN	L(F) MIN
0250	1/4 NPT	7,60	25,00	25,00
0375	3/8 NPT	11,00	26,00	26,00
0500	1/2 NPT	14,70	30,00	30,00
0750	3/4 NPT	20,00	30,00	30,00
1000	1 NPT	26,20	35,00	35,00
1250	1 1/4 NPT	35,00	36,00	36,00
1500	1 1/2 NPT	41,00	36,00	36,00
2000	2 NPT	53,00	37,00	37,00
2500	2 1/2 NPT	64,50	50,00	50,00



TABLE 6

CODE	MATERIAL / PLATING
1-C	ALUMINIUM / ELECTROLESS NICKEL
1-B	ALUMINIUM / CADMIUM OLIVE DRAB OVER ELECTROLESS NICKEL
1-ZB	ALUMINIUM / ZINC COBALT OLIVE DRAB OVER ELECTROLESS NICKEL
1-ZN	ALUMINIUM / ZINC NICKEL BLACK PASSIVATE OVER ELECTROLESS NICKEL
4-J	STAINLESS STEEL / PASSIVATE
2-Z	NICKEL ALUMINIUM BRONZE / SHOT BLAST

LIST NOT EXHAUSTIVE, SEE PLATING TABLE FOR OTHER OPTIONS

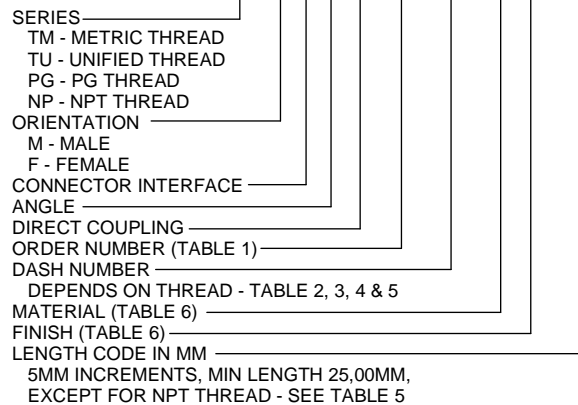
TMMF1-D16-20-1-C-L30



DRAWN	K.WINCZURA	DATE	21/05/2013	 3RD ANGLE PROJECTION NOT TO SCALE	 POLAMCO LTD www.polamco.com	WESTON LOCK LOWER BRISTOL ROAD BATH BA2 1EP	THIS DRAWING IS COPYRIGHT AND THE PROPERTY OF POLAMCO LTD IT MUST NOT BE COPIED, USED FOR MANUFACTURE OR OTHERWISE DISCLOSED WITHOUT PRIOR WRITTEN CONSENT OF THE COMPANY.
SALES APPR			21/05/2013				
DESIGN APPR	K.SHEPPARD	DATE	08/08/2013	UNLESS OTHERWISE SPECIFIED ALL DIMENSIONS IN MILLIMETRES GENERAL TOL LINEAR +/-0.25MM ANGULAR +/- 1°	ASSY USED ON: MIL-DTL-38999 SERIES I & II	TITLE: THREAD ADAPTOR (DIRECT COUPLING)	DRAWING NO: SHT P25959 2
PROD APPR							
QUAL APPR				MATERIAL SEE PART NUMBER BREAKDOWN FINISH SEE PART NUMBER BREAKDOWN	PART NUMBER: TM-D, TU-D, PG-D, NP-D SERIES		
ISSUE	DCR		---				
1							
NCAGE CODE U5792		WEIGHT	---				

X-ON Electronics

Largest Supplier of Electrical and Electronic Components

Click to view similar products for [Circular MIL Spec Backshells](#) category:

Click to view products by [TE Connectivity](#) manufacturer:

Other Similar products are found below :

[5M2919-3DW](#) [5M2920-3CW](#) [5M2953-1HW](#) [60-036152-022](#) [610HS012M15](#) [M28840/504WA](#) [M28840/805WB](#) [M28840/809WA](#)
[M28840/815WA](#) [M28840/816WA](#) [627AS017M14](#) [62GB5851608S](#) [655HS002NF11](#) [CW3703-000](#) [CW3899-000](#) [M85049/10-134S](#)
[M85049/10-17S](#) [M85049/10-33S](#) [M85049/10-94W](#) [M85049/11-09W](#) [M85049/11-28N](#) [M85049/11-37N](#) [M85049/11-53N](#) [M85049/11-63N](#)
[M85049/118-20W](#) [M85049/124-23W](#) [M85049/124S09W](#) [M85049/126S23W](#) [M850491712W02](#) [M85049/1720N04B](#) [M85049/1817N06](#)
[M850491819W03](#) [M85049/1821W05C](#) [M85049/1825W06C](#) [M85049/1919N05](#) [M85049/1919W04](#) [M850491919W07](#) [M85049/23-59W](#)
[M85049/23-74W](#) [M8504924-5W](#) [M85049/24-71N](#) [M85049/25-47N](#) [M85049/25-94W](#) [M85049/27S12N](#) [M8504938-13S](#) [M85049/38-19S](#)
[M85049/39-11S](#) [M85049/39-17S](#) [M85049/39-9S](#) [M85049/3W4A2](#)