



more sensors, more solutions

EZ-SCREEN® Safety Light Screen

Original Instruction Manual

Features

- An optoelectronic safeguarding device
- Standard and cascadeable models available
- Compact package for smaller production machines, robust for large power presses
- Creates a screen of synchronized, modulated infrared sensing beams. Choose from two resolutions, sized in 150 mm (6") increments:
14 mm (0.55") resolution models with defined areas from 150 mm to 1.8 m (6" to 71")
30 mm (1.18") resolution models with defined areas from 150 mm to 2.4 m (6" to 94.5")
- Optional remote Test input terminals for simulating a "blocked" condition (available on some emitter models)
- Easily configured Reduced Resolution (Floating Blanking)
- Three-digit display provides diagnostic information and indicates number of beams blocked
- Zone indicators identify blocked beams
- FMEA tested to ensure control reliability
- Receiver LEDs provide system status and emitter/receiver alignment indications
- Highly immune to EMI, RFI, ambient light, weld flash, and strobe light
- Two-piece design with External Device Monitoring
- Aux. output option to monitor the state of the OSSDs
- Vibration-tolerant, factory burned-in emitter and receiver circuitry for toughness and dependability
- Up to four pairs of emitters and receivers of different lengths can be cascadeable (SLSC.. models)
- Safety PLC input compatible (per OSSD specifications)

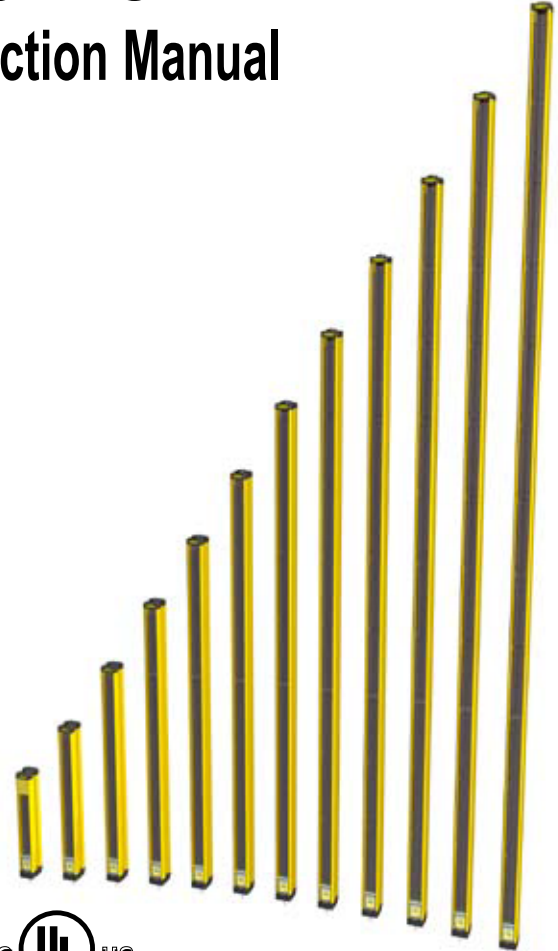

Section Contents

Section 1	Introduction	Page 1
Section 2	System Components and Specifications	Page 6
Section 3	Installation and Alignment	Page 21
Section 4	System Operation	Page 41
Section 5	Troubleshooting and Maintenance	Page 46
Section 6	Checkout Procedures	Page 51
Section 7	Cascadeable EZ-SCREEN	Page 53



1. System Overview	page 1
1.1 Introduction.....	1
1.2 Applications and Limitations.....	2
1.3 Control Reliability: Redundancy and Self-Checking.....	2
1.4 Operating Features.....	3
2. System Components and Specifications	Page 6
2.1 Emitter and Receiver Models – 14 mm.....	7
2.2 Emitter and Receiver Models – 30 mm.....	8
2.3 Cables.....	9
2.4 Accessories.....	10
2.5 Replacement Parts.....	16
2.6 Literature.....	16
2.7 Specifications.....	17
3. Installation and Alignment	Page 21
3.1 Mechanical Installation Considerations.....	21
3.2 Mechanical Mounting Procedure.....	28
3.3 Initial Electrical Connections.....	29
3.4 Light Screen Initial Checkout.....	30
3.5 Electrical Interface to the Guarded Machine (Permanent Hookup).....	34
3.6 Preparing for System Operation.....	38
3.7 Sensor “Swapability” and the Optional Emitter Hookup.....	38
4. System Operation	Page 41
4.1 Security Protocol.....	41
4.2 System Configuration Settings.....	41
4.3 Reset Procedures.....	42
4.4 Status Indicators.....	43
4.5 Normal Operation.....	46
4.6 Periodic Checkout Requirements.....	46
5. Troubleshooting and Maintenance	Page 47
5.1 Troubleshooting Lockout Conditions.....	47
5.2 Test Mode.....	50
5.3 Electrical and Optical Noise.....	51
5.4 Servicing and Maintenance.....	51
6. Checkout Procedures	Page 52
6.1 Schedule of Checkouts.....	52
6.2 Commissioning Checkout.....	52
6.3 Shift/Daily Checkout.....	53
6.4 Semi-Annual (Six-Month) Checkout.....	53
7. Cascadeable EZ-SCREEN	Page 54
7.1 Overview of Cascading.....	54
7.2 Cascadeable Emitter and Receiver Models – 14 mm.....	55
7.3 Cascadeable Emitter and Receiver Models – 30 mm.....	56
7.4 Determining Interconnect Cable Lengths.....	57
7.5 Response Time for Cascaded Light Screens.....	59
7.6 Cascaded Sensor Configuration Settings.....	61
7.7 Programming for Cascaded Operation.....	61
7.8 E-Stop Buttons and Rope/Cable Pulls.....	62
7.9 Positive-Opening Safety Interlock Switches.....	63
Glossary of Terms	Page 65
Safety Standards and Regulations	Inside Back Cover

Important ... read this page before proceeding!

In the United States, the functions that EZ-SCREEN is intended to perform are regulated by the Occupational Safety and Health Administration (OSHA). Outside of the United States, these functions are regulated by other agencies, organizations, and governments. Whether or not any particular EZ-SCREEN installation meets all applicable requirements depends upon factors that are beyond the control of Banner Engineering Corp. These factors include the details of how the EZ-SCREEN is applied, installed, wired, operated, and maintained. **It is the responsibility of the purchaser and user to apply this EZ-SCREEN System in full compliance with all relevant applicable regulations and standards.**

EZ-SCREEN can guard against accidents only when it is properly installed and integrated into the machine, properly operated, and properly maintained. Banner Engineering Corp. has attempted to provide complete application, installation, operation, and maintenance instructions. In addition, please direct any questions regarding application or use of EZ-SCREEN to the factory applications department at the telephone number or addresses shown on the back cover.

In addition to OSHA regulations, several other organizations provide information about the use of safeguarding devices. Refer to the American National Standards Institute (ANSI), the Robotics Industries Association (RIA), the Association for Manufacturing Technology (AMT), and others (see below). Banner Engineering Corp. makes no claim regarding a specific recommendation of any organization, the accuracy or effectiveness of any information provided, or the appropriateness of the provided information for a specific application.

The user has the responsibility to ensure that all local, state, and national laws, rules, codes, and regulations relating to the use of this safeguarding system in any particular application are satisfied. Extreme care is urged to ensure that all legal requirements have been met and that all installation and maintenance instructions contained in this manual are followed.

U.S. Standards Applicable to Use of EZ-SCREEN

OSHA 29CFR1910 Occupational Safety and Health Standards
ANSI B11 Standards Safeguarding of Machine Tools
ANSI/RIA R15.06 Safety Requirements for Robot Systems
NFPA 79 Electrical Standard for Industrial Machinery

See inside back cover for information pertaining to applicable U.S., European and International standards, and where to acquire copies.

1. System Overview

1.1 Introduction

The Banner EZ-SCREEN provides a redundant, microprocessor-controlled, opposed-mode optoelectronic “curtain of light,” or “safety light screen.” It typically is used for point-of-operation safeguarding, and is suited to safeguard a variety of machinery.

EZ-SCREEN is extensively FMEA (Failure Mode and Effects Analysis) tested to establish an extremely high degree of confidence that when properly installed, no system component will (even if it should fail) cause a failure to danger.

In typical operation, if any part of an operator’s body (or any opaque object) of more than a pre-determined cross section is detected, the OSSD solid-state safety outputs will turn off. These safety outputs are connected to the guarded machine’s Final Switching Devices (FSDs) that control the primary control elements (MPCEs), which immediately stop the motion of the guarded machine.

The OSSD (Output Signal Switching Device) safety outputs are capable of performing a “handshake” communication with the Muteable Safety Stop Interface (MSSI) or Universal Safety Stop Interface (USSI) found on other Banner Engineering safety products.

Banner EZ-SCREEN is a two-piece (“two-box”) system – comprising an emitter and a receiver, but no external controller. The External Device Monitoring (EDM) function ensures the fault detection capability required by U.S. Control Reliability and ISO13849-1 Categories 3 and 4 without a third box, a controller or a “smart” (i.e., self-checking) safety module required of systems without EDM.

An auxiliary (aux.) output may be used to signal the state of the OSSDs to a process controller; see Section 1.4.3.

Emitters have a row of synchronized modulated infrared (invisible) light-emitting diodes (LEDs) in a compact rectangular metal housing. Receivers have a corresponding row of synchronized photodetectors. The dimensions of the light screen created by the emitter and receiver are called the “defined area”; its width and height are determined by the length of the sensor pair and the distance between them. The maximum range is dependent on the resolution; range decreases if corner mirrors are used. Emitter and receiver pairs with 14 mm (0.55”) resolution have a maximum range of 6 m (20’), and pairs with 30 mm (1.18”) resolution have a maximum range of 18 m (60’).

Electrical connections are made through M12 (or Euro-style) quick-disconnects. Some emitter models have a 5-pin connector for power and the Test function. Other emitters and all receivers have an 8-pin connector for power, ground, inputs and outputs.

Functions such as Trip/Latch select, Display Invert, Cascading, Fixed Blanking, Reduced Resolution (Floating Blanking), Scan Code select, and External Device Monitoring are described in Section 1.4. All models require a supply voltage of +24V dc $\pm 15\%$. See Section 2.4 for interfacing solutions.

Both emitter and receiver feature 7-segment Diagnostic Displays and individual LEDs to provide continuous indication of the EZ-SCREEN’s operating status, configuration and error conditions. See Section 1.4.7 for more information.

This manual contains numerous WARNING and CAUTION statements. Warnings refer to situations that could lead to significant or serious personal injury or death. Cautions refer to situations that could lead to slight personal injury or potential damage to equipment.



Figure 1-1. A typical EZ-SCREEN application: weld cell

1.2 Applications and Limitations

The Banner EZ-SCREEN is intended for point-of-operation machine guarding applications and other safeguarding applications. It is the user's responsibility to verify whether the safeguarding is appropriate for the application and is installed, as instructed by this manual, by a Qualified Person.

Before installing the EZ-SCREEN, read this manual in its entirety, paying particular attention to this section and all of Section 3. The EZ-SCREEN's ability to perform its safeguarding function depends upon the appropriateness of the application and upon its proper mechanical and electrical installation and interfacing to the guarded machine. **If all mounting, installation, interfacing, and checkout procedures are not followed properly, the EZ-SCREEN cannot provide the protection for which it was designed.**

EZ-SCREEN is typically used, but is not limited to, the following applications:

- Small assembly equipment
- Molding and power presses
- Automated production equipment
- Robotic work cells
- Assembly and packaging machines
- Lean manufacturing systems

EZ-SCREEN may NOT be used with the following machinery or unsuitable applications:

- Any machine that cannot be stopped immediately after a stop signal is issued, such as single-stroke (or "full-revolution") clutched machinery.
- Any machine with inadequate or inconsistent machine response time and stopping performance.
- Any machine that ejects materials or component parts through the defined area.
- In any environment that is likely to adversely affect photoelectric sensing efficiency. For example, corrosive chemicals or fluids or unusually severe levels of smoke or dust, if not controlled, may degrade sensing efficiency.
- As a tripping device to initiate or reinitiate machine motion (PSDI applications), unless the machine and its control system fully comply with the relevant standard or regulation (see OSHA 29CFR1910.217, ANSI/NFPA 79, ANSI B11, ANSI/RIA R15.06, ISO 12100, IEC 60204-1, IEC 61496, or other appropriate standard).

If an EZ-SCREEN is installed for use as a perimeter guard (i.e., where a pass-through hazard may exist), **the dangerous machine motion can be initiated by normal means only after the safeguarded area is clear of individuals and the EZ-SCREEN has been manually reset. See Section 3.1.2.**

WARNING . . . Read this Section Carefully Before Installing the System

The user is responsible for satisfying all local, state, and national laws, rules, codes, or regulations relating to the installation and use of this control system in any particular application. Take extreme care to meet all legal requirements and follow all installation and maintenance instructions contained in this manual.

The user has the sole responsibility to ensure that the EZ-SCREEN is installed and interfaced to the guarded machine by Qualified Persons in accordance with this manual and applicable safety regulations.

Carefully read this manual in its entirety, paying particular attention to Section 1.2 and all of Section 3, before installing the System. Failure to follow these instructions could result in serious bodily injury or death.

WARNING . . . Install EZ-SCREEN Only on Appropriate Applications

Banner EZ-SCREEN is for use only on machinery that can be stopped immediately after a stop signal is issued at any point in the machine's stroke or cycle, such as part-revolution clutched machines. Under no circumstances may EZ-SCREEN be used on full-revolution clutched machinery or in unsuitable applications as those listed at left. **If there is any doubt about whether or not your machinery is compatible with EZ-SCREEN, contact Banner's Application Engineers at the factory.**

1.3 Control Reliability: Redundancy and Self-Checking

Redundancy requires that EZ-SCREEN System circuit components be "backed up" to the extent that, if the failure of a single component will prevent effective machine stopping action when needed, that component must have a redundant counterpart which will perform the same function. The EZ-SCREEN is designed with redundant microprocessors.

Redundancy must be maintained for as long as the EZ-SCREEN is in operation. Because a redundant system is no longer redundant after a component has failed, EZ-SCREEN is designed to monitor itself continuously. A component failure detected by or within the self-checking system causes a "stop" signal to be sent to the guarded machine and puts the EZ-SCREEN into a Lockout condition.

Recovery from this type of Lockout condition requires:

- replacement of the failed component (to restore redundancy) and
- the appropriate reset procedure (see Section 1.4.8).

The Diagnostic Display is used to diagnose causes of a Lockout condition (see Section 5.1).

1.4 Operating Features

The Banner EZ-SCREEN models described by this manual feature several standard selectable functions:

- Reduced Resolution (Floating Blanking),
- Trip or Latch Output,
- External Device Monitoring (EDM),
- Auxiliary Output,
- Scan Code setting,
- Fixed Blanking,
- Inverted Display, and
- Cascading (available on SLSC.. models).

These functions are configured within the sensors, behind the access cover on the front of each sensor and in the sensor wiring configuration; see Sections 3 and 4.2 for more information and configuration DIP switches.

The resolution and the maximum range can be determined by the model number on the emitter and receiver. See Section 2 for a list of model numbers.

1.4.1 Selectable Trip/Latch Output

The setting for Trip or Latch Output also determines whether the System will enter RUN mode automatically or if it will require a manual reset first (see Sections 1.4.8 and 4.2). If the System is set for Trip Output, other measures must be taken to prevent a pass-through hazard; see Section 3.1.2 and the warning below for more information.

If Trip Output is selected, the OSSD outputs will turn ON after power is applied, and the receiver passes its internal self-test/synchronization and recognizes that all beams are clear. The Trip Output will also automatically reset after all beams are cleared. If Latch Output is selected, the EZ-SCREEN requires a manual reset for the OSSD outputs to turn ON, after power is applied and all beams are clear (see Section 4.5).

WARNING . . . Use of Trip/Latch Output

Application of power to the EZ-SCREEN components, the clearing of the defined area, or the reset of a Latch condition MUST NOT initiate dangerous machine motion. Machine control circuitry must be designed so that one or more initiation devices must be engaged (i.e., a conscious act) to start the machine – in addition to the EZ-SCREEN going into RUN mode. **Failure to follow these instructions could result in serious bodily injury or death.**

1.4.2 Emitter QD and Hookup Options

An EZ-SCREEN emitter with an 8-pin connector can be connected to its own power supply or to the receiver cable color-for-color (see Figures 3-19 and 3-20). The color-for-color hookup allows the emitter and receiver positions to be interchanged without rewiring.

NOTE: An EZ-SCREEN emitter with 5-pin connector and Test function (see Section 1.4.4) is not capable of the color-for-color hookup.

1.4.3 External Device Monitoring (EDM)

This feature allows the EZ-SCREEN System to monitor the status of external devices, such as MPCEs. The choices are 1- or 2-channel monitoring, or no monitoring. EDM is used when the EZ-SCREEN OSSD outputs directly control the MPCEs or other external devices; see Sections 3.5.3 and 4.2 for more information.

Auxiliary (Aux.) Output

An aux. output function is available when the receiver is configured for 1-channel EDM (for receivers with date code 0834 or newer). This current sourcing (PNP) solid-state output (75 mA max.) is used for control functions that are not safety-related. A typical use is to signal the state of the OSSDs to a programmable logic controller (PLC). The aux. output follows the state of the OSSDs. Pin 2 (orange/black) supplies the connection; see Section 3.5.5 and Figure 3-23.

1.4.4 Remote Test Input

On 5-pin EZ-SCREEN emitter models (model numbers SLSE...Q5; see Tables 2.1 and 2.2), a Test function is provided. A pair of wires is connected from the emitter (see Section 3.5.6) to an external switch, typically a normally open contact, held closed. Opening a switch connected between these two terminals “turns off” the emitter, simulating an interruption of one or more light beams. This remote Test input may be useful for EZ-SCREEN System setup and to verify machine control circuit operation.

1.4.5 Scan Code Configuration

The emitter and receiver may be configured to one of two Scan Code positions (1 or 2). Scan codes enable a receiver to recognize beams only from an emitter with the same Scan Code setting. This helps minimize the effects of crosstalk between multiple emitter/receiver pairs, and allows multiple pairs to operate in close proximity in certain situations. See Sections 3.1.5 and 3.1.8 for proper mounting configurations. The Scan Code is set using the selection switch in each sensor’s configuration port; see Section 4.2 for more information. Both the emitter and its corresponding receiver must be set to the identical setting.

1.4.6 Reduced Resolution (Floating Blanking)

Reduced Resolution increases the minimum diameter of an object that the light screen can reliably detect anywhere within its defined area. Reduced Resolution is generally used to allow one or more objects (usually workpiece materials) to move through the defined area, at any point, without tripping the OSSD safety outputs.

Selecting two-beam Reduced Resolution will reduce the overall minimum object sensitivity, which allows multiple objects to move through the defined area (see Section 3.4.2). The effect is that every two consecutive beams (except for the sync beam) can be blocked, but not cause the OSSDs to turn OFF. This is also called "Multiple-Point Floating Blanking."

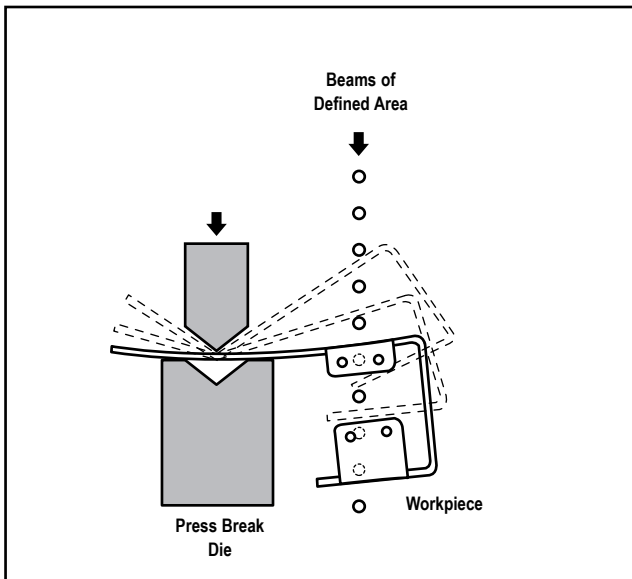

Figure 1-2. Reduced Resolution

Resolution directly affects the minimum allowable distance between the defined area of a light screen and the nearest hazard point (separation distance, see Section 3.1.1). The green status indicator on the receiver flashes when Reduced Resolution is enabled. The ignored object size and resultant Reduced Resolution are listed in Section 3.4.2.

1.4.7 Status Indicators

Status indicators on both the emitter and receiver are clearly visible on each sensor's front panel.

• **Emitter:**

Bi-color red/green Status indicator – shows whether power is applied, and whether the emitter is in RUN mode, TEST mode, or Lockout condition.

1-Digit Diagnostic Display – indicates specific error or configuration conditions.

• **Receiver:**

Bi-color red/green Zone indicators – show status of a group of beams:

- aligned and clear (green ON), or
- blocked and/or misaligned (red ON), or
- fixed blanked area (flashing green).

Yellow Reset indicator – shows System status:

- RUN mode (ON) or
- waiting for a reset (flashing).

Bi-color red/green Status indicator – shows System status:

- Reduced Resolution enabled (flashing green),
- outputs are ON or OFF (green ON or red ON), or
- the System is in Lockout condition (flashing red).

3-Digit Diagnostic Display – indicates specific error, configuration conditions, or total number of blocked beams.

See Sections 4.4 and 5.1 for more information about specific indicator and Diagnostic Display code meanings.

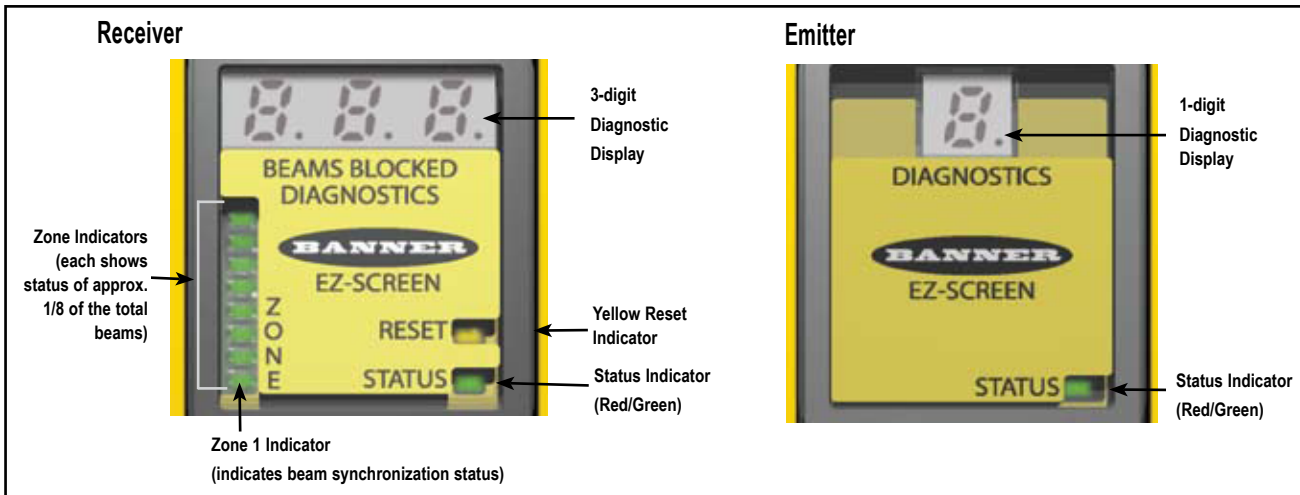

Figure 1-3. EZ-SCREEN emitter and receiver status indicators

1.4.8 Manual Resets and Lockout Conditions

Reset Routine

The EZ-SCREEN requires a manual reset to clear a Power-Up Lockout or Latch condition, and after correcting the cause of a Lockout condition. This function is designed to provide a “monitored manual reset” (i.e., open-closed-open action), such that a shorted or tied-down button cannot cause a reset. When a key-operated switch is used, this is typically called a key reset.

To perform a manual reset, close the normally open switch for at least 1/4 second, but no longer than 2 seconds, and then re-open the switch. See Sections 3.1.3 and 4.3 for further information.

A Lockout condition will cause the EZ-SCREEN OSSD outputs to turn OFF. A Lockout condition is indicated by a flashing Red Status indicator and an error number displayed on the Diagnostic Display. Internal Lockout conditions require a manual reset routine to return the system to RUN mode after the failure has been corrected and the input has been correctly cycled. A description of possible lockouts, their causes, and troubleshooting hints are listed in Section 5.

Trip Output/Auto Reset

While the use of a reset switch is recommended, it is not required for receivers configured for Trip Output (automatic reset). Cycling the supply power (OFF for > 2 seconds, then ON) will also clear lockouts if their cause has been corrected. If a reset switch is not used, leave pin 8 (violet wire) not connected (open) and secure it against shorting to a source of power or ground.

1.4.9 Fixed Blanking

The fixed blanking feature allows for a stationary object(s), such as tooling, to be ignored while it remains positioned in the defined area. A flashing Green Zone indicator denotes the location of a blanked area. If the object is moved or removed, the System goes into a lockout mode. This ensures that an unexpected hole in the sensing field is not created.

Fixed blanking is easily programmed, simply by positioning the objects, flipping two DIP switches and resetting the System, as described in Section 3.4.3.

1.4.10 Inverted Display

A push button, located under the access cover, can be used to invert the display. This is desirable when an emitter and receiver are mounted with the QD connector ends up. A replacement access cover with an inverted label is included with each emitter and receiver to accommodate inverted mounting. (See Section 4.4).

1.4.11 Cascadeable Models

Emitter and receiver models SLSC..* (see Section 7) are capable of interconnecting up to four emitter/receiver pairs – regardless of the resolution, the total number of beams, or the size of the defined area. EZ-SCREEN cascadeable models can also be used individually as stand-alone systems.

Special cabling is not required, but the double-ended 22 awg cordsets listed in Section 2.3 are recommended. See Section 7.4 for maximum cable lengths. Pigtail QD models may be used to reduce the number of required cables.

Response time is dependent on the number of beams in the light screen, and the light screen's position in the cascade. Maximum system response time can be calculated easily for these cascaded systems, in two ways:

- Individually for each light screen in the cascade (separation distance is calculated for each light screen in the cascade), or
- Based on the worst-case maximum for the entire cascade (all light screens in the cascade have the same separation distance).

See Section 7.5 for more information.

*Models SLSC..-150.. not available.

2. Components and Specifications

An EZ-SCREEN System includes a compatible emitter and receiver (equal length and resolution; available separately or in pairs), and two cables. Mounting hardware is included with each emitter and receiver. Interfacing solutions include IM-T.. modules, redundant positively guided contactors, or an optional muting module; see Section 2.4.

Standard models (as listed in the following tables) feature a yellow painted aluminum housing. Other housing finishes are also available, including black, white, and silver (nickel-plated); contact the factory for more information.

Standard models are listed with integral QD fitting; for a 300 mm (12") pigtail with M12/Euro-style 8-pin QD fitting, replace the "Q" in the model number with "P". The 13 mm (0.5") minimum bend radius accommodates low-clearance installations. When used in a cascade installation, the pigtail models can reduce the number of cables and improve clearance and cable management.

Electro-static Dissipative Models

Electro-static dissipative (ESD-safe) versions with nickel-plated housing are also available, with a static-dissipative polymer coating which protects nearby components from damaging ESD voltages.

NOTE: ESD-safe models are not available with the pigtail QD option.

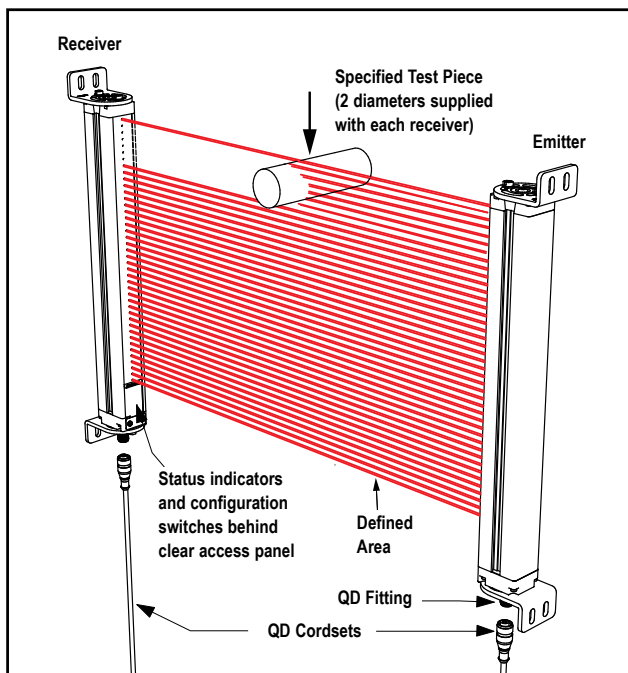

Figure 2-1. Banner EZ-SCREEN: emitter, receiver, and two interconnecting cables

2.1 Standard Emitter and Receiver Models (Non-Cascadeable) – 14 mm Resolution

Order one 8-pin cable for each 8-pin emitter or receiver, or one 5-pin cable for each 5-pin emitter; see Table 2.3. **For cascadeable emitter and receiver models, see Sections 7.2 and 7.3.**

Defined Area Height	Standard 14 mm Resolution Models† 0.1 m to 6 m (4" to 20") range				
	Emitter (8-pin)†	Receiver	Emitter/Receiver Pair†	Number of Beams	Response Time (Tr)
150 mm (5.9")	SLSE14-150Q8	SLSR14-150Q8	SLSP14-150Q88	20	11 ms
300 mm (11.8")	SLSE14-300Q8	SLSR14-300Q8	SLSP14-300Q88	40	15 ms
450 mm (17.7")	SLSE14-450Q8	SLSR14-450Q8	SLSP14-450Q88	60	19 ms
600 mm (23.6")	SLSE14-600Q8	SLSR14-600Q8	SLSP14-600Q88	80	23 ms
750 mm (29.5")	SLSE14-750Q8	SLSR14-750Q8	SLSP14-750Q88	100	27 ms
900 mm (35.4")	SLSE14-900Q8	SLSR14-900Q8	SLSP14-900Q88	120	32 ms
1050 mm (41.3")	SLSE14-1050Q8	SLSR14-1050Q8	SLSP14-1050Q88	140	36 ms
1200 mm (47.2")	SLSE14-1200Q8	SLSR14-1200Q8	SLSP14-1200Q88	160	40 ms
1350 mm (53.1")	SLSE14-1350Q8	SLSR14-1350Q8	SLSP14-1350Q88	180	43 ms
1500 mm (59")	SLSE14-1500Q8	SLSR14-1500Q8	SLSP14-1500Q88	200	48 ms
1650 mm (65")	SLSE14-1650Q8	SLSR14-1650Q8	SLSP14-1650Q88	220	52 ms
1800 mm (70.9")	SLSE14-1800Q8	SLSR14-1800Q8	SLSP14-1800Q88	240	56 ms

† Only standard 8-pin QD models are listed; 8-pin emitters/receivers feature "swappable" hookup; see Sections 3.3 and 3.7.

For other models:

5-pin emitters with Test input: Replace suffix "Q8" with "Q5", (e.g., SLSE14-150Q5), and for the pair replace "Q88" with "Q85" (e.g., SLSP14-150Q85).

Pigtail QD (8-pin models only): Replace the "Q" in the model number with "P" (e.g., SLSE14-150P8).

ESD-safe models: Add "N" to the model number, prior to the QD option designation (e.g., SLSE14-150NQ8). ESD-safe models are not available with the pigtail QD option.

Optional housing finishes: Prior to the QD designation in the model number, add "A" for a clear (brushed) anodized aluminum finish, black endcaps (e.g., SLSE14-150AQ8), add "S" for a nickel-plated ("silver") finish, black endcaps (e.g., SLSE14-150SQ8), add "B" for a black painted finish, black endcaps (e.g., SLSE14-150BQ8), add "W" for a white painted finish, black endcaps (e.g., SLSE14-150WQ8), or add "SO" for a "safety orange" painted finish, black endcaps (e.g., SLSE14-150SOQ8).

2.2 Standard Emitter and Receiver Models (Non-Cascadeable) – 30 mm Resolution

Order one 8-pin cable for each 8-pin emitter or receiver, or one 5-pin cable for each 5-pin emitter; see Table 2.3. *For cascadeable emitter and receiver models, see Sections 7.2 and 7.3.*

Defined Area Height	Standard 30 mm Resolution Models [†] 0.1 m to 18 m (4" to 60') range				
	Emitter (8-pin) [†]	Receiver	Emitter/Receiver Pair [†]	Number of Beams	Response Time (Tr)
150 mm (5.9")	SLSE30-150Q8	SLSR30-150Q8	SLSP30-150Q88	10	9 ms
300 mm (11.8")	SLSE30-300Q8	SLSR30-300Q8	SLSP30-300Q88	20	11 ms
450 mm (17.7")	SLSE30-450Q8	SLSR30-450Q8	SLSP30-450Q88	30	13 ms
600 mm (23.6")	SLSE30-600Q8	SLSR30-600Q8	SLSP30-600Q88	40	15 ms
750 mm (29.5")	SLSE30-750Q8	SLSR30-750Q8	SLSP30-750Q88	50	17 ms
900 mm (35.4")	SLSE30-900Q8	SLSR30-900Q8	SLSP30-900Q88	60	19 ms
1050 mm (41.3")	SLSE30-1050Q8	SLSR30-1050Q8	SLSP30-1050Q88	70	21 ms
1200 mm (47.2")	SLSE30-1200Q8	SLSR30-1200Q8	SLSP30-1200Q88	80	23 ms
1350 mm (53.1")	SLSE30-1350Q8	SLSR30-1350Q8	SLSP30-1350Q88	90	25 ms
1500 mm (59")	SLSE30-1500Q8	SLSR30-1500Q8	SLSP30-1500Q88	100	27 ms
1650 mm (65")	SLSE30-1650Q8	SLSR30-1650Q8	SLSP30-1650Q88	110	30 ms
1800 mm (70.9")	SLSE30-1800Q8	SLSR30-1800Q8	SLSP30-1800Q88	120	32 ms
1950 mm (76.8")	SLSE30-1950Q8	SLSR30-1950Q8	SLSP30-1950Q88	130	34 ms
2100 mm (82.7")	SLSE30-2100Q8	SLSR30-2100Q8	SLSP30-2100Q88	140	36 ms
2250 mm (88.6")	SLSE30-2250Q8	SLSR30-2250Q8	SLSP30-2250Q88	150	38 ms
2400 mm (94.5")	SLSE30-2400Q8	SLSR30-2400Q8	SLSP30-2400Q88	160	40 ms

[†] Only standard 8-pin QD models are listed; 8-pin emitters/receivers feature "swapable" hookup; see Sections 3.3 and 3.7.

For other models:

5-pin emitters with Test input: Replace suffix "Q8" with "Q5", (e.g., SLSE30-150Q5), and for the pair replace "Q88" with "Q85" (e.g., SLSP30-150Q85).

Pigtail QD (8-pin models only): Replace the "Q" in the model number with "P" (e.g., SLSE30-150P8).

ESD-safe models: Add "N" to the model number, prior to the QD option designation (e.g., SLSE30-150NQ8). ESD-safe models are not available with the pigtail QD option.

Optional housing finishes: Prior to the QD designation in the model number,
 add "A" for a clear (brushed) anodized aluminum finish, black endcaps (e.g., SLSE30-150AQ8),
 add "S" for a nickel-plated ("silver") finish, black endcaps (e.g., SLSE30-150SQ8),
 add "B" for a black painted finish, black endcaps (e.g., SLSE30-150BQ8),
 add "W" for a white painted finish, black endcaps (e.g., SLSE30-150WQ8), or
 add "SO" for a "safety orange" painted finish, black endcaps (e.g., SLSE30-150SOQ8).

2.3 Cables

Machine interface cables provide power to the first emitter/receiver pair. Sensor interconnect cables provide power to subsequent emitters and receivers in the cascade.

Single-Ended (Machine Interface) Cables (one cable for each emitter and receiver)

Overmold and cables are PVC-jacketed. Cables are unterminated on one end to interface with guarded machine.

Model Number	Length	Wire	Termination	Banner Cable Pinout/Color Code		European M12 Specification*		Connector (female face view)	
For 8-Pin Emitters and Receivers**				Pin	Color	Function	Pin	Color	Function
QDE-815D	4.5 m (15')	22 gauge	8-pin Euro-style female connector on one end; cut to length	1	Bn	+24V dc	1	Wh	+24V dc
QDE-825D	8 m (25')			2	Or/Bk	EDM #2 (Aux)	2	BN	EDM #2 (Aux)
QDE-850D	15 m (50')			3	Or	EDM #1	3	Gn	EDM #1
QDE-875D	23 m (75')			4	Wh	OSSD #2	4	Ye	OSSD #2
QDE-8100D	30 m (100')			5	Bk	OSSD #1	5	Gy	OSSD #1
				6	Bu	0V dc	6	Pk	0V dc
				7	Gn/Ye	Gnd/Chassis	7	Bu	Gnd/Chassis
				8	Vi	Reset	8	Rd	Reset
For 5-Pin Emitters and Receivers***				Pin	Color	Function	Pin	Color	Function
QDE-515D	4.5 m (15')	22 gauge	5-pin Euro-style female connector on one end; cut to length	1	Bn	+24V dc	1	Bn	+24V dc
QDE-525D	8 m (25')			2	Wh	Test #2	2	Wh	Test #2
QDE-550D	15 m (50')			3	Bu	0V dc	3	Bu	0V dc
QDE-575D	23 m (75')			4	Bk	Test #1	4	Bk	Test #1
QDE-5100D	30 m (100')			5	Gn/Ye	Gnd/Chassis	5	Shield	Gnd/Chassis

*The European M12 Specification pin assignment and color codes are listed as a customer courtesy. The user must verify suitability of these cables for each application.

**8-pin Systems require two 8-pin QD cables. Only pins 1, 6, and 7 are connected on 8-pin emitters (see Figure 3-16).

***5-pin EZ-SCREEN emitter, model numbers **SLSE...Q5** (see Table 2.1) with Test function (see Figure 3-17). One 5-pin and one 8-pin QD cable required for complete system.

Double-Ended (Sensor Interconnect) Cables

Double-ended cables are generally used to interconnect multiple emitters (8-pin or 5-pin) or receivers (8-pin) within a cascaded system. They are also useful for extending either the branch or trunk cables of a model CSB splitter cordset (see page 10). When combining cables in a multiple-light-screen cascade, refer to Section 7.4 for maximum cable lengths.

Model Number		Length	Wire	Termination
For 8-Pin Emitters and Receivers	For 5-Pin Emitters			
DEE2R-81D	DEE2R-51D	0.3 m (1')	22 gauge	5- or 8-pin Double-ended cables, M12/Euro-style connectors, female to male (rotateable)
DEE2R-83D	DEE2R-53D	1 m (3')		
DEE2R-88D	DEE2R-58D	2.4 m (8')		
DEE2R-815D	DEE2R-515D	4.5 m (15')		
DEE2R-825D	DEE2R-525D	8 m (25')		
DEE2R-850D	DEE2R-550D	15 m (50')		
DEE2R-875D	DEE2R-575D	23 m (75')		
DEE2R-8100D	DEE2R-5100D	30 m (100')		



Splitter Cordsets

Model CSB splitter cordsets allow easy interconnection between an EZ-SCREEN 8-pin receiver and its 8-pin emitter, providing a single “homerun” cable for the optional “swapable” hookup (see Figure 3-16). The model DEE2R-.. double-ended cables described on page 8 may be used to extend the lengths of the QD trunk, branch #1, or branch #2. **(Branch #1 and branch #2 cable sections are 300 mm/1' long.)** The model QDE-8..D single-ended cables may be used to extend the QD trunk for cut-to-length applications.

Model Number	Trunk Length	Wire	Pinout
CSB-M1281M1281 CSB-M1288M1281 CSB-M12815M1281 CSB-M12825M1281	0.3 m (1') 2.4 m (8') 4.5 m (15') 8 m (25')	22 gauge	
CSB-UNT825M1281	8 m (25') (unterminated)		

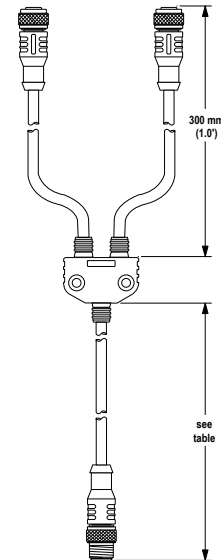

Bulkhead Connector

Model Number	Description
PMEF-810D	Connector for panel connection of EZ-SCREEN emitter and receiver cables. 8-pin Euro-style female connector with 3 m (10') wires cut to length (Banner color code); 22 gauge.

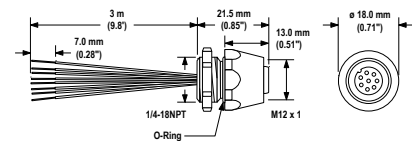

2.4 Accessories

Additional interfacing solutions and accessories continue to be added; refer to www.bannerengineering.com for a current list.

Interface Modules

Provide forced-guided, mechanically-linked relay (safety) outputs for the EZ-SCREEN. See Banner data sheet p/n 62822 and Figure 3-23 for more information.

Interface module (3 N.O. redundant-output 6 amp contacts)	IM-T-9A
Interface module (2 N.O. redundant-output 6 amp contacts, plus 1 N.C. auxiliary contact)	IM-T-11A

Contactors

The N.C. contacts are to be used in an External Device Monitoring (EDM) circuit. If used, two contactors per EZ-SCREEN System are required. (See Figure 3-18.)

10 amp positive-guided contactor 3 N.O., 1 N.C.	11-BG00-31-D-024
16 amp positive-guided contactor 3 N.O., 1 N.C.	BF1801L024

Muting Modules

Provide muting capability for the EZ-SCREEN. (**MM-TA-12B** is compatible with all 14 mm models 1200 mm and shorter, and with all 30 mm models. See Banner manuals p/n 63517 or 116390 for further information and additional cabling options.)

MMD-TA-11B	DIN-mount	2 NO safety outputs (6 amps), 2 or 4 muting inputs, SSI, override input; IP20; terminal connections
MMD-TA-12B	Muting module	2 OSSD (0.5 amps), 2 or 4 muting inputs, SSI, override input; IP20; terminal connections
MM-TA-12B	Muting module	2 OSSD (0.5 amps), 2 or 4 muting inputs, USSI, override input; IP65; QD connections, see below
DESE4-508D	2.5 m (8') cable	Cable to interface EZ-SCREEN Receiver with MM-TA-12B Muting Module – 22 Ga, 8-pin Euro-style (M12) female connector to 7-pin Mini-style male connector; double-ended
DESE4-515D	5 m (15') cable	
DESE4-525D	8 m (25') cable	



AC Boxes

AC power supply for use with EZ-SCREEN emitters and/or receivers. Models **EZAC-R..** can be interfaced with up to three receivers or two cascaded emitter/receiver pairs; models **EZAC-E..** can power up to four emitters.

Box supplies +24V dc power @ 0.7 amps (16.8 W max. power); accepts input voltages from 100-250V ac (50-60 Hz); IP65 metal housing. Models available with external device monitoring (EDM); key reset switch on **EZAC-R..** models (Receiver/Pair models). See data sheet p/n 120321 for more information.



Emitter/Receiver Boxes					
Model	Outputs	EDM	Emitter/Receiver Connection	AC Power Connection	Output and EDM Connections
EZAC-R9-QE8	3 N.O.	Selectable 1- or 2-Channel or no EDM	8-Pin M12 Euro-style QD	Hard-wired	Hard-wired
EZAC-R11-QE8	2 N.O., 1 N.C.				
EZAC-R15A-QE8-QS83	1 N.O. + 1 SPDT (Form C)	1-Channel		3-pin Mini-style QD	8-pin Mini-style QD
EZAC-R8N-QE8-QS53	1 N.O., 1 N.C.	Power Monitoring		3-pin Mini-style QD	5-pin Mini-style QD
EZAC-R10N-QE8-QS53	2 N.O.				

Emitter-Only Boxes			
Model	For Emitter Models	Emitter Connection	AC Power Connection
EZAC-E-QE8	SLSE...Q8 (without Test input)	8-Pin M12 Euro-style QD	Hard-wired
EZAC-E-QE5	SLSE...Q5 (with Test input)	5-Pin M12 Euro-style QD	
EZAC-E-QE8-QS3	SLSE...Q8 (without Test input)	8-Pin M12 Euro-style QD	3-Pin Mini-style QD
EZAC-E-QE5-QS5	SLSE...Q5 (with Test input)	5-Pin M12 Euro-style QD	5-Pin Mini-style QD

Remote Reset Switch

Keyed reset switch can be interconnected using cordset models **QDE-8..D**, **DEE2R-8..D**, or **CSB-..M1281**.

EZA-RR-1	Remote reset switch with 8-pin M12/Euro-style QD
-----------------	--

Lens Shields

NOTE: The total sensing range decreases by approximately 10% per shield.

Sensor Defined Area †	Adhesive-Backed Model ⁽¹⁾	Snap-On Model ⁽²⁾
150 mm	EZS-150	EZSS-150
300 mm	EZS-300	EZSS-300
450 mm	EZS-450	EZSS-450
600 mm	EZS-600	EZSS-600
750 mm	EZS-750	EZSS-750
900 mm	EZS-900	EZSS-900
1050 mm	EZS-1050	EZSS-1050
1200 mm	EZS-1200	EZSS-1200
1350 mm	EZS-1350	EZSS-1350
1500 mm	EZS-1500	EZSS-1500
1650 mm	EZS-1650	EZSS-1650
1800 mm	EZS-1800	EZSS-1800



Adhesive-backed model shown

† Contact factory for lens shield availability for longer sensor lengths.

⁽¹⁾ Polycarbonate shield guards against weld splatter and weld flash with an adhesive-backed neoprene gasket (see data sheet p/n 61960).

⁽²⁾ Copolyester shield provides heavy-duty, impact-resistant protection from many types of cutting fluids (see data sheet p/n 127944).

Tubular Enclosures

EZA-MBK-2 adapter bracket is required for use with MSA Series stand, see page 14 and data sheet P/N 117107.

Enclosure Model †	Enclosure Height	For EZ-SCREEN Models
EZA-TE-150	439 mm (17.3")	SLS.-150
EZA-TE-300	541 mm (21.3")	SLS.-300
EZA-TE-450	744 mm (29.3")	SLS.-450
EZA-TE-600	846 mm (33.3")	SLS.-600
EZA-TE-750	1024 mm (40.3")	SLS.-750
EZA-TE-900	1151 mm (45.3")	SLS.-900
EZA-TE-1050	1354 mm (53.3")	SLS.-1050
EZA-TE-1200	1455 mm (57.3")	SLS.-1200
EZA-TE-1350	1608 mm (63.3")	SLS.-1350
EZA-TE-1500	1760 mm (69.3")	SLS.-1500
EZA-TE-1650	1913 mm (75.3")	SLS.-1650
EZA-TE-1800	2065 mm (81.3")	SLS.-1800



Explosion-proof enclosures also available. Contact factory or visit www.bannerengineering.com for more information.

† Contact factory for enclosure availability for longer sensor lengths.

MSA Series Stands (Base Included)*

Stand Model	Pole Height	Useable Stand Height	Overall Stand Height
MSA-S24-1	610 mm (24")	483 mm (19")	616 mm (24.25")
MSA-S42-1	1067 mm (42")	940 mm (37")	1073 mm (42.25")
MSA-S66-1	1676 mm (66")	1550 mm (61")	1682 mm (66.25")
MSA-S84-1	2134 mm (84")	2007 mm (79")	2140 mm (84.25")
MSA-S105-1	2667 mm (105")	2667 mm (100")	2673 mm (105.25")

* Available without a base by adding the suffix "NB" to model number, e.g., MSA-S42-1NB.

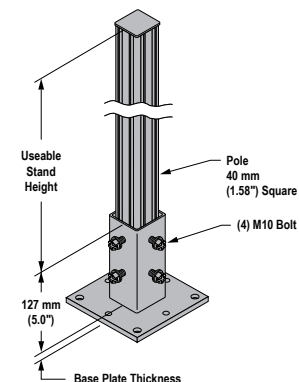

MSM Series Corner Mirrors

Rear-surface glass mirrors rated at 85% efficiency. *The total sensing range decreases by approximately 8% per mirror.* See mirror data sheet P/N 43685 or the Banner Safety catalog for further information.

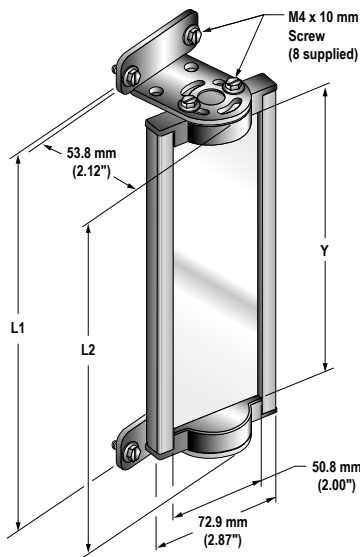

Defined Area Length	Mirror Model	Reflective Area Y	Mounting L1	Height L2
150 mm (5.9")	MSM8A	267 mm (10.5")	323 mm (12.7")	292 mm (11.5")
300 mm (11.8")	MSM12A	356 mm (14")	411 mm (16.2")	381 mm (15")
450 mm (17.7")	MSM20A	559 mm (22")	615 mm (24.2")	584 mm (23")
600 mm (23.6")	MSM24A	660 mm (26")	716 mm (28.2")	686 mm (27")
750 mm (29.5")	MSM32A	864 mm (34")	919 mm (36.2")	889 mm (35")
900 mm (35.4")	MSM36A	965 mm (38")	1021 mm (40.2")	991 mm (39")
1050 mm (41.3")	MSM44A	1168 mm (46")	1224 mm (48.2")	1194 mm (47")
1200 mm (47.2")	MSM48A	1270 mm (50")	1326 mm (52.2")	1295 mm (51")

SSM Series Corner Mirrors

Rear-surface glass mirrors rated at 85% efficiency. *The total sensing range decreases by approximately 8% per mirror.* See mirror data sheet P/N 61934 or the Banner Safety catalog for further information.

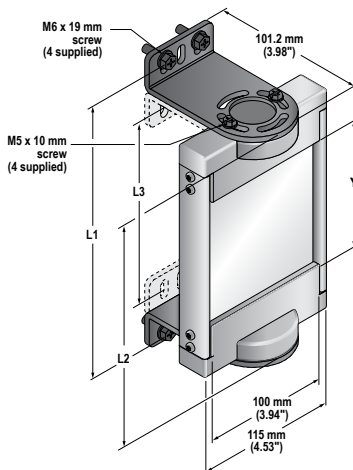

NOTE: Brackets may be inverted from the positions shown above, decreasing dimension L1 by 58 mm (2.3").









- Robust construction, two mounting brackets and hardware included.
- EZA-MBK-2 adapter bracket is required for use with MSA Series stand, see page 14.

Defined Area Length	Mirror Model*	Reflective Area Y	Mounting L1	Height L2
150 mm (5.9")	SSM-200	200 mm (7.9")	278 mm (10.9")	311 mm (12.2")
300 mm (11.8")	SSM-375	375 mm (14.8")	486 mm (19.1")	453 mm (17.8")
450 mm (17.7")	SSM-550	550 mm (21.7")	661 mm (26.0")	628 mm (24.7")
600 mm (23.6")	SSM-675	675 mm (26.6")	786 mm (31.0")	753 mm (29.6")
750 mm (29.5")	SSM-825	825 mm (32.5")	936 mm (36.9")	903 mm (35.6")
900 mm (35.4")	SSM-975	975 mm (38.4")	1086 mm (42.8")	1053 mm (41.5")
1050 mm (41.3")	SSM-1100	1100 mm (43.3")	1211 mm (47.7")	1178 mm (46.4")
1200 mm (47.2")	SSM-1275	1275 mm (50.2")	1386 mm (54.6")	1353 mm (53.3")
1350 mm (53.1")	SSM-1400	1400 mm (55.1")	1511 mm (59.5")	1478 mm (58.2")
1500 mm (59.0")	SSM-1550	1550 mm (61.0")	1661 mm (65.4")	1628 mm (64.1")
1650 mm (65.0")	SSM-1750	1750 mm (68.9")	1861 mm (73.3")	1828 mm (72.0")
1800 mm (70.9")	SSM-1900	1900 mm (74.8")	2011 mm (79.2")	1978 mm (77.9")

*Stainless steel reflective surface models also available by adding model number suffix "-S" (e.g., **SSM-200-S**); range reduction for these models is approximately 30% per mirror. See data sheet p/n 67200.

Accessory Mounting Brackets

See Section 2.5 for standard brackets. Contact factory for more information. Order one EZA-MBK-.. bracket per sensor, two per pair.

Model		Description
EZA-MBK-2		Adapter bracket for mounting SSM series mirror to MSA series stands
EZA-MBK-20		<ul style="list-style-type: none"> • Universal adapter bracket for mounting to engineered/slotted aluminum framing (e.g., 80/20™, Unistrut™). • Retrofit for Banner MS/US/MG.
EZA-MBK-21		<p>Mounting bracket system for "L" configuration of two cascaded light screens. Order one per side. See Figure 7-1, data sheet p/n 121007, or contact factory for more information.</p> <p>NOTE: Special end brackets included, but not shown.</p>
EZA-MBK-8		Retrofit for Sick FGS and Leuze L-bracket
EZA-MBK-13		Retrofit for Sick C4000, AB SafeShield/GuardShield, Omron FS3N, STI MC42/47
EZA-MBK-14		Retrofit for STI MS4300
EZA-MBK-15		Retrofit for STI MS46/47, Keyence PJ-V, SUNX SF4-AH
EZA-MBK-18		Retrofit for Dolan-Jenner SS7

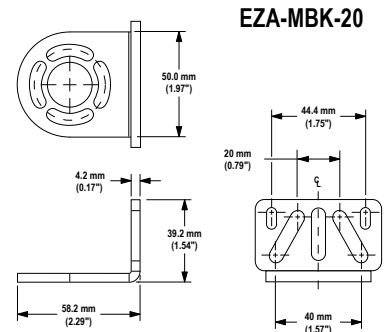









Alignment Aids

Model	Description
LAT-1-SS	Self-contained visible-beam laser tool for aligning any EZ-SCREEN 14 mm and 30 mm emitter/receiver pair. Includes retroreflective target material and mounting clip.
EZA-LAT-SS	Replacement adaptor (clip) hardware for SLS.. models
EZA-LAT-2	Clip-on retroreflective LAT target
BRT-THG-2-100	2" retroreflective tape, 100'
BT-1	Beam Tracker

EZ-LIGHT™ for EZ-SCREEN®

Provides clear, 360° indication of the EZ-SCREEN receiver's output status. Use with a CSB splitter cable and optional DEE2R double-ended cables (see page 9). See data sheet 121901 for more information.

Models	Construction	Connector	LED Function	Inputs
 M18RGX8PQ8 (See Note below*)	Nickel-plated brass housing, thermoplastic dome, M18x1 thread mount Fully encapsulated, IP67	8-pin Euro-style integral QD	Red/Green indication follows OSSD output of the EZ-SCREEN receiver ON Red: Power ON Beam Blocked or Lockout ON Green: Power ON Beam Clear	PNP (Sourcing)
 T18RGX8PQ8	Thermoplastic polyester housing, thermoplastic dome, 18 mm mount Fully encapsulated, IP67			
 T30RGX8PQ8	Thermoplastic polyester housing, thermoplastic dome, 30 mm mount Fully encapsulated, IP67			
 K30LRGX8PQ8	Polycarbonate housing, 30 mm thermoplastic dome, 22 mm mount Fully encapsulated, IP67			
 K50LRGX8PQ8	Polycarbonate housing, 50 mm thermoplastic dome, 30 mm mount Fully encapsulated, IP67			
 K80LRGX8PQ8	Polycarbonate housing, 50 mm thermoplastic dome, flat or DIN mount Encapsulated electronics, IP67			

*Available in a kit that includes one M18 EZ-LIGHT, one SMB18A mounting bracket, and hardware for mounting to the side channel of an EZ-SCREEN housing (kit model number EZA-M18RGX8PQ8).

2.5 Replacement Parts

Description		Model Number
Panel-mount keyed reset switch		MGA-KSO-1
Replacement key for switch MGA-KSO-1		MGA-K-1
Access cover with label – emitter		EZA-ADE-1
Access cover with label – receiver		EZA-ADR-1
Access cover with inverted label – emitter		EZA-ADE-2
Access cover with inverted label – receiver		EZA-ADR-2
Access cover security plate (includes 2 screws, wrench)		EZA-TP-1
Wrench, security		EZA-HK-1
14 mm test piece (for 14 mm resolution systems)		STP-13
30 mm test piece (for 14 mm resolution systems with 2-beam Reduced Resolution and for 30 mm resolution systems)		STP-14
60 mm test piece (for 30 mm resolution systems with 2-beam Reduced Resolution)		STP-15
Terminator plug for cascaded receiver		EZA-RTP-1
Dust cap for cascaded emitter		p/n 64790
Standard bracket kit with hardware (includes 2 end brackets and hardware to mount to MSA Series stands; see Figure 2-1)	Black	EZA-MBK-11
	Stainless Steel	EZA-MBK-11N
Center bracket kit (includes 1 bracket and hardware to mount to MSA Series stands), and retrofit for SICK and Leuze Swivel (see Figure 2-1)		EZA-MBK-12
SSM Mirror bracket kit (includes 2 replacement brackets for one mirror)		SMA-MBK-1



2.6 Literature

The following documentation is supplied with each EZ-SCREEN receiver. Additional copies are available at no charge.

Description	Part #
EZ-SCREEN System Instruction Manual	112852
Checkout Procedure Card (Daily) – Stand-Alone Systems	113361
Checkout Procedure Card (Daily) – Cascaded Systems	118173
Checkout Procedure Card (Semi-Annual)	113362
Diagnostic Display Label	114189

2.7 Specifications

2.7.1 General Specifications

Short Circuit Protection	All inputs and outputs are protected from short circuits to +24V dc or dc common.
Electrical Safety Class (IEC 61140: 1997)	III
Safety Rating	Type 4 per IEC 61496-1, -2; Category 4 PL e, per EN ISO 13849-1; SIL 3 per IEC 61508; SIL CL 3 per IEC 62061
Resolution† and Operating Range	<p>14 mm models: 0.1 m to 6 m (4" to 20')</p> <p>30 mm models: 0.1 m to 18 m (4" to 60')</p> <p>Range decreases with use of mirrors and/or lens shields: Lens shields – approximately 10% less range per shield. Glass-surface mirrors – approximately 8% less range per mirror. See the specific mirror data sheet or the Banner Safety Catalog for further information.</p>
†Not including blanking	
Effective Aperture Angle (EAA)	Meets Type 4 requirements per IEC 61496-2, Section 5.2.9 ± 2.5° @ 3 m
Enclosure	<p>Size: See Figure 2-2</p> <p>Materials: Extruded aluminum housing with yellow polyester powder finish standard (optional black or white or nickel-plated silver finish) and well-sealed, rugged die-cast zinc end caps, acrylic lens cover, copolyester access cover. End caps on silver models are also nickel-plated. ESD-safe models have static-dissipative acrylic lens cover.</p> <p>Rating: IEC IP65</p>
Operating Conditions	<p>Temperature: 0° to +55° C (+32° to 131°F)</p> <p>Max. Relative Humidity: 95% maximum relative humidity (non-condensing)</p>
Shock and Vibration	EZ-SCREEN components have passed vibration and shock tests according to IEC 61496-1. This includes vibration (10 cycles) of 10-55 Hz at 0.35 mm (0.014") single amplitude (0.70 mm peak-to-peak) and shock of 10 g for 16 milliseconds (6,000 cycles).
Mounting Hardware	Emitter and receiver each are supplied with a pair of swivel end-mounting brackets. Models longer than 900 mm also include a swivel center-mount bracket. Mounting brackets are 8-gauge cold-rolled steel, black zinc finish.
Cables and Connections	See Section 2.3 for recommended QD cables. If other cables are used with the EZ-SCREEN, the user must verify suitability of these cables for each application.
Certifications	 IEC 61496-1, -2: Type 4 EN ISO 13849-1: Cat 4 PL e  NIPF(7) UL1998, UL61496

2.7.2 Emitter Specifications

Supply Voltage at the Device	24V dc \pm 15% (use a SELV-rated supply according to EN IEC60950) (The external voltage supply must be capable of buffering brief mains interruptions of 20 ms, as specified in IEC/EN 60204-1.)
Residual Ripple	\pm 10% maximum
Supply Current	100 mA max.
Remote Test Input (Optional – available only on model SLSE...Q5 emitters)	Test mode is activated either by applying a low signal (less than 3V dc) to emitter TEST #1 terminal for a minimum of 50 milliseconds, or by opening a switch connected between TEST #1 and TEST #2 for a minimum of 50 milliseconds. Beam scanning stops to simulate a blocked condition. A high signal at TEST #1 deactivates Test Mode. (See Section 3.5.6 for more information.) High Signal: 10 to 30V dc Low Signal: 0 to 3V dc Input Current: 35 mA inrush, 10 mA max.
Controls and Adjustments	Scan Code Selection: 2-position switch (code 1 or 2). Factory default position is code 1.
Status Indicators	One bi-color (Red/Green) Status indicator – indicates operating mode, lockout or power OFF condition 7-Segment Diagnostic indicator (1 digit) – indicates proper operation, scan code, or error code See Figure 1-4 for indicator locations and Section 4.4 for indicator conditions.
Wavelength of Emitter Elements	Infrared LEDs, 950 nm at peak emission (14 mm) 850 nm at peak emission (30 mm)

2.7.3 Receiver Specifications

Supply Voltage at the Device	24V dc \pm 15% (use a SELV-rated supply according to EN IEC60950) (The external voltage supply must be capable of buffering brief mains interruptions of 20 ms, as specified in IEC/EN 60204-1.)		
Residual Ripple	\pm 10% maximum		
Supply Current (no load)	275 mA max., exclusive of OSSD1 and OSSD2 loads (up to an additional 0.5A each)		
Response Time	Dependent on number of sensing beams (see Section 2.1 for models and number of beams):		
	10 beams – 9 ms	60 beams – 19 ms	110 beams – 30 ms
	20 beams – 11 ms	70 beams – 21 ms	120 beams – 32 ms
	30 beams – 13 ms	80 beams – 23 ms	130 beams – 34 ms
	40 beams – 15 ms	90 beams – 25 ms	140 beams – 36 ms
	50 beams – 17 ms	100 beams – 27 ms	150 beams – 38 ms
	160 beams – 40 ms	180 beams – 43 ms	200 beams – 48 ms
	220 beams – 52 ms	240 beams – 56 ms	
	For cascaded systems, also see Section 7.4.		
CSSI Response Time (SLSC.. cascade models only)	Response time for a cascade receiver due to opening contacts at the cascade interface (CSSI): 40 ms max (contacts must open for 60 ms minimum). See Section 7.5.		
Recovery Time — Blocked to Clear (OSSDs turn ON; varies with total number of sensing beams and whether Sync beam is blocked)		Beam 1 (Sync Beam)	All Other Beams
	14 mm Models	109 ms to 800 ms	33 ms to 220 ms
	30 mm Models	81 ms to 495 ms	25 ms to 152 ms
EDM Input	+24V dc signals from external device contacts can be monitored (one-channel, two-channel or no monitoring) via EDM1 and EDM2 terminals in the receiver (see Section 3.5.3). High Signal: 10 to 30V dc at 30 mA typical Low Signal: 0 to 3V dc Dropout Time: 200 ms max.		
Reset Input	The Reset input must be high for 1/4 to 2 seconds and then low to reset the receiver. High Signal: 10 to 30V dc at 30 mA typical Low Signal: 0 to 3V dc Closed Switch Time: 1/4 to 2 seconds		

2.7.3 Receiver Specifications, continued

<p>Output Signal Switching Devices (OSSDs)</p>	<p>Two redundant solid-state 24V dc, 0.5 A max. sourcing OSSD (Output Signal Switching Device) safety outputs. (Use optional interface modules for ac or larger dc loads.) Capable of the Banner "Safety Handshake" (see Section 1.1). ON-State voltage: $\geq V_{in}-1.5V$ dc OFF-State voltage: 1.2V dc max. (0-1.2V dc) Max. load capacitance: 1.0 μF Max. load inductance: 10 H Leakage Current: 0.50 mA maximum Cable Resistance: 10 Ω maximum OSSD test pulse width: 100 to 300 microseconds OSSD test pulse period: 10 ms to 27 ms (varies with number of beams) Switching Current: 0-0.5 A</p>
<p>Auxiliary (Aux.) Output Switching Capacity</p>	<p>Current-sourcing (PNP) solid-state output, 24V dc at 75mA max (see Section 3.5.5).</p>
<p>Controls and Adjustments</p>	<p>Scan Code selection: 2-position switch (code 1 or 2). Factory default position is code 1. Trip/Latch Output selection: Redundant switches. Factory default position is T (trip). EDM/MPCE monitor selection: 2-position switch selects between 1- or 2-channel monitoring. Factory default position is 2. Reduced Resolution: Redundant switches. Factory default position is OFF.</p>
<p>Ambient Light Immunity</p>	<p>> 10,000 lux at 5° angle of incidence</p>
<p>Strobe Light Immunity</p>	<p>Totally immune to one Federal Signal Corp. "Fireball" model FB2PST strobe</p>
<p>Status Indicators</p>	<p>Yellow Reset indicator – indicates whether system is ready for operation or requires a reset Bi-color (Red/Green) Status indicator – indicates general system and output status Bi-color (Red/Green) Zone Status indicators – indicate condition (clear or blocked beam) of a defined group of beams 7-Segment Diagnostic indicator (3 digits) – indicates proper operation, scan code, or error code, total number of blocked beams See Figure 1-4 for indicator locations and Section 4.4 for indicator conditions.</p>

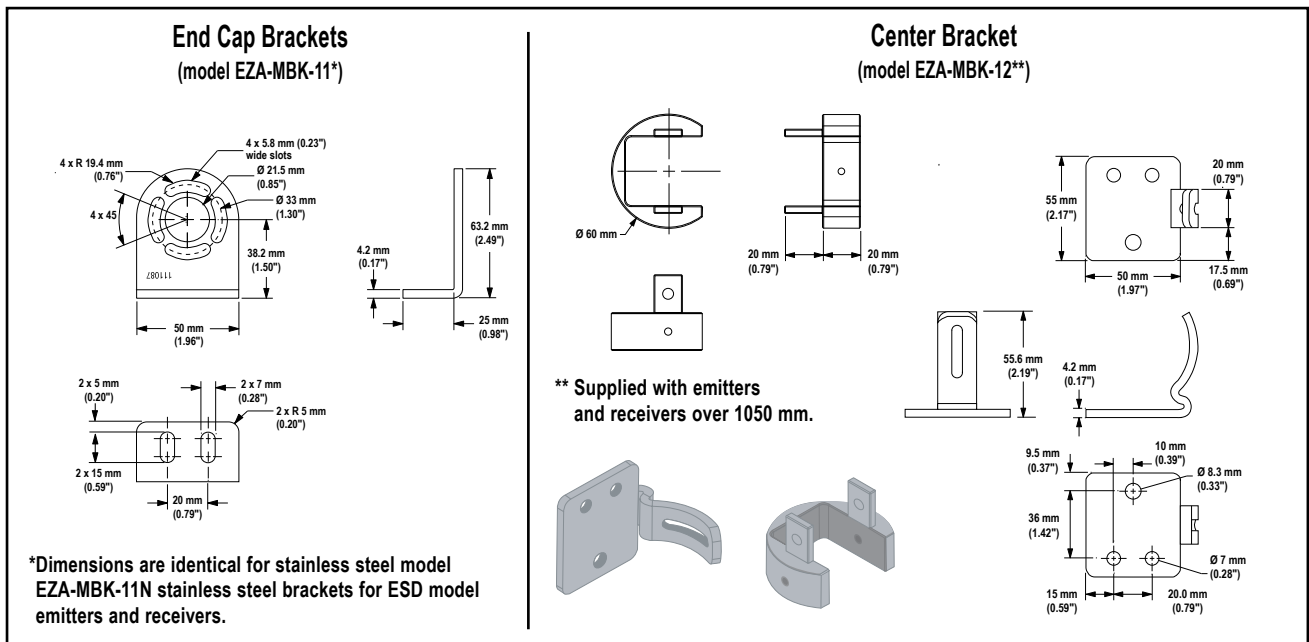

Figure 2-1. Included mounting bracket dimensions (for emitter or receiver)

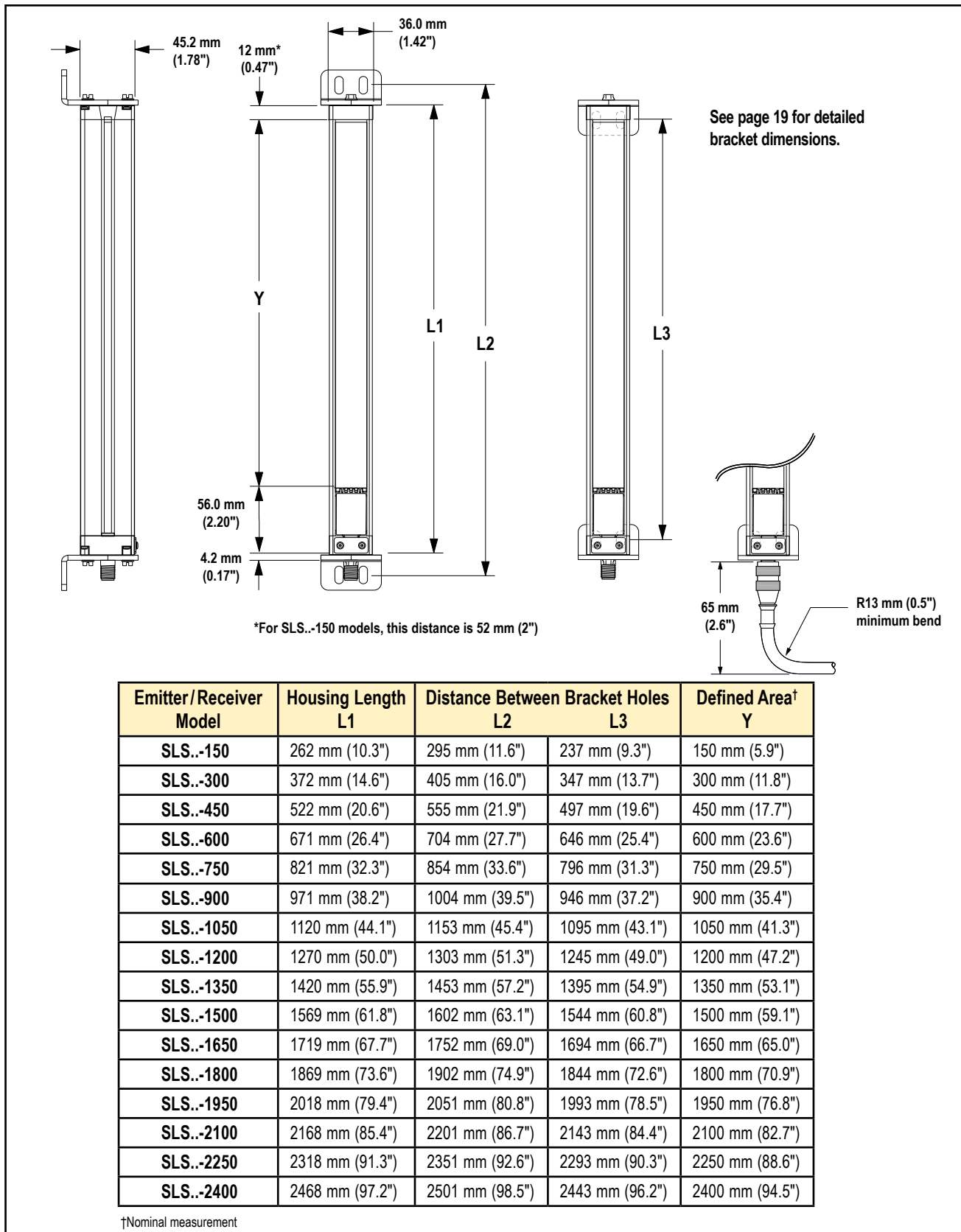

Figure 2-2. Emitter and receiver mounting dimensions and location of defined area

3. Installation and Alignment

Before installing the EZ-SCREEN System, read Section 1.2 and Section 3 of this manual in their entirety. The System's ability to perform its safety guarding function depends upon the appropriateness of the application and upon its proper mechanical and electrical installation and interfacing to the guarded machine. If all mounting, installation, interfacing, and checkout procedures are not followed properly, the System cannot provide the protection for which it was designed. Installation must be performed by a Qualified Person, as defined in Section 4.1. See Warning below.

⚠ WARNING . . . Read this Section Carefully Before Installing the System

The user is responsible for satisfying all local, state, and national codes and regulations relating to the installation and use of this control system in any particular application. Take extreme care to meet all legal requirements and follow all technical installation and maintenance instructions contained in this manual.

The user has the sole responsibility to ensure that the EZ-SCREEN System is installed and interfaced to the guarded machine by Qualified Persons in accordance with this manual and with applicable safety regulations.

Read Section 1.2 and all of Section 3 of this manual carefully before installing the system. Failure to follow these instructions could result in serious bodily injury or death.

3.1 Mechanical Installation Considerations

The two factors that influence the layout of the EZ-SCREEN's mechanical installation the most are separation distance and hard guarding. Other considerations include emitter and receiver orientation, adjacent reflective surfaces, use of corner mirrors, and installation of multiple EZ-SCREEN emitter/receiver pairs.

⚠ WARNING . . . Position Components Carefully

The emitter and receiver must be positioned such that the hazard can not be accessed by reaching over, under, around or through the sensing field. Additional guarding may be required; see Separation Distance, Section 3.1.1, and Pass-Through Hazards, Section 3.1.2, and Supplemental Safeguarding, Section 3.1.4.

3.1.1 Separation Distance (Safety Distance)

Minimum Separation Distance (D_s) is the minimum distance required between the defined area and the closest reachable hazard point. Separation distance is calculated so that when an object or a person is detected (by blocking a sensing beam), the EZ-SCREEN will send a stop signal to the machine, causing it to stop by the time the person can reach any machine hazard point.

Calculation of separation distance takes into account several factors, including a calculated human speed, the total system stopping time (which itself has several components), and the depth penetration factor. After the separation distance (D_s) is determined, record the calculated distance on the Daily Checkout Card.

⚠ WARNING . . . Proper Separation Distance

Banner EZ-SCREEN emitters and receivers must be mounted at a distance from the nearest hazard such that an individual cannot reach the hazard before cessation of hazardous motion or situation. Failure to establish and maintain the minimum separation distance could result in serious bodily injury or death.

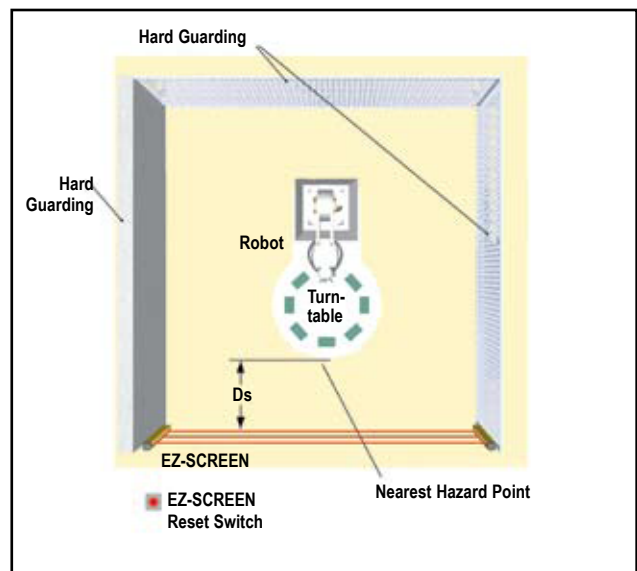

Figure 3-1. Separation distance and hard guarding

The formula used for U.S. applications (other standards may apply) to calculate separation distance is:

$$D_s = K \times (T_s + T_r) + D_{pf}$$

where:

- D_s** – the separation distance, in mm (inches);
- K** – 1600 mm per second (or 63" per second), the OSHA1910.217, ANSI B11, ANSI/RIA R15.06 recommended hand-speed constant (See Note 1);
- T_s** – the overall stop time of the machine (in seconds) from the initial "stop" signal to the final ceasing of all motion, including stop times of all relevant control elements (e.g., IM-T.. Interface Modules) and measured at maximum machine velocity (See Note 2 and Warning at right).
- T_r** – the maximum response time, in seconds, of the EZ-SCREEN emitter/receiver pair (see Section 2.1 for SLS.. models and Section 7.5 for SLSC.. models); and
- D_{pf}** – the added distance due to depth penetration factor as prescribed in OSHA1910.217, ANSI B11, ANSI/RIA R15.06 for U.S. applications (See Caution below):

Reduced Resolution	Depth Penetration Factor (Dpf)	
	14 mm Systems	30 mm Systems
OFF	24 mm (1")	78 mm (3")
ON	78 mm (3")	180 mm (7")

NOTES:

1. The OSHA-recommended hand speed constant K has been determined by various studies, and although these studies indicate speeds of 63"/second to more than 100"/second, they are not conclusive determinations. Consider all factors, including the physical ability of the operator, when determining the value of K to be used.
2. T_s is usually measured by a stop-time measuring device. If the machine manufacturer's specified stop time is used, at least 20% should be added to allow for possible clutch/brake system deterioration. This measurement must take into account the slower of the two MPCE channels, and the response time of all devices or controls that react to stop the machine. See Notice Regarding MPCEs. **If all devices are not included, the calculated separation distance (D_s) will be too short and serious injury could result.**

⚠ WARNING . . . Proper Installation When Using Reduced Resolution

Reduced Resolution increases Dpf (see values in table). **Increase the depth penetration factor to calculate the proper separation distance whenever Reduced Resolution is used.** Always turn Reduced Resolution OFF when the larger minimum object detection size is not required.

⚠ WARNING . . . Determine Correct Stop Time

Stop time (T_s) must include the response time of all devices or controls that react to stop the machine. If all devices are not included, the calculated safety distance (D_s) will be too short. This can lead to serious bodily injury or death. **Be sure to include the stop time of all relevant devices and controls in your calculations.**

Notice Regarding MPCEs

Each of the two Machine Primary Control Elements (MPCE1 and MPCE2) must be capable of immediately stopping the dangerous machine motion, irrespective of the state of the other. These two channels of machine control need not be identical, but the stop time performance of the machine (T_s, used to calculate the separation distance) must take into account the slower of the two channels (see Section 3.5.3).

This example shows how to use the formula at left to calculate separation (safety) distance (D_s). These numbers will be used for the variables in the formula:

K = 63" per second (the hand speed constant set by OSHA)

T_s = 0.32 (0.250 second is specified by the machine manufacturer; plus 20% safety factor; plus 20 ms for interface module IM-T-9A response)

T_r = 0.023 second (the specified response time of an SLSP14-600 EZ-SCREEN System)

Our example uses a 600 mm system with 14 mm resolution and Reduced Resolution ON, so D_{pf} is 3". Response time for this example is 0.023 second.

Substitute the numbers into the formula as follows:

$$D_s = K \times (T_s + T_r) + D_{pf}$$

$$D_s = 63 \times (0.32 + 0.023) + 3 = 24.6"$$

In this example, the EZ-SCREEN emitter and receiver must be mounted so that no part of the defined area will be closer than 24.6" to the closest reachable hazard point on the guarded machine.

Figure 3-2. Separation Distance (D_s) calculation example

3.1.2 Pass-Through Hazards

A “pass-through hazard” is associated with applications where personnel may pass through a safeguard (which issues a stop command to remove the hazard), and then continues into the guarded area, such as in perimeter guarding. Subsequently, their presence is no longer detected, and the related danger becomes the unexpected start or restart of the machine while personnel are within the guarded area.

In the use of safety light screens, a pass-through hazard typically results from large separation distances calculated from long stopping times, large minimum object sensitivities, reach-over, reach-through, or other installation considerations. A pass-through hazard can be generated with as little as 75 mm (3") between the defined area and the machine frame or hard guarding.

Reducing or Eliminating Pass-Through Hazards

Eliminate or reduce pass-through hazards whenever possible. While it is recommended to eliminate the pass-through hazard altogether, this may not be possible due to machine layout, machine capabilities, or other application considerations.

One solution is to ensure that personnel are continually sensed while within the hazardous area. This can be accomplished by using supplemental safeguarding, such as described by the ANSI B11 series of safety requirements or other appropriate standards (see Section 3.1.4).

An alternate method is to ensure that once the safeguarding device is tripped it will latch, and will require a deliberate manual action to reset. This method of safeguarding relies upon the location of the reset switch as well as safe work practices and procedures to prevent an unexpected start or restart of the guarded machine (see Section 3.1.3).

WARNING . . . Use of EZ-SCREEN for Perimeter Guarding

If an EZ-SCREEN System is installed in an application that results in a pass-through hazard (e.g., perimeter guarding), either the EZ-SCREEN System or the Machine Primary Control Elements (MPCEs) of the guarded machine must cause a Latched response following an interruption of the defined area.

The reset of this Latched condition may only be achieved by actuating a reset switch that is separate from the normal means of machine cycle initiation. The switch must be positioned as described in Section 3.1.3.

Lockout/Tagout procedures per ANSI Z244.1 may be required, or additional safeguarding, as described by ANSI B11 safety requirements or other appropriate standards, must be used if a pass-through hazard can not be eliminated or reduced to an acceptable level of risk. **Failure to observe this warning could result in serious bodily injury or death.**

3.1.3 Reset Switch Location

The reset switch must be mounted at a location that complies with the warning below.

A key-actuated reset switch provides some operator or supervisory control, as the key can be removed from the switch and taken into the guarded area. However, this does not prevent unauthorized or inadvertent resets due to spare keys in the possession of others, or additional personnel entering the guarded area unnoticed.

Resetting a safeguard must not initiate hazardous motion.

Safe work procedures require a start-up procedure to be followed and the individual performing the reset to verify that the entire hazardous area is clear of all personnel, *before each reset of the safeguard is performed*. If any area can not be observed from the reset switch location, additional supplemental safeguarding must be used: at a minimum, visual and audible warnings of machine start-up.

WARNING . . . Reset Switch Location

All reset switches must be:

- Outside the guarded area,
- Located to allow the switch operator full, unobstructed view of the entire guarded area while the reset is performed,
- Out of reach from within the guarded area, and
- Protected against unauthorized or inadvertent operation (such as through the use of rings or guards).

If any areas within the guarded area are **not visible** from the reset switch, **additional safeguarding must be provided**, as described by the ANSI B11 series or other appropriate standards. **Failure to do so could result in serious injury or death.**

3.1.4 Supplemental Safeguarding

As described in Section 3.1.1, the EZ-SCREEN components must be properly positioned such that an individual can not reach through the defined area and access the hazard point before the machine has stopped.

Additionally, the hazard can not be accessible by reaching around, under, or over the defined area. To accomplish this, supplemental guarding (mechanical barriers, such as screens or bars), as described by ANSI B11 safety requirements or other appropriate standards, must be installed. Access will then be possible only through the defined area of the EZ-SCREEN or through other safeguarding that prevents access to the hazard (see Figure 3-3).

The mechanical barriers used for this purpose are typically called “hard guarding”; there must be no gaps between the hard guarding and the defined area. Any openings in the hard guarding must comply with the safe opening requirements of ANSI B11 or other appropriate standard.

⚠ WARNING . . . The Hazard Must Be Accessible Only through the Defined Area

The installation of the EZ-SCREEN must prevent any individual from reaching around, under, over or through the defined area and into the hazard without being detected. Mechanical barriers (e.g., hard guarding) or supplemental safeguarding may be required to comply with this requirement, and is described by ANSI B11 safety requirements or other appropriate standards.

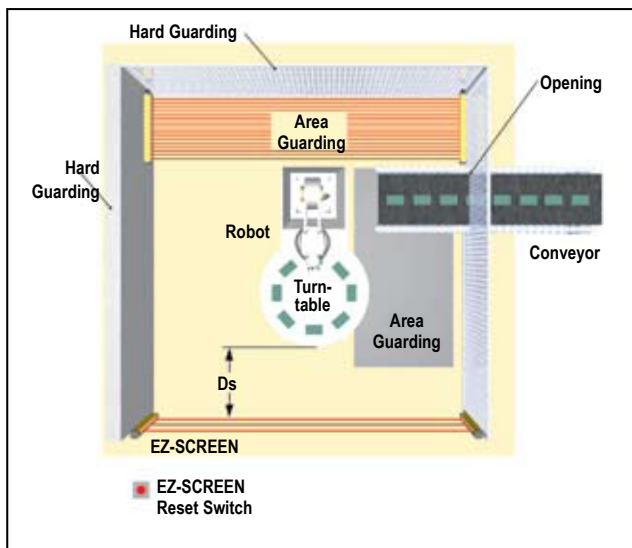

Figure 3-3. An example of supplemental safeguarding

Figure 3-3 shows an example of supplemental safeguarding inside a robotic work cell. The EZ-SCREEN, in conjunction with the hard guarding, is the primary safeguard. Supplemental safeguarding (such as a horizontal-mounted safety light screen as an area guard) is required in areas that can not be viewed from the reset switch (i.e., behind the robot and the conveyor). Additional supplemental safeguarding may be required to prevent clearance or trapping hazards (e.g., the safety mat as an area guard between the robot, the turntable, and the conveyor).

⚠ WARNING . . . Proper Orientation of EZ-SCREEN Emitters and Receivers

EZ-SCREEN emitters and receivers must be installed with their corresponding cabled ends pointing in the same direction (e.g., both cabled ends “up”). Failure to orient them properly will impair the performance of the EZ-SCREEN and will result in incomplete guarding, and could result in serious bodily injury or death.

3.1.5 Emitter and Receiver Orientation

The emitter and receiver must be mounted parallel to each other and aligned in a common plane, with both cable ends pointing in the same direction. **Never mount the emitter with its cable end oriented opposite the cable end of the receiver. If this occurs, voids in the light screen may allow objects or personnel to pass through the defined area undetected** (see Figure 3-4).

The emitter and receiver may be oriented in a vertical or horizontal plane, or at any angle between horizontal and vertical, as long as they are parallel and their cable ends point in the same direction. Verify that the light screen completely covers all access to the hazard point that is not already protected by hard guarding or other supplemental guarding.

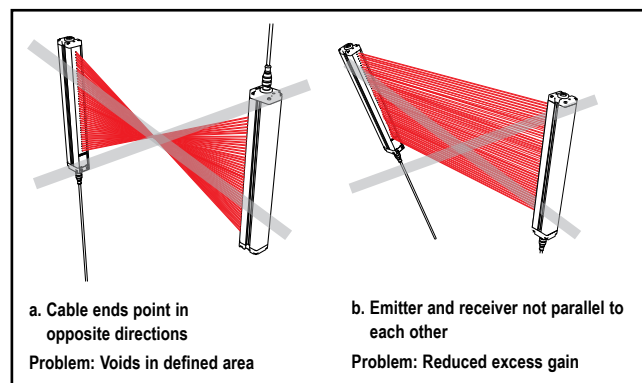

Figure 3-4. Examples of incorrect emitter / receiver orientation

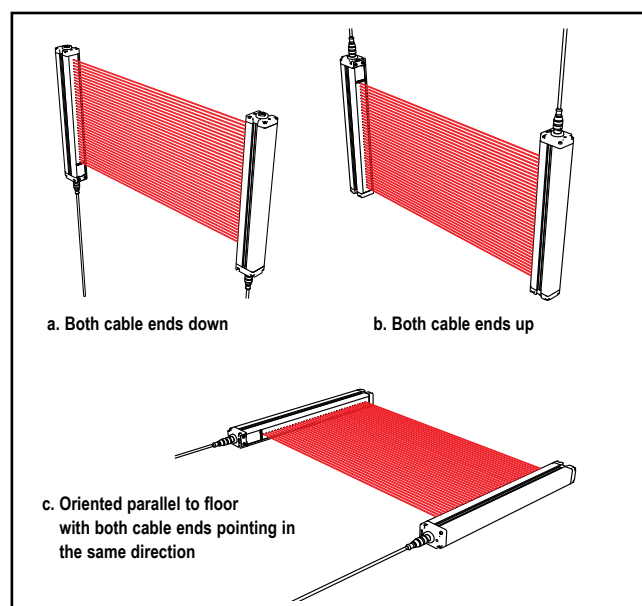

Figure 3-5. Examples of correct emitter / receiver orientation

3.1.8 Installation of Multiple Systems

Whenever two or more EZ-SCREEN emitter and receiver pairs are adjacent to one another, optical crosstalk may potentially take place between systems. To minimize optical crosstalk, alternate the positions of emitters and receivers, (see Figure 3-8a), or alternate Scan Codes.

When three or more sensor pairs are installed in the same plane (as shown for two pairs in Figure 3-8), optical crosstalk may occur between sensor pairs whose emitter and receiver lenses are oriented in the same direction. In this situation, eliminate optical crosstalk by mounting these sensor pairs exactly in line with each other within one plane, or by adding a mechanical barrier between the pairs.

To further aid in avoiding crosstalk, the sensors feature two selectable Scan Codes. A receiver set to one Scan Code will not "see" an emitter set to another code (see Section 4.2).

WARNING . . . Scan Code

In situations where multiple systems are mounted closely together, or where a secondary emitter is in view (within $\pm 5^\circ$), within range of an adjacent receiver; the adjacent systems must be configured for different Scan Codes (i.e., one system set for Scan Code 1 and the other for Scan Code 2).

If not, a receiver may synchronize to the signal from the wrong emitter, reducing the safety function of the light screen.

This situation will be discovered by performing the trip test (see Section 3.4.3).

WARNING . . . Multiple Pairs of Sensors

Do not connect multiple pairs of sensors to one Interface Module (e.g., IM-T-9A/-11A) or otherwise parallel OSSD outputs.

Connection of multiple OSSD safety outputs to a single device can result in serious bodily injury or death, and is prohibited.

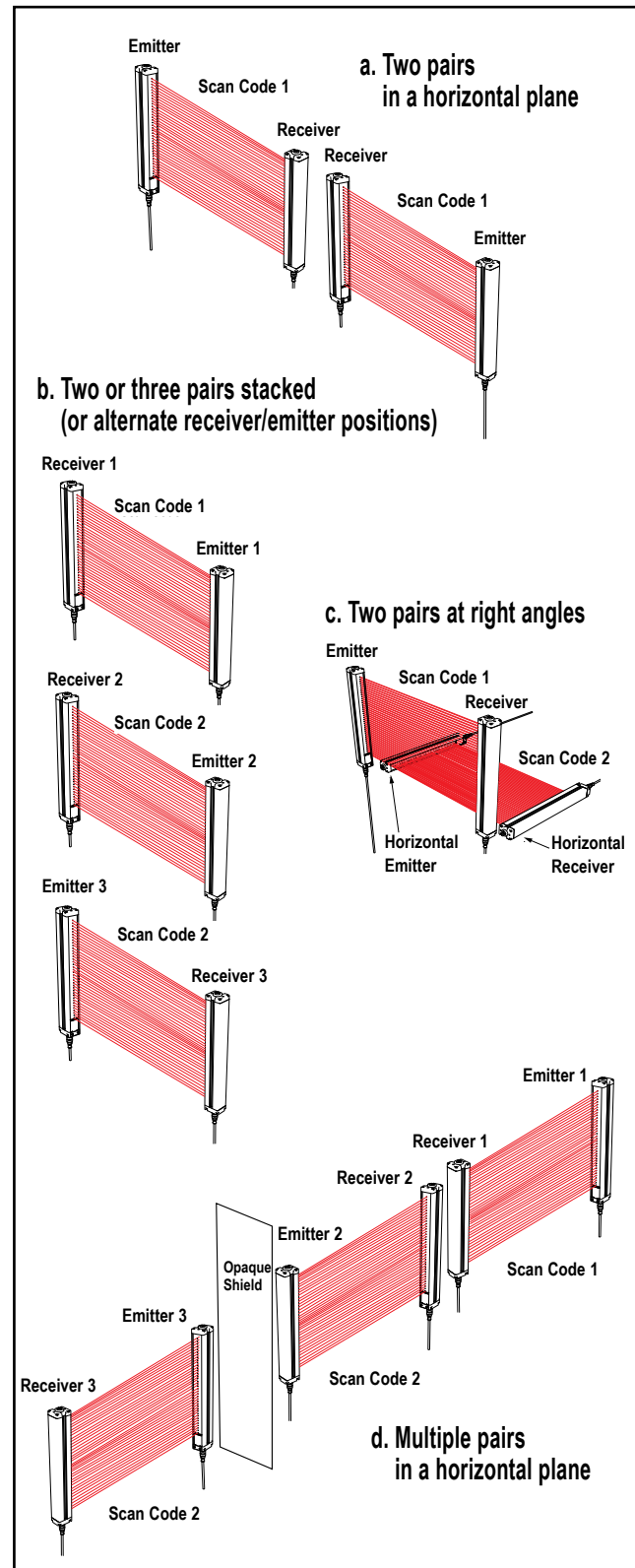

Figure 3-8. Installation of multiple pairs; alternate emitters and receivers to avoid optical crosstalk.

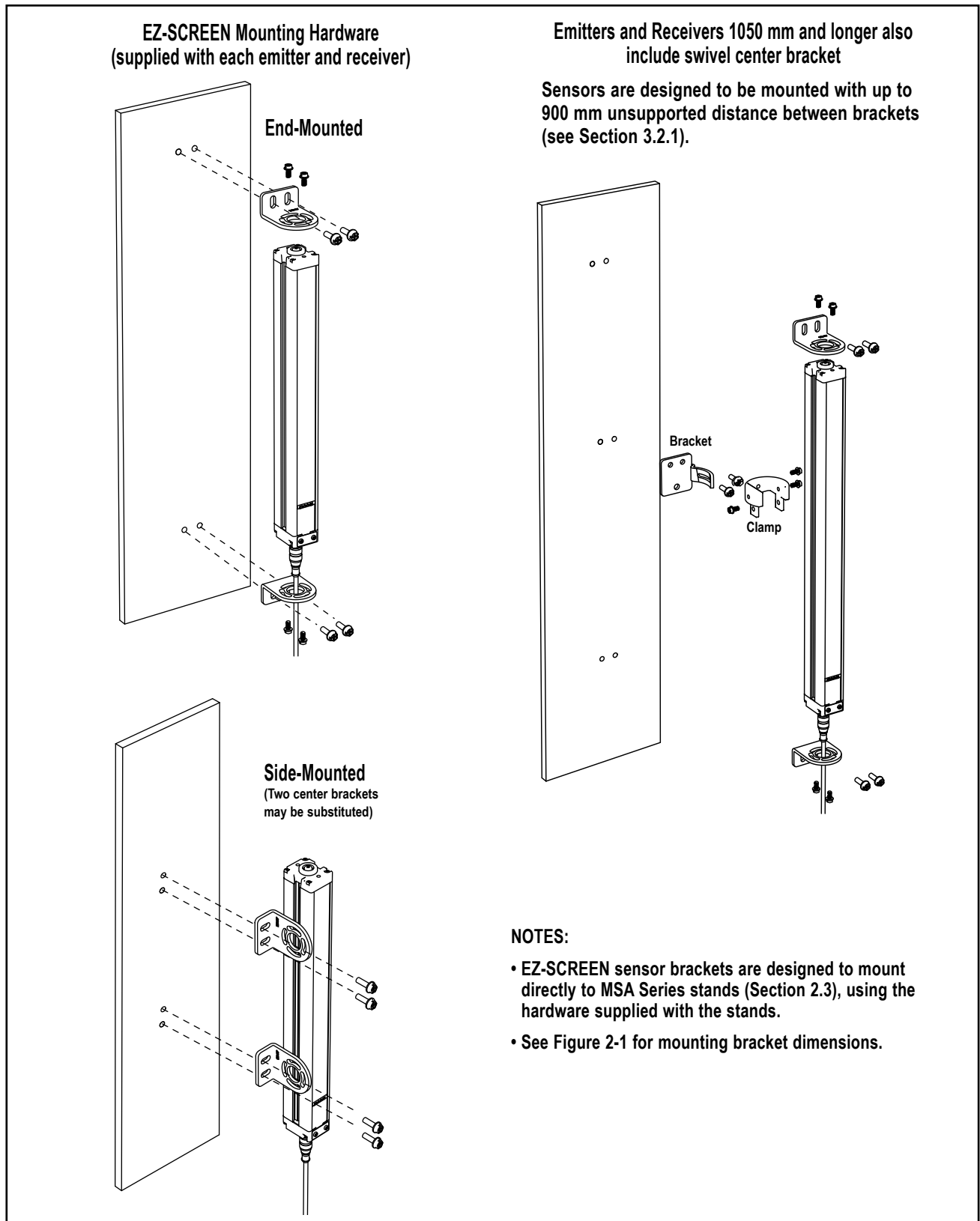

Figure 3-9. Emitter and receiver mounting hardware

3.2 Mechanical Mounting Procedure

Once the mechanical layout considerations of Section 3.1 are addressed, mount the sensors and route the cables.

3.2.1 Sensor Mounting

Emitter/receiver pairs with 14 mm (0.55") resolution may be spaced from 0.1 m to 6 m (4" to 20') apart. Emitter/receiver pairs with 30 mm (1.18") resolution may be spaced from 0.1 m to 18 m (4" to 60') apart. The maximum distance between an emitter and its receiver is reduced if corner mirrors are used (see Section 3.1.7). The supplied brackets (when mounted to the sensor end caps) allow $\pm 30^\circ$ rotation.

From a common point of reference (ensuring the minimum separation distance calculated in Section 3.1.1), make measurements to locate the emitter and receiver in the same plane with their midpoints directly opposite each other.

Important: The connector ends of both sensors must point in the same direction (see Figure 3-5 and warning, Section 3.1.3). Mount the emitter and receiver mounting brackets (see below) using the supplied M6 bolts and Keps nuts, or user-supplied hardware; see Figure 3-9.

Mount the emitter and receiver in their brackets; position their windows directly facing each other. Measure from a reference plane (e.g., a level building floor) to the same point(s) on the emitter and receiver to verify their mechanical alignment. Use a carpenter's level, a plumb bob, or the optional LAT-1 Laser Alignment Tool (see Section 2.5) or check the diagonal distances between the sensors, to achieve mechanical alignment. Final alignment procedures are explained in Section 3.4.

Center mounting brackets must be used with longer sensors, whenever the sensors are subject to shock or vibration. In such situations, the sensors are designed to be mounted with up to 900 mm unsupported distance (between brackets). Sensors 1050 mm and longer are supplied with a center bracket to be used as needed with the standard end-cap brackets (see Figure 3-9).

1. Attach the center bracket to the mounting surface when mounting the end-cap brackets.
2. Attach the clamp to both slots of the housing, using the included M5 screws and T-nuts.
3. After the sensor is mounted to the end-cap brackets, attach the clamp to the center bracket using the supplied M5 screw.

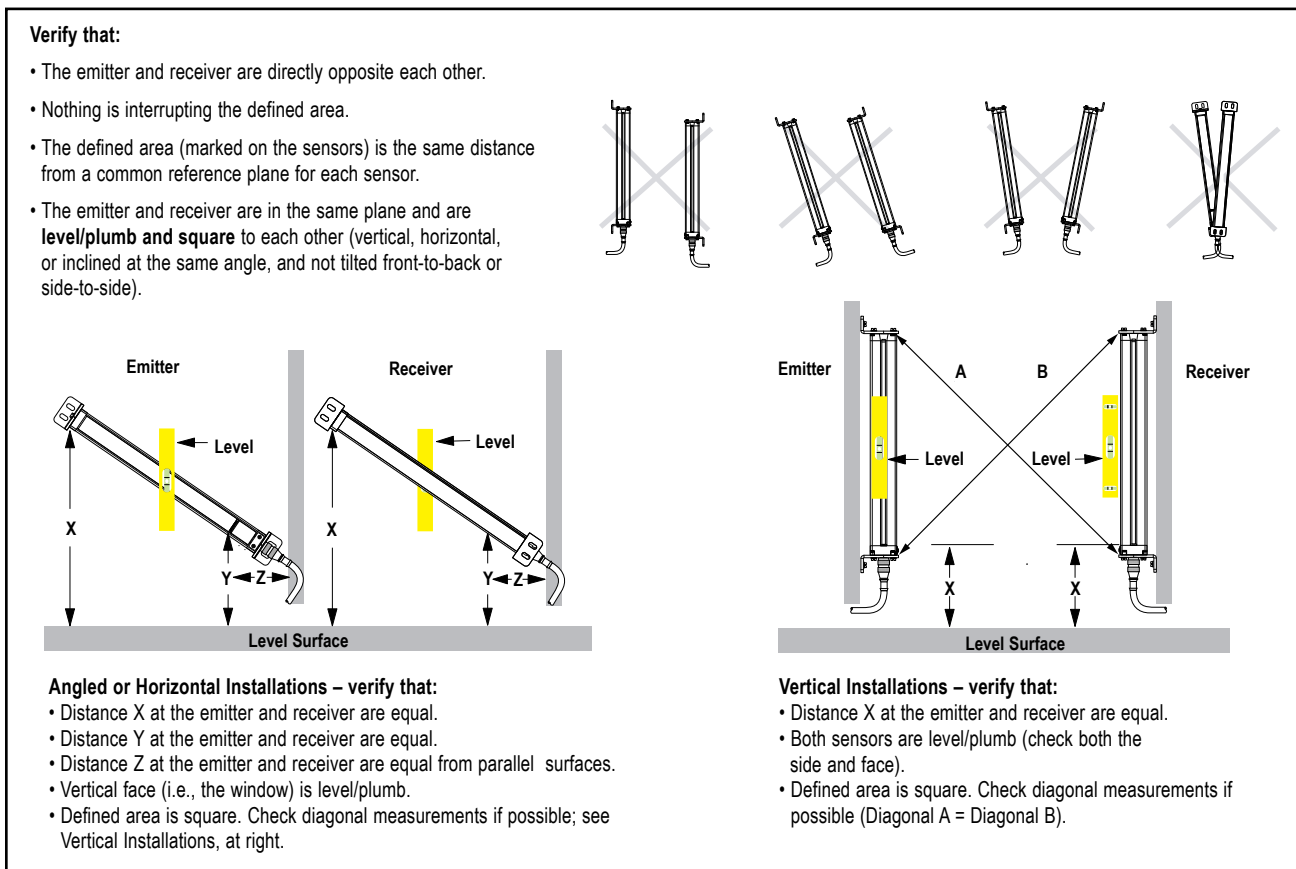

Figure 3-10. Sensor mounting, mechanical alignment

3.2.2 Mounting the Reset Switch

Mount the reset switch in a location that complies with the warning in Section 3.1.3. See Section 3.3.2 for electrical connection.

3.2.3 Routing Cables

Connect the QD connectors and route the sensor cables to the junction box, electrical panel, or other enclosure in which the Interface Module, the redundant mechanically linked interposing relays, FSDs, or other safety-related parts of the control system are located. This must be done per local wiring code for low-voltage dc control cables and may require installation of electrical conduit. See Section 2.2 for selection of Banner-supplied cables.

EZ-SCREEN is designed and manufactured to be highly resistant to electrical noise and to operate reliably in industrial settings. However, extreme electrical noise may cause a random Trip or Latch condition; in extreme cases, a Lockout is possible. Emitter and receiver wiring is low voltage; routing the sensor wires alongside power wires, motor/servo wires, or other high-voltage wiring may inject noise into the EZ-SCREEN System. It is good wiring practice (and may be required by code) to isolate emitter and receiver cables from high-voltage wires, avoid routing cables close to “noisy” wiring, and provide a good connection to earth ground.

Sensor QD cabling and any interconnect wiring should meet the following specifications. The wires used should have an insulation temperature rating of at least 90°C (194°F).

	Maximum Machine Interface cable length (ft) versus total current draw (including both OSSD loads)					
	0.5A	0.75A	1.0A	1.25A	1.5A	1.75A
18 AWG	375	250	188	148	125	109
20 AWG	240	160	120	95	80	70
22 AWG*	150	100	75	59	50	44

*QDE...D cables, see table 2.2

See Section 7.4 for cascade installations.

NOTE: Maximum cable lengths are intended to ensure that adequate power is available to the EZ-SCREEN System when the supply is operating at +24V dc – 15%.



WARNING . . . Proper Electrical Hookup

Electrical hookup must be made by Qualified Personnel and must comply with NEC (National Electrical Code) and local standards.

Make no more connections to the EZ-SCREEN System than are described in Sections 3.3.1 through 3.5.3 of this manual.

Connection of other wiring or equipment to the EZ-SCREEN System could result in serious bodily injury or death.

3.3 Initial Electrical Connections

Lockout/tagout procedures may be required (refer to OSHA 29CFR1910.147, ANSI Z244-1, or the appropriate standard for controlling hazardous energy). Following relevant electrical standards and wiring codes, such as the NEC, NFPA79 or IEC60204-1, always connect earth ground (green/yellow wire, see Figures 3-20 through 3-23). **Do not operate the EZ-SCREEN System without an earth ground connection. See the warning below.**

Make the electrical connections in the order described in this section. Do not remove end-caps; no internal connections are to be made. All connections are made through the M12 Euro-style quick-disconnects.

When installing QD cables, do not use tools to tighten the coupling nut (i.e. hand-tighten only). **Do not rotate the body of the QD, or damage to the connector can occur.**

Emitter Cable

Standard EZ-SCREEN emitters have an 8-pin cable, but only three conductors are used (Brown = +24V dc, Blue = 0V dc, Green/Yellow = GND). The other wires are in place to allow a parallel connection (color-for-color) to the receiver cable (see Figure 3-19), providing sensor interchangeability (or swapability); either sensor may be installed at either cordset connection. In addition to providing similar cabling, this wiring scheme is advantageous during installation, wiring, and troubleshooting.

Emitters with the optional TEST function (model number suffix Q5) use a 5-pin cable (see Figure 3-20). Locate the black and the white wires at the cable end; if the Test input will be used, temporarily connect the ends of the wires to each other (but not to an external contact at this time). **If the Test input will not be used, connect the emitter cable black and white wires together and properly terminate (e.g., with the included wire-nut).**

Receiver Cable

Do not connect any wires to the machine control circuits (i.e., OSSD outputs) at this time. For the initial power-up and checkout, NO EDM must be configured. Locate the orange and orange/black wires (pins 2 and 3) and temporarily connect the ends of the wires to each other (but not to the machine at this time). Take precautions to prevent the wires from shorting to ground or to other sources of energy (e.g., terminate with the included wire-nut). Final EDM wiring must be completed later.

If used, connect the external reset switch to the reset wire (violet) on the receiver cable and to 24V dc (see Figures 3-21 and 3-23). See warning in Section 3.1.3 about the physical location of the external reset switch. The reset switch must be a normally open switch that is held closed for approximately 1/4 second, but no longer than 2 seconds, and then re-opened to accomplish the reset. The switch must be capable of switching 10 to 30V dc at 30 mA.

3.4 Light Screen Initial Checkout

The initial checkout procedure must be performed by a Qualified Person (see Section 4.1). It must be performed only after configuring the System and after connecting the emitter and receiver per Section 3.3.

Configuring the System for Initial Checkout

Verify that Test input is jumpered (if used) and the System is set to the factory defaults for initial checkout and optical alignment. (Factory defaults are for Trip Output, 2-Channel EDM, Reduced Resolution OFF, and Scan Code 1. See Figure 4-1.)

The procedure is performed on two occasions:

- To ensure proper installation when the System is first installed, and
- To ensure proper System function whenever any maintenance or modification is performed on the System or on the machinery being guarded by the System. (See Section 6.1 for a schedule of required checkouts.)

For the initial checkout, the EZ-SCREEN System must be checked without power being available to the guarded machine. **Final interface connections to the guarded machine cannot take place until the light screen system has been checked out.** This may require lockout/tagout procedures (refer to OSHA1910.147, ANSI Z244-1, or the appropriate standard for controlling hazardous energy). These connections will be made after the initial checkout procedure has been successfully completed.

Verify that:

- Power has been removed from (or is not available to) the guarded machine, its controls or actuators; and
- The machine control circuit or the Interface Module is not connected to the OSSD outputs at this time (permanent connections will be made later); and
- EDM is configured for No Monitoring, per Section 3.3.2.

3.4.1 Initial Power-Up and Optical Alignment

1. **Inspect the area near the light screen for reflective surfaces**, including work pieces and the guarded machine. Reflective surfaces may cause light beams to reflect around a person in the light screen, preventing the person from being detected and not stopping the machine motion. See Section 3.1.6.

Eliminate the reflective surfaces as possible by relocating them, painting, masking or roughening them. Remaining problem reflections will become apparent during step 5.

2. **Verify that power is removed from the EZ-SCREEN System and from the guarded machine** and that the OSSD safety outputs are not connected. Remove all obstructions from the light screen.

Leaving power to the guarded machine OFF, make power and earth ground connections on both the emitter and receiver cables (see Figures 3-20 to 3-23) and then power up the EZ-SCREEN System (only).

Verify that input power is present to both emitter and receiver. At least one indicator on both emitter and receiver should be ON and the start-up sequence should cycle.

3. Observe both the emitter and the receiver System Status indicators and the receiver Zone indicators to determine light screen alignment status:
 - **A Lockout condition** (emitter or receiver) – the System Status indicator single-flashing Red, and the receiver Zone and Reset indicators OFF. Proceed to Section 5 for diagnostic information.
 - **Normal operating mode** (emitter) – the System Status indicator ON Green.
 - **TEST mode** (5-pin emitters only) – a flashing Green System Status indicator (Test input open, see Figure 3-20 and Section 5.2).
 - **A Latch condition** (receiver), all optical beams clear – the receiver System Status indicator ON Red and the Reset indicator double-flashing Yellow; Zone indicators ON Green. When the receiver is configured for Latch Output, the outputs are ON only when all beams are clear and after a manual reset (see Section 1.4.7). If a reset routine can cause a Clear (RUN) condition, optimize the alignment as described in step 4. If a Clear (RUN) condition can not be achieved, see “Blocked condition” below.
 - **A Clear (RUN) condition** (receiver) – the System Status indicator ON Green (or flashing Green if Reduced Resolution is enabled), and the Reset indicator ON Yellow. All Zone indicators ON Green.

To optimize alignment and maximize excess gain, slightly loosen the sensor mounting screws (x4) and rotate one sensor left and right, noting the positions where the Status indicators turn Red (Blocked condition); repeat with the other sensor (see Figure 3-11). Center each sensor between those two positions and tighten the end cap mounting screws, making sure to maintain the positioning as the screws are tightened. The sensor lenses should directly face each other. Proceed to System Configuration (Section 3.4.2) once optimum optical alignment is verified.

- **A Blocked condition** (receiver) is indicated by the System Status indicator ON Red, the yellow Reset indicator ON, and one or more Zone indicator(s) ON Red, identifying the location of the blocked beams, and the number of blocked beams will be displayed. Proceed to step #4.

NOTE: If beam 1 is blocked, Zone indicator 1 will be Red and all others will be OFF. Beam 1 provides the synchronization signal.

NOTE: If the Test input is open, the 3-digit Diagnostic Display will indicate the total number of beams in the system (minus one) and all Zone indicators will be Red.

4. Optical Alignment

CAUTION: Ensure that no individuals are exposed to any hazard if the EZ-SCREEN receiver turns ON the OSSD outputs when the System becomes aligned.

Verify sensor mounting per Section 3.2.

Verify Optimal Alignment (Rotational Adjustment with power ON)

- Ensure the emitter and receiver are pointed squarely at each other. A straight edge (e.g., a level) can determine the direction the sensor is facing (see Figure 3-11). The sensor face must be perpendicular to the optical axis.

NOTE: At power-up, all indicators are tested (flash), then the Scan Code is displayed.

- If Channel #1 beam is not aligned, the Status and Zone 1 indicators are Red and the Diagnostic Display indicates "CH1". Zone indicators 2-8 will be OFF.
- If the Green Status and Yellow Reset indicators are ON, go to step "d". If not, rotate each sensor (one at a time) left and right until the Green Status indicator comes ON. As the sensor rotates out of alignment, the Red Status indicator will come ON steady. As more beams are made, the Zone indicators will turn from Red to Green and the number of blocked beams displayed will decrease.

NOTE: If the Emitter's Test input is open, the 7-segment display will indicate the total number of beams (minus one) in the System and all Zone indicators will be Red (except for 10-beam systems, where the Zone 1 indicator will be Green).

- To optimize alignment, note the position where the Red Status indicator comes ON when the sensor is rotated both left and right. Center the sensor between the two positions, and tighten the end cap mounting screws, making sure the positioning does not drift as the screws are tightened. Repeat for second sensor.

For situations where alignment is difficult, a **LAT-1-SS Laser Alignment Tool** can be used to assist or confirm alignment by providing a visible red dot along the sensor's optical axis (see Figure 3-13).

- If, at any time, the Red Status indicator begins to flash steadily, the System has entered a Lockout condition. See Section 5.1.1 for further information.

Optical Alignment Procedure with Mirrors

EZ-SCREEN sensors may be used with one or more corner mirrors for guarding more than one side of an area. The MSM... and SSM... rear-surface glass mirrors are rated at 85% efficiency. Thus, **excess gain and sensing range are reduced when using mirrors; see Section 3.1.7.**

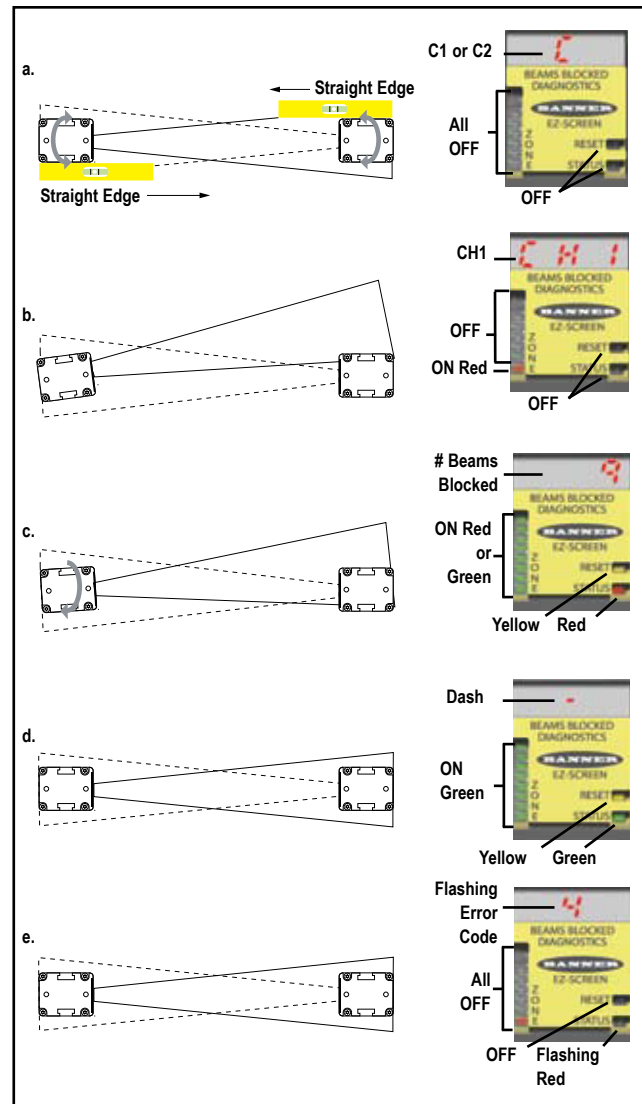

Figure 3-11. Optimum optical alignment

In addition to the standard optical alignment procedure, verify (see Figure 3-12):

- That the emitter, receiver, and all mirrors are level and plumb,
- The middle of the defined area and the center point of the mirrors are approximately the same distance from a common reference point, such as the same height above a level floor. Ensure that there are equal amounts of mirror surface above and below the defined area such that the optical beams are not passing below or above the mirror.

During any adjustments, allow only one individual to adjust any one item at any one time.

NOTE: A LAT-1-SS Laser Alignment Tool is very helpful by providing a visible red dot along the optical axis. See Figure 3-13 and Banner Safety Applications Note SA104 (P/N 57477) for further information.

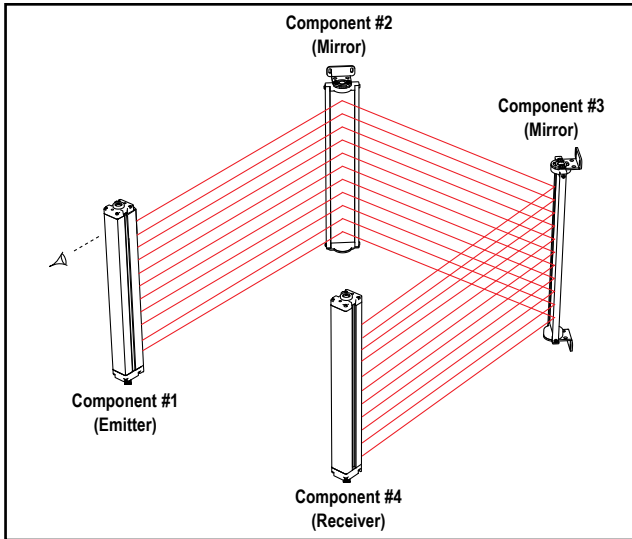

Figure 3-12. Corner mirror alignment

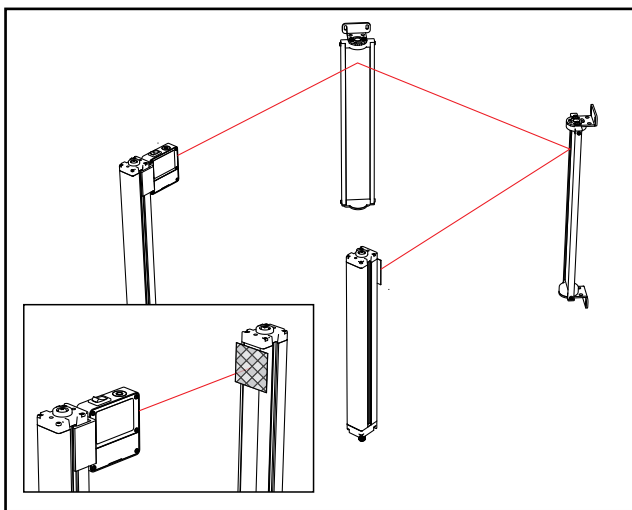

Figure 3-13. Optical alignment using the LAT-1

3.4.2 Reduced Resolution (Floating Blanking)

Reduced Resolution allows objects of a certain maximum size to interrupt the defined area without causing a Trip condition (i.e., the OSSDs turn OFF). **Use Reduced Resolution only when necessary.** In Reduced Resolution applications, the separation distance always increases due to the larger depth penetration factor (Dpf). In either case see Section 3.1.1 to determine separation distance.

With 2-beam Reduced Resolution enabled, **any two consecutive beams**, (except for the sync beam), can be blocked without causing a stop condition. Thus, multiple “holes” are created in which 14 mm systems will “see” a 30 mm object and ignore an 8.5 mm object. Similarly, 30 mm systems will “see” a 60 mm object and ignore a 17 mm object. See Figure 4-1 for DIP-switch configuration. During operation, the Status indicator flashes Green when Reduced Resolution is enabled.

Model	Reduced Resolution Setting	Maximum Size of Undetected Objects	Resulting Resolution
14 mm Resolution	OFF	(Not applicable)	14 mm (0.55")
	ON (2-beam)	8.5 mm (0.34")	30 mm (1.18")
30 mm Resolution	OFF	(Not applicable)	30 mm (1.18")
	ON (2-beam)	17 mm (0.67")	60 mm (2.36")

⚠ WARNING . . . Use of Reduced Resolution and Fixed Blanking

Use Reduced Resolution and Fixed Blanking only when necessary. Any holes created in the defined area either must be completely filled by the blanked object or the separation distance must be increased to account for the larger resolution (see Section 3.1.1).

3.4.3 Fixed Blanking

One or multiple areas within an EZ-SCREEN sensor pair may be blanked out. The minimum number of beams between two blanked areas is one. Any beam other than the sync beam may be blanked. All beams of a fixed blanked area must stay blocked at all times (after the fixed blanking configuration mode has been exited), in order for the OSSDs to stay ON.

Fixed Blanking Configuration Procedure

- From normal operation or a power OFF condition, move the second and third DIP switches (the first RR and T/L) both to the left (T and RR position). See Figure 3-14.
- Move the fourth and fifth DIP switches (the second RR and T/L) both to the right (L and OFF position).
- The receiver should now either be in a lockout condition or power is still OFF.
- If power is OFF:** Apply power
Lockout condition: Perform a valid reset sequence (close the reset switch for 0.25 to 2 seconds, then reopen the switch).
- Fixed Blanking configuration indicated by:**
 - Display alternates between “PFA” and the number of blocked beams (“0” if all beams are clear). (PFA = Program Fixed Blanking Active)
 - Zone indicators active
 - Yellow Reset indicator OFF
 - Status indicator ON Red
- Position object(s) to be blanked.
- When beams are blocked, the 7-segment display alternates between “PFA” and the number of blocked beams. The zone indicators remain active and denote the location of blocked beams.

8. To teach the blanked beams, simply re-configure DIP switches for normal operation (see Figure 4-1). Verify that only the objects to be blanked are interrupting the defined area. A lockout will occur if an object is moved or removed after teaching.
9. Receiver indicates:
 - Display: PFC ON solid (PFC = Program Fixed Blanking Complete)
 - Zone indicators flash approximate location of fixed blanked area programmed
 - Reset indicator single-flashing Yellow
 - Status indicator single-flashing Red
10. Perform a valid reset sequence (see Step 4) or cycle power.
11. To disable fixed blanking, follow this same procedure, but remove all objects not to be blanked at Step 6.

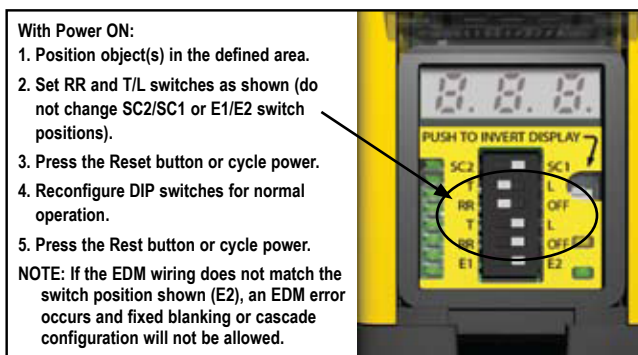

Figure 3-14. DIP switch configuration to teach fixed blanking

3.4.4 Trip Test

After optimizing the optical alignment and configuring fixed blanking and Reduced Resolution (if applicable), perform the trip test to verify the detection capability of the EZ-SCREEN System. This test will also verify correct sensor orientation (Section 3.1.5), identify optical short circuits (Section 3.1.6), and verify the expected resolution for applications using Reduced Resolution (Section 3.4.2). Once the installation has passed the trip test, the safety outputs may be connected and the commissioning checkout may be performed (initial installations only).

Appropriate Test Pieces for Trip Test		
Reduced Resolution	14 mm Resolution Models	30 mm Resolution Models
OFF	14 mm (0.55" dia. Model STP-13)	30 mm (1.18" dia. Model STP-14)
ON (2-beam)	30 mm (1.18" dia. Model STP-14)	60 mm (2.36" dia. Model STP-15)

Cascaded systems: To test a cascaded system, each light screen must be tested individually, while monitoring the status indicator on the first receiver in the cascade.

1. Select the proper test piece (see table above), supplied with the receiver.
2. Verify that the EZ-SCREEN is in RUN mode with the Green Status indicator ON (or flashing if Reduced Resolution is enabled), all Zone indicators are Green, and the Yellow Status indicator ON. A manual reset may be required in Latch mode (see Sections 4.2 and 4.3).
3. Pass the specified test piece through the defined area in three paths: near the emitter, near the receiver, and midway between the emitter and receiver (Figure 3-15).
4. During each pass, while the test piece is interrupting the defined area, at least one Zone indicator **must be Red. The Red Zone indicator must change with the position of the test piece within the defined area.**

• **Trip Output Operation:** The Status indicator must turn Red and remain Red for as long as the test piece remains in the defined area. If not, the installation has failed the trip test.

Latch Output Operation: The Status indicator must turn Red and remain Red. The Yellow Reset indicator must remain ON steady. If the Reset indicator begins to flash at any time while the test piece is interrupting the defined area, the installation has failed the trip test.

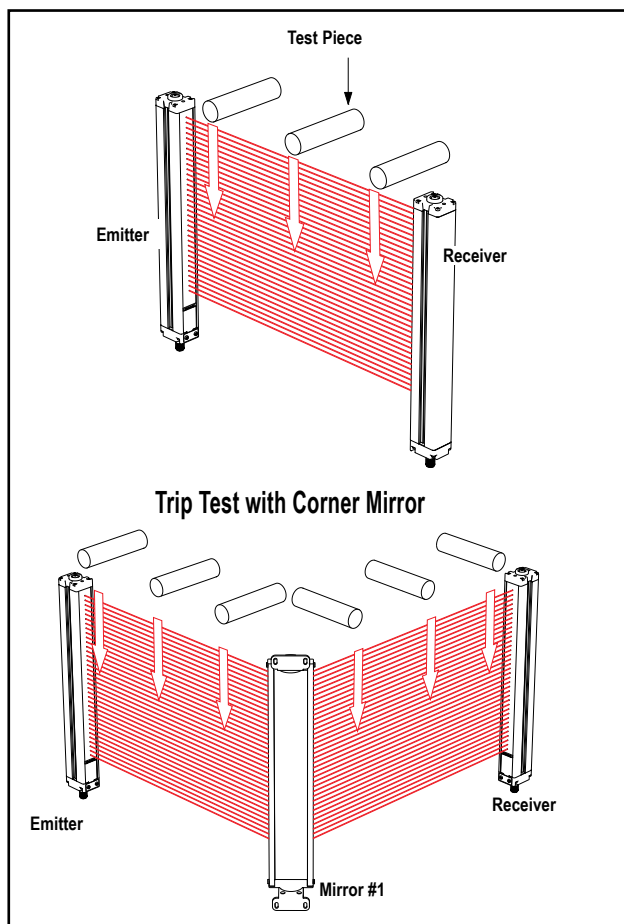

Figure 3-15. EZ-SCREEN trip test

⚠ WARNING . . . If Trip Test Indicates a Problem

If the EZ-SCREEN System does not respond properly to the trip test, do not attempt to use the System.

If this occurs, the EZ-SCREEN cannot be relied on to stop dangerous machine motion when a person or object enters the defined area.

Serious bodily injury or death could result.

If all Zone indicators turn Green or fail to follow the position of the test piece while it is within the defined area, the installation has failed the trip test. Check for correct sensor orientation, reflective surfaces and unguarded areas created due to the use of Blanking. Do not continue until the situation is corrected.

When the test piece is removed from the defined area, in Trip Output Operation, the Status indicator must turn ON Green (or flash Green, if Reduced Resolution is enabled). In Latch Output Operation, the Status indicator will remain Red until a manual reset is performed (the Yellow Reset indicator will be flashing).

If mirrors are used in the application: Test the defined area on each leg of the sensing path (e.g. emitter to mirror, between mirror and receiver, see Figure 3-15).

If the EZ-SCREEN System passes all three checks during the trip test, go on to Section 3.5.

3.5 Electrical Interface to the Guarded Machine

Permanent Hookup

Make the electrical connections as described in Sections 3.5.1 to 3.5.4 as required by each individual application.

Lockout/tagout procedures may be required (refer to OSHA 1910.147, ANSI Z244-1, or the appropriate standard for controlling hazardous energy). Follow relevant electrical standards and wiring codes, such as the NEC, NFPA79 or IEC 60204-1. See the warning in Section 3.3.

Supply power and the external reset switch should already be connected. The EZ-SCREEN must also have been aligned and passed the Initial Checkout, as described in Section 3.4.

The final connections to be made are:

- OSSD outputs
- FSD interfacing
- MPCE/EDM connections
- Optional remote Test

⚠ WARNING . . . Interfacing of Both OSSDs

Both of the OSSD (Output Signal Switching Device) outputs must be connected to the machine control so that the machine's safety-related control system interrupts the circuit to the machine primary control element(s), resulting in a non-hazardous condition.

Never wire an intermediate device(s) (e.g., PLC, PES, PC) that can fail in such a manner that there is the loss of the safety stop command, OR in such a manner that the safety function can be suspended, overridden, or defeated, unless accomplished with the same or greater degree of safety.

⚠ WARNING . . . OSSD Interfacing

To ensure proper operation, the EZ-SCREEN OSSD output parameters and machine input parameters must be considered when interfacing the EZ-SCREEN solid-state OSSD outputs to machine inputs.

Machine control circuitry must be designed so that the maximum load resistance value is not exceeded and that the maximum specified OSSD OFF-state voltage does not result in an ON condition.

Failure to properly interface the OSSD outputs to the guarded machine could result in serious bodily injury or death.

⚠ WARNING . . . Shock Hazard

Always disconnect all power from the EZ-SCREEN System and the guarded machine before making any connections or replacing any component. Use extreme caution to avoid electrical shock at all times.

3.5.1 OSSD Output Connections

Both the Output Signal Switching Device (OSSD) outputs must be connected to the machine control so that the machine's safety-related control system interrupts the circuit or power to the Machine Primary Control Element(s) (MPCE), resulting in a non-hazardous condition.

Final Switching Devices (FSDs) typically accomplish this when the OSSDs go to an OFF state. See Figure 3-21.

Refer to the output specifications in Section 2.7 and the warning at left before making OSSD output connections and interfacing the EZ-SCREEN System to the machine.

3.5.2 FSD Interfacing Connections

FSDs (Final Switching Devices) can take many forms, though the most common are forced-guided, mechanically linked relays or an interface module. The mechanical linkage between the contacts allows the device to be monitored by the External Device Monitoring circuit for certain failures.

Depending on the application, the use of FSDs can facilitate controlling voltage and current that differs from the OSSD outputs of the EZ-SCREEN. FSDs can also be used to control an additional number of hazards by creating multiple safety stop circuits.

Safety Stop Circuits

A safety stop allows for an orderly cessation of motion for safeguarding purposes, which results in a stop of motion and removal of power from the MPCEs (assuming this does not create additional hazards). A safety stop circuit typically comprises a minimum of two normally open (N.O.) contacts from forced-guided, mechanically linked relays, which are monitored (through External Device Monitoring) to detect certain failures in order to prevent the loss of the safety function. Such a circuit can be described as a "safe switching point." Typically, safety stop circuits are either single-channel, which is a series connection of at least two N.O. contacts; or dual-channel, which is a separate connection of two N.O. contacts. In either method, the safety function relies on the use of redundant contacts to control a single hazard (if one contact fails ON, the second contact will arrest the hazard and prevent the next cycle from occurring). See Figure 3-21.

The interfacing of the safety stop circuits must be accomplished so that the safety function can not be suspended, overridden, or defeated, unless accomplished in a manner at the same or greater degree of safety as the machine's safety related control system that includes the EZ-SCREEN.

The normally open safety outputs from an interface module provide a series connection of redundant contacts that form safety stop circuits for use in either single-channel or dual-channel control. (See Figure 3-23.)

Dual-Channel Control

Dual-channel control provides the ability to electrically extend the safe switching point beyond the FSD contacts. With proper monitoring (i.e., EDM), this method of interfacing is capable of detecting certain failures in the control wiring between the safety stop circuit and the MPCEs. These failures include a short-circuit of one channel to a secondary source of energy or voltage, or the loss of the switching ability of one of the FSD outputs. Such failures could lead to the loss of redundancy — or to a complete loss of safety, if not detected and corrected.

The possibility of a failure to the wiring increases as the physical distance between the FSD safety stop circuits and the MPCEs increase, as the length or the routing of the interconnecting wires increases, or if the FSD safety stop circuits and the MPCEs are located in different enclosures. For this reason, dual-channel control with EDM monitoring should be used in any installation where the FSDs are located remotely from the MPCEs.

Single-Channel Control

Single-channel control uses a series connection of FSD contacts to form a safe switching point. After this point in the machine's safety-related control system, failures can occur that would result in the loss of the safety function (such as a short-circuit to a secondary source of energy or voltage).

For this reason, single-channel control interfacing should be used only in installations where FSD safety stop circuits and the MPCEs are mounted within the same control panel, adjacent to each other, and are directly connected to each other; or where the possibility of such a failure can be excluded. If this can not be achieved, then dual-channel control should be used.

Methods to exclude the possibility of these failures include, but are not limited to:

- Physically separating interconnecting control wires from each other and from secondary sources of power.
- Routing interconnecting control wires in separate conduit, runs, or channels.
- Locating all elements (modules, switches, and devices under control) within one control panel, adjacent to each other, and directly connected with short wires.
- Properly installing multi-conductor cabling and multiple wires through strain relief fittings. (Over-tightening of a strain-relief can cause short-circuits at that point.)
- Using positive-opening or direct-drive components, installed and mounted in a positive mode.

3.5.3 Machine Primary Control Elements and EDM Inputs

A machine primary control element (MPCE) is an “electrically powered element that directly controls the normal operation of a machine in such a way that it is the last element (in time) to function when machine operation is to be initiated or arrested” (per IEC61496-1). Examples include motor contactors, clutch/brakes, valves, and solenoids.

Depending on the level of risk of harm, it may be required to provide redundant MPCEs or other control devices that are capable of immediately stopping the dangerous machine motion, irrespective of the state of the other. These two channels of machine control need not be identical (i.e., diverse redundant), but the stop time performance of the machine (Ts, used to calculate the separation distance, see Section 3.3.1) must take into account the slower of the two channels. Refer to Figure 3-23 or consult the machine manufacturer for additional information.

To ensure that an accumulation of failures does not compromise the redundant control scheme (i.e., cause a failure to danger) a method to verify the normal functioning of MPCEs or other control devices is required. EZ-SCREEN provides a convenient method for this verification: external device monitoring (EDM).

For the EZ-SCREEN external device monitoring to function properly, each device must include a normally closed (N.C.), forced-guided (mechanically linked) contact that can accurately reflect the status of the device. This ensures that the normally open contacts, used for controlling hazardous motion, have a positive relationship with the normally closed monitoring contacts and can detect a failure to danger (e.g., contacts that welded closed or stuck ON).

It is strongly recommended that a normally closed, forced-guided monitoring contact of each FSD and MPCE be connected to EDM inputs (see Figures 3-21 and 3-23). If this is done, proper operation will be verified. Monitoring FSD and MPCE contacts is one method of maintaining control reliability (OSHA/ANSI) and Category 3 and 4 (EN954-1/ISO13849-1).

If monitoring contacts are not available or do not meet the design requirement of being forced-guided (mechanically linked), it is recommended to:

- Replace the devices so that they capable of being monitored,
or
- Incorporate the EDM function into the circuit as close to the MPCE as possible (e.g., monitor the FSDs),
and
- Employ use of well-tried, tested, and robust components, and generally accepted safety principles, including fault exclusion, into the design and installation to either eliminate, or reduce to an acceptable (minimal) level of risk, the possibility of undetected faults or failures that can result in the loss of the safety function.

WARNING . . . EDM Monitoring

If system is configured for “no monitoring,” it is the user’s responsibility to ensure that this does not create a hazardous situation.

The principle of fault exclusion allows the designer to design out the possibility of various failures and justify it through the risk assessment process to meet the required level of safety performance, such as the requirements of Category 2, 3 or 4. See ISO 13849-1/-2 for further information.

External Device Monitoring

EZ-SCREEN provides three possible EDM configurations: 1-channel monitoring, 2-channel monitoring, and no monitoring. Their functions are described below. The most common form of EDM is 1-channel monitoring; its primary advantages are simplicity of wiring and the ability to use the Auxiliary output. The installation must prevent short circuits across the N.C. monitoring contacts and to secondary sources of power. Two-channel monitoring has the ability to detect additional failures, such as short circuits, and should be used when those failures can not be designed out or reasonably be excluded. Two-channel monitoring is also the default setting and has the advantage on additional diagnostic capability that can identify which specific element that has slowed or failed.

External Device Monitoring Hookup

If not connected previously, it is again strongly recommended that one normally closed, forced-guided monitoring contact of each FSD and MPCE be wired as shown in the monitoring circuit (see Figures 3-21 and 3-23). Pins 2 and 3 of the receiver connector provide connection for the external device monitoring input. External device monitoring (EDM) must be wired in one of three configurations described below and this wiring configuration must agree with the receiver’s EDM DIP switch settings (see Section 4.2).

One-Channel Monitoring: This is a series connection of closed monitor contacts that are forced-guided (mechanically linked) from each device controlled by the EZ-SCREEN. The monitor contacts must be closed before the EZ-SCREEN can be reset and the OSSDs can turn ON. After a reset is executed and the safety outputs (OSSDs) turn ON, the status of the monitor contacts are no longer monitored and may change state. However, the monitor contacts must be closed within 250 milliseconds of the OSSD outputs going from ON to OFF. See Figure 3-16.

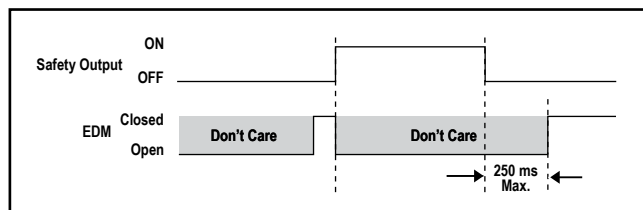

Figure 3-16. One-channel EDM status, with respect to safety output

Refer to Figure 3-23 for 1-channel EDM hookup. Connect the monitor contacts between +24V dc and EDM1 (pin 3). Leave EDM2 (pin 2) open (no connection). Set the configuration DIP switch to E1, per Section 4.2.

NOTE: For EZ-SCREEN receivers with a date code prior to 0834, the monitoring contacts must open within 200 milliseconds of the OSSD outputs turning ON (a clear condition) and must close within 200 milliseconds of the OSSD outputs turning OFF (a blocked condition) or a lockout will occur.

Two-Channel Monitoring: This is an independent connection of closed monitor contacts that are forced-guided (mechanically linked) from each device controlled by the EZ-SCREEN. The monitor contacts must be closed before the EZ-SCREEN can be reset and the OSSDs can turn ON. Regardless of the state of the OSSDs, the monitor contacts may change state (either both open, or both closed). If the monitor contacts remain in opposite states for more than 250 milliseconds, a lockout will occur.

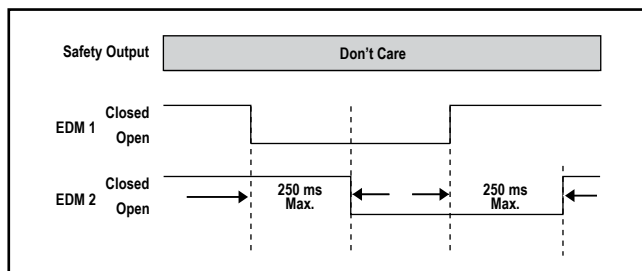

Figure 3-17. Two-channel EDM, timing between channels

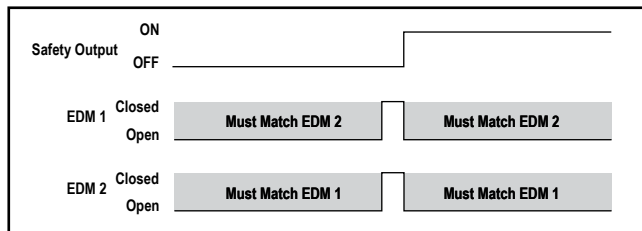

Figure 3-18. Two-channel EDM status, with respect to safety output

Refer to Figures 3-21 or 3-23 for 2-channel EDM hookup. Connect the monitor contacts as shown between +24V dc and EDM1 (pin 3) and between +24V dc and EDM2 (pin 2). Set the configuration DIP switch to E2, per Section 4.2.

NOTE: For EZ-SCREEN receivers with a date code prior to 0834, the monitoring contacts must always close within 200 milliseconds of the corresponding OSSD state change (turning OFF) or a lockout will occur.

No Monitoring: Use this configuration initially, in order to perform the initial checkout; see Section 3.6. *If the application does not require the EDM function, it is the user's responsibility to ensure that this configuration does not create a hazardous situation.*

Refer to Figure 3-22 for “no monitoring” hookup. To configure the EZ-SCREEN for no monitoring, connect or jumper EDM1 (pin 3) to EDM2 (pin 2) using the supplied wire-nut. Set the configuration DIP switch to E2, per Section 4.2.

An alternate method to configure no monitoring is to set the configuration DIP switch to E1 (1-channel monitoring), per Section 4.2, and connect EDM1 (pin 3) to +24V dc. This method allows the ability to use the auxiliary output (see Section 3.5.5) in applications that do not require the EDM function.

3.5.4 Optional Remote Test Input

A pair of connections is provided on 5-pin emitters (Test1 and Test2) for the connection of an external remote test switch (typically a normally open contact held closed). Opening this switch “turns OFF” the emitter, simulating an interruption of the light beams; all OSSD outputs will turn OFF. See Sections 2.7.2, 3.3.1, and Figure 3-20.

3.5.5 Auxiliary (Aux) Output

On EZ-SCREEN receivers with date code 0834 or newer, an auxiliary status output is available that provides a PNP current-sourcing output (75 mA max.) that mirrors the state of the OSSDs. The output is on pin 2 (orange/black wire) when the EDM configuration DIP switch is set to E1 (1-channel monitoring), per Section 4.2. See the 1-channel EDM circuit on Figure 3-23 for hookup information.

To use the auxiliary output in an application configured for no monitoring, set the configuration DIP switch to E1 (1-channel monitoring) per Section 4.2., and connect EDM1 (pin 3) to +24V dc (see Section 3.5.3).

There are no compatibility issues retrofitting receivers with aux output into earlier installations, if precautions are taken to prevent EDM2 (pin 2, orange/black wire) from shorting to ground or another source of energy.

3.6 Preparing for System Operation

After the initial trip test has been accomplished, the OSSD safety outputs and EDM connections have been made to the machine to be controlled, the EZ-SCREEN is ready for testing in combination with the guarded machine.

The operation of the EZ-SCREEN with the guarded machine must be verified before the combined EZ-SCREEN and machine may be put into service. To do this, **a Qualified Person must perform the Commissioning Checkout Procedure described in Section 6.2.**

3.7 Sensor “Swapability” and the Optional Emitter Hookup

Figure 3-16 illustrates an optional hookup that provides sensor interchangeability (or “swapability”) – the ability to install either sensor at either QD connection. To hook up an 8-pin QD emitter, use only three conductors (Brown = +24V dc, Blue = 0V dc, Green/Yellow = GND). Connect the remaining wires in a parallel connection (color-for-color) to the receiver cable.

The resulting installation provides the ability to swap the emitter and receiver position, similar to a popular feature of Banner MACHINE-GUARD™, MINI-SCREEN® and MICRO-SCREEN® safety light screens. This hookup option provides advantages during installation, wiring, and troubleshooting.

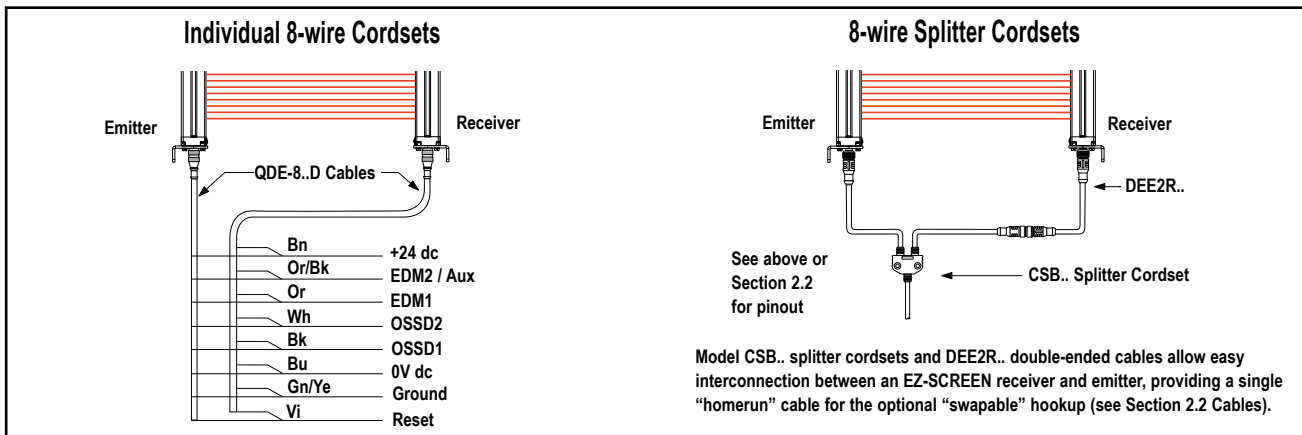

Figure 3-19. Emitters and receivers interchange easily when 8-pin connectors are used for both (optional hookup)

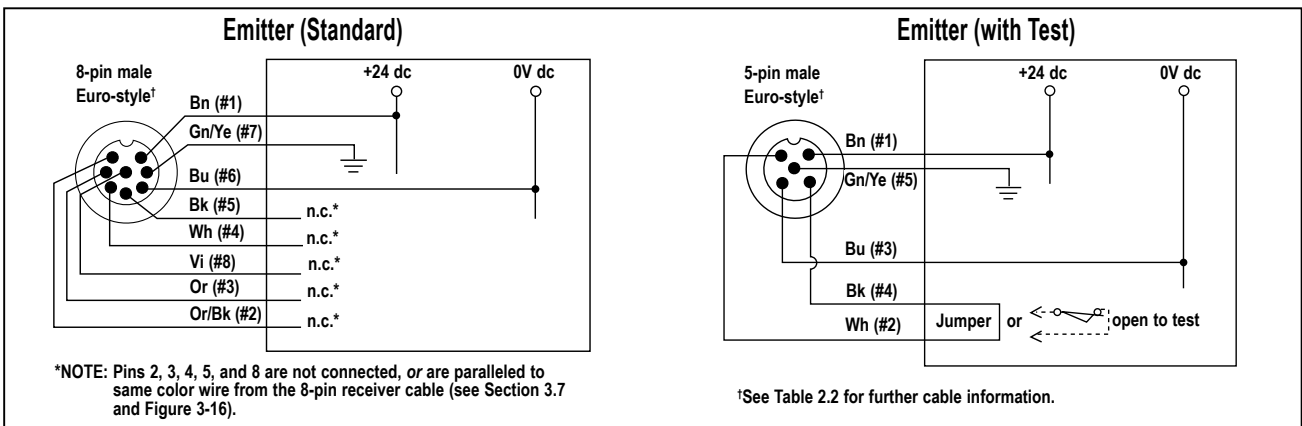

Figure 3-20. Emitter; generic hookup

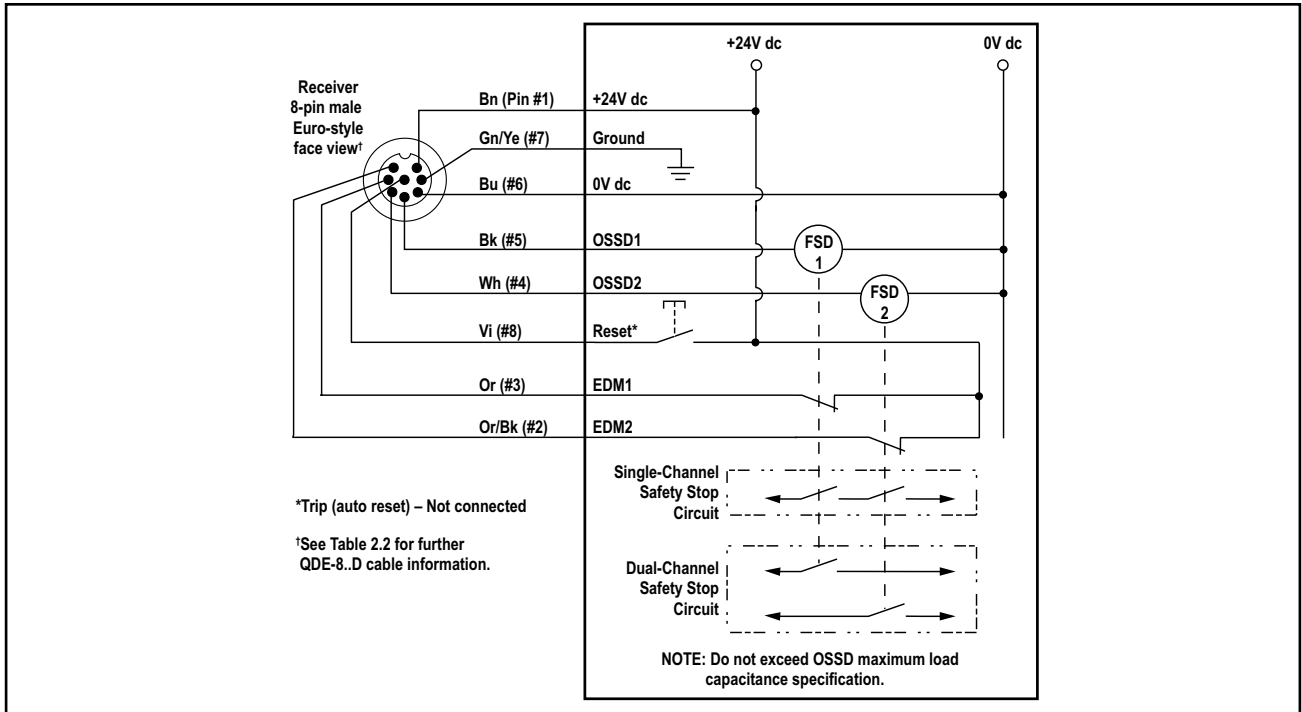

Figure 3-21. Generic hookup – FSDs (2-channel EDM, manual reset)

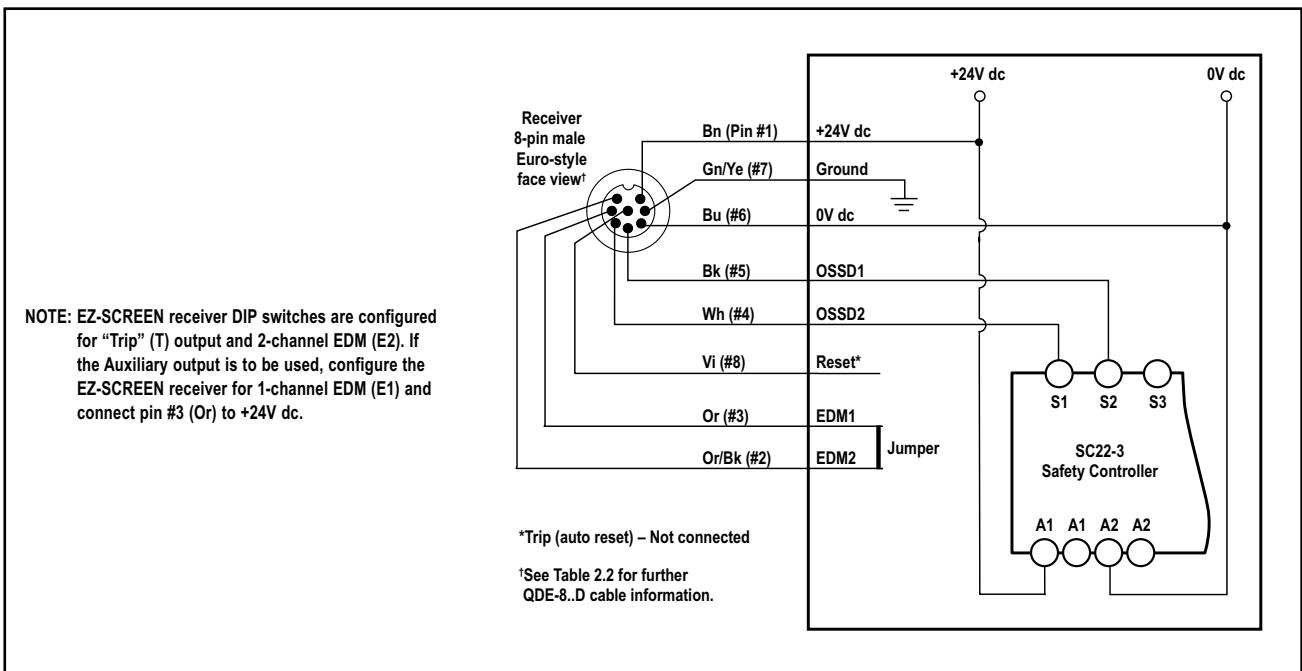
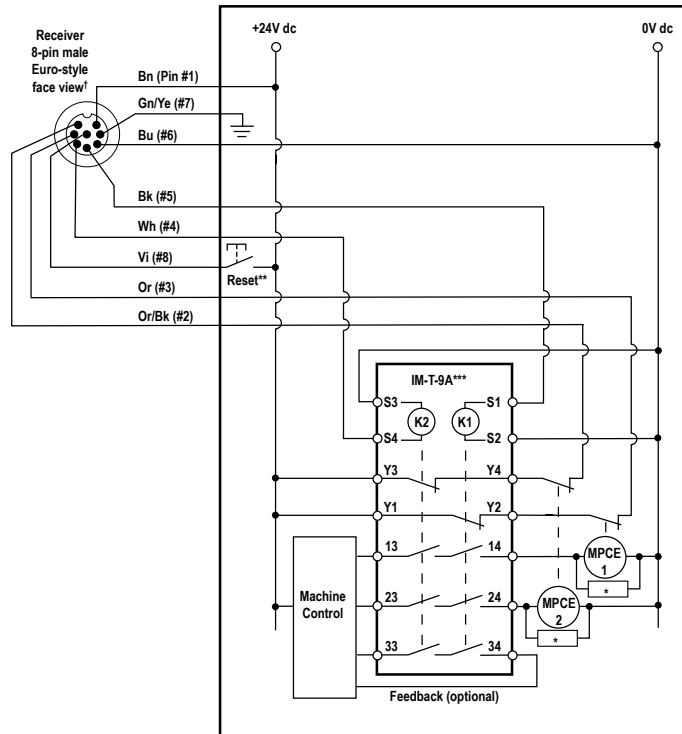

Figure 3-22. Generic hookup – self-checking Safety Module, Safety Controller, Safety PLC (no monitoring, automatic reset)

⚠ WARNING . . . Use of Transient Suppressors

If transient suppressors are used, they **MUST** be installed across the coils of the machine control elements. **NEVER** install suppressors directly across the contacts of the IM-T-..A Module. It is possible for suppressors to fail as a short circuit. If installed directly across the contacts of the IM-T-..A Module, a short-circuit suppressor will create an unsafe condition.

2-Channel EDM



1-Channel EDM

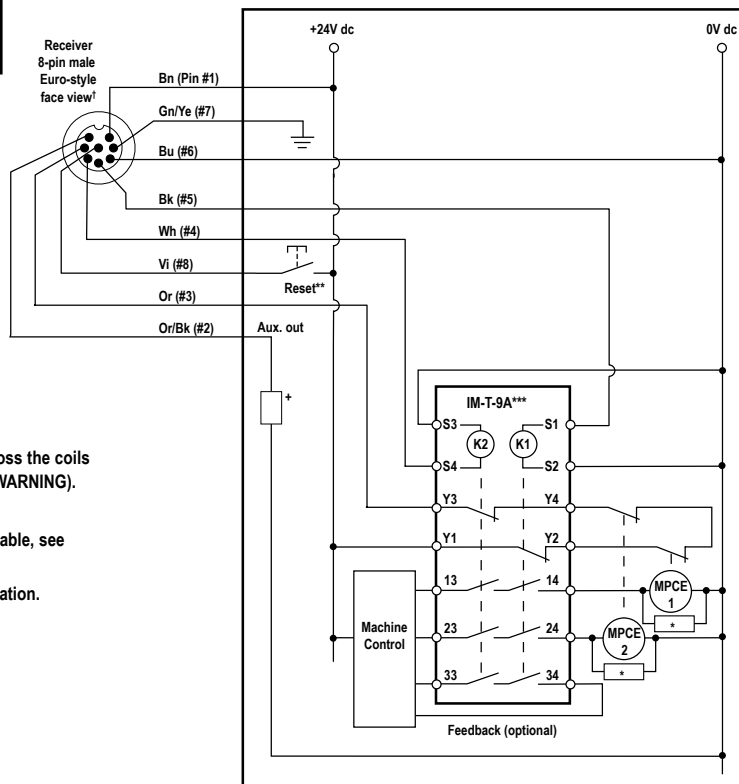

- * Installation of transient (arc) suppressors across the coils of MPCE1 and MPCE2 is recommended (see WARNING).
- ** Trip (auto reset) — Not connected
- *** Other interfacing modules and solutions available, see Section 2.3 or the Banner Safety Catalog.
- † See Table 2.2 for further QDE-8D cable information.

Figure 3-23. Generic hookup – Interface Module (1-Channel or 2-Channel EDM, manual reset)

4. System Operation

4.1 Security Protocol

Certain procedures for installing, maintaining and operating the EZ-SCREEN system must be performed by either Designated Persons or Qualified Persons.

A **Designated Person** is identified and designated in writing, by the employer, as being appropriately trained and qualified to perform system resets and the specified checkout procedures on the EZ-SCREEN System. The Designated Person is empowered to:

- Perform manual resets and hold possession of the reset key (see Section 4.3), and
- Perform the Daily Checkout Procedure (see Section 6).

A **Qualified Person**, by possession of a recognized degree or certificate of professional training, or by extensive knowledge, training and experience, has successfully demonstrated the ability to solve problems relating to the installation of the EZ-SCREEN System and its integration with the guarded machine. In addition to everything for which the Designated Person is empowered, the Qualified Person is empowered to:

- Install the EZ-SCREEN System,
- Perform all checkout procedures (see Section 6),
- Make changes to the internal configuration settings, and
- Reset the System following a Lockout condition.

4.2 System Configuration Settings

If not previously configured, System settings are made on the configuration panels located on each sensor, behind the access cover. The access cover is opened by first removing the factory-installed security plate with the security hex wrench provided. It is recommended that the security plate be re-installed after any configuration changes. See Figure 4-1.

Because it has redundant microprocessors, the receiver has two DIP switch banks (bank A and bank B) which must be set identically (see Section 4.2). Failure to do so will cause a Lockout condition when power is applied. **Power to the EZ-SCREEN receiver should be OFF when changing DIP switch settings or a Lockout will occur.**

After configuration settings are verified/set, the access cover must be fully closed (snap shut) to maintain IP ratings. **Other than Scan Code, all configuration settings should be changed only when the System is OFF.**

NOTE: The corresponding pairs of DIP switches must be set identically for the System to operate.

Scan Code is used to allow operation of multiple pairs of emitters and receivers in close proximity (see Sections 3.1.8 and 1.4.4). Scan Code may be set to 1 or 2, using the switch on the configuration panel. The Scan Code setting for each emitter must agree with its corresponding receiver. The Scan Code settings may be changed while in RUN mode without causing a Lockout.

Trip or Latch Output operation is selected on two DIP switches in the receiver configuration port; see Figure 4-1. Both switches must be set to the same setting. If they have different settings, an error code will be displayed.

If the switches are set for Trip Output (T), the System will auto-reset. If the switches are set for Latch Output (L), the System will require a manual reset.

External Device Monitoring (EDM)/Aux. Output: EDM mode is selected via a 2-position DIP switch in the receiver configuration port; see Figure 4-1. For 1-Channel Monitoring, set the EDM DIP switch to the E1 position. For 2-Channel Monitoring or No Monitoring, set the switch to the E2 position. See Section 3.5.3 for more information. When 1-Channel Monitoring is selected, an aux. output is available; see Section 1.4.3.

Reduced Resolution: Two-beam Reduced Resolution can be enabled by selecting "RR" on both DIP switches as labeled.

NOTE: Enabling Reduced Resolution will affect the Minimum Separation Distance, see Section 3.1.1.

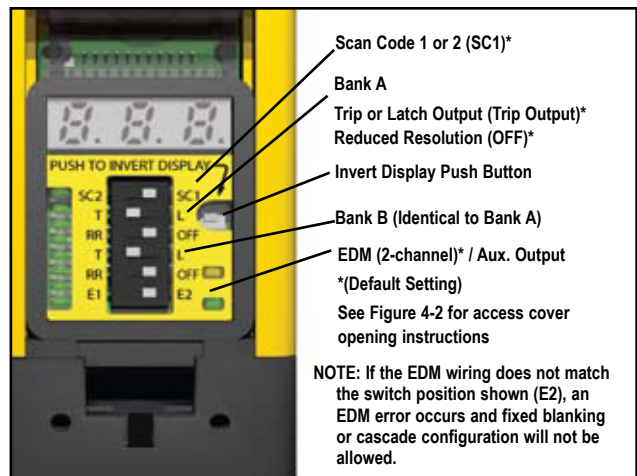

Figure 4-1. EZ-SCREEN configuration switches (receiver shown)

Accessing the Configuration Panel

To open the access cover for DIP switch configuration:

1. Remove the security plate using the special tool supplied.
2. Using a small flat blade screwdriver or the security plate tool, push the plastic tab on the access cover inwards at a 45° angle.
3. Pivot the screwdriver against the bevel until the access cover pops open.
4. To close the access cover, simply push cover into place (it will “snap” into place). The access cover has been designed to be removable, so if it should come off, simply snap it back onto the hinge and close it.
5. If required, replace the security plate with tamper-resistant screws provided, using the same supplied tool.

It is important to snap-close the cover to maintain the sensors' IP 65 environmental rating. In the event an access cover is lost or damaged, it can be re-ordered (see Section 2.5, Replacement Parts). It is recommended for installations subject to shock and vibration, that the security plate be reinstalled.

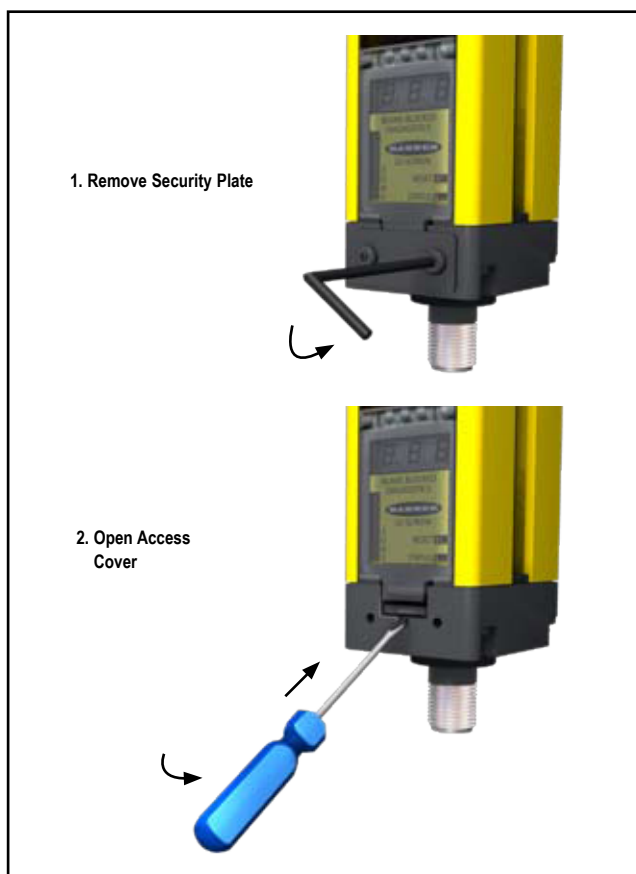

Figure 4-2. Accessing the configuration switches

4.3 Reset Procedures

Resetting the System

System resets are performed using an external reset switch. This switch must be located outside the guarded area, and must not be within reach from within the guarded area (see Section 3.1.3). Its location should provide a clear view of the entire safeguarded area. If any hazardous areas are not in view from the switch location, additional means of safeguarding must be provided. The switch should be protected from accidental or unintended actuation (e.g., through the use of rings or guards).

If supervisory control of the reset switch is required, a key switch may be used, with the key kept in the possession of a Designated or Qualified Person. Using a key switch will also provide some level of personal control, since the key may be removed from the switch. This will hinder a reset while the key is under the control of an individual, but must not be relied upon solely to guard against accidental or unauthorized reset. Spare keys in the possession of others or additional personnel entering the safeguarded area unnoticed may create a hazardous situation.

Receiver Resets

The EZ-SCREEN receiver has a Reset input, pin 8 (Violet wire), that allows the System to be manually reset.

The EZ-SCREEN requires a manual reset to clear a Latch condition and resume operation following a stop command. Internal Lockout conditions also require a manual reset to return the System to RUN mode after the failure has been corrected and the input correctly cycled.

Receiver manual resets are required in the following situations:

- **Trip Output operation** – only after a System Lockout (see Section 5 for causes).
- **Latch Output operation** – at power-up, after each Latch condition occurs, and after a System Lockout.

Reset Routine

To reset the receiver, close the reset switch for 1/4 to 2 seconds, then open the switch. (If reset switch model MGA-KS0-1, listed in Section 2, is used, turn the key 1/4 turn clockwise to close; turn counterclockwise, back to its original position, to open.)

NOTE: Closing the reset switch too long will cause the System to ignore the reset request; the switch must be closed from 1/4 second to 2 seconds, but no longer.

Emitter Resets

In the rare occurrence that an emitter requires a reset, power the sensor down, then power it up. Emitter resets are needed only if a Lockout occurs.

4.4 Status Indicators

A variety of status indicators are clearly visible on each emitter and receiver front panel (see Figure 1-3 and Section 3.4.1, steps #3 and #4), and Section 7.7 (cascadeable models only).

Emitter: A single bi-color Red/Green Status indicator shows whether power is applied, and whether the emitter is in RUN mode, optional TEST mode, or Lockout status. A 7-segment Diagnostic Display indicates a specific error code when the emitter is in Lockout; the display also momentarily indicates the Scan Code setting at power-up or when changed.

Receiver: Bi-color Red/Green Zone indicators show whether a section of the defined area is aligned and clear, or is blocked and/or misaligned. A Yellow Reset indicator shows when the System is in RUN mode or is waiting for a reset. There are 8 Zone indicators for all model lengths, each of which indicates Blocked/Clear conditions for approximately 1/8 of the total light screen.

A bi-color Red/Green Status indicator shows when the OSSD outputs are ON (Green) or OFF (Red), or the System is in Lockout status (flashing Red). A 3-digit 7-segment Diagnostic

Display indicates the receiver's Trip (-) or Latch (L) configuration setting and displays a specific error code when the receiver is in Lockout. The 7-segment display also momentarily indicates the Scan Code setting at power-up or when changed.

















Operating Status	Required Event	Status Indicator	Diagnostic Display	
Power-up	Apply power	Red single-flash	Scan code flash 3x – alternates  then  or  then 	
Run Mode	Passes internal tests	Green	Dash	
Test Mode	Open Test switch	Flashing Green	Dash	
Lockout	Internal/external fault	Flashing Red	Displays error code (see Section 5.1)	

Figure 4-3. Emitter status indicator operation

Operating Mode	Required Event	Reset Indicator	Status Indicator	Zone Indicators*	Diagnostic Displays			OSSD Outputs
Power-up	Apply power	OFF	Single-Flash Red	All Single-Flash Red	Scan code flash 3x – alternates  then  or  then 			OFF
Alignment Mode – Beam 1 Blocked	Pass internal tests	OFF	OFF	Zone 1 Red* Others OFF				OFF
Alignment Mode – Beam 1 Clear	Align Beam 1	ON	Red	Zone 1 Green Others Red or Green	Total number of blocked beams			OFF
Run Mode – Clear	Align all beams	ON	ON or Flashing Green†	All ON Green	OFF		OFF	ON
Run Mode – Blocked	Beam(s) blocked	ON	Red	Red or Green*	Total number of blocked beams			OFF
Noise Detected – Reset Interface					Flashing 	Continues previous reading	Continues previous reading	
Noise Detected – EDM Interface					Continues previous reading	Continues previous reading	Flashing 	
Lockout	Internal/external fault	OFF	Flashing Red	All OFF	Displays error code (see Section 5.1)			OFF

* NOTE: If beam 1 is blocked, Zone indicators 2-8 will be OFF, because beam 1 provides the synchronization signal for all the beams.

† Flashing if Reduced Resolution is enabled.

Figure 4-4. Receiver status indicator operation (Trip Output configured)

Operating Mode	Required Event	Reset Indicator	Status Indicator	Zone Indicators*	Diagnostic Displays			OSSD Outputs
Power-up	Apply power	OFF	Single-Flash Red	All Single-Flash Red		Scan code flash 3x – alternates then or then		OFF
Alignment Mode – Beam 1 Blocked	Pass internal tests	OFF	OFF	Zone 1 Red*, Others OFF				OFF
Alignment Mode – Beam 1 Clear	Align Beam 1	ON	Red	Beam 1 Green, others Red or Green	Total number of blocked beams			OFF
Alignment Mode – All Beams Clear	Align all beams	Double-Flash	Red	All ON Green	OFF		OFF	OFF
Run Mode – Clear	Perform reset	ON	ON or Flashing Green†	All ON Green	OFF		OFF	ON
Latched – Blocked Beam 1 Blocked	Block Beam 1	ON	Red	Red or Green*				OFF
Latched – Blocked Beam 1 Clear	Block 1 or more beams	ON	Red	Red or Green*	Total number of blocked beams			OFF
Latched – Clear	Clear all beams	Flashing	Red	All ON Green	OFF		OFF	OFF
Noise Detected – Reset Interface					Flashing	Continues previous reading	Continues previous reading	
Noise Detected – EDM Interface					Continues previous reading	Continues previous reading	Flashing	
Lockout	Internal/external fault	OFF	Flashing Red	OFF	Displays error code (see Section 5.1)			OFF

* NOTE: If beam 1 is blocked, Zone indicators 2-8 will be OFF, because beam 1 provides the synchronization signal for all the beams.

† Flashing if Reduced Resolution is enabled.

Figure 4-5. Receiver status indicator operation (Latch Output configured)

Inverted Display

For applications that require the emitter and receiver to be inverted (with the status indicator ends at the “top”), the 7-segment displays on EZ-SCREEN emitters and receivers can be inverted for easy reading. Press the Invert Display push button, located next to the DIP switches, under the access cover (Figure 4-6). A single momentary push is required; if pressed too long (longer than 1/2 second), the display will not invert.

A spare access cover with inverted label and an inverted label for the display are provided in the hardware packets for each emitter and receiver (or see Section 2.5 Replacement Parts). Remove the standard access cover by removing the screw-on security plate and gently pulling the cover out. Place the inverted label over the existing label on the display (adjacent to the DIP

switches) and snap the inverted-label access cover into place; replace screw-on security plate if desired.



Figure 4-6. Inverted display showing the number 10 and the inverted label

Status Indicators for Cascaded Applications

When multiple light screens are cascaded, some unique indications may occur, as indicated in Figure 4-7 and in the table at right.

When a receiver's CSSI input is in a Stop condition (because of a blocked light screen further upstream in the cascade, or because of a Stop signal from an E-stop button, for example), the display on the downstream receivers, including the master receiver, will be bracketed by a pair of vertical "goalposts." See Section 5.1.1 for an illustration.

EZ-SCREEN Cascade Diagnostics

Condition	OSSDs	Display	Reset Indicator	Status Indicator
Receiver #1 (Master)				
Clear	ON	L	ON	Green
CSSI Stop (Receiver #2, 3, or 4 is blocked)	OFF	---	ON	Red
Latch	OFF	L	Flashing	Red
Receiver #2, 3, or 4				
Clear	ON	-	ON	Green
Blocked	OFF	# Beams blocked	ON	Red
CSSI Stop (Receiver upstream is blocked)	OFF	---	ON	Red
Cleared	ON	-	ON	Green

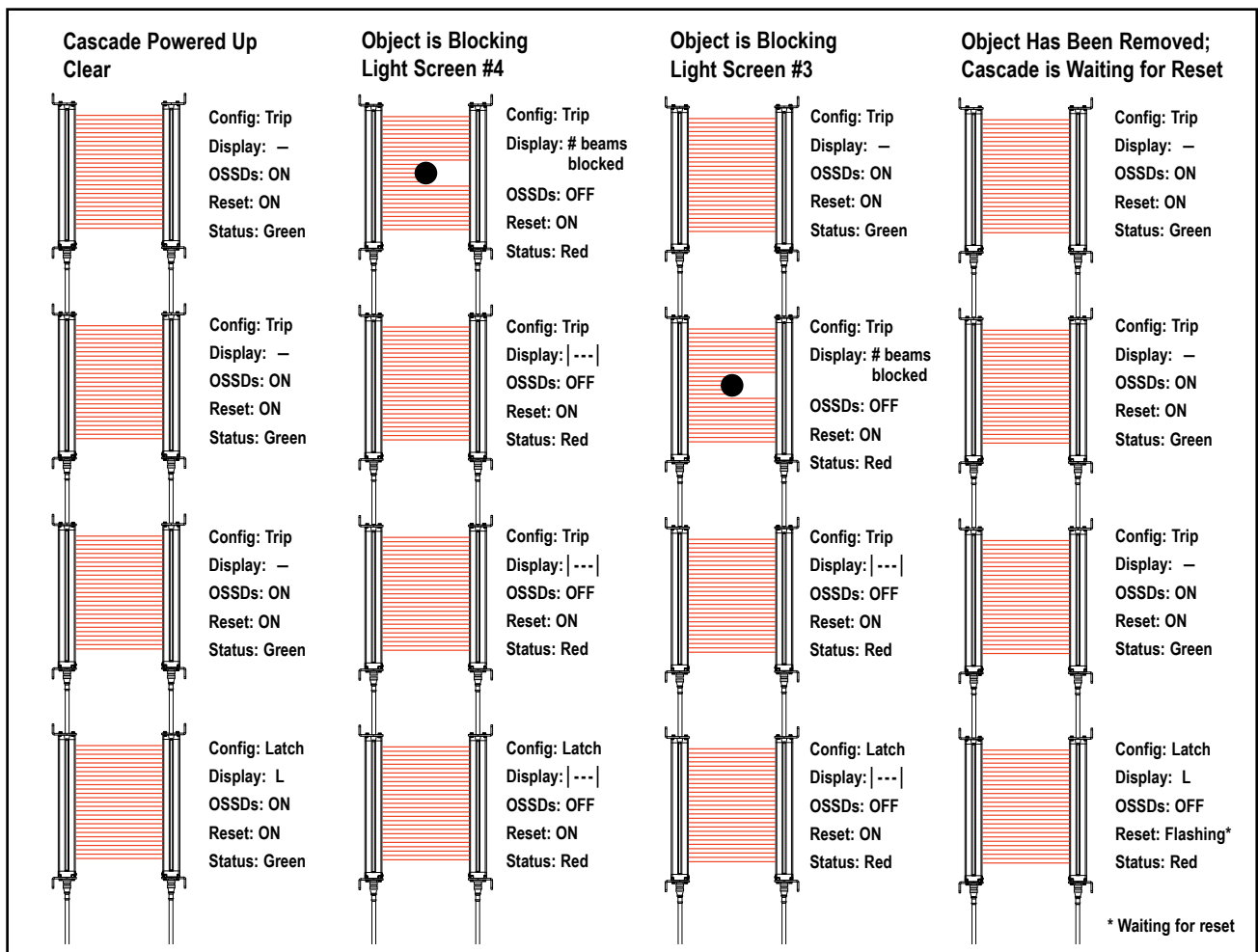

Figure 4-7. Cascade indicator status conditions

4.5 Normal Operation

System Power-Up

The EZ-SCREEN will power up in one of two ways, depending on the Trip/Latch Output configuration. If it is set for Trip Output, it will power up and reset automatically; if it is set for Latch Output, it will require a manual reset procedure after power-up and sensor alignment.

Trip Output Power-Up: When power is applied, each sensor will conduct self-tests to detect critical internal faults, determine configuration settings, and prepare the EZ-SCREEN for operation. (If either sensor detects a critical fault, scanning ceases, the receiver outputs remain OFF and diagnostic information is displayed through the sensor's front window.) If no faults are detected, the EZ-SCREEN will automatically enter ALIGNMENT mode, with the receiver looking for an optical sync pattern from the emitter. If the receiver is aligned and receiving the proper sync pattern, it enters RUN mode and begins scanning to determine the blocked or clear status of each beam. No manual reset operation is required.

Latch Output Power-Up: When power is applied, each sensor will conduct self-tests to detect critical internal faults, determine configuration settings, and prepare the System for operation. (If either sensor detects a critical fault, scanning ceases, the receiver outputs remain OFF and diagnostic information is displayed through the sensor's front window.) If no faults are detected, the EZ-SCREEN will automatically enter ALIGNMENT mode, with the receiver looking for an optical sync pattern from the emitter. If the receiver is aligned and receiving the proper sync pattern, it begins scanning to determine the blocked or clear status of each beam. When all beams are aligned, the Yellow Reset indicator will double-flash to indicate the EZ-SCREEN is waiting for a manual reset. After a valid manual reset, the EZ-SCREEN enters RUN mode and continues scanning.

During RUN Mode

Trip Output Configuration: If any beams become blocked while the EZ-SCREEN is running with Trip Output selected, the receiver outputs turn OFF within the stated EZ-SCREEN response time (see Specifications). If all the beams then become clear, the receiver outputs come back ON. No resets of any kind are needed. All required machine control resets are provided by the machine control circuit.

Latch Output Configuration: If any beams become blocked while the EZ-SCREEN is running with Latch Output selected, the receiver outputs turn OFF within the stated EZ-SCREEN response time (see Specifications). If all the beams then become clear, the receiver Zone indicators will all be Green and the Reset indicator will single-flash, indicating the EZ-SCREEN is waiting for a manual latch reset. In Latch Output operation, the outputs come back ON only when all beams are clear and after a manual reset. The EZ-SCREEN will wait for a manual reset; when a valid reset signal is received and all beams remain clear, the receiver outputs turn ON.

Internal Faults (Lockouts): If either sensor detects a critical fault, scanning ceases, the receiver outputs turn OFF and diagnostic information is displayed through the sensor's front window. See Section 5 for resolution of error/fault conditions.

4.6 Periodic Checkout Requirements

To ensure continued reliable operation, the System must be checked out periodically.

At every shift change, power-up and machine setup change, the Daily checkout should be performed; this checkout may be performed by a Designated or Qualified Person (see Section 6.3 and the Daily Checkout Card for the procedure).

Semi-annually, the EZ-SCREEN and its interface to the guarded machine should be thoroughly checked out; this checkout must be performed by a Qualified Person (see Section 6.4). A copy of these test results should be posted on or near the machine.

Whenever changes are made to the System (either a new configuration of the EZ-SCREEN or changes to the machine), the Commissioning Checkout should be performed (see Section 6.2).



WARNING . . . Verify Proper Operation

It is the user's responsibility to verify proper operation, on a regular basis, as instructed in Section 6. **Failure to correct such problems can result in serious bodily injury or death.**

5. Troubleshooting and Maintenance

5.1 Troubleshooting Lockout Conditions

Evaluate status indicators per Section 4.4. See Section 5.2 for Test mode indication.

A Lockout condition causes all of the EZ-SCREEN OSSD outputs to turn or remain OFF, sending a stop signal to the guarded machine. Each sensor provides diagnostic error codes to assist in the identification of the cause(s) of lockouts (see Sections 5.1.1 and 5.1.2 or the Diagnostic Error Code label supplied in the documentation pack).

The System provides easy methods for determining operating problems. A Lockout condition is indicated by the following:

Emitter	
Status indicator	Flashing Red
Diagnostic Display	Error code (flashing)
Receiver	
Reset indicator	OFF
Status indicator	Flashing Red
Zone Indicators	OFF
Diagnostic Display	Error code (flashing)

Recovery Procedures

To recover from a Lockout condition, all errors must be corrected and a single sensor reset sequence must be performed as described below.

Receiver Reset

Close the receiver Reset switch for 1/4 to 2 seconds and then open the switch (per Section 4.3), or power the sensor down, wait a second or two, then power it up.

NOTE: If the power down/up method is used and the EZ-SCREEN is set for Latch Output, a manual reset, as described in Section 4.3, is required to resume full operation.

Emitter Reset

Power the sensor down, wait a second or two, and then power it up.

WARNING . . . Lockouts and Power Failures

Power failures and Lockout conditions are indication of a problem and must be investigated immediately by a Qualified Person. **Attempts to continue to operate machinery by bypassing the EZ-SCREEN or other safeguards is dangerous and could result in serious bodily injury or death.**

WARNING . . . Shut Down Machinery Before Servicing







The machinery to which the EZ-SCREEN is connected **must not be operating at any time during major service or maintenance**. This may require lockout/tagout procedures (refer to OSHA1910.147, ANSI Z244-1, or the appropriate standard for controlling hazardous energy). **Servicing the EZ-SCREEN while the hazardous machinery is operational could result in serious bodily injury or death.**

Advanced Diagnostics









In addition to the standard error codes (see Sections 5.1.1 and 5.1.2), the EZ-SCREEN has the ability to display advanced diagnostic codes for the purpose of factory troubleshooting and repair functions. These codes are generally not intended for field troubleshooting by the EZ-SCREEN user.

These advanced codes have three digits (alternating "Axx"/"Bxx", where "xx" are two alpha-numeric characters); they are displayed by holding the Reset input high (+24V dc) or holding the Invert Display button down for five seconds during a lockout condition. If the advanced diagnostic codes are inadvertently displayed, simply hold the Invert Display button down for 5 seconds to return to the standard error code display.

5.1.1 Receiver Error Codes

Diagnostic Display	Error Description	Cause of Error and Appropriate Action
	<p>Output Error Error is caused by:</p> <ul style="list-style-type: none"> • one or both outputs being shorted to a power supply (high or low), • by shorting OSSD 1 to OSSD 2, or • by an overload (greater than 0.5A). 	<ul style="list-style-type: none"> • Disconnect the OSSD loads and reset the receiver. • If the error clears, the problem is in the OSSD load(s) or in the load wiring. • If the error continues with no load connected, replace the receiver.
	<p>Reset Input Error This error occurs when the Reset switch is closed (or the wiring is shorted to +24V) during power-up.</p>	<ul style="list-style-type: none"> • Verify that the reset switch is in the open position. • Reset the receiver per Section 4.3. • If the error remains, disconnect the reset wire at pin 8; cycle power. • If the error clears, the problem is in the reset switch or in the wiring. • If the error continues when the reset wire is disconnected, replace the receiver.
	<p>EDM Input Error Can occur for the following reasons:</p> <ul style="list-style-type: none"> • EDM wiring configuration does not match the EDM switch configuration. • No connection to EDM connections. • Both EDM inputs fail to respond within 250 ms of each other. • Excessive noise on EDM inputs. • Loose QD connection(s). 	<ul style="list-style-type: none"> • Verify that the EDM configuration switches are set correctly and that the wiring is correct for the EDM type configured (see Section 3.5.3). • Reset the receiver. • If the error continues, remove power to the guarded machine, disconnect the OSSD loads, disconnect the EDM input signals, configure EDM for No Monitoring (Section 3.5.3) and conduct the Initial Checkout procedure in Section 3.4. • If the error clears, the problem is in the external device contacts or wiring, or is a response-time problem of the external devices. Verify that the EDM wiring is correct and that the external devices meet the requirements described in Section 3.5.3. • If the error continues, check for noise on the EDM inputs (see Section 5.3). If error continues, replace the receiver
	<p>Receiver Error This error can occur due to either excessive electrical noise or an internal failure.</p>	<ul style="list-style-type: none"> • Perform a reset per Section 4.3. • If the error clears, perform a Daily Checkout procedure (per Section 6.3; Daily Checkout Card) and if OK, resume operation. If the System fails the Daily Checkout procedure, replace the receiver. • If the error continues, check the ground connection (pin 7). • If the sensor has a good earth ground connection to pin 7, perform the Initial Checkout procedure (per Section 3.4). • If the error clears, check the external connections and configuration settings. • If the error continues, replace the receiver.
	<p>DIP Switch Error This error can be caused by incorrect DIP switch settings or by changes to the DIP switch settings when the system is ON.</p>	<ul style="list-style-type: none"> • Verify that the DIP switch settings are valid (per Section 4.2). Make any corrections necessary and perform a receiver reset. • If the error occurred due to a change of the DIP switch settings while the System was in Run mode, verify the switch settings and perform a receiver reset to resume operation with the new switch settings and modified System configuration. • If the error continues, replace the receiver.
	<p>EDM 1 Error This error can occur due to EDM 1 input signal failing to respond within 250 ms of the OSSDs changing state (ON to OFF).</p>	<ul style="list-style-type: none"> • Verify that the EDM wiring is correct and that the external devices meet the requirements described in Section 3.5.3. • If the error continues, remove power to the guarded machine, disconnect the OSSD loads, disconnect the EDM input signals, configure EDM for No Monitoring (per Section 3.5.3) and conduct the Initial Checkout procedure in Section 3.4. • If the error clears, the problem is in the External Device contacts or wiring, or is a response-time problem of the external devices. Verify that the EDM wiring is correct and that the external devices meet the requirements described in Section 3.5.3. • If the error continues, check for noise on the EDM inputs (see Section 5.3).

5.1.1 Receiver Error Codes (continued)

Diagnostic Display	Error Description	Cause of Error and Appropriate Action
	EDM 2 Error EDM 2 configuration not valid (wiring or switch).	<ul style="list-style-type: none"> Verify that the EDM wiring is correct and that the external devices meet the requirements described in Section 3.5.3. If the error continues, remove power to the guarded machine, disconnect the OSSD loads, disconnect the EDM input signals, configure EDM for No Monitoring (per Section 3.5.3) and conduct the Initial Checkout procedure (Section 3.4). If the error clears, the problem is in the External Device contacts or wiring, or is a response-time problem of the external devices. Verify that the EDM wiring is correct and that the external devices meet the requirements described in Section 3.5.3. If the error continues, check for noise on the EDM inputs (see Section 5.3).
	Fixed Blanking Error This error occurs when beam(s) that have been blanked (programmed to ignore a fixed object) become clear when the object is removed or moved.	<ul style="list-style-type: none"> Reposition the object and perform a key reset (or cycle power). Re-program (teach) the fixed blanked object(s), see Section 3.4.3.
	Programming Timeout Error This error occurs when the Fixed Blanking programming mode (teach) exceeds the ten-minute limit.	<ul style="list-style-type: none"> Re-program (teach) the fixed blanked object(s), see Section 3.4.3.
	Cascade Configuration Error This error occurs when the configuration sequence is incorrectly followed, receiver(s) 2, 3 or 4 are configured, or receiver 1 is moved to a different position in the cascade.	<ul style="list-style-type: none"> The CSSI Input channel(s) are shorted together or to another source of power or ground. Configure ONLY the first receiver in the cascade (connected to the machine interface). All other receivers must be set for 2-Ch. EDM (E2) and Trip Output (T), see Section 7.7. Re-configure the first receiver to adapt system to changes or replacement of other receivers, see Section 7.7. <p>NOTE: In a cascaded system, all receivers are connected together, and all emitters are connected together.</p>
	Excessive Noise Error – Reset Interface This error can occur due to excessive levels of electrical noise.	<ul style="list-style-type: none"> Perform a reset per Section 4.3. If the error clears, perform a Daily Checkout procedure (per Section 6.3; Daily Checkout Card) and if OK, resume operation. If the System fails the Daily Checkout procedure, replace the receiver. If the error continues, check the ground connection (pin 7). If the sensor has a good earth ground connection to pin 7, perform the Initial Checkout procedure (Section 3.4). If the error clears, check for sources of electrical noise (see Section 5.3). If the error continues, replace the receiver.
	Excessive Noise Error – EDM Interface This error can occur due to excessive levels of electrical noise.	
	Excessive Noise Error – Cascade Input This error can occur due to excessive levels of electrical noise.	
Flashing 	Cascade Input Simultaneity Operation of channels A and B mismatch > 3 seconds.	

5.1.2 Emitter Error Codes

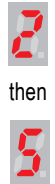
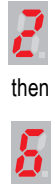
Diagnostic Display*	Error Description	Cause of Error and Appropriate Action
	Emitter Error This error can occur either due to excessive electrical noise or due to an internal failure.	<ul style="list-style-type: none"> Reset the emitter by cycling power to the emitter (see Section 4.3.2). If the error clears, perform a Daily Checkout procedure (Section 6.3) and if OK, resume operation. If the System fails the Daily Checkout procedure, replace the emitter. If the error continues, check the ground connection (see Section 2.3). If the sensor has a good earth ground connection, check for electrical noise (see Section 5.3). If the error continues, replace the emitter.
	Excessive Noise Error This error can occur due to excessive electrical noise.	<ul style="list-style-type: none"> Reset the emitter by cycling power to the emitter (see Section 4.3.2). If the error clears, perform a Daily Checkout procedure (Section 6.3) and if OK, resume operation. If the System fails the Daily Checkout procedure, replace the emitter. If the error continues, check the ground connection (see Section 2.3). If the sensor has a good earth ground connection, check for electrical noise (see Section 5.3). If the error continues, replace the emitter.

*Emitter has only 1-digit display. Two-digit codes are displayed sequentially.

5.2 Test Mode (5-Pin Emitters only)

If System can not be aligned or it will not go to a Green/Clear condition, the emitter's TEST input may be open.

When this occurs, the receiver Reset indicator is Yellow, all Zone indicators will be Red or Green, and the system Status LED will be Red; the 3-digit display will show a numerical value equal to one less than the total number of beams. For example, if an array has 50 beams total, the display would show 49. The emitter's Status indicator will flash Green. See Section 4.4 and Figure 5-1. (However, on a 10-beam system only, the Zone 1 indicator will be Green, and all others Red.)

Opening a switch or relay contacts connected to the TEST1 and TEST2 connections of the emitter, or supplying a voltage of less than 3V dc to TEST1 only, simulates a Blocked condition, for testing purposes.

To verify proper operation, measure the voltage between TEST1 (pin 4, black) and dc COM (pin 3, blue) of the emitter:

- If the voltage is 10 to 30V dc, the emitter should be in Run mode and beam scanning should be occurring. If not, check the +24V dc (pin 1, brown) to verify proper supply voltage. If the supply voltage is not within the rated supply voltage specifications, correct the supply voltage and recheck emitter operation. If the supply voltage is correct, Test1 is 10 to 30V dc and the emitter does not operate properly (RUN mode with beam scanning). Replace emitter.
- If the voltage is less than 3V dc, the emitter should be in Test mode and no scanning should be occurring. If not in Test mode, replace emitter.

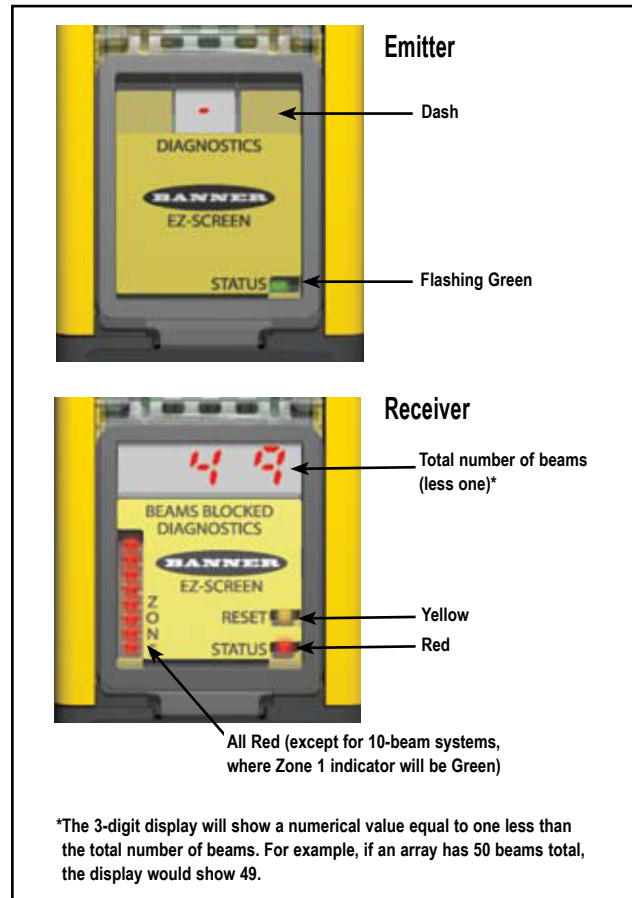

Figure 5-1. TEST mode status indicators

5.3 Electrical and Optical Noise

The EZ-SCREEN is designed and manufactured to be highly resistant to electrical and optical noise and to operate reliably in industrial settings. However, serious electrical and/or optical noise may cause a random Trip or Latch condition. In very extreme electrical noise cases, a Lockout is possible. In order to minimize the effects of transitory noise, the EZ-SCREEN will respond to noise only if the noise is detected on multiple consecutive scans.

If random nuisance Trips occur, check the following:

- Poor connection between the sensor and earth ground;
- Optical interference from adjacent light screens or other photoelectrics; or
- Sensor input or output wires routed too close to “noisy” wiring.

Checking for sources of electrical noise: It is very important that the light screen sensors have a good earth ground. Without this, the System can act like an antenna and random Trips and Lockouts can occur.

All EZ-SCREEN wiring is low voltage; running these wires alongside power wires, motor/servo wires, or other high-voltage wiring, can inject noise into the EZ-SCREEN system. It is good wiring practice (and may be required by code) to isolate EZ-SCREEN wires from high-voltage wires.

The Banner model BT-1 Beam Tracker (see Section 2.4) is a very good tool for detecting electrical noise. It can be used to detect electrical transient spikes and surges. Cover the lens of the BT-1 with electrical tape to block optical light from getting into the receiver lens. Press the “RCV” button on the BT-1 and position the Beam Tracker on the wires going to the EZ-SCREEN or any other nearby wires. Noise caused by the switching of inductive loads should be addressed by installing proper transient suppression across the load.

Checking for sources of optical noise: Turn off the emitter, completely block the emitter, or open the Test input, then use a Banner BT-1 Beam Tracker to check for light at the receiver. Press the “RCV” button on the BT-1 and move it across the full length of the receiver’s sensing window. If the BT-1’s indicator lights, check for light from other sources (other safety light screens, screens or points, or standard photoelectric sensors) by “tracking down” the emitted light from them.

5.4 Servicing and Maintenance

Cleaning

EZ-SCREEN emitters and receivers are constructed of aluminum with a yellow painted finish and are rated IP65. Lens covers are acrylic. Emitters and receivers are best cleaned using mild detergent or window cleaner and a soft cloth. **Avoid cleaners containing alcohol**, as they may damage the acrylic lens covers.

Warranty Service

EZ-SCREEN components are designed for reliability. Do not open the emitter or receiver housings, other than to access for configuration. They contain no field-replaceable components. If repair is necessary, do not attempt to repair an emitter or receiver yourself; return the unit to the factory.

Should it become necessary to return an EZ-SCREEN component to the factory, please do the following:

1. Contact the Banner Factory Application Engineering group at the address or numbers listed below:

**Banner Engineering Corp.,
Application Engineering Group
9714 Tenth Avenue North
Minneapolis, MN 55441**

**Phone: 763.544.3164 or
Toll-Free (US only): 888.373.6767
email: sensors@bannerengineering.com**

They will attempt to troubleshoot the system from your description of the problem. If they conclude that a component is defective, they will issue an RMA (Return Merchandise Authorization) number for your paperwork, and give you the proper shipping address.

2. Pack the component(s) carefully. Damage which occurs during return shipping is not covered by warranty.

6. Checkout Procedures

Study each procedure in its entirety, to understand each step thoroughly before beginning. Refer all questions to the Banner applications engineering department at the address or numbers listed on the cover of this manual. Checkouts must be performed as detailed in Section 6.1 below and results should be recorded and kept in the appropriate place (e.g., near the machine, and/or in a technical file).

6.1 Schedule of Checkouts

Trip Test: The procedure for EZ-SCREEN trip test is described in Section 3.4.4. This procedure must be performed at installation, and at any time the EZ-SCREEN, the guarded machine, or any part of the application is installed or altered. The procedure must be performed by a Qualified Person.

Commissioning Checkout: The procedure described in Section 6.2 must be performed at installation or whenever changes are made to the System (either a new configuration of the EZ-SCREEN or changes to the machine). The procedure must be performed by a Qualified Person.

Shift/Daily Checkout: The procedure for “daily” checkout of the EZ-SCREEN is described on the supplied Daily Checkout card (Banner p/n 113361 for SLS.. models, P/N 118173 for SLSC.. models). Daily Checkout is to be performed at each shift change or machine setup change, whenever the System is powered up — at least daily. The procedure is listed on the Daily Checkout card and may be performed by a Designated Person or a Qualified Person.

Semi-Annual Checkout: The procedure for initial checkout of the EZ-SCREEN System is to be performed every six months, following installation. The procedure is listed on the Semi-Annual Checkout card (Banner P/N 113362) and must be performed by a Qualified Person.

6.2 Commissioning Checkout

Perform this checkout procedure as part of the EZ-SCREEN installation (after it has been interfaced to the guarded machine as described in Section 3.5), or whenever changes are made to the System (either a new configuration of the EZ-SCREEN or changes to the machine). A Qualified Person (as defined in Section 4.1) must perform the procedure; checkout results should be recorded and kept on or near the guarded machine as required by applicable standards.

To prepare the System for this checkout:

1. Examine the guarded machine to verify that it is of a type and design compatible with the EZ-SCREEN. See Section 1.2 for a list of misapplications.
2. Verify that the EZ-SCREEN is configured for the intended application (see Section 4.2).
3. Verify that the minimum separation distance from the closest danger point of the guarded machine to the defined area is not less than the calculated distance, per Section 3.1.1 of this manual.
4. Verify that:
 - Access to any dangerous parts of the guarded machine is not possible from any direction not protected by the EZ-SCREEN, hard guarding, or supplemental safeguarding, and
 - It is not possible for a person to stand between the defined area and the dangerous parts of the machine, or
 - Supplemental safeguarding and hard guarding, as described by the appropriate safety standards, are in place and functioning properly in any space (between the defined area and any hazard) which is large enough to allow a person to stand undetected by the EZ-SCREEN (see Sections 3.1.2 and 3.1.4).
5. Verify that all reset switches are mounted outside and in full view of the guarded area, out of reach of anyone inside the guarded area, and that means of preventing inadvertent use is in place (see Section 3.1.3).
6. Examine the electrical wiring connections between the EZ-SCREEN FSD outputs and the guarded machine's control elements to verify that the wiring meets the requirements stated in Section 3.5.
7. Inspect the area near the defined area (including work pieces and the guarded machine) for reflective surfaces (see Section 3.1.6). Remove the reflective surfaces if possible by relocating them, painting, masking or roughening them. Remaining problem reflections will become apparent during the Trip Test in step 11.
8. Apply power to the EZ-SCREEN System. Verify that power to the guarded machine is OFF. Remove all obstructions from the defined area. If the EZ-SCREEN is configured for Manual Power-Up, the Yellow Status indicator will be double-flashing. Perform a manual reset (close the reset switch for 1/4 to 2 seconds, then open the switch).

9. Observe the Status indicators and the Diagnostic Display:

Lockout: Status flashing Red
All others OFF

Blocked: Status ON Red
One or more Zone indicators ON Red
Reset ON Yellow

Clear: Status ON Green*
All Zone indicators ON Green
Reset ON Yellow

Latch: Status ON Red
(defined All Zone indicators ON Green
area clear) Reset flashing Yellow

* The Green Status indicator will be flashing if Reduced Resolution is enabled.

10. A Blocked condition indicates that one or more of the beams is misaligned or interrupted. To correct this situation see the Alignment procedure in Section 3.4. If the system is in a Latch condition, perform a manual reset.

11. Once the Green and Yellow Status indicators are ON, **perform the trip test** (described in Section 3.4.4) on each sensing field to verify proper System operation and to detect possible optical short circuits or reflection problems. **Do not continue until the EZ-SCREEN System passes the trip test. Do not expose any individual to any hazard during the following checks.**

 **WARNING . . . Before Applying Power to the Machine**

Verify that the guarded area is clear of personnel and unwanted materials (such as tools) before applying power to the guarded machine. Failure to do so could result in serious bodily injury or death.

12. Apply power to the guarded machine and verify that the machine does not start up. Interrupt (block) the defined area with the appropriate supplied test piece (see table in Section 3.4.4) and verify that it is not possible for the guarded machine to be put into motion while the beam(s) is blocked.

13. Initiate machine motion of the guarded machine and, while it is moving, use the supplied test piece to block the defined area. **Do not attempt to insert the test piece into the dangerous parts of the machine.** Upon blocking any beam, the dangerous parts of the machine should come to a stop with no apparent delay.

Remove the test piece from the beam; **verify that the machine does not automatically restart**, and that the initiation devices must be engaged to restart the machine.

14. Remove electrical power to the EZ-SCREEN. Both OSSD outputs should immediately turn OFF, and the machine should not be capable of starting until power is re-applied to the EZ-SCREEN.

15. Test the machine stopping response time, using an instrument designed for that purpose, to verify that it is the same or less than the overall system response time specified by the machine manufacturer. (Banner's applications engineering department can recommend a suitable instrument.)

Do not continue operation until the entire checkout procedure is complete and all problems are corrected.

 **WARNING . . . Do Not Use Machine Until System Is Working Properly**

If any of these checks cannot be verified, do not attempt to use the EZ-SCREEN/guarded machine until the defect or problem has been corrected (see Section 5).

Attempts to use the guarded machine under such conditions could result in serious bodily injury or death.

6.3 Shift/Daily Checkout

Perform the procedure contained on the Daily Checkout card at every shift change, power-up and machine set-up change. During continuous machine run periods, this checkout should be performed at intervals not to exceed 24 hours.

A Designated Person or Qualified Person (as defined in the Safety Glossary) must perform the procedure. A copy of checkout results should be recorded and kept in the appropriate place (e.g., near or on the machine, in the machine's technical file).

Refer to the procedure detailed on the Daily Checkout card (Banner part number 113361 for SLS.. models, P/N 118173 for SLSC.. models) in the lit packet included with the receiver. If the Daily Checkout card is missing, contact Banner Engineering or download at www.bannerengineering.com.

6.4 Semi-Annual (Six-Month) Checkout

Perform the procedure contained on the Semi-Annual Checkout card every six months following System installation, or whenever changes are made to the System (either a new configuration of the EZ-SCREEN or changes to the machine).

A Qualified Person (as defined in the Safety Glossary) must perform the procedure. A copy of checkout results should be recorded and kept in the appropriate place (e.g., near or on the machine, in the machine's technical file).

Refer to the procedure contained on the Semi-Annual Checkout card (Banner part number 113362) in the lit packet included with the receiver. If the Semi-Annual Checkout card is missing, contact Banner Engineering or download at www.bannerengineering.com.

7. Cascadeable EZ-SCREEN†

7.1 Overview of Cascading

EZ-SCREEN emitters and receivers are also available in cascadeable models. These models can be used as stand-alone light screens, or can be cascaded up to four systems; see Figure 7-1. The cascaded sensor pairs can be any length, any number of beams, or have different resolutions (i.e., 14 mm and 30 mm), as long as each emitter matches its own receiver.

NOTE: EZ-SCREEN SLS models (with Inverted Display) can be used as the end sensor pair. EZ-SCREEN Grid/Point systems and PICO-GUARD systems can not be interfaced with the Cascade Input.

The control reliability, installation and alignment, electrical interface to the guarded machine, initial checkout, periodic checkout, troubleshooting and maintenance features of cascadeable models are functionally identical to those of the standard models.

Electrical connections are made through M12 (or Euro-style) quick-disconnects. The emitter has an 8-pin connector for power and ground. Optional 5-pin emitters with Remote Test function are available; see note at right.

The receiver has an 8-pin connector for power, ground, reset, EDM #1 and #2, and OSSD #1 and #2. All systems in a cascade are activating the same set of OSSD outputs, which are the OSSDs of the master receiver.

NOTE: In a cascaded system, all receivers are connected together, and all emitters are connected together.

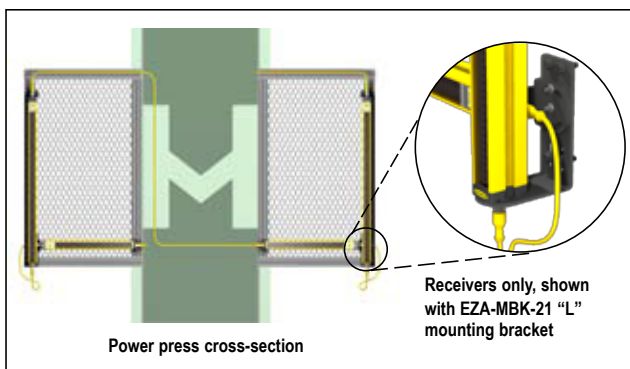

Figure 7-1. Multiple cascaded light screens used to guard two areas of one machine

† U.S. Patent(s) issued or pending

7.1.1 System Components and Specifications

A stand-alone cascadeable EZ-SCREEN system includes a compatible emitter and receiver (equal length and resolution; available separately or in pairs), a terminator plug for the receiver and two single-ended (machine interface) cables.

A multiple-light screen cascaded EZ-SCREEN system includes compatible emitter/receiver pairs (up to four), a terminator plug for the last receiver in the cascade, two single-ended cables to interface with the machine and provide power to the system, and pairs of double-ended (sensor interface) cables to interconnect the emitters and the receivers in the cascade.

The terminator plug must be used on the receiver in a stand-alone system, and on the last receiver in a multiple-system cascade or, a **QDE2R4-8..D** cable interfaced with an E-stop or other hard contacts (see Sections 7.8 and 7.9).

Available single-ended, double-ended, and splitter cables are listed in Section 2.3. Cable lengths are limited – for both the power cables and the interconnect cables; see Section 7.4 for more information.

Important Note about Remote Test in Cascaded Emitters

If a cascaded system requires the Remote Test function (see Section 1.4.4), then *all emitters in the cascade* must be 5-pin emitter models (model **SLSCE...Q5**); the interconnection between these cascaded emitters can only be accomplished using 5-pin **DEE2R-5..D** cables.

7.1.2 Receiver Display

In Run mode, the 7-segment display will show:

Clear condition

Latch Output operation " L "

Trip Output operation " - "

Blocked condition

Number of blocked beams

CSSI Input OFF or open (e.g., "upstream" receiver is blocked or in lockout)

"|---|" Solid (not flashing)

See Section 5.1.1 if any indication is flashing.

7.2 Cascadeable Emitter and Receiver Models – 14 mm Resolution

For cabling options, see Section 2.3.

Machine interface/power cables (one per end sensor, two per pair): Use QDE-..D cables.

Sensor interconnect cables (one per cascaded sensor, two per pair): Use DEE2R-..D cables.

Defined Area Height*	14 mm Resolution Cascadeable Models† 0.1 m to 6 m (4" to 20') range				
	Emitter (8-pin)	Receiver	Emitter/Receiver Pair	Number of Beams	Response Time (Tr)
300 mm (11.8")	SLSCE14-300Q8	SLSCR14-300Q8	SLSCP14-300Q88	40	15 ms
450 mm (17.7")	SLSCE14-450Q8	SLSCR14-450Q8	SLSCP14-450Q88	60	19 ms
600 mm (23.6")	SLSCE14-600Q8	SLSCR14-600Q8	SLSCP14-600Q88	80	23 ms
750 mm (29.5")	SLSCE14-750Q8	SLSCR14-750Q8	SLSCP14-750Q88	100	27 ms
900 mm (35.4")	SLSCE14-900Q8	SLSCR14-900Q8	SLSCP14-900Q88	120	32 ms
1050 mm (41.3")	SLSCE14-1050Q8	SLSCR14-1050Q8	SLSCP14-1050Q88	140	36 ms
1200 mm (47.2")	SLSCE14-1200Q8	SLSCR14-1200Q8	SLSCP14-1200Q88	160	40 ms
1350 mm (53.1")	SLSCE14-1350Q8	SLSCR14-1350Q8	SLSCP14-1350Q88	180	43 ms
1500 mm (59.0")	SLSCE14-1500Q8	SLSCR14-1500Q8	SLSCP14-1500Q88	200	48 ms
1650 mm (65.0")	SLSCE14-1650Q8	SLSCR14-1650Q8	SLSCP14-1650Q88	220	52 ms
1800 mm (70.9")	SLSCE14-1800Q8	SLSCR14-1800Q8	SLSCP14-1800Q88	240	56 ms

*150 mm SLSC.. systems not available.

† Only standard 8-pin QD models are listed; 8-pin emitters/receivers feature "swapable" hookup; see Sections 3.3 and 3.7.

For other models:

5-pin emitters with Test input: Replace suffix "Q8" with "Q5", (e.g., SLSCE14-150Q5), and for the pair replace "Q88" with "Q85" (e.g., SLSCP14-150Q85).

Important: If a 5-pin emitter is used in the first ("master") position in a cascaded system, then 5-pin emitters must be used in all other positions in that cascade.

Pigtail QD (8-pin models only): Replace the "Q" in the model number with "P" (e.g., SLSCE14-150P8).

ESD-safe models: Add "N" to the model number, prior to the QD option designation (e.g., SLSCE14-150NQ8). ESD-safe models are not available with the pigtail QD option.

Optional housing finishes: Prior to the QD designation in the model number, add "A" for a clear (brushed) anodized aluminum finish, black endcaps (e.g., SLSCE14-150AQ8), add "S" for a nickel-plated ("silver") finish, black endcaps (e.g., SLSCE14-150SQ8), add "B" for a black painted finish, black endcaps (e.g., SLSCE14-150BQ8), add "W" for a white painted finish, black endcaps (e.g., SLSCE14-150WQ8), or add "SO" for a "safety orange" painted finish, black endcaps (e.g., SLSCE14-150SOQ8).

7.3 Cascadeable Emitter and Receiver Models – 30 mm Resolution

For cabling options, see Section 2.3.

Machine interface/power cables (one per end sensor, two per pair): Use QDE-..D cables.

Sensor interconnect cables (one per cascaded sensor, two per pair): Use DEE2R-..D cables.

Defined Area Height*	30 mm Resolution Cascadeable Models† 0.1 m to 18 m (4" to 60') range				
	Emitter (8-pin)	Receiver	Emitter/Receiver Pair	Number of Beams	Response Time (Tr)
300 mm (11.8")	SLSCE30-300Q8	8SLSCR30-300Q8	SLSCP30-300Q88	20	11 ms
450 mm (17.7")	SLSCE30-450Q8	SLSCR30-450Q8	SLSCP30-450Q88	30	13 ms
600 mm (23.6")	SLSCE30-600Q8	SLSCR30-600Q8	SLSCP30-600Q88	40	15 ms
750 mm (29.5")	SLSCE30-750Q8	SLSCR30-750Q8	SLSCP30-750Q88	50	17 ms
900 mm (35.4")	SLSCE30-900Q8	SLSCR30-900Q8	SLSCP30-900Q88	60	19 ms
1050 mm (41.3")	SLSCE30-1050Q8	SLSCR30-1050Q8	SLSCP30-1050Q88	70	21 ms
1200 mm (47.2")	SLSCE30-1200Q8	SLSCR30-1200Q8	SLSCP30-1200Q88	80	23 ms
1350 mm (53.1")	SLSCE30-1350Q8	SLSCR30-1350Q8	SLSCP30-1350Q88	90	25 ms
1500 mm (59.0")	SLSCE30-1500Q8	SLSCR30-1500Q8	SLSCP30-1500Q88	100	27 ms
1650 mm (65.0")	SLSCE30-1650Q8	SLSCR30-1650Q8	SLSCP30-1650Q88	110	30 ms
1800 mm (70.9")	SLSCE30-1800Q8	SLSCR30-1800Q8	SLSCP30-1800Q88	120	32 ms
1950 mm (76.8")	SLSCE30-1950Q8	SLSCR30-1950Q8	SLSCP30-1950Q88	130	34 ms
2100 mm (82.7")	SLSCE30-2100Q8	SLSCR30-2100Q8	SLSCP30-2100Q88	140	36 ms
2250 mm (88.6")	SLSCE30-2250Q8	SLSCR30-2250Q8	SLSCP30-2250Q88	150	38 ms
2400 mm (94.5")	SLSCE30-2400Q8	SLSCR30-2400Q8	SLSCP30-2400Q88	160	40 ms

*150 mm SLSC.. systems not available.

† Only standard 8-pin QD models are listed; 8-pin emitters/receivers feature "swapable" hookup; see Sections 3.3 and 3.7.

For other models:

5-pin emitters with Test input: Replace suffix "Q8" with "Q5", (e.g., SLSCE30-150Q5), and for the pair replace "Q88" with "Q85" (e.g., SLSCP30-150Q85).

Important: If a 5-pin emitter is used in the first ("master") position in a cascaded system, then 5-pin emitters must be used in all other positions in that cascade.

Pigtail QD (8-pin models only): Replace the "Q" in the model number with "P" (e.g., SLSCE30-150P8).

ESD-safe models: Add "N" to the model number, prior to the QD option designation (e.g., SLSCE30-150NQ8). ESD-safe models are not available with the pigtail QD option.

Optional housing finishes: Prior to the QD designation in the model number, add "A" for a clear (brushed) anodized aluminum finish, black endcaps (e.g., SLSCE30-150AQ8), add "S" for a nickel-plated ("silver") finish, black endcaps (e.g., SLSCE30-150SQ8), add "B" for a black painted finish, black endcaps (e.g., SLSCE30-150BQ8), add "W" for a white painted finish, black endcaps (e.g., SLSCE30-150WQ8), or add "SO" for a "safety orange" painted finish, black endcaps (e.g., SLSCE30-150SOQ8).

7.4 Determining Interconnect Cable Lengths

The following cable length charts are possible combinations for each side of example cascaded systems. All cables are assumed to be 22 awg wire. Other lengths and combinations are

possible; please call factory for assistance.

As the machine interface cable lengthens, the voltage drop increases, which results in shorter possible interconnect cables to maintain supply voltage requirements at the cascaded sensor. See Section 2 for cables.

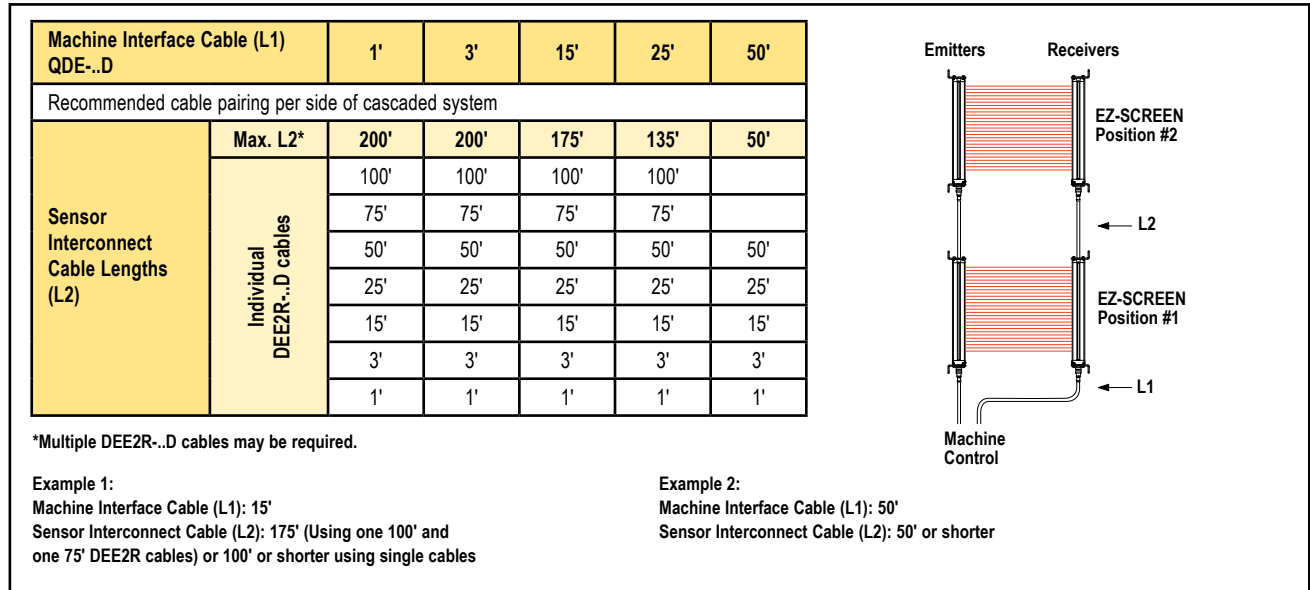

Figure 7-2. Cable length options for two cascaded light screens

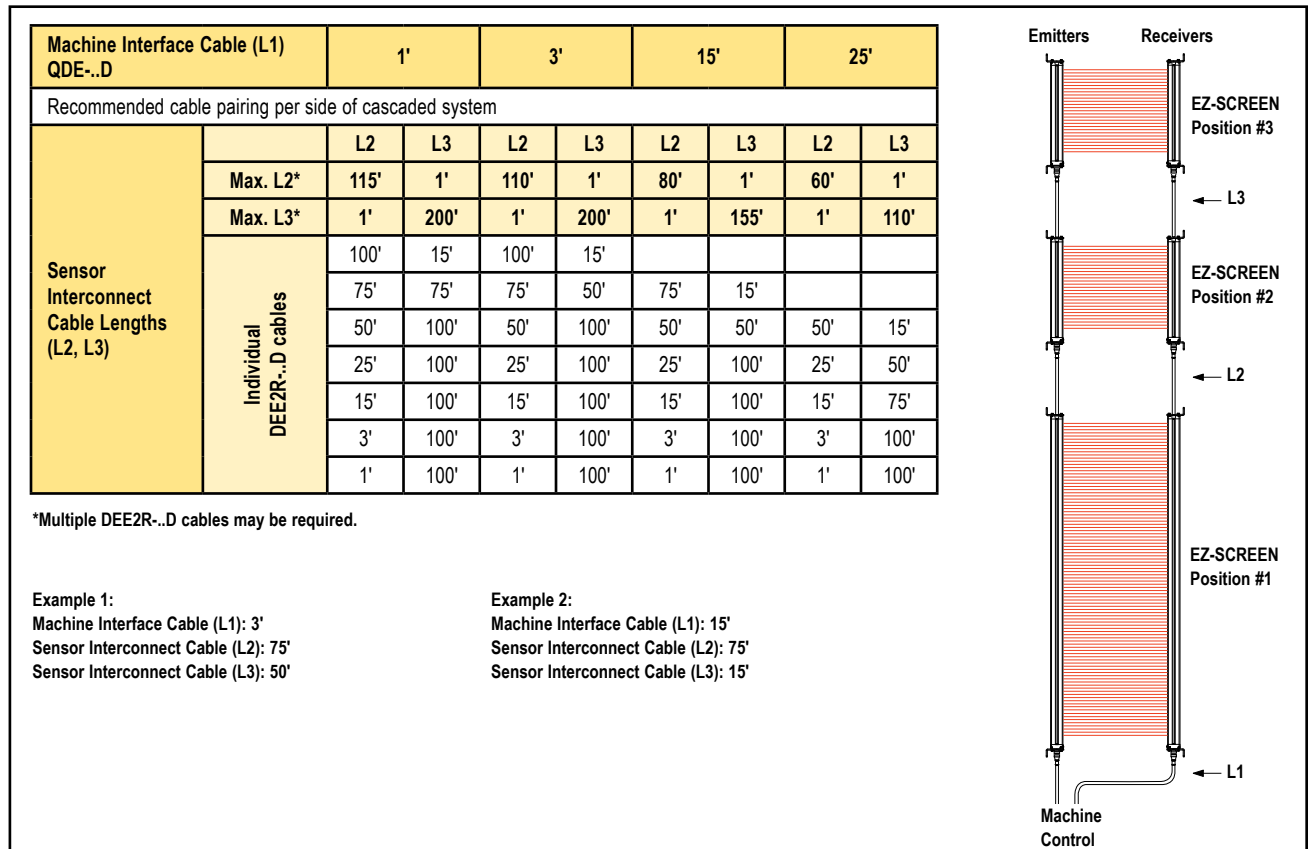

Figure 7-3. Cable length options for three cascaded light screens

Due to the large number of possible combinations, the table in Figure 7-4 includes only applications in which L2 = L4. A common installation example is one that protects two areas of a machine (e.g., the front and back of a power press) and uses four EZ-SCREEN pairs to create two "L"-shaped sensing fields.

Machine Interface Cable (L1) QDE-..D		1'			3'			15'			25'			
Recommended cable pairing per side of cascaded system														
Sensor Interconnect Cables (L2, L3 and L4)	Max. L3*	L2	L3	L4	L2	L3	L4	L2	L3	L4	L2	L3	L4	
		1'	110'	1'	1'	105'	1'	1'	75'	1'	1'	45'	1'	
	Individual DEE2R-..D cables	50'	15'	50'	50'	15'	50'							
		25'	50'	25'	25'	50'	25'	25'	25'	25'	25'			
		15'	75'	15'	15'	75'	15'	15'	25'	15'	15'	15'	15'	15'
		3'	100'	3'	3'	100'	3'	3'	50'	3'	3'	25'	3'	3'
1'	100'	1'	1'	100'	1'	1'	75'	1'	1'	25'	1'	1'		

*Multiple DEE2R-..D cables may be required.

Example 1:

- Machine Interface Cable (L1): 15'
- Sensor Interconnect Cable (L2): 1'
- Sensor Interconnect Cable (L3): 75'
- Sensor Interconnect Cable (L4): 1'

Example 2:

- Machine Interface Cable (L1): 15'
- Sensor Interconnect Cable (L2): 3'
- Sensor Interconnect Cable (L3): 50'
- Sensor Interconnect Cable (L4): 3'

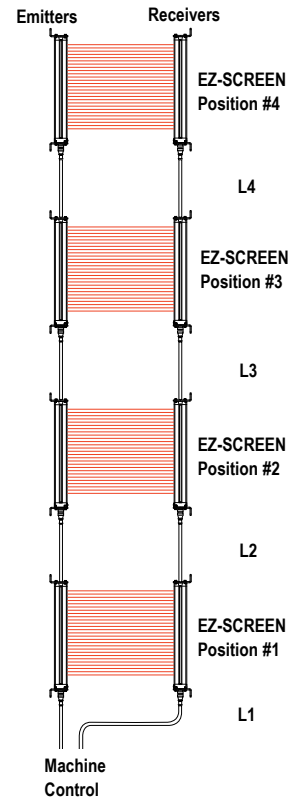

Figure 7-4. Cable length options for four cascaded light screens

7.5 Response Time for Cascaded Light Screens

Response time is an important factor in determining a light screen's separation (safety) distance. For cascaded (or "daisy-chained") EZ-SCREEN systems, that response time is dependent on the number of light screens, the number of beams in the light screens, and their positions in the cascade. It can be calculated easily, in two ways:

- Individually for each light screen in the cascade (separation distance is calculated for each light screen in the cascade), or
- Based on the worst-case time for the entire cascade (all light screens in the cascade have the same separation distance).

Individual Response Time and Separation Distance

When calculating individual separation distance for each emitter/receiver pair, the pair's position in the cascade impacts its response time, which then impacts its separation distance. This method results in the closest possible separation distance for each light screen.

Response time depends on how far "downstream" the light screen is from the machine control. Each light screen position in the cascade, starting from the first light screen in the cascade, increases the light screen's response time by 2 ms.

Figure 7-5 depicts a four-pair cascaded system. The 14 mm resolution, 300 mm EZ-SCREEN emitter/receiver pairs each begin with a response time of 15 ms. The pair in position #1 (connected directly to the machine control), maintains its 15 ms response time. Response time for the second pair in the cascade circuit increases by 2 ms, to 17 ms; for the third pair by 4 ms, to 19 ms, and for the fourth pair by 6 ms, to 21 ms. The formula used for U.S. applications (other standards may apply) to calculate separation distance for *individual placement of each emitter/receiver pair* in the cascaded system is:

$$\text{Position \#1: } D_s = K (T_s + T_r) + D_{pf}$$

$$\text{Position \#2: } D_s = K (T_s + T_r + 2 \text{ ms}) + D_{pf}$$

$$\text{Position \#3: } D_s = K (T_s + T_r + 4 \text{ ms}) + D_{pf}$$

$$\text{Position \#4: } D_s = K (T_s + T_r + 6 \text{ ms}) + D_{pf}$$

Use the above formulas in place of the D_s formula in Section 3.1.1 to determine *individual separation distance* (D_s). This will ensure each sensor pair is located at an adequate distance from the hazard.

WARNING . . . Proper Installation

The user must comply with all instructions within Section 3 for proper installation. See Sections 7.2 and 3.1.1 for complete information.

Overall Response Time and Separation Distance

The cascaded system's Overall Response Time (T_r) is equal to the response time of the individual sensor pair with the most beams (i.e., the slowest individual response time), plus an adder resulting from the number of systems in the cascade. T_r can be found by the following formula:

$$T_r = T_{r(\max)} + [(N-1) \times 2 \text{ ms}]$$

where:

$T_{r(\max)}$ is the response time of the slowest individual pair in the cascade (i.e., the pair with the most beams; see Section 7.2).

N is the number of sensor pairs in the cascade.

Use this T_r value in the formula in Section 3.1.1 to determine Overall Separation Distance (D_s). This will ensure that all sensor pairs will be located at an adequate distance from the hazard, no matter how the system is installed.

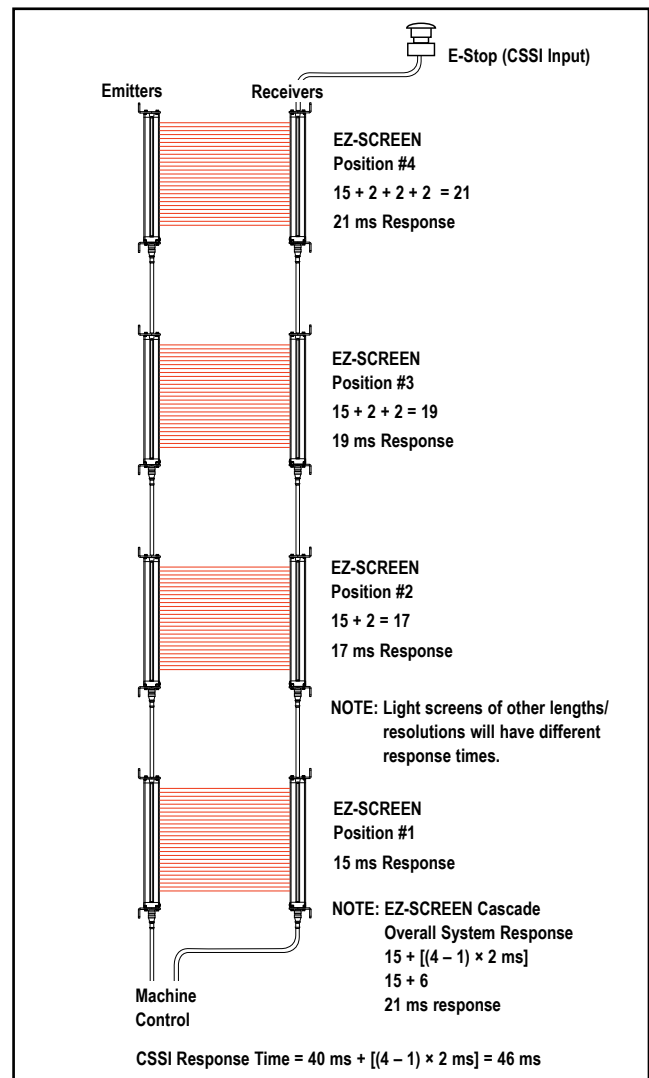

Figure 7-5. Calculating the individual response times of four, 14 mm resolution, 300 mm cascaded Safety Light Screens

When contacts (e.g., an E-stop button) are connected to a cascaded receiver (per Section 7.8), CSSI response time is 40 ms plus the 2 ms adder similar to the defined area Tr.

$$Tr_{(CSSI)} = 40 \text{ ms} + [(N-1) \times 2 \text{ ms}]$$

Cascade Configuration vs. Response Time

When light screens of different lengths or different resolutions (and therefore different response times) are used in one circuit, their positions in the cascade may become a consideration.

For example, consider the light screen circuits depicted in Figure 7-6. Each example contains three safety light screens, one 1200 mm (with a response time of 40 ms), and two 300 mm light screens (15 ms response each). Depending on their placement in the cascade, the individual response time for the same three light screens can vary from 40 to 44 ms.

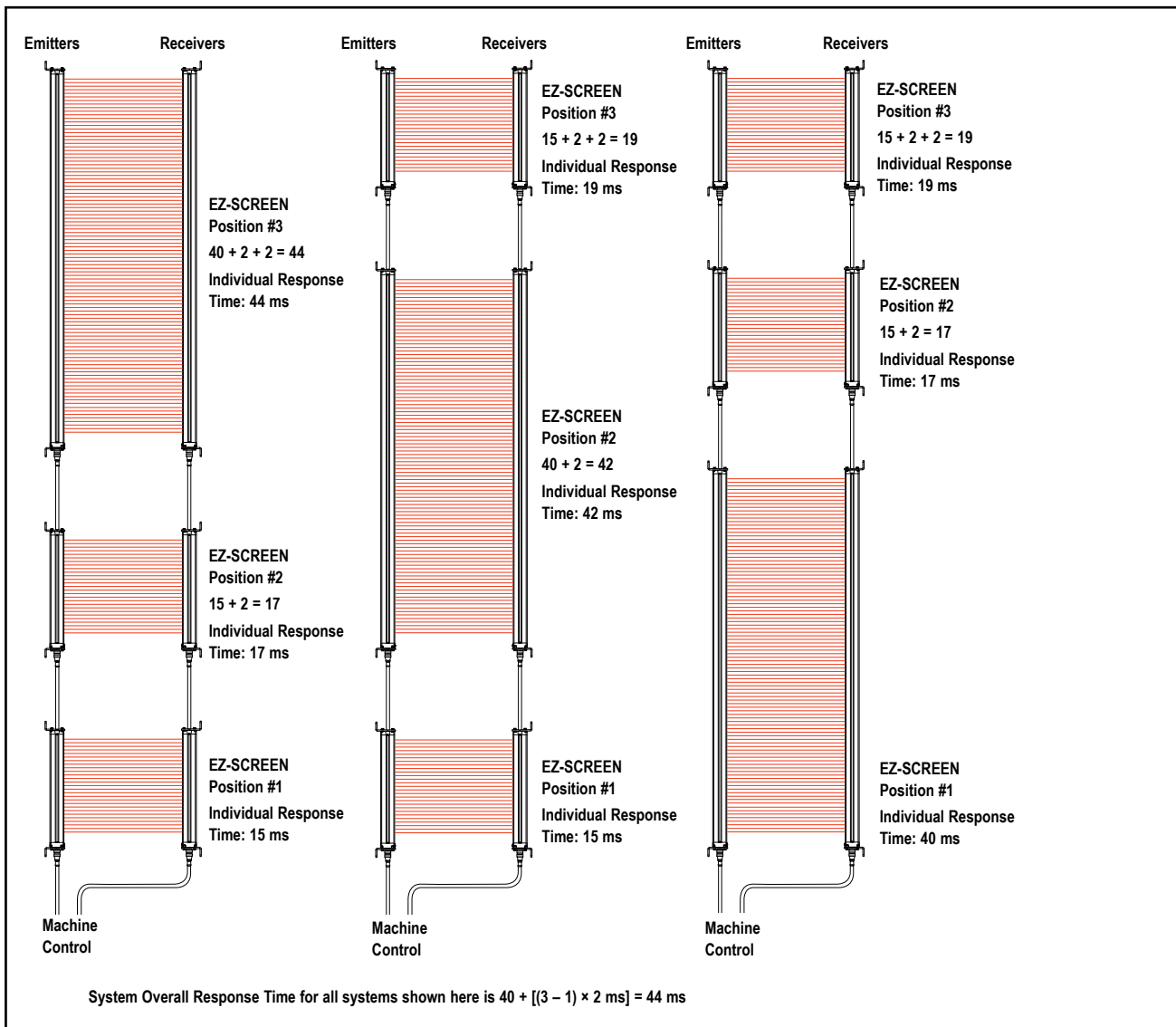

Figure 7-6. Calculating response times for a three-light screen cascade – both Individual and Overall methods

7.6 Cascaded Sensor Configuration Settings

Setting cascaded sensors for scan code, trip or latch output, external device monitoring (EDM), reduced resolution, fixed blanking and inverted display is identical to the procedure for non-cascadeable emitters and receivers (see Section 4).

Scan codes for each emitter and receiver pair must match. However, for cascaded installations, scan codes must alternate on adjacent systems as described in Section 3.1.8 and Figure 3-8. **See warning below.**

While the scan code, reduced resolution, fixed blanking, and inverted display settings are independent for each cascaded sensor pair, the trip/latch mode and EDM settings must be determined by the first receiver in the cascade (closest to the machine interface), which controls the OSSD outputs. **All other receivers in the cascade must be set for trip mode and 2-channel EDM (factory default settings).**

The settings on the first receiver then determine trip or latch mode and 1- or 2-channel EDM/aux. output, and this is the only receiver that requires a reset following a latch condition.

7.6.1 Fixed Blanking

One or more areas within any cascaded EZ-SCREEN sensor pair can be blanked out, just as with other EZ-SCREEN light screens. **Each sensor pair within a cascade must be programmed separately, if required.** See Section 3.4.3 for more information and programming procedure.

7.7 Configuration for Cascaded Operation

Each cascaded system must be configured, before it can be run in a production environment.

Before configuration, install all emitters and receivers per Sections 3 and 7. **The last receiver must be terminated either with a terminator plug or by connecting two closed mechanical contacts** (see Sections 7.8 and 7.9).

⚠ WARNING . . . Scan Code

In situations where multiple systems are mounted closely together, or where a secondary emitter is in view (within $\pm 5^\circ$), within range of an adjacent receiver; the adjacent systems must be configured for different Scan Codes (i.e., one system set for Scan Code 1 and the other for Scan Code 2).

If not, a receiver may synchronize to the signal from the wrong emitter, reducing the safety function of the light screen.

This situation will be discovered by performing the trip test (see Section 3.4.3).

Perform the following procedure on the first receiver only in the cascade (closest to the machine interface).

- From either normal operation or a power OFF condition, set the second and fifth DIP switches (RR and T/L) both to the left (RR and T position).
- Set the third and fourth DIP switches (the second T/L and RR) both to the right (L and OFF position); see Figure 7-7.
- The receiver should be in a lockout condition or power OFF.
- If power is OFF:** Apply power
Lockout condition: Perform a valid reset sequence (close the reset switch for 0.25 to 2 seconds, then reopen).
- Coming out of lockout or during startup, the DIP switch configuration will be recognized as Cascaded Teach Mode, indicated by the following:
 - First receiver display shows
No E-stop connected: "4C," "3C," or "2C" ON steady
E-stop w/closed contacts: "4CE," "3CE," or "2CE" ON steady
E-stop w/open contacts: "4CE," "3CE" or "2CE" flashing
 - Last cascaded receiver display shows
Terminator connected: "1C" ON steady
E-stop w/closed contacts: "1CE" ON steady
E-stop w/open contacts: "1CE" flashing
 - Other receivers display "1C" ON steady
 - All receiver Zone indicators OFF
 - All receiver Yellow reset indicators OFF
 - All receiver Status indicators solid red
- To enable and exit Cascade Teach Mode, reconfigure DIP switches for normal operation.
- Perform a valid reset sequence (see Step 4), or cycle power.

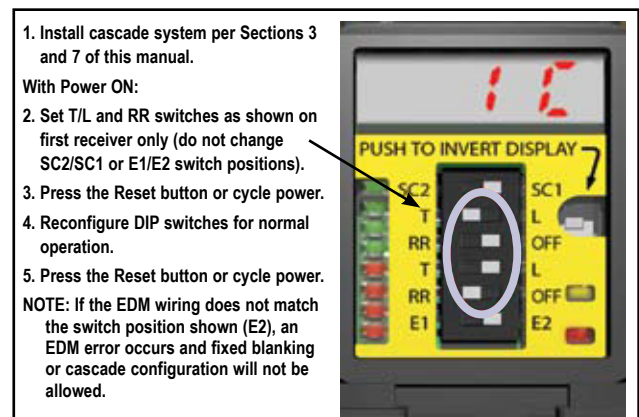

Figure 7-7. DIP switch configuration to enable cascade installation

7.8 Emergency Stop Buttons and Rope/Cable Pulls

Cascadeable EZ-SCREEN receivers may be connected to one or more E-stop buttons. The button(s) must connect to the end of the last receiver in the cascade, in place of the terminator plug.

The connected E-stop button(s) will activate/deactivate the OSSD outputs in all receivers in the cascade.

The number of E-stop buttons allowed in a series connection is limited by the total resistance per channel. The total resistance is the sum of all contact resistance values in the channel, plus the total wire resistance in the channel. The maximum total resistance per channel is 100 Ohms.

NOTE: The simultaneity between the two E-stop contacts, on opening and closing, is 3 seconds. If simultaneity is not met on either opening or closing, the first receiver's display will flash "|--|." If simultaneity is not met on opening, the closed contact can be opened later (after more than 3 seconds), then both contacts must be closed again.

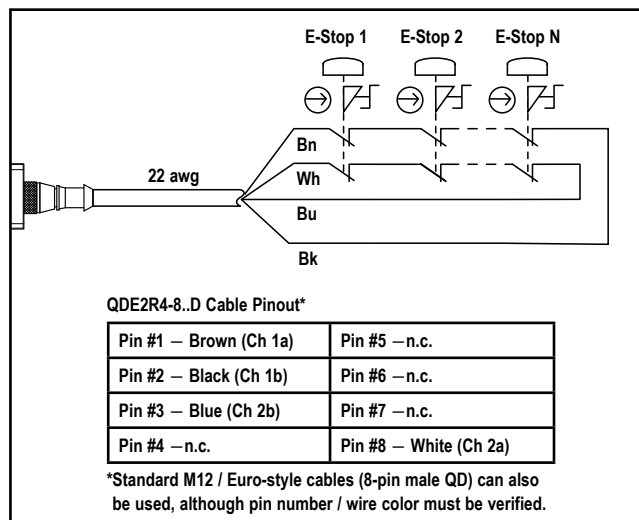

Figure 7-8. Hookup of E-stop buttons to the last receiver in the cascade

WARNING . . . Emergency Stop Functions

If Cascade Input is used for an Emergency Stop function, do not mute or bypass the safety outputs (OSSDs) of the EZ-SCREEN. NFPA79 requires that the Emergency Stop function remain active at all times. **Muting or bypassing the safety outputs will render the Emergency Stop function ineffective.**

E-Stop Switch Requirements (Positive-Opening)

As shown in Figure 7-8, the E-stop switch must provide two contact pairs, which are closed when the switch is in the "armed" position. Once activated, the E-stop switch must open its contacts and return to the closed-contact position only after

WARNING . . . Multiple E-Stop Switches

- Whenever two or more E-stop switches are connected to the same EZ-SCREEN receiver, the contacts of the E-stop switches must be connected together in series. This series combination is then wired to the respective EZ-SCREEN receiver input.

Never connect the contacts of multiple E-stop switches in parallel to the EZ-SCREEN inputs; this defeats the switch contact monitoring ability of the EZ-SCREEN light curtain, and creates an unsafe condition which could result in serious bodily injury or death.

- Also, when two or more E-stop switches are used, each switch must be individually actuated (engaged), then re-armed and the EZ-SCREEN light curtain reset (if using latch mode). This allows the monitoring circuits to check each switch and its wiring to detect faults. **Failure to test each switch individually in this manner could result in undetected faults and create an unsafe condition which could result in serious bodily injury or death.**

deliberate action (such as twisting, pulling, or unlocking). The switch should be a "positive-opening type," as described by IEC947-5-1. A mechanical force applied to such a button (or switch) is transmitted directly to the contacts, forcing them open. This ensures that the switch contacts will open whenever the switch is activated. ANSI/NFPA 79 specifies the following additional requirements:

- Emergency Stop push buttons shall be located at each operator control station and at other operating stations where emergency shutdown shall be required.
- Stop and Emergency Stop push buttons shall be continuously operable from all control and operating stations where located.
- Actuators of Emergency Stop devices shall be colored Red. The background immediately around the device actuator shall be colored Yellow. The actuator of a push-button-operated device shall be of the palm or mushroom-head type.
- The Emergency Stop actuator shall be a self-latching type.

NOTE: Some applications may have additional requirements.
The user must comply with all relevant regulations.

WARNING . . . Reset Routine Required

U.S. and international standards require that a reset routine be performed after returning the E-stop switch to its closed-contact position (when arming the E-stop switch). When automatic reset is used, an alternate means must be established to require a reset routine, after the E-stop switch is armed. **Allowing the machine to restart as soon as the E-stop switch is armed creates an unsafe condition which could result in serious injury or death.**

7.9 Positive-Opening Safety Interlock Switches

The Cascade input may be used to monitor interlock safety gates or guards. Requirements vary widely for the level of control reliability or safety category (per ISO 13849-1) in the application of interlocked guards. While Banner Engineering recommends the highest level of safety in any application, it is the responsibility of the user to safely install, operate, and maintain each safety system and comply with all relevant laws and regulations. Of the following applications, Figure 7-9 meets or exceeds the requirements for OSHA control reliability and Safety Category 4, per ISO 13849-1.

⚠ WARNING . . . Unguarded Moving Parts

It must not be possible for personnel to reach any hazard point through an opened guard (or any opening) before hazardous machine motion has completely stopped.

Please reference OSHA CFR1910.217, ANSI B11 standards, or other appropriate standards for information on determining safety distances and safe opening sizes for your application (see Inside back cover).

Interlock Guarding Requirements

The following general requirements and considerations apply to the installation of interlocked gates and guards for the purpose of safeguarding. In addition, the user must refer to the relevant regulations to be sure to comply with all necessary requirements.

Hazards guarded by the interlocked guard must be prevented from operating until the guard is closed; a Stop command must be issued to the guarded machine if the guard opens while the hazard is present. Closing the guard must not, by itself, initiate hazardous motion; a separate procedure must be required to initiate the motion. The safety switches must not be used as a mechanical or end-of-travel stop.

The guard must be located an adequate distance from the danger zone (so the hazard has time to stop before the guard is opened sufficiently to provide access to the hazard), and it must open either laterally or away from the hazard, not into the safeguarded area. Depending on the application, an interlocked gate or door should not be able to close by itself and activate the interlocking circuitry (ANSI/RIA R15.06). In addition, the installation must prevent personnel from reaching over, under, around, or through the guard to the hazard. Any openings in the guard must not allow access to the hazard (see OSHA 29CFR1910.217 Table O-10 or the appropriate standard). The guard must be strong enough and designed to protect personnel and contain hazards within the guarded area, which may be ejected, dropped, or emitted by the machine.

The safety switches and actuators used with the Cascade must be designed and installed so that they cannot be easily defeated. They must be mounted securely, so that their physical position can not shift, using reliable fasteners that require a tool to remove. Mounting slots in the housings are for initial adjustment only; final mounting holes must be used for permanent location.

Positive-Opening Interlocking Safety Switches

Two individually mounted safety interlock switches are recommended for each guard to meet safety category 4, per ISO 13849-1, and must satisfy several requirements. Each switch must provide at minimum, one normally closed (N/C) electrically isolated contact to interface with the Cascade input (see Figure 7-9).

The contacts must be of “positive-opening” design, with one or more normally closed contacts rated for safety. Positive-opening operation causes the switch to be forced open, without the use of springs, when the switch actuator is disengaged or moved from its home position (see the Banner Safety Catalog for examples). In addition, the switches must be mounted in a “positive mode” to move/disengage the actuator from its home position and open the normally closed contact when the guard opens.

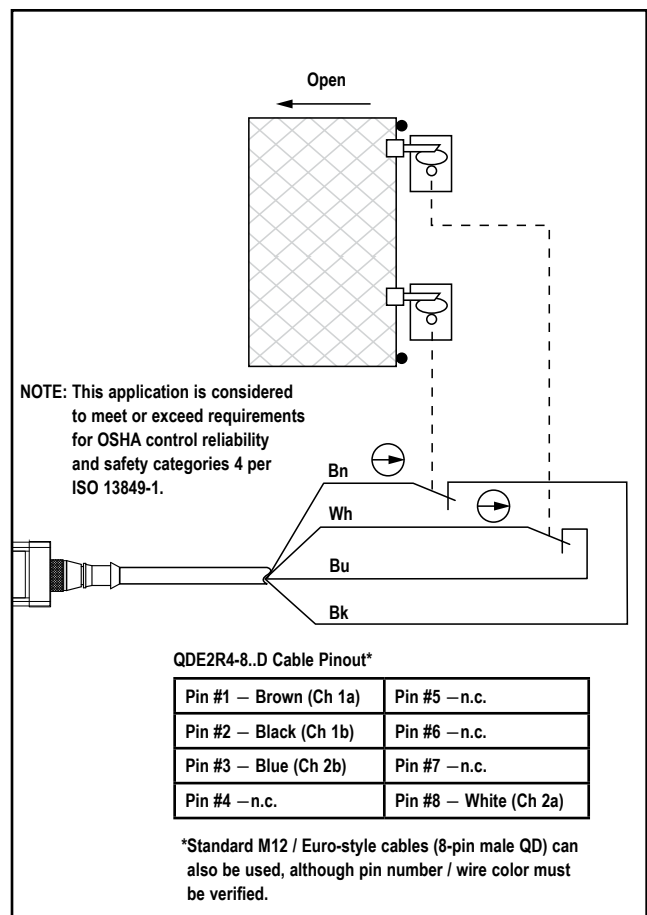

Figure 7-9. Monitoring two positive-opening safety switches

Monitoring Series-Connected Positive-Opening Safety Switches

When monitoring two individually mounted safety switches (as shown in Figure 7-9), a faulty switch will be detected if it fails to switch as the guard opens. In this case, the EZ-SCREEN will de-energize its OSSD output and disable its reset function until the input requirements are met (i.e., the faulty switch is replaced). However, when a series of interlocking safety switches is monitored by the EZ-SCREEN, the failure of one switch in the system may be masked or not detected at all (refer to Figure 7-10).

Series-connected, positive-opening interlock switch circuits do not meet ISO 13849-1 Safety Category 4 and may not meet Control Reliability requirements because of the potential of an inappropriate reset or a potential loss of the safety stop signal. A multiple connection of this type should not be used in applications where loss of the safety stop signal or an inappropriate reset could lead to serious injury or death. The following two scenarios assume two positive-opening safety switches on each guard:

1. **Masking of a failure.** If a guard is opened but a switch fails to open, the redundant safety switch will open and cause the EZ-SCREEN to de-energize its outputs. If the faulty guard is then closed, both Cascade input channels also close, but because one channel did not open, the EZ-SCREEN will not reset.

However, if the faulty switch is not replaced and a second “good” guard is cycled (opening and then closing both of the cascade input channels), the EZ-SCREEN considers the failure to be corrected. With the input requirements apparently satisfied, the EZ-SCREEN allows a reset. *This system is no*

longer redundant and, if the second switch fails, may result in an unsafe condition (i.e., the accumulation of faults results in the loss of the safety function).

2. **Non-detection of a failure.** If a good guard is opened, the EZ-SCREEN de-energizes its outputs (a normal response). But if a faulty guard is then opened and closed before the good guard is re-closed, the failure on the faulty guard is not detected. *This system also is no longer redundant and may result in a loss of safety if the second safety switch fails to switch when needed.*

The circuits in either scenario do not inherently comply with the safety standard requirements of detecting single faults and preventing the next cycle. In multiple-guard systems using series-connected positive-opening safety switches, it is important to periodically check the functional integrity of each interlocked guard individually. **Operators, maintenance personnel, and others associated with the operation of the machine must be trained to recognize such failures and be instructed to correct them immediately.**

Open and close each guard separately while verifying that the EZ-SCREEN outputs operate correctly throughout the check procedure. Follow each gate closure with a manual reset, if needed. If a contact set fails, the EZ-SCREEN will not enable its reset function. If the EZ-SCREEN does not reset, a switch may have failed; that switch must be immediately replaced.

This check must be performed and all faults must be cleared, at a minimum, during periodic checkouts. **If the application can not exclude these types of failures and such a failure could result in serious injury or death, then the safety switches must not be connected in series.**

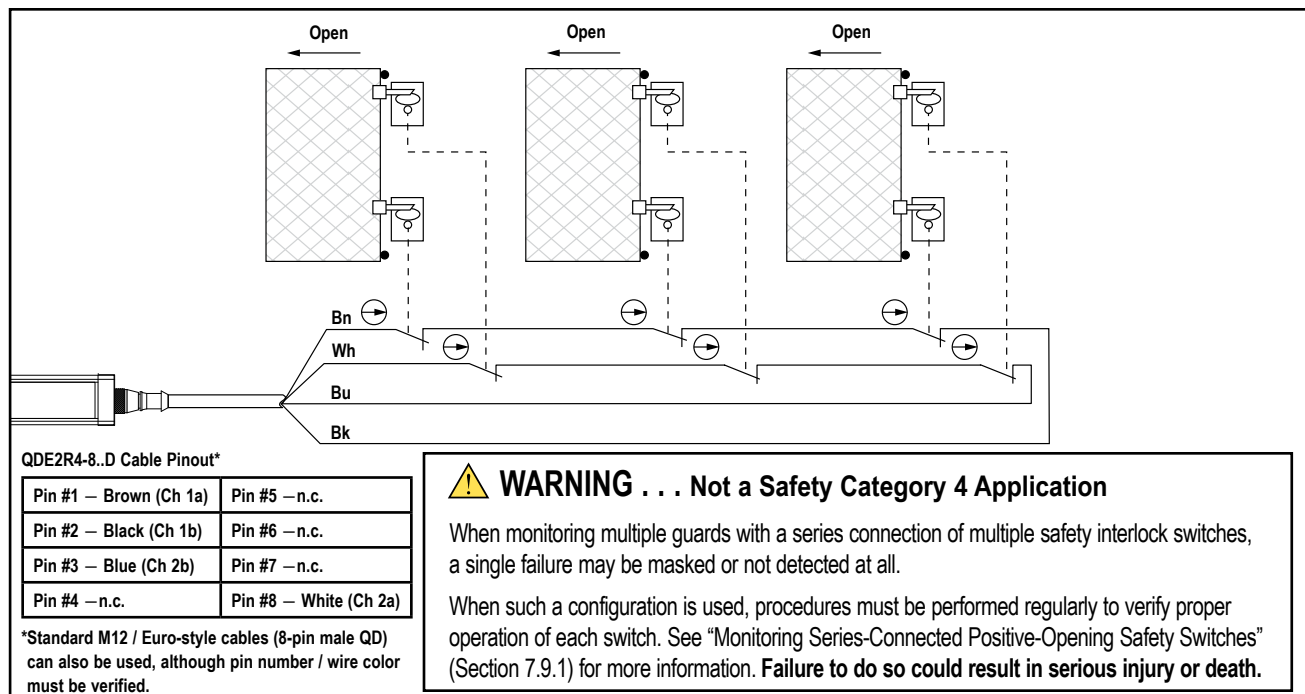

Figure 7-10. Monitoring positive-opening safety switches on multiple gates

Glossary of Terms

The following terms are used often in this manual. Where possible, this manual uses definitions from the U.S. and international product performance standards that govern the design of the Safety Controller. For more definitions, visit www.BannerEngineering.com/training/glossary.php.

ANSI (American National Standards Institute): Acronym for the American National Standards Institute, an association of industry representatives that develops technical standards (including safety standards). These standards comprise a consensus from a variety of industries on good practice and design. ANSI standards relevant to application of safety products include the ANSI B11 Series, and ANSI/RIA R15.06. See "Safety Standards" on inside back cover.

Auto Power-Up: A safety light screen system feature that enables the system to be powered up into RUN mode (or recover from a power interruption) without requiring a manual reset.

Blanking: A programmable feature of a safety light screen system which allows the light screen to ignore certain objects located within the defined area. See *fixed blanking*, *Floating Blanking*, and *Reduced Resolution*.

Blocked Condition: A condition that occurs when an opaque object of sufficient size blocks/interrupts one or more light screen beams. When a blocked condition occurs, OSSD1 and OSSD2 outputs simultaneously turn off within the system response time.

Brake: A mechanism for stopping, slowing, or preventing motion.

Cascade: Series connection (or "daisy-chaining") of multiple emitters and receivers.

CE: Abbreviation for "Conformité Européenne" (French translation of "European Conformity"). The CE mark on a product or machine establishes its compliance with all relevant European Union (EU) Directives and the associated safety standards.

Clutch: A mechanism that, when engaged, transmits torque to impart motion from a driving member to a driven member.

Control Reliability: A method of ensuring the performance integrity of a control system or device. Control circuits are designed and constructed so that a single failure or fault within the system does not prevent the normal stopping action from being applied to the machine when required, or does not create unintended machine action, but does prevent initiation of successive machine action until the failure is corrected.

CSA: Abbreviation for Canadian Standards Association, a testing agency similar to Underwriters Laboratories, Inc. (UL) in the United States. A CSA-certified product has been type-tested and approved by the Canadian Standards Association as meeting electrical and safety codes.

Defined Area: The "screen of light" generated by a safety light screen system, defined by the height and the separation distance of the emitter and receiver. When the defined area is interrupted by an opaque object of a specified cross section, a Trip or Latch condition results.

Designated Person: An individual identified and designated in writing, by the employer, as being appropriately trained and qualified to perform a specified checkout procedure. (See *Qualified Person*.)

Emitter: The light-emitting component of a safety light screen system, consisting of a row of synchronized modulated LEDs. The emitter, together with the receiver (placed opposite), creates a "screen of light" called the *defined area*.

External Device Monitoring (EDM): A means by which a safety device (such as a safety light screen) actively monitors the state (or status) of external devices that may be controlled by the safety device. A lockout of the safety device will result if an unsafe state is detected in the external device. External device(s) may include, but are not limited to: MPCEs, captive contact relays/contactors, and safety modules.

Failure to Danger: A failure which delays or prevents a machine safety system from arresting dangerous machine motion, thereby increasing risk to personnel.

Final Switching Device (FSD): The component of the machine's safety-related control system that interrupts the circuit to the machine primary control element (MPCE) when the output signal switching device (OSSD) goes to the OFF-state.

Fixed Blanking: A programming feature that allows a safety light screen system to ignore objects (such as brackets or fixtures) which will always be present at a specific location within the defined area. The presence of these objects will not cause the system's safety outputs (e.g., Final Switching Devices) to trip or latch. If any fixed objects are moved within or removed from the defined area, a Lockout condition results.

Floating Blanking: See Reduced Resolution.

FMEA (Failure Mode and Effects Analysis): A testing procedure by which potential failure modes in a system are analyzed to determine their results or effects on the system. Component failure modes that produce either no effect or a Lockout condition are permitted; failures which cause an unsafe condition (a failure to danger) are not. Banner safety products are extensively FMEA tested.

Guarded Machine: The machine whose point of operation is guarded by the safety system.

Hard Guard: Screens, bars, or other mechanical barriers affixed to the frame of the machine intended to prevent entry by personnel into the hazardous area(s) of a machine, while allowing the point of operation to be viewed. The maximum size of openings is determined by the applicable standard, such as Table O-10 of OSHA 29CFR1910.217, also called a "fixed barrier guard."

Hazardous Area: An area that poses an immediate or impending physical hazard.

Hazard Point: The closest reachable point of the hazardous area.

Internal Lockout: A Lockout condition that is due to an internal safety system problem. Generally, indicated by the red Status indicator LED (only) flashing. Requires the attention of a *Qualified Person*.

Key Reset (Manual Reset): A key-operated switch used to reset a safety light screen system to RUN mode following a Lockout condition, or to enable machine operation following a Latch condition. Also refers to the act of using the switch.

Latch Condition: The response of the safety light screen Safety Outputs (e.g., OSSDs) when an object equal to or greater than the diameter of the specified test piece enters the defined area. In a Latch condition, safety outputs simultaneously de-energize and open their contacts. The contacts are held (latched) open until the object is removed from the defined area and a manual reset is performed. A latching output is used most often in perimeter guarding applications. (See *Trip Condition*.)

Lockout Condition: A safety light screen condition that is automatically attained in response to certain failure signals (an internal lockout). When a Lockout condition occurs, the safety light screen's safety outputs turn OFF; the failure must be corrected and a manual reset is required to return the system to RUN mode.

Machine Primary Control Element (MPCE): An electrically powered element, external to the safety system, which directly controls the machine's normal operating motion in such a way that the element is last (in time) to operate when machine motion is either initiated or arrested.

Machine Response Time: The time between the activation of a machine stopping device and the instant when the dangerous parts of the machine reach a safe state (are brought to rest).

Minimum Object Sensitivity (MOS): The minimum-diameter object that a safety light screen system can reliably detect. Objects of this diameter or greater will be detected anywhere in the defined area. A smaller object can pass undetected through the light if it passes exactly midway between two adjacent light beams. Also known as MODS (Minimum Object Detection Size). See also *Specified Test Piece*.

Muting: The automatic suspension of the safeguarding function of a safety device during a non-hazardous portion of the machine cycle.

OFF State: The state in which the output circuit is interrupted and does not permit the flow of current.

ON State: The state in which the output circuit is complete and permits the flow of current.

OSHA (Occupational Safety and Health Administration): A U.S. Federal agency, Division of the U.S. Department of Labor, that is responsible for the regulation of workplace safety.

OSSD: Output Signal Switching Device. The safety outputs that are used to initiate a stop signal.

Part-Revolution Clutch: A type of clutch that may be engaged or disengaged during the machine cycle. Part-revolution clutched machines use a clutch/brake mechanism, which can arrest machine motion at any point in the stroke or cycle.

Pass-Through Hazard: A situation that may exist when personnel pass through a safeguard (at which point the hazard stops or is removed), and then continue into the guarded area. At this point the safeguard may not be able to prevent an unexpected start or restart of the machine with personnel within the guarded area.

Point of Operation: The location of a machine where material or a workpiece is positioned and a machine function is performed upon it.

PSDI (Presence-Sensing Device Initiation): An application in which a presence-sensing device is used to actually start the cycle of a machine. In a typical situation, an operator manually positions a part in the machine for the operation. When the operator moves out of the danger area, the presence-sensing device starts the machine (no start switch is used). The machine cycle runs to completion, and the operator can then insert a new part and start another cycle. The presence-sensing device continually guards the machine. Single-break mode is used when the part is automatically ejected after the machine operation. Double-break mode is used when the part is both inserted (to begin the operation) and removed (after the operation) by the operator. PSDI is commonly confused with "Trip Initiate." PSDI is defined in OSHA CFR1910.217. Banner safety light screen systems may not be used as PSDI devices on mechanical power presses, per OSHA regulation 29 CFR 1910.217.

Qualified Person: An individual who, by possession of a recognized degree or certificate of professional training, or by extensive knowledge, training, and experience, has successfully demonstrated the ability to solve problems relating to the subject matter and work. (See *Designated Person*.)

Receiver: The light-receiving component of a safety light screen system, consisting of a row of synchronized phototransistors. The receiver, together with the emitter (placed opposite), creates a "screen of light" called the *defined area*.

Reduced Resolution: A feature that allows a safety light screen system to be configured to produce an intentionally disabled light beam(s) within the light screen, which increases the minimum object sensitivity. The disabled beam(s) appears to move up and down ("float") in order to allow the feeding of an object through the defined area at any point without tripping the safety outputs (e.g., OSSDs) and causing a Trip or Latch condition. Sometimes called "Floating Blanking."

Reset: The use of a manually operated switch to restore the safety outputs to the ON state from a lockout or a Latch condition.

Resolution: See Minimum Object Sensitivity.

Self-Checking (Circuitry): A circuit with the capability to electronically verify that all of its own critical circuit components, along with their redundant backups, are operating properly. Banner safety light screen systems and safety modules are self-checking.

Separation Distance (Safety Light Screen): The minimum distance required to allow the machine's hazardous motion to stop completely, before a hand (or other object) can reach the nearest hazard point. Measured from the midpoint of the defined area to the nearest hazard point. Factors that influence minimum separation distance include the machine stop time, the light screen system response time, and the light screen minimum object detection size.

Specified Test Piece: An opaque object of sufficient size used to block a light beam to test the operation of a safety light screen system. When inserted into any part of the defined area, it will place a system into a Trip or Latch condition. Banner supplies specified test pieces with each system. See also *Minimum Object Sensitivity*.

Supplemental Guarding: Additional safeguarding device(s) or hard guarding, used to prevent a person from reaching over, under, through or around the primary safeguard or otherwise accessing the guarded hazard.

Test Piece: An opaque object of sufficient size used to block a light beam to test the operation of a safety light screen system.

Trip Condition: The response of the safety outputs (e.g., OSSDs) of a safety light screen system when an object equal to or greater than the diameter of the specified test piece enters the defined area. In a Trip condition, the OSSDs simultaneously de-energize. A Trip condition clears (resets) automatically when the object is removed from the defined area. (See *Latch Condition*.)

Trip Initiate: The resetting of a safeguard causing the initiation of machine motion or operation. **Trip Initiate is not allowed as a means to initiate a machine cycle** per NFPA 79 and ISO 60204-1, and is commonly confused with *PSDI*.

UL (Underwriters Laboratory): A third-party organization that tests products for compliance with appropriate standards, electrical codes, and safety codes. Compliance is indicated by the UL listing mark on the product.

The list of standards below is included as a convenience for users of this Banner product. Inclusion of the standards below does not imply that the product complies specifically with any standard, other than those specified in the Specifications section of this manual.

SOURCES

OSHA Documents

**Superintendent of Documents
Government Printing Office**
P.O. Box 371954
Pittsburgh, PA 15250-7954
Tel: (202) 512-1800
<http://www.osha.gov>

ANSI Accredited Standards

American National Standards Institute (ANSI)
11 West 42nd Street
New York, NY 10036
Tel: (212) 642-4900
<http://www.ansi.org>

B11 Documents

**Safety Director
The Association for Manufacturing
Technology (AMT)**
7901 Westpark Drive
McLean, VA 22102
Tel: (703) 893-2900
<http://www.mfgtech.org>

RIA Documents

Robotics Industries Association (RIA)
900 Victors Way, P.O. Box 3724
Ann Arbor, MI 48106
Tel: (734) 994-6088
<http://www.robotics.org>

NFPA Documents

National Fire Protection Association
1 Batterymarch Park
P.O. Box 9101
Quincy, MA 02269-9101
Tel: (800) 344-3555
<http://www.nfpa.org>

Alternate sources for these, plus ISO, IEC, EN, DIN, and BS Standards:

Global Engineering Documents

15 Inverness Way East
Englewood, CO 80112-5704
Tel: (800) 854-7179
<http://www.global.ihs.com>

National Standards Systems Network (NSSN)

25 West 43rd Street
New York, NY 10036
Tel: (212) 642-4980
<http://www.nssn.com>

Document Center, Inc.

111 Industrial Road, Suite 9
Belmont, CA 94002
Tel: (650) 591-7600
<http://www.document-center.com>

U.S. Application Standards

ANSI B11.1 Mechanical Power Presses	ANSI B11.16 Metal Powder Compacting Presses
ANSI B11.2 Hydraulic Power Presses	ANSI B11.17 Horizontal Extrusion Presses
ANSI B11.3 Power Press Brakes	ANSI B11.18 Machinery and Machine Systems for the Processing of Coiled Strip, Sheet, and Plate
ANSI B11.4 Shears	ANSI B11.19 Performance Criteria for Safeguarding
ANSI B11.5 Iron Workers	ANSI B11.20 Manufacturing Systems
ANSI B11.6 Lathes	ANSI B11.21 Machine Tools Using Lasers
ANSI B11.7 Cold Headers and Cold Formers	ANSI B11.22 Numerically Controlled Turning Machines
ANSI B11.8 Drilling, Milling, and Boring	ANSI B11.23 Machining Centers
ANSI B11.9 Grinding Machines	ANSI B11.24 Transfer Machines
ANSI B11.10 Metal Sawing Machines	ANSI B11.TR3 Risk Assessment
ANSI B11.11 Gear Cutting Machines	ANSI/RIA R15.06 Safety Requirements for Industrial Robots and Robot Systems
ANSI B11.12 Roll Forming and Roll Bending Machines	NFPA 79 Electrical Standard for Industrial Machinery
ANSI B11.13 Single- and Multiple-Spindle Automatic Bar and Chucking Machines	
ANSI B11.14 Coil Slitting Machines	
ANSI B11.15 Pipe, Tube, and Shape Bending Machines	

OSHA Regulations

OSHA Documents listed are part of: Code of Federal Regulations Title 29, Parts 1900 to 1910	OSHA 29 CFR 1910.147 The Control of Hazardous Energy (lockout/tagout)
OSHA 29 CFR 1910.212 General Requirements for (Guarding of) All Machines	OSHA 29 CFR 1910.217 (Guarding of) Mechanical Power Presses

International/European Standards

ISO 12100-1 & -2 (EN 292-1 & -2) Safety of Machinery – Basic Concepts, General Principles for Design	ISO 14121 (EN 1050) Principles of Risk Assessment
ISO 13852 (EN 294) Safety Distances . . . Upper Limbs	ISO 14119 (EN 1088) Interlocking Devices Associated with Guards – Principles for Design and Selection
ISO 13850 (EN 418) Emergency Stop Devices, Functional Aspects – Principles for Design	IEC 60204-1 Electrical Equipment of Machines Part 1: General Requirements
ISO 13851 (EN 574) Two-Hand Control Devices – Functional Aspects – Principles for Design	IEC 61496 Electro-sensitive Protection Equipment
ISO 13853 (prEN 811) Safety Distances . . . Lower Limbs	IEC 60529 Degrees of Protection Provided by Enclosures
ISO 13849-1 (EN 954-1) Safety-Related Parts of Control Systems	IEC 60947-1 Low Voltage Switchgear – General Rules
ISO 13855 (EN 999) The Positioning of Protective Equipment in Respect to Approach Speeds of Parts of the Human Body	IEC 60947-5-1 Low Voltage Switchgear – Electromechanical Control Circuit Devices
	IEC 60947-5-5 Low Voltage Switchgear – Electrical Emergency Stop Device with Mechanical Latching Function

Banner Engineering Corp Limited Warranty

Banner Engineering Corp. warrants its products to be free from defects in material and workmanship for one year following the date of shipment. Banner Engineering Corp. will repair or replace, free of charge, any product of its manufacture which, at the time it is returned to the factory, is found to have been defective during the warranty period. This warranty does not cover damage or liability for misuse, abuse, or the improper application or installation of the Banner product.

THIS LIMITED WARRANTY IS EXCLUSIVE AND IN LIEU OF ALL OTHER WARRANTIES WHETHER EXPRESS OR IMPLIED (INCLUDING, WITHOUT LIMITATION, ANY WARRANTY OF MERCHANTABILITY OR FITNESS FOR A PARTICULAR PURPOSE), AND WHETHER ARISING UNDER COURSE OF PERFORMANCE, COURSE OF DEALING OR TRADE USAGE.

This Warranty is exclusive and limited to repair or, at the discretion of Banner Engineering Corp., replacement. **IN NO EVENT SHALL BANNER ENGINEERING CORP. BE LIABLE TO BUYER OR ANY OTHER PERSON OR ENTITY FOR ANY EXTRA COSTS, EXPENSES, LOSSES, LOSS OF PROFITS, OR ANY INCIDENTAL, CONSEQUENTIAL OR SPECIAL DAMAGES RESULTING FROM ANY PRODUCT DEFECT OR FROM THE USE OR INABILITY TO USE THE PRODUCT, WHETHER ARISING IN CONTRACT OR WARRANTY, STATUTE, TORT, STRICT LIABILITY, NEGLIGENCE, OR OTHERWISE.**

Banner Engineering Corp. reserves the right to change, modify or improve the design of the product without assuming any obligations or liabilities relating to any product previously manufactured by Banner Engineering Corp.



X-ON Electronics

Largest Supplier of Electrical and Electronic Components

Click to view similar products for [banner manufacturer](#):

Other Similar products are found below :

[Q45VR2FPQ](#) [BTA23S](#) [RS-11](#) [L16F](#) [2LM3](#) [2PBA](#) [LM8-1](#) [LMT](#) [SM312CV](#) [SM31RQD](#) [LS4ELQ](#) [FX1](#) [Q45BB6LLQ](#) [QM42VP6AFV150Q](#)
[D12SP6FP](#) [MBCC-412](#) [BA23S](#) [BT21S](#) [BTA13S](#) [LM4-2](#) [QS18VN6DB](#) [ES-FA-6G](#) [T183E](#) [SLSP30-600Q88](#) [SLSP30-1200Q88](#) [OPBA5](#)
[PBAT](#) [CL50GRYNQ](#) [SBLV1](#) [SMA91EQD](#) [SMA91E](#) [SMA912LVQD](#) [SMA912DQD](#) [SM2A312CVQD](#) [SM2A912LVQD](#) [SM31RL](#)
[TL70RAQ](#) [TL70RQ](#) [K50LG RYPQ](#) [LEDRR70X70-78587](#) [BRT-THG-4X4-5](#) [T18-2VN DL-Q8](#) [UM-FA-11A](#) [SLLP14-1190P88](#) [SME312DQD](#)
[SM312CUQD](#) [BR-2](#) [BR23P](#) [SM2A312FPQD](#) [SM2A312LVQD](#)