

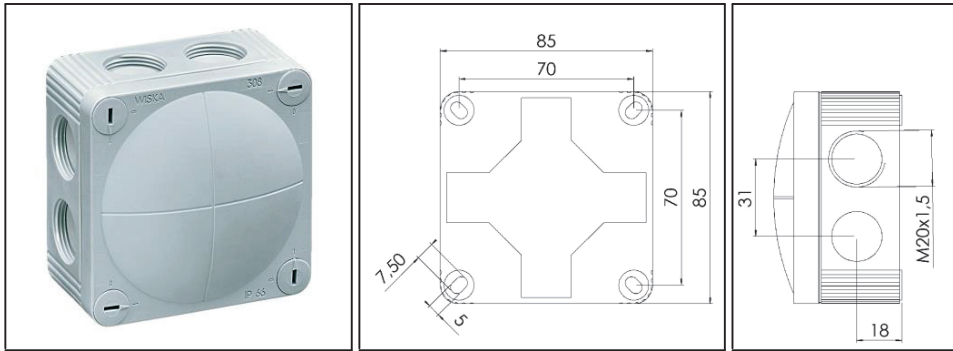







**WISKA COMBI 308**



**Protection class to EN 60 529:** IP 66  
**Flame protection:** Glow wire test 750 C acc. to EN 60695-2-11  
**Temperatures during installation:** -5°C to 60°C  
**Temperature range of material:** -30°C to 100°C, intermittent up to approx. 120°C  
**Voltage:** 400 V  
**Material:** Polypropylene, reinforced glass fibre; Sealing: thermoplastic elastomere  
**Terminals/poles:** 4 mm<sup>2</sup>  
**Fixing:** With mounting clip or 4 internal openings outside of the sealing area  
**Equipment:** 8 elastic self-sealing membranes for cable entry without mechanical devices  
 - 8 integrated M 20 threads, no locknuts necessary  
 - 4 captive quick-release lid screws  
 - Incl. mounting clip for snap-on fixing  
 - Colour RAL 7035 light grey  
 - .../S = black  
 - .../W = white

**Accessories:**  
 - DIN RAIL KIT 108, 308: Rail TS 15 + Fixing material, WISKA-No. 10060362  
 - EC 308 Earthing plate: WISKA No. 10101473

Type	WISKA-No.		 mm		L x B x H external / außen mm
COMBI 308/5	10060401	5/100	3 - 12		85 x 85 x 51
COMBI 308/5/S	10060580	5/100	3 - 12		85 x 85 x 51
COMBI 308/5/W	10060611	5/100	3 - 12		85 x 85 x 51
DIN RAIL KIT 308	10060362	1			

## **X-ON Electronics**

Largest Supplier of Electrical and Electronic Components

*Click to view similar products for [wiska manufacturer](#):*

Other Similar products are found below :

[10066414](#) [10065002](#) [EMUG 32 GRY](#) [RE0400](#) [COMBI 1010/5/S](#) [10100824](#) [COMBI 108/5](#) [ESMU 20](#) [COMBI 308/5/S](#) [COMBI 308/5](#)  
[10066124](#) [ESVG25 BLK](#) [EMMU 20](#) [10066120](#) [EMUG 25 BLK](#)