

Base strip - PTSM 0,5/ 3-HV-2,5-THR R32 - 1778560

Please be informed that the data shown in this PDF Document is generated from our Online Catalog. Please find the complete data in the user's documentation. Our General Terms of Use for Downloads are valid (<http://phoenixcontact.com/download>)



Header, Nominal current: 6 A, Rated voltage (III/2): 160 V, Number of positions: 3, Pitch: 2.5 mm, Color: black, Contact surface: Tin, Mounting: Taped SMD/THT/THR components

Product Features

- Compatible with PTSM.../PTPM... plugs
- High current carrying capacity of 6 A
- Supplied in tape-on-reel packing according to IEC 60286-3 for automated mounting
- Specifically designed for use in reflow/soldering processes



Key Commercial Data

Packing unit	1 pc
Minimum order quantity	330 pc
Weight per Piece (excluding packing)	1.88 g
Custom tariff number	85369010
Country of origin	India

Technical data

Dimensions

Length	5 mm
Pitch	2.50 mm
Dimension a	5 mm
Width	9.2 mm
Constructional height	7.5 mm
Height	9.5 mm
Length of the solder pin	2 mm
Pin dimensions	0,6 x 0,6 mm
Pin spacing	2.50 mm
Hole diameter	1.1 mm

Base strip - PTSM 0,5/ 3-HV-2,5-THR R32 - 1778560

Technical data

General

Range of articles	PTSM 0,5/..-HV-THR
Insulating material group	IIIa
Rated surge voltage (III/3)	2.5 kV
Rated surge voltage (III/2)	2.5 kV
Rated surge voltage (II/2)	2.5 kV
Rated voltage (III/3)	50 V
Rated voltage (III/2)	160 V
Rated voltage (II/2)	160 V
Connection in acc. with standard	EN-VDE
Nominal current I _N	6 A
Maximum load current	6 A
Insulating material	LCP
Flammability rating according to UL 94	V0
Color	black
Number of positions	3

Standards and Regulations

Connection in acc. with standard	EN-VDE
	UL
Flammability rating according to UL 94	V0

Classifications

eCl@ss

eCl@ss 4.0	272607xx
eCl@ss 4.1	27260701
eCl@ss 5.0	27260701
eCl@ss 5.1	27260701
eCl@ss 6.0	27260704
eCl@ss 7.0	27440402
eCl@ss 8.0	27440402

ETIM

ETIM 3.0	EC001121
ETIM 4.0	EC002637
ETIM 5.0	EC002637

Base strip - PTSM 0,5/ 3-HV-2,5-THR R32 - 1778560

Classifications

UNSPSC

UNSPSC 6.01	30211810
UNSPSC 7.0901	39121409
UNSPSC 11	39121409
UNSPSC 12.01	39121409
UNSPSC 13.2	39121409

Approvals

Approvals

Approvals

UL Recognized / UL Recognized / EAC

Ex Approvals

Approvals submitted

Approval details

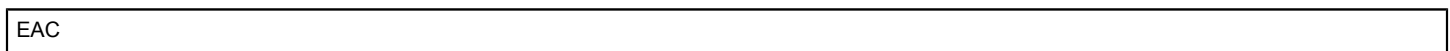
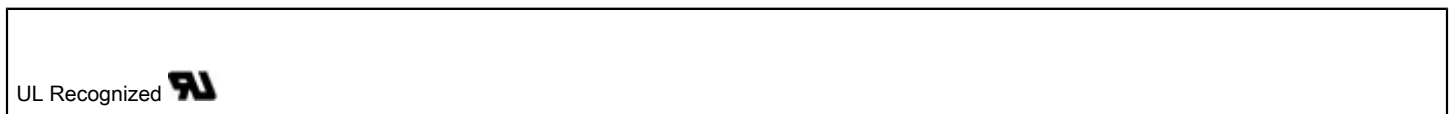
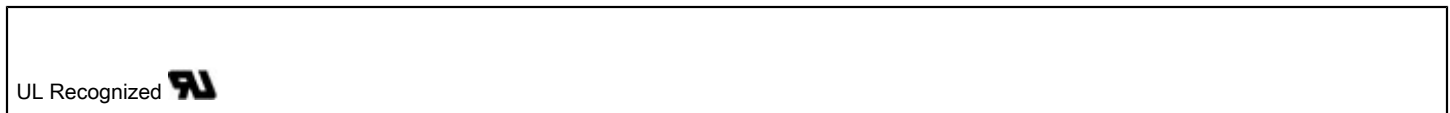

Drawings

Base strip - PTSM 0,5/ 3-HV-2,5-THR R32 - 1778560

Drilling diagram

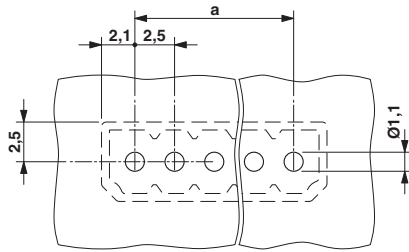

Diagram

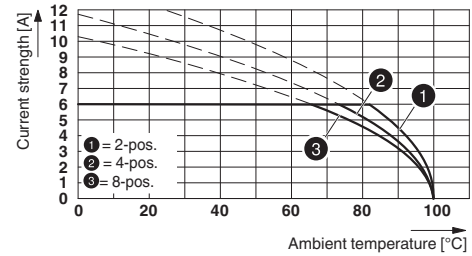

Derating curve for: PTSM 0,5/...-P-2,5 with PTSM 0,5/...-HV-2,5-THR R...

Dimensional drawing

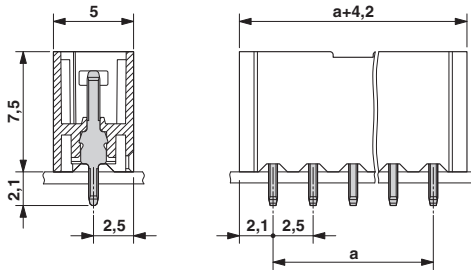

Dimensional drawing

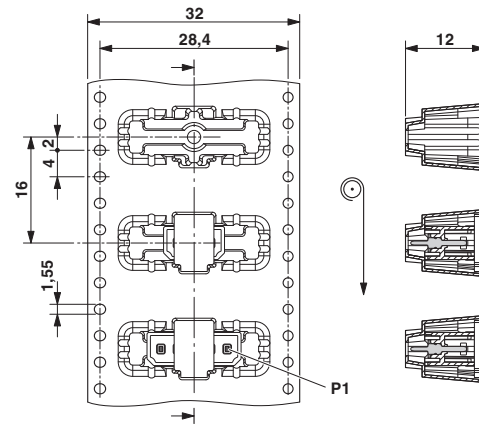

X-ON Electronics

Largest Supplier of Electrical and Electronic Components

Click to view similar products for [Headers & Wire Housings](#) category:

Click to view products by [Phoenix Contact](#) manufacturer:

Other Similar products are found below :

[95000-104TRLF](#) [10135584-644402LF](#) [DF62W-EP2022PCA](#) [95000-106TRLF](#) [DF62W-2022SCA](#) [DF62W-EP2022PC](#) [2203348](#) [DF62W-2022SC](#) [1084018](#) [1029039](#) [1084017](#) [802-10-012-10-002000](#) [1112640](#) [1112639](#) [891-007-9SS-BST1T](#) [000-34000](#) [0008550134](#) [0009482033](#) [0009507031](#) [57102-F02-18ULF](#) [57102-S06-03LF](#) [57202-S52-04LF](#) [PCN6-15S-2.5E](#) [0039019024](#) [58102-G61-06LF](#) [582553-1](#) [0009485154](#) [0009508121](#) [0022285053](#) [0050291907](#) [018731A](#) [LY20-4P-DT1-P1E-BR](#) [02.125.8002.8](#) [60101931](#) [60598-1 \(Cut Strip\)](#) [M1625-3R/100](#) [61062-3](#) [61082-181009](#) [CSU011177004](#) [636-1427](#) [638009-1](#) [641938-9](#) [641991-4](#) [644168-1](#) [644827-2](#) [647662-1](#) [65039-019ELF](#) [65692-001LF](#) [65781-018](#) [65781-047](#)