



# AkroBins®

## INDUSTRY-LEADING HANGING & STACKING BINS



MADE IN THE USA

### FEATURES

- 1 Anti-slide stop prevents stacked bins from shifting forward
- 2 Optional dividers allow you to create customizable compartment sizes
- 3 Full-width hanger lip supports bin on hanging system
- 4 Curved-bottom hopper front makes it easy to retrieve small parts
- 5 Reinforced side ribs add strength and prevent spreading when stacked
- 6 Large front label area for easy coding and scanning
- 7 Extra-wide stacking ledge provides stability, saves space and prevents spills

### PRODUCT HIGHLIGHTS

- **EFFICIENT** – Control inventories, shorten assembly times, minimize parts handling
- **FUNCTIONAL** – Heavy-duty bins securely stack atop each other, sit on shelving, and hang from Akro-Mils racks, panels, rails and carts
- **DURABLE** – Molded of industrial-grade polymers, AkroBins are resistant to weak acids and alkalis. Water, rust and corrosion-proof
- **VARIETY** – Available in 14 sizes and 7 Standard Colors: Red, Blue, Yellow, Stone, Green, Black and Clear! 4 Specialty Colors: Berry, Light Blue, Purple, Teal available in 9 sizes
- **GUARANTEED** – AkroBins are guaranteed not to crack or break under normal load conditions as stated in our 1-year limited warranty

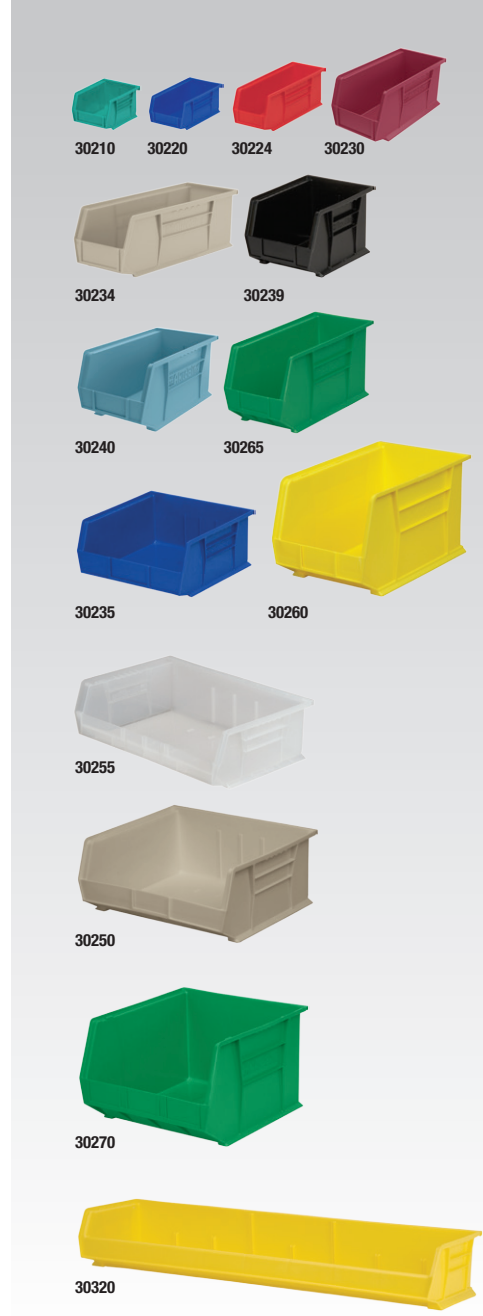

### STANDARD COLORS

Red, Yellow, Blue, Stone, Green, Clear, Black



### SPECIALTY COLORS

Berry, Light Blue, Purple, Teal



Also available in recycled Hunter Green, Sandstone and Terra Cotta. See Pg. 8.



800.253.2467  
akro-mils.com

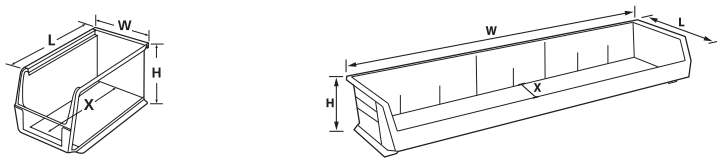

AkroBins Model No.	Outside Dimensions (In.)			Bottom Dimensions (In.)				Capacity/Quantity		Accessories							
	L	W	H	L	W	H	X	Bin Load Capacity On Rack	Bin Ctn. Qty.	Length Dividers**	Width Dividers**	Divider Pkg. Qty.	Bin Lids***	Lid Pkg. Qty.	Adhesive Labels	Card Stock	Slope-It Bin Inserts
30210*	5 $\frac{1}{8}$	4 $\frac{1}{8}$	3	4 $\frac{3}{8}$	3 $\frac{1}{8}$	2 $\frac{3}{8}$	4	10 lbs.	24	40210 (1)	-	6	30211CRY	24	29202	29301	-
30220*	7 $\frac{1}{8}$	4 $\frac{1}{8}$	3	6 $\frac{3}{8}$	3 $\frac{1}{8}$	2 $\frac{3}{8}$	6	10 lbs.	24	40220 (1)	-	6	30221CRY	24	29202	29301	-
30224*	10 $\frac{1}{8}$	4 $\frac{1}{8}$	4	10 $\frac{1}{4}$	3 $\frac{1}{8}$	3 $\frac{3}{8}$	9	30 lbs.	12	40224 (1)	-	-	30225CRY	12	29202	29301	46224
30230*	10 $\frac{1}{8}$	5 $\frac{1}{2}$	5	10 $\frac{1}{4}$	4 $\frac{1}{8}$	4 $\frac{3}{8}$	9	30 lbs.	12	40230 (1)	41230 (3)	6	30231CRY	12	29203	29302	46230
30234*	14 $\frac{1}{4}$	5 $\frac{1}{2}$	5	14 $\frac{1}{8}$	4 $\frac{1}{8}$	4 $\frac{3}{8}$	12 $\frac{3}{8}$	50 lbs.	12	40234 (1)	-	-	-	-	29203	29302	-
30239*	10 $\frac{1}{8}$	8 $\frac{1}{4}$	7	10	6 $\frac{1}{8}$	6 $\frac{3}{8}$	8	50 lbs.	6	40239 (1)	-	6	-	-	29203	29302	-
30240*	14 $\frac{1}{4}$	8 $\frac{1}{4}$	7	14	6 $\frac{1}{8}$	6 $\frac{3}{8}$	12	60 lbs.	12	40245 (1)	-	6	-	-	29203	29302	46240
30265	18	8 $\frac{1}{4}$	9	17 $\frac{1}{8}$	6 $\frac{1}{8}$	8 $\frac{1}{4}$	14 $\frac{1}{2}$	60 lbs.	6	40265 (1)	-	6	-	-	29203	29303	-
30235*	10 $\frac{1}{8}$	11	5	10 $\frac{1}{4}$	10	4 $\frac{3}{8}$	9	50 lbs.	6	40230 (3)	-	6	30236CRY	6	29203	29302	-
30260	18	11	10	17	9 $\frac{1}{2}$	9 $\frac{3}{8}$	14 $\frac{1}{8}$	60 lbs.	6	40260 (3)	-	6	-	-	29203	29303	-
30255	10 $\frac{1}{8}$	16 $\frac{1}{2}$	5	9 $\frac{3}{8}$	15	4 $\frac{3}{8}$	9	60 lbs.	6	40230 (3)	-	6	-	-	29203	29302	-
30250*	14 $\frac{1}{4}$	16 $\frac{1}{2}$	7	14	14 $\frac{1}{4}$	6 $\frac{3}{8}$	12	75 lbs.	6	40245 (3)	-	6	-	-	29203	29302	-
30270	18	16 $\frac{1}{2}$	11	17 $\frac{1}{8}$	14 $\frac{1}{4}$	10 $\frac{1}{4}$	14	75 lbs.	3	40270 (3)	-	6	-	-	29203	29303	-
30320	8 $\frac{1}{2}$	33	5	7	31 $\frac{1}{2}$	4 $\frac{3}{8}$	6	80 lbs.	4	40321 & 40220 (7)	-	7	30321	4	-	-	-

One color per carton: Specify Red, Blue, Yellow, Stone, Clear, Green or Black. Order in carton quantities. CAUTION: When using bins with hanging systems, do not exceed the weight capacity for the rack, which may be less than the total sum of bin capacities. 40321= Tall Divider; 40220=Short Divider. \*Available in Specialty Colors: Berry, Purple, Teal and Light Blue. \*\*() = Max. # of dividers per bin. \*\*\*Assembly required - 30211CRY replaces 30211; 30221CRY replaces 30221; 30231CRY replaces 30231; 30236CRY replaces 30236.

**ProHANGER**

30330RED	7 $\frac{3}{8}$	8 $\frac{1}{4}$	5	-	-	-	-	75 lbs.	6
40330	6 $\frac{1}{8}$	1 $\frac{1}{4}$	4 $\frac{1}{4}$	-	-	-	-	75 lbs.	6
403302PK	6 $\frac{1}{8}$	1 $\frac{1}{4}$	4 $\frac{1}{4}$	-	-	-	-	75 lbs.	2

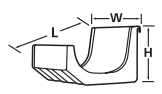

**ACCESSORIES**

**See Through Crystal Clear Lids**  
Keep contents dust-free and protected

**NEW! STYLE**

**Adhesive Labels & Card Stock Holders**  
Clearly identify bin contents. See Pg. 11

**Length Dividers**  
Keep items separated in bin. Now available for all sizes!

**Slope-It™ Bin Inserts**  
15° slope inserts for 30224, 30230 and 30240 AkroBins improve visibility and accessibility of supplies by keeping them close to the front of the bin. Transform your AkroBins in one easy step!

**NEW!**

**Width Dividers**  
Available for 30230

**Bin Retainer Clip**  
Model No. 40599  
Hold bins securely on louvered panels. Will work with any size AkroBin or ProHANGER. Perfect for service vans and maintenance workers, plumbers, electricians or other tradesmen who store and transport supplies and material

**ProHANGER**



**Model No. 30330RED**  
Can be placed side-by-side on walls, rail rack or panel systems to store extra-long parts or supplies

- Unique J-Hook design cradles various shapes and sizes of contents
- Available End Cap inserts (sold separately) keep items from sliding out
- Each ProHANGER is capable of supporting up to 75 lbs.

**RELATED PRODUCTS**  
Create the perfect storage system - mix and match your selection of AkroBins with compatible products





# Super-Size AkroBins®

INDUSTRY-LEADING LARGE-CAPACITY STACKING BINS



## FEATURES

- 1 Anti-slide stop prevents stacked bins from shifting forward
- 2 Easy to carry with large handle molded onto back of bin
- 3 Reinforced side ribs add strength and prevent spreading when stacked
- 4 Large label area on front of bin
- 5 Divider slots help create separate compartments

## PRODUCT HIGHLIGHTS

- **CAPACITY** – Large-capacity storage to improve organization and workflow
- **STACKABLE** – Heavy-duty bins securely stack atop each other, sit on shelving, carts or dollies
- **DURABLE** – Molded of industrial-grade polymers, Super-Size AkroBins are resistant to weak acids and alkalis. Water, rust and corrosion-proof
- **VARIETY** – Available in 12 sizes and 4 colors: Red, Blue, Yellow, Clear
- **GUARANTEED** – Super-Size AkroBins are guaranteed not to crack or break under normal load conditions as stated in our 1-year limited warranty



## COLORS

Red, Yellow, Blue, Clear



800.253.2467  
akro-mils.com

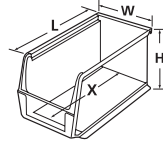

Super-Size AkroBins Model No.	Outside Dimensions (In.)			Inside Dimensions (In.)				Capacity/Quantity			Accessories						
	L	W	H	L	W	H	X	Max. Cap. per Bin	Stacking Cap./= Qty. Stacked	Ctn. Qty.	Width Dividers*	Length Dividers*	Divider Pkg. Qty. W L		Windows	Window Pkg. Qty.	Card Stock Holder
30280	20	12 <sup>3</sup> / <sub>8</sub>	6	16 <sup>7</sup> / <sub>8</sub>	10 <sup>1</sup> / <sub>8</sub>	5 <sup>3</sup> / <sub>8</sub>	15 <sup>1</sup> / <sub>2</sub>	200 lbs.	40 lb./10	4	-	40280 (3)	-	2	21280	2	29304
30281	20	12 <sup>3</sup> / <sub>8</sub>	8	16 <sup>7</sup> / <sub>8</sub>	10 <sup>1</sup> / <sub>8</sub>	7 <sup>3</sup> / <sub>8</sub>	15 <sup>1</sup> / <sub>2</sub>	200 lbs.	50 lb./7	3	-	40281 (3)	-	3	21281	3	29304
30282	20	12 <sup>3</sup> / <sub>8</sub>	12	16 <sup>7</sup> / <sub>8</sub>	10 <sup>1</sup> / <sub>8</sub>	11 <sup>3</sup> / <sub>8</sub>	15 <sup>1</sup> / <sub>2</sub>	200 lbs.	60 lb./5	2	-	40282 (3)	-	1	21282	2	29304
30283	20	18 <sup>3</sup> / <sub>8</sub>	12	16 <sup>7</sup> / <sub>8</sub>	16 <sup>3</sup> / <sub>8</sub>	11 <sup>3</sup> / <sub>8</sub>	15 <sup>1</sup> / <sub>2</sub>	300 lbs.	150 lb./5	1	-	40282 (3)	-	1	21283	1	29304
30284	23 <sup>3</sup> / <sub>8</sub>	8 <sup>1</sup> / <sub>4</sub>	7	20 <sup>3</sup> / <sub>8</sub>	6 <sup>3</sup> / <sub>8</sub>	6 <sup>1</sup> / <sub>8</sub>	19 <sup>3</sup> / <sub>8</sub>	200 lbs.	150 lb./5	4	41284 (2)	40286 (1)	2	4	21284	4	29304
30286	23 <sup>3</sup> / <sub>8</sub>	11	7	20 <sup>3</sup> / <sub>8</sub>	9 <sup>3</sup> / <sub>8</sub>	6 <sup>1</sup> / <sub>8</sub>	19 <sup>3</sup> / <sub>8</sub>	200 lbs.	150 lb./5	4	41286 (2)	40286 (3)	2	4	21286	4	29304
30287	23 <sup>3</sup> / <sub>8</sub>	11	10	20 <sup>3</sup> / <sub>8</sub>	9	9 <sup>1</sup> / <sub>8</sub>	19 <sup>3</sup> / <sub>8</sub>	300 lbs.	150 lb./5	4	41287 (2)	40287 (3)	6	6	21287	4	29304
30288	23 <sup>3</sup> / <sub>8</sub>	16 <sup>1</sup> / <sub>2</sub>	11	20 <sup>3</sup> / <sub>8</sub>	14 <sup>3</sup> / <sub>8</sub>	10 <sup>1</sup> / <sub>8</sub>	19 <sup>3</sup> / <sub>8</sub>	300 lbs.	150 lb./5	1	41288 (2)	40287 (3)	6	6	21288	1	29304
30289	23 <sup>3</sup> / <sub>8</sub>	18 <sup>3</sup> / <sub>8</sub>	12	20 <sup>3</sup> / <sub>8</sub>	16	11 <sup>3</sup> / <sub>8</sub>	19 <sup>3</sup> / <sub>8</sub>	300 lbs.	150 lb./5	1	41289 (2)	40289 (3)	2	1	21289	1	29304
30290	29 <sup>1</sup> / <sub>4</sub>	18 <sup>3</sup> / <sub>8</sub>	12	26 <sup>3</sup> / <sub>8</sub>	16 <sup>3</sup> / <sub>8</sub>	11 <sup>3</sup> / <sub>8</sub>	24 <sup>3</sup> / <sub>8</sub>	300 lbs.	150 lb./5	1	-	40290 (3)	-	1	21283	1	29304
30292	29 <sup>1</sup> / <sub>4</sub>	11	10	26 <sup>3</sup> / <sub>8</sub>	9	9 <sup>1</sup> / <sub>8</sub>	25 <sup>3</sup> / <sub>8</sub>	300 lbs.	150 lb./5	4	41287 (2)	40292 (3)	6	6	21287	4	29304
30293	29 <sup>1</sup> / <sub>4</sub>	16 <sup>1</sup> / <sub>2</sub>	11	26 <sup>3</sup> / <sub>8</sub>	14 <sup>3</sup> / <sub>8</sub>	10 <sup>1</sup> / <sub>8</sub>	25 <sup>3</sup> / <sub>8</sub>	300 lbs.	150 lb./5	1	41288 (2)	40292 (3)	6	6	21288	1	29304

One color per carton: Specify Red, Blue, Yellow or Clear. Not recommended to hang on rack or panel systems. Order in carton quantities. \* ( ) = Max. # of divider slots per bin.

## ACCESSORIES



**Window Insert**  
Optimizes interior space and keeps contents visible



**Width Dividers**  
Available for 7 bin models



**Length Dividers**  
Available for all sizes



**Adhesive Labels & Card Stock Holders**  
Card Stock Holders fit in bins' existing slot; adhesive labels also available. See Pg. 11

## SUPER-SIZE AKROBIN® CARTS



Easy organization of bulky parts in 4, 6, 9, 12 and 16-bin configurations

- Carts hold a variety of Super-Size AkroBins (sold separately)
- Heavy-duty frames with capacity from 900 to 1,500 lbs. (See Pg. 61)

**RELATED PRODUCTS**  
Increase the benefits of your Super-Size AkroBins with the following products



46-48 Wire Shelving Systems



49-51 Steel Shelving Systems



61 Super-Size Bin Carts



67 Dollies



# Specialty AkroBins®

EARTHSAVER AKROBINS: 1800 SERIES AKROBINS : ESD CONTAINERS

## EarthSaver® Series: AkroBins®

AKROBINS MADE OF RECYCLED MATERIAL



MADE IN THE USA

- **RECYCLED** – EarthSaver AkroBins made of 100% recycled material. Make a positive impact on the environment!
- **GUARANTEED** – EarthSaver AkroBins are guaranteed not to crack or break under normal load conditions as stated in our 1-year limited warranty
- **VARIETY** – Available in 7 sizes and 3 colors: Hunter Green, Sandstone and Terra Cotta
- **ACCESSORIES** – Crystal Clear Lids, Length Dividers and Width Dividers available (see Pg. 5)

### COLORS

Hunter Green, Sandstone, Terra Cotta

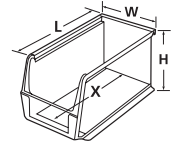

EarthSaver AkroBins Model No.	Outside Dimensions (In.)			Inside Dimensions (In.)				Capacity/Quantity	
	L	W	H	L	W	H	X	Bin Load Capacity On Rack	Bin Ctn. Qty.
30210RECY	5%	4%	3	4%	3 <sup>3</sup> / <sub>16</sub>	2 <sup>3</sup> / <sub>16</sub>	4	10 lbs.	24
30220RECY	7%	4%	3	6%	3 <sup>3</sup> / <sub>16</sub>	2 <sup>3</sup> / <sub>16</sub>	6	10 lbs.	24
30230RECY	10%	5 <sup>1</sup> / <sub>2</sub>	5	10%	4%	4%	9	30 lbs.	12
30234RECY	14%	5 <sup>1</sup> / <sub>2</sub>	5	14%	4%	4%	12 <sup>3</sup> / <sub>16</sub>	50 lbs.	12
30239RECY	10%	8%	7	10	6%	6%	8	50 lbs.	6
30240RECY	14%	8%	7	14	6%	6%	12	60 lbs.	12
30250RECY	14%	16 <sup>1</sup> / <sub>2</sub>	7	14	14%	6%	12	75 lbs.	6

One color per carton: SS = Sandstone, TC = Terra Cotta and HG = Hunter Green. Order in carton quantities. CAUTION: When using bins with hanging systems, do not exceed the weight capacity for the rack, which may be less than the total sum of bin capacities.

## 1800 Series AkroBins®

STACKABLE SHELF BINS



MADE IN THE USA

### COLOR

Beige

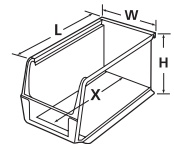

1800 Series Model No.	Outside Dimensions (In.)			Inside Dimensions (In.)				Ctn. Qty.	Dividers	Pkg. Qty.	Capacity (Lbs.)
	L	W	H	L	W	H	X				
30348BEIGE	20 <sup>1</sup> / <sub>2</sub>	8%	7	20	7%	6 <sup>1</sup> / <sub>2</sub>	20	6	40348 (3)	6	60
30358BEIGE	20 <sup>1</sup> / <sub>2</sub>	11	7	20	10%	6 <sup>1</sup> / <sub>2</sub>	20	6	40358 (3)	6	75

Available in Beige. Order in carton quantities.

- **DURABLE** – Strong industrial-grade polymer construction
- **STACKING** – Stackable storage systems for large, heavy or bulky items
- **DIVIDABLE** – One black width divider included per bin

## ESD Containers

AKROBINS MADE WITH ELECTROSTATIC DISSIPATIVE MATERIALS



MADE IN THE USA

- **PROTECTION** – Dissipate electrostatic charges, which can severely damage sensitive electronic components
- **OHM RATING** – Static Dissipative Range 106 to 109 ohms/sq.
- **LOW CARBON** – 1% - 2% carbon content

### COLOR

Black

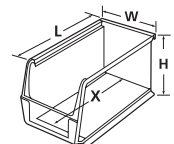

ESD Containers Model No.	Inside Dimensions (In.)			Outside Dimensions (In.)				Cap. on Rack	Ctn. Qty.
	L	W	H	L	W	H	X		
30210ESD	5%	4%	3	4%	3 <sup>3</sup> / <sub>16</sub>	2 <sup>3</sup> / <sub>16</sub>	4	10 lbs.	24
30220ESD	7%	4%	3	6%	3 <sup>3</sup> / <sub>16</sub>	2 <sup>3</sup> / <sub>16</sub>	6	10 lbs.	24
30230ESD	10%	5 <sup>1</sup> / <sub>2</sub>	5	10%	4%	4%	9	30 lbs.	12
30235ESD	10%	11	5	10%	10	4%	9	50 lbs.	6
30240ESD	14%	8%	7	14	6%	6%	12	60 lbs.	12

Available in Black. Order in carton quantities.



# InSight®

## ULTRA-CLEAR POLYCARBONATE BINS

800.253.2467  
akro-mils.com



STORAGE BINS –  
HANGING & STACKING

### FEATURES

- 1 Unique "lock-in-place" design for secure stacking
- 2 Strong molded hanger supports bins on hanging systems
- 3 Large label area for part identification and bar code scanning
- 4 Optional lids (sold separately) protect contents from dust. Will stack with lids in place!
- 5 Clear length and width dividers available (sold separately)

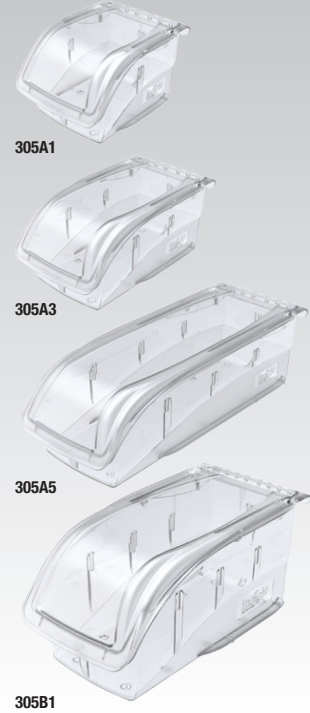

**COLOR**  
Clear



### PRODUCT HIGHLIGHTS

- **VISIBILITY** – Bins provide easy and maximum visibility of parts and supplies
- **FUNCTIONAL** – Bins securely stack, and hang from louvered panels, rails and the ReadySpace® Storage System
- **NO-TIP FEATURE** – Patent-pending design: Bins won't tip when stacked!
- **DURABLE** – Products made of high-impact polycarbonate are autoclavable up to 350° F
- **VARIETY** – Available in 4 sizes

*insight*  
by Akro-Mils

InSight Model No.	Outside Dimensions (In.)			Inside Dimensions (In.)			Capacity/Quantity		Accessories					
	L	W	H	L	W	H	Capacity (lbs.)	Bin Ctn. Qty.	Width Divider	Divider Pkg Qty.	Length Divider	Divider Pkg Qty.	Lid	Lid Pkg Qty.
305A1	5 $\frac{3}{8}$	4 $\frac{1}{8}$	3 $\frac{1}{4}$	4 $\frac{1}{4}$	3 $\frac{3}{8}$	2 $\frac{5}{8}$	10	16	415A1 (1)	8	405A1 (1)	8	305A2	16
305A3	7 $\frac{7}{8}$	4 $\frac{1}{8}$	3 $\frac{1}{4}$	6 $\frac{1}{4}$	3 $\frac{3}{8}$	2 $\frac{5}{8}$	10	16	415A1 (2)	8	405A3 (1)	8	305A4	16
305A5	10 $\frac{7}{8}$	4 $\frac{1}{8}$	3 $\frac{1}{4}$	9 $\frac{1}{4}$	3 $\frac{3}{8}$	2 $\frac{5}{8}$	15	12	415A1 (3)	8	405A5 (1)	6	305A6	12
305B1	10 $\frac{7}{8}$	5 $\frac{1}{2}$	5 $\frac{1}{4}$	9 $\frac{9}{16}$	4 $\frac{1}{8}$	4 $\frac{7}{16}$	25	12	415B1 (3)	6	405B1 (1)	6	305B2	12

# in ( ) represents divider slots per bin.

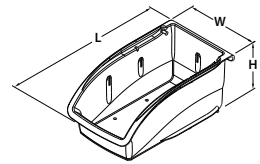

### ACCESSORIES



**Lids**  
Protect bin contents from dust



**Dividers**  
Expand sorting options with length dividers

### RELATED PRODUCTS

Create the perfect storage solution — mix and match your InSight Bins with these products



**28-30** Louvered Hanging Systems



**31** ReadySpace Storage Systems



**32** Rail Hanging Systems



# Stak-N-Store Bins

STACKABLE BINS PERFECT FOR HEAVY, BULKY ITEMS



## COLORS

Red, Blue, White, Clear, Gray



## FEATURES

- 1 Large radius corners and rolled rim add strength
- 2 Side ribs add stability when stacked
- 3 Wide hopper front allows easy access to bulky items
- 4 Large comfort grip handles

## PRODUCT HIGHLIGHTS

- **STACKBLE** – Bins stack to form tall, stable storage arrangements on floors or standard industrial shelving
- **CAPACITY** – 75-lb. weight capacity
- **DURABLE** – Durable, industrial-grade polymer will not rust, corrode or bend out of shape even when fully loaded
- **COST-EFFECTIVE** – Longer service life resulting in lower replacement costs
- **VARIETY** – Available in 3 sizes and 5 colors: Red, Blue, Gray, White, Clear

Stak-N-Store Bins Model No.	Outside Dimensions (In.)			Inside Dimensions (In.)				Capacity/Quantity				
	L	W	H	L	W	H	X	Cu. Ft.	Gal	Lbs.	Stacking Height	Ctn. Qty.
13014	17½	10¾	12½	15¾	8	12¼	13½	.98	7.4	75	3	4
13017*	15¼	19¾	12¾	13¾	17½	12¼	11½	1.7	12.7	75	3	3
13018	17½	16½	12½	15¾	13¾	12¼	13½	1.6	12	75	3	2

One color per carton. Specify Red, Blue, Gray or Clear. \*13017 also available in White. Order in carton quantities.

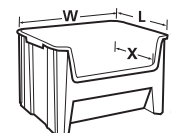

## RELATED PRODUCTS

Add mobility to your Stak-N-Store Bins with



46-48 Wire Shelving Systems



49-51 Steel Shelving Systems



67 Dollies

# Adhesive Labels & Card Holders

2 NEW LABELING OPTIONS FOR AKRO-MILS  
BINS, TOTES, CONTAINERS

800.253.2467  
akro-mils.com



## PRODUCT HIGHLIGHTS

- **FUNCTIONAL** – Can be used on a variety of Akro-Mils bins, totes and containers
- **EFFICIENT** – Perfect for 5S Lean and other productivity initiatives
- **VARIETY** – Card Stock Holders, Adhesive Labels, Adhesive Backed Card Holders available

### Card Stock Holders

- Clear Plastic Card Holder models 29300, 29301, 29302 and 29303 fit in bin's existing card holder slot
- 29304 Card Stock Holder has adhesive back to work with bins and containers without card slots
- Card stock labels identify contents of bin

### Adhesive Labels

- Designed to fit inside card slot areas on Akro-Mils AkroBins®, ShelfMax® Bins and Shelf Bins
- Acrylic adhesive backing forms permanent bond with bins
- Can be used on a wide range of Akro-Mils bins, totes and containers, including AkroDrawers®, Super-Size AkroBins® and Stak-N-Store

### Adhesive Backed Card Holder

- Model 29304 features an adhesive back to work with bins that do not have card holder slots, such as Super-Size AkroBins, 33" Wide AkroBins, Akro-Tubs, NST's, ALC's, SWC's and Stak-N-Store Bins
- 2<sup>3</sup>/<sub>8</sub>" x 3<sup>7</sup>/<sub>8</sub>" surface area required

Adhesive Labels	Dimensions (In.)		Works With:	Labels Per Sheet	Pkg. Qty.	Total Labels
Model No.	W	H				
29200	1 <sup>5</sup> / <sub>8</sub>	3 <sup>4</sup> / <sub>8</sub>	30110*	36	10 Sheets	360
29201	2 <sup>5</sup> / <sub>8</sub>	3 <sup>4</sup> / <sub>8</sub>	30120, 30130, 30150, 30170, 30128, 30138, 30158, 30178, 30124, 30164, 30184, 30174*	24	10 Sheets	240
29202	2 <sup>5</sup> / <sub>8</sub>	7 <sup>1</sup> / <sub>8</sub>	30210, 30220, 30224, All ShelfMax Bins*	20	10 Sheets	200
29203	3 <sup>3</sup> / <sub>8</sub>	1 <sup>1</sup> / <sub>8</sub>	30230, 30234, 30235, 30239, 30240, 30250, 30255, 30260, 30265, 30270*	12	10 Sheets	120

The labels were designed to fit inside our card slot area and have an acrylic adhesive backing. The approximate time for permanent bond is 48 - 72 hours. \*Works with multiple sizes of Super-Size AkroBins, Attached Lid Containers, Nest & Stack Totes, Straight Wall Containers, AkroDrawers or Stak-N-Store Bins.

Card Stock Holder	Dimensions (In.)		Works With:	Cards Per Sheet	Sheets Per Pack	Total Cards Per Pack	Total # of Clear Holders
Model No.	W	H					
29300	3	1 <sup>3</sup> / <sub>8</sub>	All 4" Shelf Bins**	24	3	72	25
29301	3	1	30210, 30220, 30224, All ShelfMax Bins	20	3	60	25
29302	4	1 <sup>3</sup> / <sub>8</sub>	30230, 30234, 30235, 30239, 30240, 30250, 30255, 30348, 30358	12	3	36	25
29303	4	2	30260, 30265, 30270, 33223	12	3	36	25
29304*	3 <sup>1</sup> / <sub>2</sub>	2	All Super-Size Akro-Bins, and items without Card Slots - adhesive strip on back	10	3	30	25

The clear holders for the 29300 - 29303 fit in our card slot holder. \*The 29304 has an adhesive back and will work with multiple sizes of products that do not have a card slot holder such as Super-Size AkroBins, 33" Wide AkroBins, Attached Lid Containers, Nest & Stack Totes, Straight Wall Containers or Stak-N-Store Bins. \*\*Excluding 30110 (29300 can be cut to length) 11%.



30230 with 20203



30240 with 20303



30292 with 29304

## 10° EXTENDED LABEL HOLDER



### Model No. 40410

Designed for larger bar code scanning.  
Works with Shelf Bins & ShelfMax

10° Extended Label Holder	Outside Dimensions (In.)			Ctn. Qty.	
	Model No.	L	W		H
	40410	-	4	2 <sup>1</sup> / <sub>4</sub>	24

## RELATED PRODUCTS

Adhesive Labels and Card Holders work with



4-5 AkroBins



6-7 Super-Size AkroBins



12 Shelf Bins



13 ShelfMax





# Shelf Bins

INDUSTRY-LEADING 4" HIGH SHELF BINS ARE DURABLE, EFFICIENT

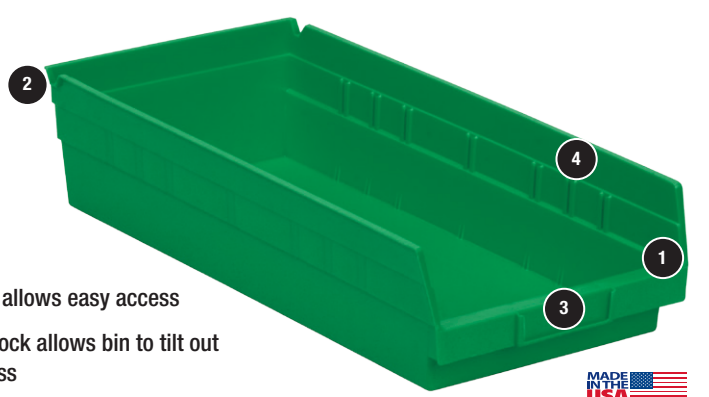

## FEATURES

- 1 Wide hopper front allows easy access
- 2 Built-in rear hanglock allows bin to tilt out for complete access
- 3 Molded-in label area identifies contents
- 4 Each bin accepts up to 7 dividers (except 30110)

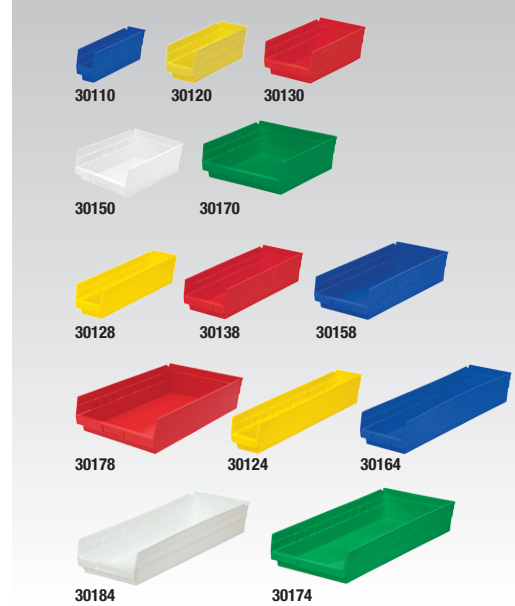

## COLORS

Red, Yellow, Blue, Green, White, Clear



Also available in recycled Hunter Green, Sandstone and Terra Cotta. See Pg. 14.

## PRODUCT HIGHLIGHTS

- **EFFICIENT** – Shelf Bins work with 12", 18" and 24" deep shelving, pick racks or vertical storage and retrieval units
- **DURABLE** – Industrial-grade polymer bins outlast corrugated bins — paying for themselves in reduced replacement costs. Bins won't spread or crack when loaded. One-piece construction is waterproof and resistant to grease or oil
- **NESTABLE** – Shelf Bins nest when empty to conserve space
- **VARIETY** – Available in 13 sizes and 6 colors: Red, Blue, Yellow, Green, White and Clear

Shelf Bins Model No.	Outside Dimensions (In.)			Inside Dimensions (In.)			Capacity/Quantity		Cups per Bin		Accessories			
	L	W	H	L	W	H	Bin Load Capacity	Ctn. Qty.	Small 30101	Large 30102	Width Dividers*	Divider Pkg. Qty.	Labels	Card Stock
30110	11%	2¾	4	10¼	1%	4	7 lbs.	24	3	–	–	–	29200	29300**
30120	11%	4%	4	10¼	3	4	10 lbs.	24	5	2	40120 (7)	24	29201	29300
30130	11%	6%	4	10¼	5½	4	15 lbs.	12	9	4	40130 (7)	24	29201	29300
30150	11%	8%	4	10¼	7%	4	15 lbs.	12	11	4	40150 (7)	24	29201	29300
30170	11%	11%	4	10¼	10	4	20 lbs.	12	15	6	40170 (7)	24	29201	29300
30128	17%	4%	4	16½	3	4	15 lbs.	12	8	3	40120 (7)	24	29201	29300
30138	17%	6%	4	16½	5½	4	20 lbs.	12	15	6	40130 (7)	24	29201	29300
30158	17%	8%	4	16½	7%	4	20 lbs.	12	15	6	40150 (7)	24	29201	29300
30178	17%	11%	4	16½	10	4	20 lbs.	12	25	12	40170 (7)	24	29201	29300
30124	23%	4%	4	22%	3	4	20 lbs.	12	11	4	40120 (7)	24	29201	29300
30164	23%	6%	4	22%	5½	4	20 lbs.	6	21	8	40130 (7)	24	29201	29300
30184	23%	8%	4	22%	7%	4	20 lbs.	6	25	8	40150 (7)	24	29201	29300
30174	23%	11%	4	22%	10	4	20 lbs.	6	35	16	40170 (7)	24	29201	29300

One color per carton: Specify Red, Blue, Yellow, Green, White or Clear. Order in carton quantities. \* ( ) = Max. # of dividers per bin. \*\*29300 must be cut to length to fit 30110.

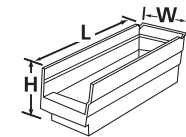

Bin Cups Model No.	Outside Dimensions (In.)			Ctn. Qty.
	L	W	H	
30101	2	3¼	3	48
30102	2¾	5	3	24

## ACCESSORIES



**Dividers**  
Create additional storage compartments (see chart)



**10° Extended Label Holder Model No. 40410**  
Not compatible with 30110. (See Pg. 11)



**Adhesive Labels & Card Stock Holders**  
Card stock holders fit in bins' existing slot; Adhesive labels also available



**Bin Cups**  
Lift out easily for parts retrieval (see chart)



# ShelfMax® Bins

6" HIGH SHELF BINS MAXIMIZE STORAGE CAPACITY

800.253.2467  
akro-mils.com



STORAGE BINS -  
SHELF STYLE

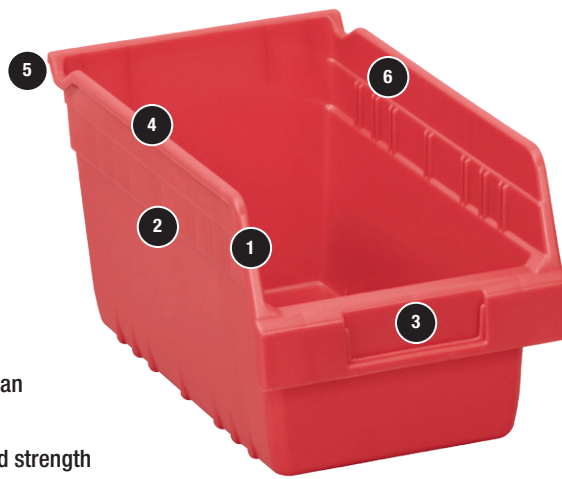

## FEATURES

- 1 Front opening is 3/4" higher than comparable 6" products
- 2 Reinforced side ribs for added strength
- 3 Large label area aids in part identification and bar code scanning
- 4 Rolled ridge provides added strength and durability when filled to capacity
- 5 Built-in rear hanglock allows bin to tilt out for complete access
- 6 Optional dividers create additional storage options

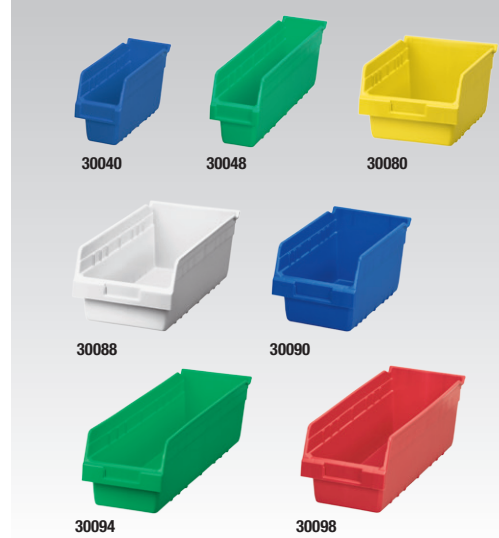

## COLORS

Red, Yellow, Blue, Green, White, Clear



## PRODUCT HIGHLIGHTS

- **CAPACITY** – Bins offer 85% more storage than traditional 4" bins
- **EFFICIENT** – Works with Akro-Mils steel shelving, wire shelving, pick racks and bench racks
- **DURABLE** – Superior construction compared to corrugated bins
- **VARIETY** – Available in 7 sizes and 6 colors: Red, Blue, Yellow, Green, White and Clear

ShelfMax Model No.	Outside Dimensions (In.)			Inside Dimensions (In.)			Storage Capacity			Accessories		
	L	W	H	L	W	H	Cubic Inches	Bin Load Capacity	Ctn. Qty.	Width Dividers*	Divider Pkg. Qty.	Card Stock
30040	11%	4%	6	9 3/4	2 1/2	5 1/8	175	20 lbs.	16	40020 (7)	12	29301
30048	17%	4%	6	16	2 1/2	5 1/8	280	25 lbs.	8	40020 (7)	12	29301
30080	11%	8%	6	9 3/4	6%	5 1/8	398	35 lbs.	8	40040 (7)	12	29301
30088	17%	8%	6	16	6%	5 1/8	648	35 lbs.	8	40040 (7)	12	29301
30090	11%	6%	6	9 3/4	5	5 1/8	310	30 lbs.	10	40030 (7)	12	29301
30094	23%	6%	6	21 3/4	5	5 1/8	686	35 lbs.	10	40030 (7)	12	29301
30098	17%	6%	6	16	5	5 1/8	505	35 lbs.	10	40030 (7)	12	29301

One color per carton; Specify Red, Blue, Yellow, Green, White or Clear. Order in carton quantities. \* ( ) = Max. # of dividers per bin.

## ACCESSORIES



**Dividers**  
Create additional storage compartments



**Adhesive Labels & Card Stock Holders**  
Card stock holders fit in bins' existing slot; Adhesive labels also available. (See Pg. 11)



**10° Extended Label Holder Model No. 40410**  
Designed for larger bar code scanning. (See Pg. 11)

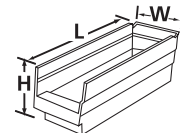

## RELATED PRODUCTS

Create the perfect storage solution — mix and match your ShelfMax Bins with these products



33-35 Pick Rack Systems



46-48 Wire Shelving Systems



49-51 Steel Shelving Systems

# Specialty Shelf Bins

EARTHSAVER SHELF BINS : VANTAGEBINS : ECONOMY BINS

## EarthSaver® Series: Shelf Bins

SHELF BINS MADE OF RECYCLED MATERIAL

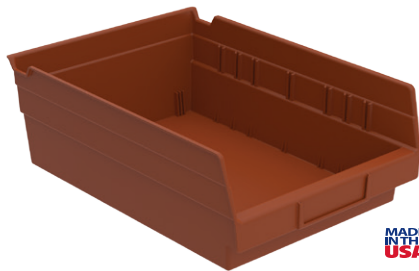

- **RECYCLED** – EarthSaver Shelf Bins made of 100% recycled material. Make a positive impact on the environment!
- **VERSATILE** – Optional dividers keep items neatly separated
- **VARIETY** – Available in 8 sizes and 3 colors: Hunter Green, Sandstone and Terra Cotta
- **ACCESSORIES** – Width Dividers and Extended Label Holders available. (See Pg. 12)

### COLORS

Hunter Green, Sandstone, Terra Cotta

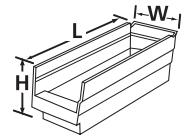

EarthSaver Shelf Bins Model No.	Outside Dimensions (In.)			Inside Dimensions (In.)			Cups per Bin		
	L	W	H	L	W	H	Ctn. Qty.	Small 30101	Large 30102
30110RECY	11½	2¾	4	10¼	1¾	4	24	3	–
30120RECY	11½	4½	4	10¼	3	4	24	5	2
30130RECY	11½	6½	4	10¼	5½	4	12	9	4
30150RECY	11½	8½	4	10¼	7½	4	12	11	4
30128RECY	17½	4½	4	16½	3	4	12	8	3
30138RECY	17½	6½	4	16½	5½	4	12	15	6
30124RECY	23½	4½	4	22½	3	4	12	11	4
30164RECY	23½	6½	4	22½	5½	4	6	21	8

One color per carton: SS = Sandstone, TC = Terra Cotta and HG = Hunter Green. Order in carton quantities.

## VantageBins™

DIVIDABLE UP TO 10 SECTIONS



- **V-GROOVE** – Standard VantageBin has molded-in V-groove bottom to keep items upright and prevent them from sliding
- **NESTABLE** – Both models of VantageBin nest when empty to conserve storage space
- **DURABLE** – Industrial-grade polymer construction
- **VARIETY** – 30420 available in 3 colors: White, Gray, Yellow; 30400 available in 2 colors: White, Gray

### COLORS

White, Gray, Yellow

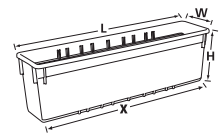

VantageBin		Outside Dimensions (In.)			Inside Dimensions (In.)			Ctn. Qty.	Dividers/Pk.	
Model No.	Description	L	W	H	L	W	H			X
30400YEL10PK	Standard Bin	16¾	7¼	5½	15½	6½	5½	15½	10	–
30400WHI10PK	Standard Bin	16¾	7¼	5½	15½	6½	5½	15½	10	–
30400GRY10PK	Standard Bin	16¾	7¼	5½	15½	6½	5½	15½	10	–
30420WHI6PK	Dividable Bin	24	5½	7	22½	3½	7	22¾	6	40420/12
30420GRY6PK	Dividable Bin	24	5½	7	22½	3½	7	22¾	6	40420/12

One color per carton: Specify color when ordering. Order in carton quantities. Weight capacity per bin is 40 lbs.

## Economy Bins

NESTING & STACKING SHELF BIN



- **VERSATILE** – Economy Bins make full use of shelf space on 12" or 18" deep shelving and stack to fill space between shelves
- **DURABLE** – Industrial-grade polymer construction
- **EXCLUSIVE** – The only small parts bin that can nest and stack
- **EFFICIENT** – Generous bin opening allows easy access to items

### COLOR

Black

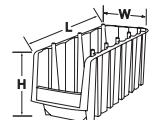

Economy Bins	Outside Dimensions (In.)			Inside Dimensions (In.)			Ctn. Qty.
Model No.	L	W	H	L	W	H	
30796BLACK	8½	6½	5	6¾	4	4¾	10
30716BLACK	11½	6½	5	9¾	4	4¾	10
30776BLACK	17½	6½	7	14¾	3¾	6¾	10
30718BLACK	11½	8½	5	9	5¾	4¾	8
30778BLACK	17½	8½	7	14¾	5½	6¾	8

Order in carton quantities.



# Indicator® Bin

## TWO-TONED INVENTORY CONTROL BIN

800.253.2467  
akro-mils.com



STORAGE BINS –  
SHELF STYLE

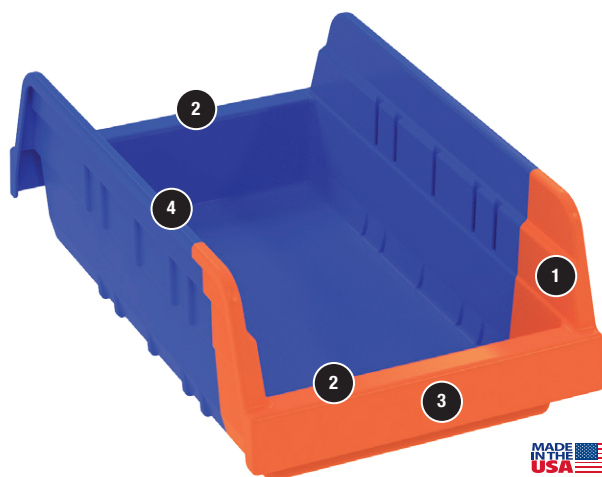

### FEATURES

- 1 Bright orange trigger color shows low stock levels
- 2 Innovative double-hopper bin can be filled or picked from both sides
- 3 Large label area on both sides of bin
- 4 Rolled ridge provides added strength and durability
- 5 Width dividers (sold separately) used to separate reserve stock

### PRODUCT HIGHLIGHTS

- **INVENTORY CONTROL** – Prevents stockouts with visual recognition when supplies need to be replenished
- **EASY TO USE:**
  - STOCK* – using the divider to designate volume for the inventory reserve
  - PICK* – from the blue side of the bin until you reach the divider
  - FLIP* – the bin to the orange reserve to show inventory levels are low
  - REPLENISH* – the bin and repeat!
- **VALUE** – Low-cost alternative to high-end inventory control systems
- **VARIETY** – Bins available in 4 sizes



36442

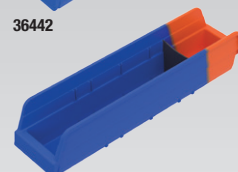

36448

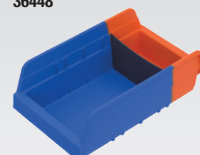

36462

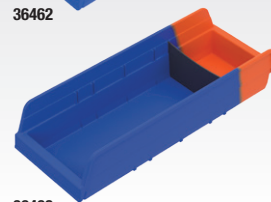

36468

**COLOR**  
Blue/Orange

**BINTELLIGENCE**  
SERIES  
by Akro-Mils



**Stock Pick Flip Replenish**

## Indicator®

Indicator Bins		Outside Dimensions (In.)			Inside Dimensions (In.)			Accessories		
Model No.	Description	L	W	H	L	W	H	Bin Ctn. Qty.	Dividers*	Divider Pkg. Qty.
36442BLUE	Indicator Bin (Blue/Orange)	11%	4¼	4	9%	2%	3%	24	40120	24
36448BLUE	Indicator Bin (Blue/Orange)	17%	4%	4	16%	2%	3%	12	40442	12
36462BLUE	Indicator Bin (Blue/Orange)	11%	6%	4	9%	5%	3%	12	40130	24
36468BLUE	Indicator Bin (Blue/Orange)	17%	6%	4	16%	5%	3%	12	40462	12

\*Dividers sold separately.

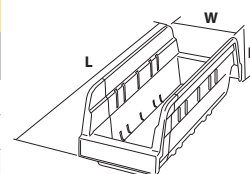

### RELATED PRODUCTS

Create the perfect storage solution – mix and match your Indicator Bins with these products



33-35 Pick Rack Systems



46-48 Wire Shelving Systems



49-51 Steel Shelving Systems





# System Bins™

## SINGLE-PIECE, 6-COMPARTMENT STORAGE UNIT

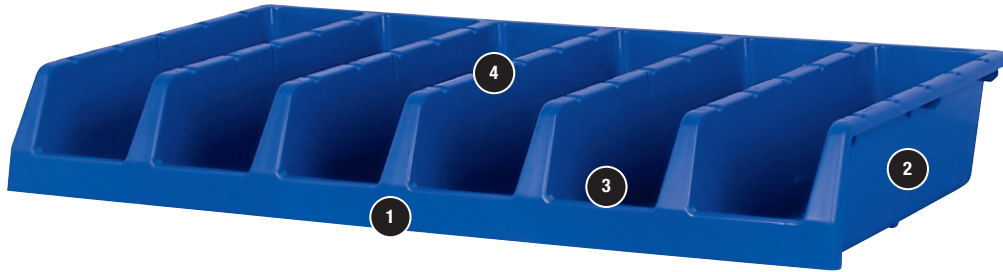

30312



30318

### COLORS

Red, Yellow, Blue



## FEATURES

- 1 Large label area for easy content identification
- 2 Smooth surfaces make the bin easy to fill and keep clean
- 3 Wide hopper front allows easy access for quick parts picking
- 4 Sturdy, double-wall construction for strength and durability

## PRODUCT HIGHLIGHTS

- **SINGLE-PIECE** – Configured six-across in a single unit, 33" wide by 5" high
- **VALUE** – A cost-effective alternative to flimsy, individual cardboard boxes
- **DURABLE** – Sturdy interior double-wall construction. One-piece, injection-molded
- **STACKABLE** – Can be safely stacked using a 3/8" wood dowel rod (not included)
- **NESTABLE** – Bins nest when empty to conserve space
- **VARIETY** – Available in 12" or 18" depths. Colors: Red, Yellow, Blue

## System Bins™

System Bins		Dimensions (In.)			Bin Compartment Dimensions (In.)**			Ctn. Qty.
Model No.	Description	L	W	H	L	W	H	
30312	12" System Bin	12	33	5	10%	3%	4 <sup>1</sup> / <sub>16</sub>	5
30318	18" System Bin	18	33	5	16%	3%	4 <sup>1</sup> / <sub>16</sub>	5
40312*	System Bin Divider (Black only)	5/2	4 <sup>7</sup> / <sub>16</sub>	4 <sup>7</sup> / <sub>16</sub>	–	–	–	6 pk.

One color per carton: Specify Red, Blue or Yellow. Order in carton quantities. \*One divider per compartment, six per unit. \*\*Bottom inside dimension per compartment.

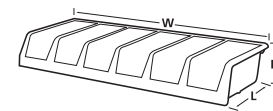

## ACCESSORIES

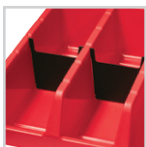

**System Bin Divider**  
Width dividers create additional storage options

## RELATED PRODUCTS

System Bins work with these products



33-35 Pick Rack Systems



33-35 Bench Pick Rack



46-48 Wire Shelving Systems



49-51 Steel Shelving Systems



60 Shelf Carts



# AkroDrawers®

## HEAVY-DUTY STORAGE DRAWERS

800.253.2467  
akro-mils.com



STORAGE BINS -  
SHELF STYLE

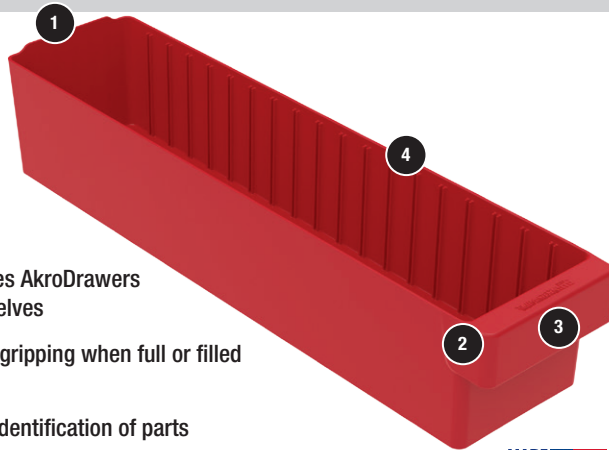

### FEATURES

- 1 Sturdy backstop tab ensures AkroDrawers can hang securely from shelves
- 2 Wide front handle for easy gripping when full or filled with heavy contents
- 3 Large label area for quick identification of parts
- 4 Multiple divider slots allow for customized storage solutions

### PRODUCT HIGHLIGHTS

- **PARTS PROTECTION** – AkroDrawers help keep your supplies, tools and parts secure and dust-free
- **FUNCTIONAL** – Drawers can be used with Akro-Mils' Super Modular Cabinets, Stackable Cabinets, Secure Mini-Cabinets, Louvered Carts, Pick Racks and Enclosed Steel Shelving
- **DURABLE** – Color drawers made of high-impact polystyrene; Crystal Clear drawers made of a durable acrylic blend
- **STACKABLE** – AkroDrawers can be stacked to optimize space
- **VARIETY** – Available in 9 sizes and 5 colors: Red, Yellow, Blue, Crystal Clear, Gray

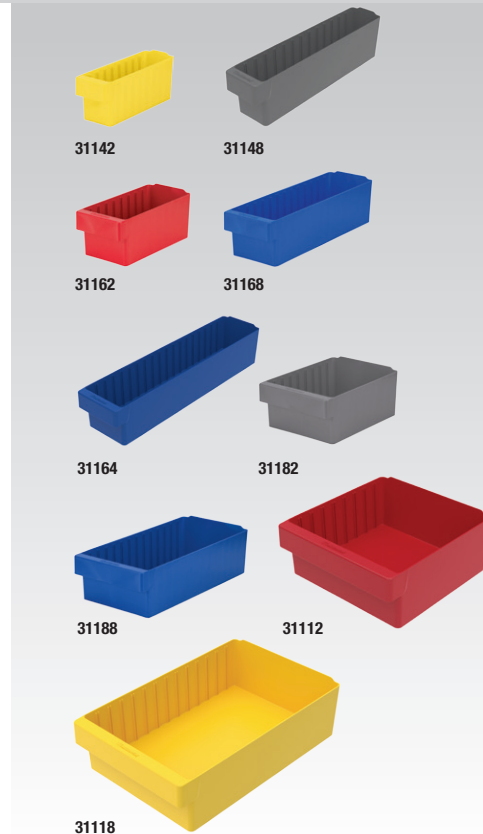

### AkroDrawers®

AkroDrawers Model No.	Outside Dimensions (In.)			Inside Dimensions (In.)			Capacity/Qty.		Dividers	Pkg. Qty
	L	W	H	L	W	H	Weight Capacity	Ctn. Qty.		
31142	11 $\frac{1}{2}$	3 $\frac{3}{4}$	4 $\frac{5}{8}$	10 $\frac{1}{4}$	3 $\frac{1}{2}$	4 $\frac{1}{8}$	15 lbs.	6	41440	6
31148	17 $\frac{1}{2}$	3 $\frac{3}{4}$	4 $\frac{5}{8}$	16 $\frac{1}{4}$	3 $\frac{1}{2}$	4 $\frac{1}{8}$	20 lbs.	6	41440	6
31162	11 $\frac{1}{2}$	5 $\frac{5}{8}$	4 $\frac{5}{8}$	10 $\frac{1}{4}$	4 $\frac{7}{8}$	4 $\frac{1}{8}$	20 lbs.	6	41460	6
31168	17 $\frac{1}{2}$	5 $\frac{5}{8}$	4 $\frac{5}{8}$	16 $\frac{1}{4}$	4 $\frac{7}{8}$	4 $\frac{1}{8}$	25 lbs.	6	41460	6
31164	23 $\frac{1}{2}$	5 $\frac{5}{8}$	4 $\frac{5}{8}$	22 $\frac{1}{2}$	4 $\frac{7}{8}$	4 $\frac{1}{8}$	25 lbs.	6	41460	6
31182	11 $\frac{1}{2}$	8 $\frac{1}{2}$	4 $\frac{5}{8}$	10 $\frac{1}{4}$	7 $\frac{1}{2}$	4 $\frac{1}{8}$	20 lbs.	4	41480	6
31188	17 $\frac{1}{2}$	8 $\frac{1}{2}$	4 $\frac{5}{8}$	16 $\frac{1}{4}$	7 $\frac{1}{2}$	4 $\frac{1}{8}$	25 lbs.	4	41480	6
31112	11 $\frac{1}{2}$	11 $\frac{1}{2}$	4 $\frac{5}{8}$	10 $\frac{1}{4}$	10 $\frac{1}{2}$	4 $\frac{1}{8}$	25 lbs.	4	41410	8
31118	17 $\frac{1}{2}$	11 $\frac{1}{2}$	4 $\frac{5}{8}$	16 $\frac{1}{4}$	10 $\frac{1}{2}$	4 $\frac{1}{8}$	25 lbs.	4	41410	8

Specify drawer color when ordering: Red, Blue, Yellow, Gray or Crystal Clear.

### COLORS

Red, Yellow, Blue, Crystal Clear, Gray



### ACCESSORIES

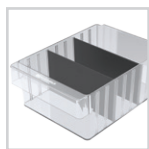

**Width Dividers**  
Available for all sizes!



**Adhesive Labels**  
Adhesive labels are ideal for content identification and form a permanent bond with bins. (See Pg. 11)

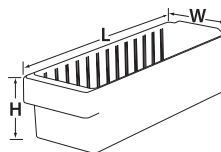

### RELATED PRODUCTS

Create the perfect storage solution — mix and match your AkroDrawers with these products



## **X-ON Electronics**

Largest Supplier of Electrical and Electronic Components

*Click to view similar products for [akro mills](#) manufacturer:*

Other Similar products are found below :

[41460](#) [10123](#) [10164](#) [35231RED](#) [06318](#) [10744](#) [19320](#) [10144](#) [09514](#) [10124](#) [10724](#) [30-239-GRN](#) [30230ESD](#) [05905](#) [30250BLUE](#) [40716](#) [30-239-BLU](#) [30235ESD](#) [30210RED](#) [30150BLUE](#) [05805](#)