

# FIBOX®

[www.fibox.com](http://www.fibox.com)

#### Production

Fibox Oy Ab  
Jorvaksenniitty, P.O. Box 16  
FIN-02421 JORVAS, Finland  
Tél. +358 9 2955 31 - Fax +358 9 2955 3200  
E-mail : [info@fibox.fi](mailto:info@fibox.fi), [sales@fibox.fi](mailto:sales@fibox.fi)

Fibox Ltd. Korea  
1381-2, Juan-Dong, Nam-Gu  
Incheon, Post No 402-853  
Republic of Korea  
Tél. +82 32 81 46 742 - Fax +82 32 81 46 077  
E-mail : [fibox@kornet.net](mailto:fibox@kornet.net)

#### Customer service

FIBOX Ltd.  
3 Primrose Hill Industrial Park  
Orde Wingate Way, Stockton on Tees  
Cleveland TS19 0BJ, England  
Tél. +44 1642 6044 00 - Fax +44 1642 6046 00  
E-mail : [sales@fibox.co.uk](mailto:sales@fibox.co.uk)

Fibox Oy Ab  
Jorvaksenniitty, P O Box 16  
FIN-02421 JORVAS, Finland  
Tél. +358 9 2955 351 - Fax +358 9 2955 3500  
E-mail : [info@fibox.fi](mailto:info@fibox.fi), [sales@fibox.fi](mailto:sales@fibox.fi)

Fibox Inc.  
810 Cromwell Park Drive  
Suite R, Glen Burnie  
MD 21061, USA  
Tél. +1 410 760 9696 - Fax +1 410 760 8686  
Call toll-free  
USA 1 888 342 6987 / 1888 FIBOX US  
E-mail : [sales@fiboxusa.com](mailto:sales@fiboxusa.com)

FIBOX FRANCE Sarl  
28 rue Paul Henri Spaak  
Parc de l'Esplanade  
F-77400 Saint Thibault Des Vignes  
Tél. +33-1-60 21 17 17 - Fax +33-1-60 21 17 18  
E-mail : [service.client@fibox.fr](mailto:service.client@fibox.fr)

FIBOX GmbH - FSC Germany  
Möllberger strasse 18  
D-32602 Vlotho, Germany  
Tél. +49 5733 87 160 - Fax +49 5733 87 1610  
E-mail : [info@fibox.de](mailto:info@fibox.de)

FIBOX GmbH - Switzerland  
Industrieareal Jenny  
CH-8866 Ziegelbrücke  
Tél. +41 55 617 2080 - Fax +41 55 617 2089  
E-mail : [info@fibox.ch](mailto:info@fibox.ch)

Fibox Ltd. Korea  
1381-2, Juan-Dong, Nam-Gu  
Incheon, Post No 402-853  
Republic of Korea  
Tél. +82 32 81 46 742 - Fax +82 32 81 46 077  
E-mail : [fibox@kornet.net](mailto:fibox@kornet.net)

Fibox Shanghai Ltd.  
2A, 2. etage, Block No. 55-56, 461 Hongcao Road  
Shanghai 200233, China  
Tél. +86 216 495 9922 - Fax +86 216 495 9667  
E-mail : [fibox@kornet.net](mailto:fibox@kornet.net)

FIBOX Sp. z.o.o.  
ul. Dzieciola 19  
04-988 Warsaw, Poland  
Tél. +48 22 872 9498 - Fax +48 22 872 9698  
E-mail : [info@fibox.pl](mailto:info@fibox.pl)

# FIBOX®

## ENCLOSURE CATALOGUE Version 3.5 GB



**WEB GUIDE**  
DESIGNERS HELP TOOL

# FIBOX

## C O N T E N T S

[www.fibox.com](http://www.fibox.com)

FIBOX COMPANY PRESENTATION.....	2
FIBOX IS ON THE WEB FOR YOU.....	3
QUALITY.....	4
CUSTOMISING.....	6



**FIBOX MNX**

### SMALL TO MEDIUM SIZE ENCLOSURES

**PC / ABS 52 x 50 x 40 mm – 300 x 230 x 110 mm**

**P / AL 50 x 45 x 31,5 mm – 600 x 310 x 180 mm**

FIBOX MNX PC / F / PCM / ABS.....	7-14
FIBOX PICCOLO PC / ABS.....	15-18
FIBOX EURONORD PC / ABS / ALUMINIUM / POLYESTER.....	19-28



**FIBOX EURONORD**

### MODULAR COMPONENT ENCLOSURES

**200 x 116 x 105 mm – 580 x 306 x 145 mm**

FIBOX MCE CONTROL / FEM / ISO.....	29-38
------------------------------------	-------



**FIBOX MCE**

### MEDIUM TO LARGE SIZE ENCLOSURES

**190 x 190 x 130 mm – 760 x 560 x 250 mm**

FIBOX SOLID PC / ABS / SM / HINGED COVER .....	39-44
FIBOX EK.....	45-54



**FIBOX SOLID**

FIBOX CAB PC/ABS hinged door with key lock.....	55-59
FIBOX CAB PC/ABS hinged door with latches.....	55-59
FIBOX QUICK with quick turn screw cover.....	60-61
FIBOX SPACE LINK with large flange openings.....	62-66



**FIBOX CAB**

### ENCLOSURES FOR ELECTRONICS AND INSTRUMENTATION

FIBOX CARDMASTER 3 PC / ABS.....	67-70
FIBOX EX for hazardous areas.....	71-76



**FIBOX CARDMASTER**

INSPECTION WINDOWS.....	77-80
-------------------------	-------

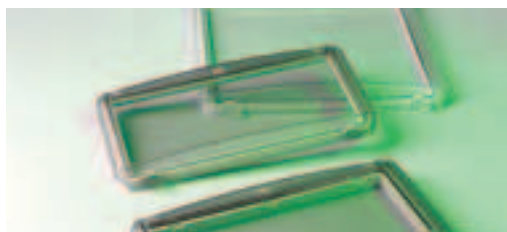

**FIBOX WINDOWS**



## FIBOX COMPANY PRESENTATION

Fibox enclosures are manufactured in modern factories located in the Helsinki, Finland metropolitan area and in Incheon, the Republic of Korea.

### 35 YEARS EXPERIENCE IN THERMOPLASTIC ENCLOSURES

In 1966, FIBOX introduced the first modular enclosures moulded from polycarbonate plastic. These enclosures began a new era in electrical panel building. From the beginning, a commitment to continuous product improvement and an on going product development has fuelled a dramatic and rapid growth for the company.

FIBOX, a privately-owned Finnish company, is one of the largest enclosure manufacturers in the world, and is the market leader in thermoplastic enclosures used for protecting electrical and electronic components operating in hostile environments.

Whatever your application, the FIBOX enclosure family features the widest range of high quality enclosures for the packaging and protection of electrical and electronic components and systems. Enclosures can be delivered in standard off the shelf configurations or customised to your exact specifications. Fibox Oy Ab earned the ISO 9001:2000 Quality Certification for all its operations in 1992.

Fibox voluntarily submits its products for third party testing and evaluation, and currently has many third party listings including, UL, CSA, KEMA, FIMKO, DNV, LR, etc. The company enclosures are rated EN 60529 even up to IP 68. In addition, nearly all products are rated for use in hazardous areas.

### CONTINUOUS PRODUCT DEVELOPMENT

The FIBOX enclosure range features over 500 different standard enclosures made of polycarbonate, ABS, polyester fibre-glass and aluminium. Fibox is the industry leader in developing both new products and new technologies for moulding thermoplastic enclosures. At Fibox, we consider moulding technology an essential part of product development.

For example, the new FIBOX MNX enclosure is the first to utilise direct injection of the enclosure gasket material during the body moulding process. This new process ensures precision moulding of the gasket guaranteeing superior enclosure protection ratings. Fibox is the only manufacturer applying this technology to enclosures.

Another example is FIBOX's emphasis on multiple slide technology for mould construction. While much more costly, this type of mould provides our OEM customers cost effective alternatives for modifying standard enclosures to meet their specific needs.

But more important than technical leadership, is the FIBOX commitment to understanding the needs of its customers. All our products are designed in close cooperation with our customers. We use input from our global customer base to produce new enclosure ranges, useful accessories and on-going product improvements and enhancements.

### MORE INFORMATION

e-mail: [info@fibox.fi](mailto:info@fibox.fi)

[www.fibox.com](http://www.fibox.com)

FIBOX's policy is to continually improve its products. Specifications in this Enclosure Catalogue are subject to change without notice.

Copyright 2005, Fibox Oy Ab

**Production:**  
Fibox Oy Ab  
Jorvaksenniitty, P.O. Box 16  
FIN-02421 JORVAS, Finland  
Tél. +358 9 2955 31 - Fax +358 9 2955 3200  
E-mail : [info@fibox.fi](mailto:info@fibox.fi), [sales@fibox.fi](mailto:sales@fibox.fi)

Fibox Ltd. Korea  
1381-2, Juan-Dong, Nam-Gu  
Incheon, Post No 402-853  
Republic of Korea  
Tél. +82 32 81 46 742 - Fax +82 32 81 46 077  
E-mail : [fibox@kornet.net](mailto:fibox@kornet.net)

**Customer service:**  
FIBOX Ltd.  
3 Primrose Hill Industrial Park  
Orde Wingate Way, Stockton on Tees  
Cleveland TS19 0BJ, England  
Tél. +44 1642 6044 00 - Fax +44 1642 6046 00  
E-mail : [sales@fibox.co.uk](mailto:sales@fibox.co.uk)

FIBOX AB  
Enhagsstiangan 3  
S-187 40 TABY, Sweden  
Tél. +46 8 792 26 70 - Fax +46 8 792 01 64  
E-mail : [info@fibox.se](mailto:info@fibox.se)

Fibox Oy Ab  
Jorvaksenniitty, P O Box 16  
FIN-02421 JORVAS, Finland  
Tél. +358 9 2955 351 - Fax +358 9 2955 3500  
E-mail : [info@fibox.fi](mailto:info@fibox.fi), [sales@fibox.fi](mailto:sales@fibox.fi)

Fibox Inc.  
810 Cromwell Park Drive  
Suite R, Glen Burnie  
MD 21061, USA  
Tél. +1 410 760 9696 - Fax +1 410 760 8686  
Call toll-free  
USA 1 888 342 6987 / 1888 FIBOX US  
E-mail : [sales@fiboxusa.com](mailto:sales@fiboxusa.com)

FIBOX A/S  
Kuldysen 13  
DK-2630 Tåstrup, Danmark  
Tél. +45 437 18055  
Fax +45 437 18035  
E-mail : [fibox@fibox.dk](mailto:fibox@fibox.dk)

FIBOX FRANCE Sarl  
28 rue Paul Henri Spaak  
Parc de l'Esplanade  
F-77400 Saint Thibault Des Vignes  
Tél. +33-1-60 21 17 17 - Fax +33-1-60 21 17 18  
E-mail : [service.client@fibox.fr](mailto:service.client@fibox.fr)

FIBOX GmbH - FSC Germany  
Möllberger strasse 18  
D-32602 Vlotho, Germany  
Tél. +49 5733 87 160 - Fax +49 5733 87 1610  
E-mail : [info@fibox.de](mailto:info@fibox.de)

FIBOX GmbH - Switzerland  
Industriereal Jenny  
CH-8866 Ziegelbrücke  
Tél. +41 55 617 2080 - Fax +41 55 617 2089  
E-mail : [info@fibox.ch](mailto:info@fibox.ch)

Fibox Ltd. Korea  
1381-2, Juan-Dong, Nam-Gu  
Incheon, Post No 402-853  
Republic of Korea  
Tél. +82 32 81 46 742 - Fax +82 32 81 46 077  
E-mail : [fibox@kornet.net](mailto:fibox@kornet.net)

Fibox Shanghai Ltd.  
2A, 2. etage, Block No. 55-56, 461 Hongcao Road  
Shanghai 200233, China  
Tél. +86 216 495 9922 - Fax +86 216 495 9667  
E-mail : [fibox@kornet.net](mailto:fibox@kornet.net)

FIBOX Sp. z o.o.  
ul. Dzieciola 19  
04-988 Warsaw, Poland  
Tél. +48 22 872 9498 - Fax +48 22 872 9698  
E-mail : [info@fibox.pl](mailto:info@fibox.pl)

## FIBOX is on the WEB for YOU

Find Fibox support services on the world wide web.

Visit our multi-language WEB site. As a global, multinational company, our home page is available in English, French, German, Swedish, Korean and Finnish.

### No time for drawing enclosures?

At [www.fibox.com](http://www.fibox.com), Fibox lends a helping hand to designers with CAD format drawings which can be easily downloaded. Select only the drawings you need for your selected enclosure and complete your design quickly. Save time with drawings available in both inches and millimetres.

### Need technical specifications, accessories or agency approvals?

At [www.fibox.com](http://www.fibox.com), you can obtain the technical information you need to complete your design. Select your enclosure, and print a PDF file with a photo, dimensional drawing (in metric and inches ), part numbers, ordering codes, technical data and regulatory agency approvals. There is even a list of correct accessories, ready for you to print. Select only the information you want and need!

### The world changes and so do we.

At [www.fibox.com](http://www.fibox.com), you can see the latest Fibox products and services. As a leader in injection moulding for the electrical and electronics industries, there is always something new at Fibox. Visit our WEB site to keep abreast of new products and services, the latest in customising options, or our growing list of accessories. Our electronic newsletter will introduce you to new products, new applications and new services, plus add a personal touch as you get to know Fibox around the world.

### Need technical or promotional material?

At [www.fibox.com](http://www.fibox.com), you can request our catalogue, full colour data sheets, press releases, manufacturers declarations, CD-ROM and much more. Just click the envelope and specify what you need.

Your thoughts, please!

Give us feedback. Tell us what you like and what you don't like! Contact us via [www.fibox.com](http://www.fibox.com), or E-mail us at [info@fibox.fi](mailto:info@fibox.fi). We are committed to continually improving our service to you. Please help us by sharing your opinions with us.

***YOU surf to US and let US serve YOU***



**FIBOX®**

**FIBOX  
MNX**

**FIBOX  
PICCOLO**

**FIBOX  
EURONORD**

**FIBOX  
MCE CONTROL**

**FIBOX  
MCE FEM**

**FIBOX  
MCE ISO**

**FIBOX  
SOLID**

**FIBOX  
EK**

**FIBOX  
CAB**

**FIBOX  
QUICK**

**FIBOX  
SPACE LINK**

**FIBOX  
CARDMASTER**

**FIBOX  
EX**

**FIBOX  
WINDOWS**

## FIBOX QUALITY CREATES CUSTOMER ADVANTAGE

Fibox has developed a sophisticated quality system to assure our customers of the reliability and consistency of our products and our service. All aspects of our operations, from design and development through to production and product delivery, are documented to ensure superior performance. Performance you can rely on.

Fibox is an ISO 9001 certified manufacturer and was awarded its certificate by Bureau Veritas Quality International in 1992. This approval covers specifications defined by ISO 9001:2000.



## THE FIBOX QUALITY POLICY

The Fibox approach to quality is documented in the Fibox Quality Policy manual.

## THE FIBOX QUALITY SYSTEM

The Fibox quality system applies not only to product quality and safety, but availability of product, accuracy of shipments, technical support and customer service. The continued success of this program is assured by regular internal and independent external audits.



## NEMA/UL CLASSIFICATIONS OF PROTECTION

The National Electrical Manufacturers Association (NEMA) is a US Manufacturers Organisation which actively promotes standardised product specifications for electrical apparatus.

NEMA performance criteria and test methods are used by Underwriters' Laboratories as guidelines for investigation and listing of electrical enclosures.

Approximate IP equivalents in parentheses



















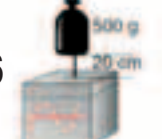



NEMA	1:	Indoor use primarily to provide a degree of protection against contact with the enclosed equipment and against a limited amount of falling dirt. (IP30)
	2:	Indoor use to provide a degree of protection against limited amounts of falling water and dirt. (IP31)
	3:	Outdoor use to provide a degree of protection against windblown dust, rain, and sleet; undamaged by the formation of ice on the enclosure. (IP64)
	3R:	Outdoor use to provide a degree of protection against falling rain and sleet; undamaged by the formation of ice on the enclosure. (IP32)
	3S:	Outdoor use to provide a degree of protection against windblown dust, rain and sleet; external mechanisms remain operable while ice laden.
	4:	Indoor or outdoor use to provide a degree of protection against splashing water, windblown dust and rain, hose directed water; undamaged by the formation of ice on the enclosure. (IP66)
	4X:	Indoor or outdoor use to provide a degree of protection against splashing water, windblown dust and rain, hose directed water; undamaged by the formation of ice on the enclosure, resists corrosion. (IP66)
	6:	Indoor or outdoor use to provide a degree of protection against the entry of water during temporary submersion at a limited depth; undamaged by the formation of ice on the enclosure.
	6P:	Indoor and outdoor use to provide a degree of protection against the entry of water during prolonged submersion at a limited depth.
	11:	Indoor use to provide by oil immersion a degree of protection of the enclosed equipment against the corrosive effects of corrosive liquids and gases.
	12,12K:	Indoor use to provide a degree of protection against dust, falling dirt and dripping noncorrosive liquids. (IP65)
	13:	Indoor use to provide a degree of protection against dust and spraying of water, oil and noncorrosive coolants. (IP65)



**THE IP AND IK CLASSIFICATIONS**

Ingress protection class of enclosures is given in the form of IP classification, a two digit coding which is shown below. Fibox has tested the enclosures according to IEC 529 or the newer EN 60529 4:1992. The latter requires the second digit to be tested from class 6 upwards separately to each level of class, thus the double marking IP 66 / IP 67 indicates that the actual tests have been made for both levels.

The European standard for empty enclosures, EN 50298:98 includes the IK impact test. This test is described in EN 50102, and as Fibox enclosures are tested to EN 50298:98, the data for impact resistance are available as well.

FIRST NUMBER Protection against solid objects		SECOND NUMBER Protection against liquids		IK CODE Protection against mechanical impacts	
<b>IP</b>	<b>TEST</b>	<b>IP</b>	<b>TEST</b>	<b>IK</b>	<b>TEST</b>
<b>0</b>	 no protection	<b>0</b>	 no protection	<b>00</b>	 no protection
<b>1</b>	 protected against solid objects up to 50 mm e.g. accidental touch by hands.	<b>1</b>	 protected against vertically falling drops of water.	<b>01-05</b>	 impact < 1 joule
<b>2</b>	 protected against solid objects up to 12 mm e.g. fingers.	<b>2</b>	 protected against direct sprays of water up to 15° from the vertical.	<b>06</b>	 500 g 20 cm impact 1 joule
<b>3</b>	 protected against solid objects over 2.5 mm (tools+ small wires).	<b>3</b>	 protected against sprays to 60° from the vertical.	<b>07</b>	 500 g 40 cm impact 2 joule
<b>4</b>	 protected against solid objects over 1mm (tools+ small wires).	<b>4</b>	 protected against water sprayed from all directions - limited ingress permitted.	<b>08</b>	 1.7 kg 29.5 cm impact 5 joule
<b>5</b>	 protected against dust - limited ingress permitted (no harmful deposit).	<b>5</b>	 protected against low pressure jets of water from all directions - limited ingress permitted.	<b>09</b>	 5 kg 20 cm impact 10 joule
<b>6</b>	 totally protected against dust.	<b>6</b>	 protected against strong jets of water e.g. for use on shipdecks - limited ingress permitted.	<b>10</b>	 5 kg 40 cm impact 20 joule
		<b>7</b>	 15 cm min 1 m protected against the affects of immersion between 15 cm and 1 m.		
		<b>8</b>	 1 m protected against long periods of immersion under pressure.		

## CUSTOMISATION SERVICES

Fibox is a leading innovator, designer and manufacturer of enclosures. Our products are marketed in over 40 countries world wide. We provide superior, cost effective solutions for protecting electrical and electronic equipment operating in hostile environments.

To increase the range and flexibility of our package solutions, Fibox has developed a comprehensive range of services, permitting cost effective customisation for specific applications.

The two most important of these are machining services and customised tooling.

Our sophisticated CNC machinery can supply enclosures with holes, cutouts and openings to your specification. This solution is best suited for small to medium volumes of enclosures.

For large OEM volumes, our sophisticated, multiple slide tooling permits cost effective modification of any side of the enclosure. In this way, the OEM can have his custom product based upon a standard Fibox enclosure. The OEM will save both money and development time, enabling him to concentrate on product sales.

The [www.fibox.com](http://www.fibox.com) web site provides you the fastest route for choosing Fibox enclosures and accessories. Our interactive program guides you to the correct enclosure and accessories for your application. Technical data and drawing files (DWG, IGS, and DXF ) allow the engineer to design and customise quickly.

*See also page 14.*

Fibox can customise your enclosures making them completely ready for your application.

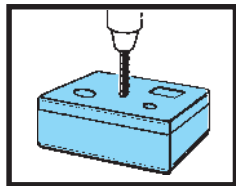

Machining services

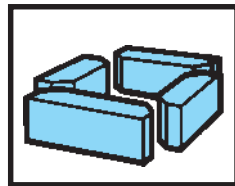

Customised tooling

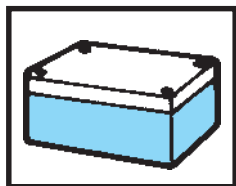

Coloured enclosures

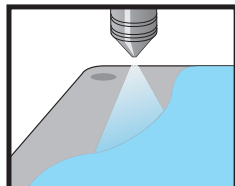

Painted enclosures

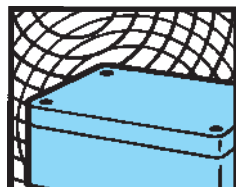

EMC shielding

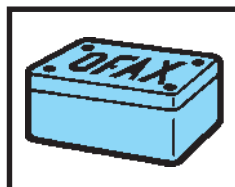

Printed enclosures





# FIBOX MNX

FIBOX MNX







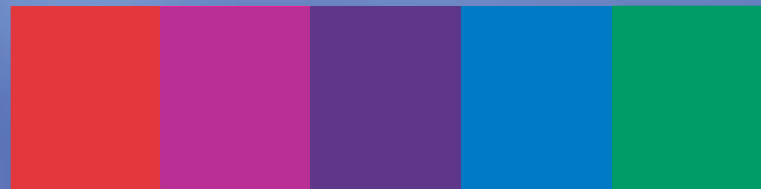





The FIBOX MNX range of enclosures represents the culmination of 35 years experience in enclosure design and manufacture. Unique tooling defines a new "State of the Art" for injection moulding. The FIBOX MNX polycarbonate and ABS range has been designed to house and protect electrical and electronic components in hostile environments. Three body depths, and up to 4 cover choices per body size, create over 240 variations.

Covers are available opaque or transparent "smoked grey". A wide selection of accessories is available including a hinged "Swing Out" inner panel, the "Swing Panel".





# FIBOX MNX PC

FIBOX MNX POLYCARBONATE PC: IP 66/67 and IP 66, IK 08	Z mm	C mm	Including: Enclosure cover with cover screws and wing heads for cover screws, base with mounting plate screws and gasket.			B x A L x S mm
			ORDER SYMBOL		ORDER SYMBOL	
			Grey cover		Smoked transparent cover	
PC 95 L / PC 95 H 	35 50 60 75	28.8 45.6 53.8 70.6	PC 95/35 LG PC 95/50 LG PC 95/60 HG PC 95/75 HG		PC 95/35 LT PC 95/50 LT PC 95/60 HT PC 95/75 HT	B x A 70 x 45  L x S 83.5 x 83.5
PC 100 L 	35 50 75 100	24.1 41.0 61.0 90.9	PC 100/35 LG PC 100/50 LG PC 100/75 LG PC 100/100 LG		PC 100/35 LT PC 100/50 LT PC 100/75 LT PC 100/100 LT	B x A 90 x 40  L x S 113.5 x 63.5
PC 100 H 	60 75 100 125	44.5 61.0 86.3 111.3	PC 100/60 HG PC 100/75 HG PC 100/100 HG PC 100/125 HG		PC 100/60 HT PC 100/75 HT PC 100/100 HT PC 100/125 HT	B x A 90 x 40  L x S 113.5 x 63.5
PC 125 L 	35 50 75 100	24.0 40.9 65.9 90.9	PC 125/35 LG PC 125/50 LG PC 125/75 LG PC 125/100 LG		PC 125/35 LT PC 125/50 LT PC 125/75 LT PC 125/100 LT	B x A 90 x 90  L x S 113.5 x 113.5
PC 125 H 	60 75 100 125	44.4 61.0 86.2 111.3	PC 125/60 HG PC 125/75 HG PC 125/100 HG PC 125/125 HG		PC 125/60 HT PC 125/75 HT PC 125/100 HT PC 125/125 HT	B x A 90 x 90  L x S 113.5 x 113.5
PC 150 L 	35 50 75 100 125	23.6 41.0 65.9 90.9 115.5	PC 150/35 LG PC 150/50 LG PC 150/75 LG PC 150/100 LG PC 150/125 LG		PC 150/35 LT PC 150/50 LT PC 150/75 LT PC 150/100 LT PC 150/125 LT	B x A 140 x 90  L x S 163.5 x 113.5
PC 150 H 	60 75 100 125 150	44.0 61.3 86.3 111.3 135.9	PC 150/60 HG PC 150/75 HG PC 150/100 HG PC 150/125 HG PC 150/150 HG		PC 150/60 HT PC 150/75 HT PC 150/100 HT PC 150/125 HT PC 150/150 HT	B x A 140 x 90  L x S 163.5 x 113.5
PC 175 H 	60 75 100 125 150	44.0 61.0 86.3 111.0 135.9	PC 175/60 HG PC 175/75 HG PC 175/100 HG PC 175/125 HG PC 175/150 HG		PC 175/60 HT PC 175/75 HT PC 175/100 HT PC 175/125 HT PC 175/150 HT	B x A 140 x 140  L x S 163.5 x 163.5
PC 200 H 	63 75 100 150	47.5 61.2 86.3 135.9	PC 200/63 HG PC 200/75 HG PC 200/100 HG PC 200/150 HG		PC 200/63 HT PC 200/75 HT PC 200/100 HT PC 200/150 HT	B x A 215 x 140  L x S 238.5 x 163.5
PC 200 XH 	88 100 125 175	71.5 86.8 111.9 161.5	PC 200/88 XHG PC 200/100 XHG PC 200/125 XHG PC 200/175 XHG		PC 200/88 XHT PC 200/100 XHT PC 200/125 XHT PC 200/175 XHT	

External height **Y** External width **X** External depth **Z** Free internal mounting height **C** Mounting plate assembly **B** x **A** Wall mounting **L** x **S**

L (low base) = enclosure with the low 25 mm base, H (high base) = enclosure with the high 50 mm base, XH (extra high base) = enclosure with the extra high 75 mm base, T = smoked transparent cover with black cover screws and black wing heads, G = grey cover with grey cover screws and grey wing heads.

# FIBOX MNX PC

FIBOX MNX

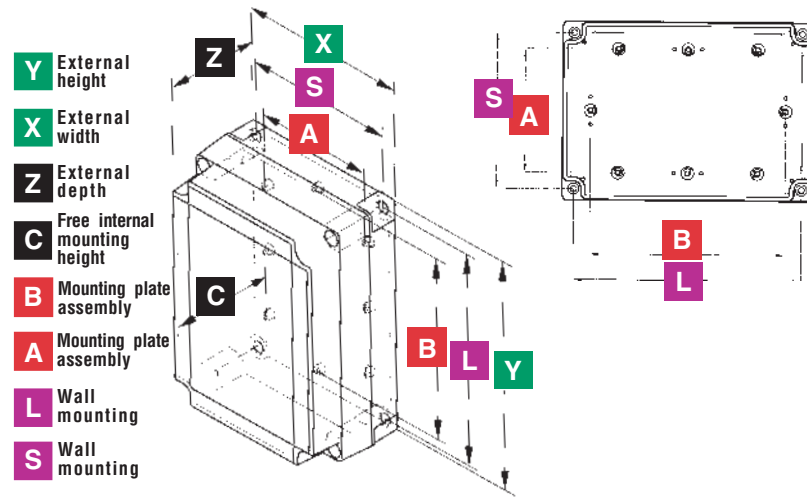

### SYMBOLS AND ABBREVIATIONS

PC 100 / 60 L G	Cover G = Grey T = Smoked grey transparent
	Base height L= Low 25 mm H= High 50 mm XH= Extra high 75 mm
	Total height = base + cover
	Size (length + width/2)
	Enclosure range/type
PC	Smooth sides
ABS	Smooth sides
PCM	Sides with metric knock-outs

## FIBOX MNX F COVER FOR MEMBRANE KEYBOARDS

Please order separately: cover II 150/10 GF or II 175/10 GF, appropriate enclosure base (see chart below) and cover screw set. For 150L bases use MBS LL -screw set and for 150H and 175H bases MBS LH set. Screw sets include 4 x grey cover screws, 4 x grey wing heads and 4 x mounting plate screws.



<b>Y</b> x <b>X</b> mm	<b>Z</b> mm	<b>C</b> mm	ORDER SYMBOL/ Base	PRODUCT	<b>B</b> x <b>A</b> <b>L</b> x <b>S</b> mm
180 x 130	35	23,6	PC 150L	PC low base	140 x 90 163.5 x 113.5
			A 150L	Low ABS base	
180 x 130	60	44,0	PC 150H	PC base	140 x 90 163.5 x 113.5
			PCM 150	PC base with metric knock-outs	
			A 150H	ABS base	
180 x 180	60	44,0	PC 175H	PC base	140 x 140 163.5 x 163.5
			PCM 175	PC base with metric knock-outs	
			A 175H	ABS base	





## FIBOX MNX PCM WITH METRIC KNOCK-OUTS

Amount of metric knock-outs in FIBOX MNX PCM:

<b>Y</b> x <b>X</b> mm	ORDER SYMBOL	KNOCK-OUT OPENINGS Long side	KNOCK-OUT OPENINGS Short side
		Number of openings x metric size	Number of openings x metric size
100 x 100	PCM 95	2 x M20	-
130 x 80	PCM 100	2 x M32/M20	1 x M25/M16
130 x 130	PCM 125	2 x M32/M20	2 x M25/M16
180 x 130	PCM 150	3 x M25/M16	2 x M32/M20
180 x 180	PCM 175	3 x M32/M20	3 x M25/M16
255 x 180	PCM 200	3 x M25/M16 + 2 x M32/M20	3 x M32/M20
255 x 180	PCM 200X	8 x M20, 1 x /M50/M32	2 x M32/M20, 1 x M20

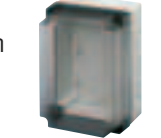
For more information, please see next page.

## FIBOX MNX PCM WITH METRIC KNOCK-OUTS







FIBOX MNX POLYCARBONATE PC: IP 66/67 and IP 66, IK 08	Z mm	C mm	Including: Enclosure cover with cover screws and wing heads for cover screws, base with mounting plate screws and gasket.		B x A L x S mm
			ORDER SYMBOL	ORDER SYMBOL	
			Grey cover	Smoked transparent cover	
<b>PCM 95</b> Y x X 100 mm 100 mm 	60 75	53.8 70.6	PCM 95/60 G PCM 95/75 G	PCM 95/60 T PCM 95/75 T	B x A 70 x 45  L x S 83.5 x 83.5
<b>PCM 100</b> Y x X 130 mm 80 mm 	60 75 100 125	44.5 61.0 86.3 111.3	PCM 100/60 G PCM 100/75 G PCM 100/100 G PCM 100/125 G	PCM 100/60 T PCM 100/75 T PCM 100/100 T PCM 100/125 T	B x A 90 x 40  L x S 113.5 x 63.5
<b>PCM 125</b> Y x X 130 mm 130 mm 	60 75 100 125	44.4 61.0 86.2 111.3	PCM 125/60 G PCM 125/75 G PCM 125/100 G PCM 125/125 G	PCM 125/60 T PCM 125/75 T PCM 125/100 T PCM 125/125 T	B x A 90 x 90  L x S 113.5 x 113.5
<b>PCM 150</b> Y x X 180 mm 130 mm 	60 75 100 125 150	44.0 61.0 86.3 111.3 135.9	PCM 150/60 G PCM 150/75 G PCM 150/100 G PCM 150/125 G PCM 150/150 G	PCM 150/60 T PCM 150/75 T PCM 150/100 T PCM 150/125 T PCM 150/150 T	B x A 140 x 90  L x S 163.5 x 113.5
<b>PCM 175</b> Y x X 180 mm 180 mm 	60 75 100 125 150	44.0 61.0 86.3 111.3 135.9	PCM 175/60 G PCM 175/75 G PCM 175/100 G PCM 175/125 G PCM 175/150 G	PCM 175/60 T PCM 175/75 T PCM 175/100 T PCM 175/125 T PCM 175/150 T	B x A 140 x 140  L x S 163.5 x 163.5
<b>PCM 200</b> Y x X 255 mm 180 mm 	63 75 100 150	47.5 61.2 86.3 135.9	PCM 200/63 G PCM 200/75 G PCM 200/100 G PCM 200/150 G	PCM 200/63 T PCM 200/75 T PCM 200/100 T PCM 200/150 T	B x A 215 x 140  L x S 238.5 x 163.5
<b>PCM 200 X</b> Y x X 255 mm 180 mm 	88 100 125 175	71.5 86.8 111.9 161.5	PCM 200/88 XG PCM 200/100 XG PCM 200/125 XG PCM 200/175 XG	PCM 200/88 XT PCM 200/100 XT PCM 200/125 XT PCM 200/175 XT	

External height **Y** External width **X** External depth **Z** Free internal mounting height **C** Mounting plate assembly **B** x **A** Wall mounting **L** x **S**

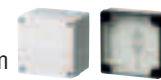
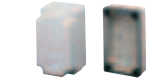
Enclosure with the high 50 mm base, X (extra high base) = enclosure with the extra high 75 mm base, T= smoked transparent cover with black cover screws and black wing heads, G= grey cover with grey cover screws and grey wing heads.

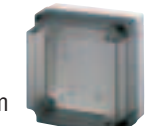
# FIBOX MNX ABS

FIBOX MNX

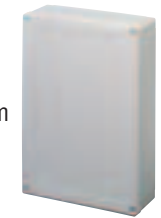
FIBOX MNX ABS ABS: IP 66/67 and IP 66, IK 07	Z mm	C mm	Including: Enclosure cover with cover screws and wing heads for cover screws, base with mounting plate screws and gasket.			B x A
			ORDER SYMBOL		ORDER SYMBOL	L x S
			Grey cover		Smoked transparent cover	mm
ABS 95 L / ABS 95 H 	35	28.8	ABS 95/35 LG		ABS 95/35 LT	B x A
	50	45.6	ABS 95/50 LG		ABS 95/50 LT	70 x 45
	60	53.8	ABS 95/60 HG		ABS 95/60 HT	L x S
	75	70.6	ABS 95/75 HG		ABS 95/75 HT	83.5 x 83.5
ABS 100 L 	35	24.1	ABS 100/35 LG		ABS 100/35 LT	B x A
	50	41.0	ABS 100/50 LG		ABS 100/50 LT	90 x 40
	75	61.0	ABS 100/75 LG		ABS 100/75 LT	L x S
	100	90.9	ABS 100/100 LG		ABS 100/100 LT	113.5 x 63.5
ABS 100 H 	60	44.5	PC 100/60 HG		ABS 100/60 HT	B x A
	75	61.0	PC 100/75 HG		ABS 100/75 HT	90 x 40
	100	86.3	PC 100/100 HG		ABS 100/100 HT	L x S
	125	111.3	PC 100/125 HG		ABS 100/125 HT	113.5 x 63.5
ABS 125 L 	35	24.0	ABS 125/35 LG		ABS 125/35 LT	B x A
	50	40.9	ABS 125/50 LG		ABS 125/50 LT	90 x 90
	75	65.9	ABS 125/75 LG		ABS 125/75 LT	L x S
	100	90.9	ABS 125/100 LG		ABS 125/100 LT	113.5 x 113.5
ABS 125 H 	60	44.4	ABS 125/60 HG		ABS 125/60 HT	B x A
	75	61.0	ABS 125/75 HG		ABS 125/75 HT	90 x 90
	100	86.2	ABS 125/100 HG		ABS 125/100 HT	L x S
	125	111.3	ABS 125/125 HG		ABS 125/125 HT	113.5 x 113.5
ABS 150 L 	35	23.6	ABS 150/35 LG		ABS 150/35 LT	B x A
	50	41.0	ABS 150/50 LG		ABS 150/50 LT	140 x 90
	75	65.9	ABS 150/75 LG		ABS 150/75 LT	L x S
	100	90.9	ABS 150/100 LG		ABS 150/100 LT	163.5 x 113.5
	125	115.5	ABS 150/125 LG		ABS 150/125 LT	
ABS 150 H 	60	44.0	ABS 150/60 HG		ABS 150/60 HT	B x A
	75	61.3	ABS 150/75 HG		ABS 150/75 HT	140 x 90
	100	86.3	ABS 150/100 HG		ABS 150/100 HT	L x S
	125	111.3	ABS 150/125 HG		ABS 150/125 HT	163.5 x 113.5
	150	135.9	ABS 150/150 HG		ABS 150/150 HT	
ABS 175 H 	60	44.0	ABS 175/60 HG		ABS 175/60 HT	B x A
	75	61.0	ABS 175/75 HG		ABS 175/75 HT	140 x 140
	100	86.3	ABS 175/100 HG		ABS 175/100 HT	L x S
	125	111.0	ABS 175/125 HG		ABS 175/125 HT	163.5 x 163.5
	150	135.9	ABS 175/150 HG		ABS 175/150 HT	
ABS 200 H 	63	47.5	ABS 200/63 HG		ABS 200/63 HT	B x A
	75	61.2	ABS 200/75 HG		ABS 200/75 HT	215 x 140
	100	86.3	ABS 200/100 HG		ABS 200/100 HT	L x S
	150	135.9	ABS 200/150 HG		ABS 200/150 HT	238.5 x 163.5
	88	71.5	ABS 200/88 XHG		ABS 200/88 XHT	
	100	86.8	ABS 200/100 XHG		ABS 200/100 XHT	
	125	111.9	ABS 200/125 XHG		ABS 200/125 XHT	
175	161.5	ABS 200/175 XHG		ABS 200/175 XHT		

External height **Y** External width **X** External depth **Z** Free internal mounting height **C** Mounting plate assembly **B** x **A** Wall mounting **L** x **S**

L (low base) = enclosure with the low 25 mm base, H (high base) = enclosure with the high 50 mm base, XH (extra high base) = enclosure with the extra high 75 mm base, T = smoked transparent cover with black cover screws and black wing heads, G = grey cover with grey cover screws and grey wing heads.















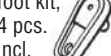

## TECHNICAL INFORMATION

PROPERTY	POLYCARBONATE (PC)	ABS	CONFORMITY TO STANDARDS (UL, CSA, CE, Lloyds, BV, FI)
Ingress Protection (EN 60529)	IP66/IP 67 and IP66	IP66/67 and IP66	<b>USA</b> Enclosures for Electrical Equipment PC: UL Type 1, 4, 4X, 6 (12 and 13) (UL 50/508) ABS: NEMA 1, 4, 4X, 6 (12 and 13)
Impact Resistance (EN 50102)	IK 08	IK 07	<b>Canada</b> Industrial Control Equipment Enclosures for Electrical Equipment/ULc
Temperature Range Celsius (short term)	-40°...120°C	-40°...80°C	<b>Europe</b> Enclosures for Switch Gear and Control Gear Assemblies EN 50298:1998
Temperature Range Celsius (continuous)	-40°...80°C	-40°...60°C	<b>Europe</b> Safety of Information Technology Equipment EN 60950
Temperature Range Fahrenheit (short term)	-40°...250°F	-40°...175°F	
Temperature Range Fahrenheit (continuous)	-40°...175°F	-40°...140°F	
Electrical Insulation	Totally insulated <input type="checkbox"/>	Totally insulated <input type="checkbox"/>	<b>Australia</b> Enclosures for switch gear and control gear AS 3132-1991
Light Grey Parts Colour	RAL 7035	RAL 7035	
Transparent Clear PC Cover	Industry Grey	Industry Grey	
Cover Screws	Smoked Grey	Smoked Grey	
Cover Screws	Black or Grey	Black or Grey	
Cover Screws	Polyamide (PA)	Polyamide (PA)	
Gasket	PUR/TPE	PUR/TPE	
Enclosure Flammability Rating	UL94-5V	UL94HB	UL 746 C 5 in. vertical flame test IEC 695-2-1, Self-extinguishing
Glow Wire Test	960°C	650°C	
Non-toxicity	Halogen Free	Halogen Free	
UV resistance	UL 508		
Chemical Resistance *	720 hours in "Weatherometer" Good	Good	

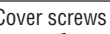
Data subject to change without notice. \*Consult separate raw material data for more detailed information

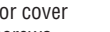
## ACCESSORIES

Product	Order symbol	Size mm	
MNX front plate 	FP A 100/130 FP A 125/130 FP A 150/180 FP A 175/180 FP A 200/180	120 x 62 120 x 112 170 x 112 170 x 162 237 x 170	
MNX front plate hinge series, 2 pcs 	HFP 130 HFP 180	130 180	
incl. screws			
Mounting plate 	MIV 95 MIV 100 MIV 125 MIV 150 MIV 175 MIV 200	66 x 80 98 x 48 98 x 98 148 x 98 148 x 148 223 x 148	
Mounting rail DIN 35 	B-3 MIV 5 MIV 10 MIV 15 MIV 20	35 x 80 35 x 50 35 x 100 35 x 150 35 x 225	
Mounting rail DIN 15 	MIN 5 MIN 10 MIN 15 MIN 20	15 x 50 15 x 100 15 x 150 15 x 225	
Mounting foot kit, 4 pcs. incl. screws 	FP 22046		
Inspection windows 	L02 L04 L06 L08 L10	60 x 77 96 x 77 130 x 77 162 x 77 199 x 77	
Plastic hinges (2 pcs) 	TH A		
incl. mounting screws			
MNX sealing plug, grey 	DP 14553		
MNX sealing plug, black 	DP 14553B		
Water plug 	MB 12189		
Cover plug 	MB 14560		
Ventilation device 	MB 10631		
Cover screws 	SS 14550L SS 14551H  SS 14550BL SS 14551BH		
Wing heads for cover screws 	MB 14552 MB 14552B		
Mounting plate screws 	MR ZN 2.9x6.5 KN 3.9x9.5	2.9 x 6.5 3.9 x 9.5	

# FIBOX MNX

## POLYCARBONATE AND ABS ENCLOSURE

### MULTI PURPOSE MOUNTING PODS

The 50 mm (H) base features 3 levels for component mounting. The highest level provides component clearance under the Printed Circuit Board. The middle level is ideal for DIN rail mounting. The lowest level permits snap-in mounting of PCB's.

Please ask for Fibox mounting and machining service for terminal blocks and cable glands.

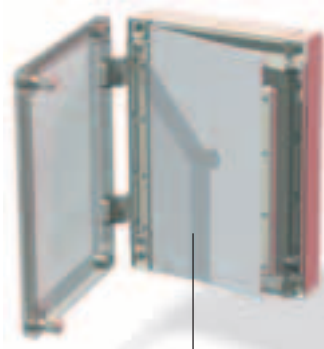

### VERSATILE COVERS

Grey opaque or smoked transparent polycarbonate covers provide a stylish finish to any installed equipment. Tooling may be cost effectively changed to customise covers for volume OEM applications.



### FIBOX MNX PCM

Enclosure features metric knock-outs moulded in place for easy wiring.

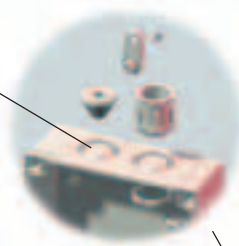

**SWING  
PANEL  
PANEL**

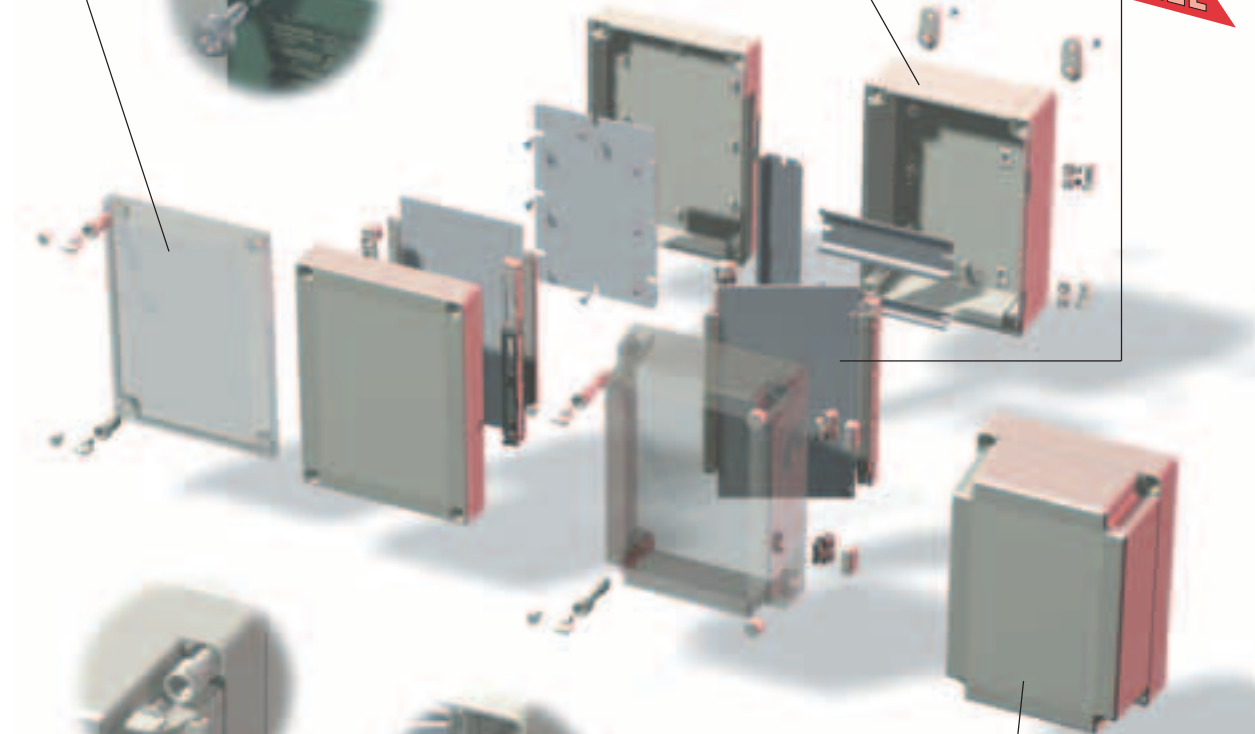

### FUNCTIONAL COVER SCREWS

The enclosure is supplied with corrosion free plastic cover screws. A wing head screw can be snapped in place for opening without tools. Grey covers are supplied with grey screws. Smoked transparent covers are supplied with black screws.



### HINGED INNER PANEL

For instrumentation mounting, aluminum inner panels can be hinged right or left. Unique brackets allow mounting in either base or cover. The brackets permit mounting at variable depths.



### RUGGED HINGE

An optional corrosion free hinge is available. Mounted on the outside, fixing screws are hidden by decorative covers.



### MEMBRANE KEY-BOARD RECESS

The cover features a slightly recessed area ideal for overlays and membrane key pads. Special cover available for sizes 150 and 175, see page 9.



**FIBOX MNX**

## FIBOX CUSTOMIZING SERVICES

### FIBOX MACHINING SERVICES

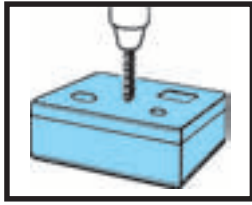

To increase the range and flexibility of our enclosure solutions, Fibox has developed a comprehensive range of services, permitting cost effective customisation for specific applications. The two most important of these are machining services and customised tooling.

Our sophisticated CNC machinery can supply enclosures with holes, cutouts and openings to your specification. This solution is best suited for small to medium volumes of enclosures. Fibox knowledge of enclosure materials ensures that the machining method is compatible with the chosen enclosure material.



Prior to machining a production run, Fibox requires customer approved drawings. Either the customer or Fibox can create these drawings. Enclosure specifications and technical data are available on our latest CD-ROM or on the WEB [WWW.FIBOX.COM](http://WWW.FIBOX.COM). CAD support drawings are available in IGES, DWG and DXF formats adaptable to your design system requirements.

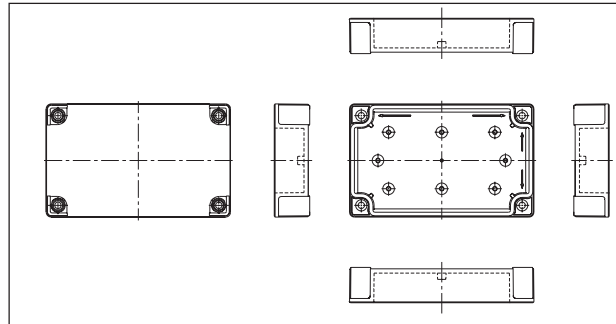

### CUSTOMISED TOOLING

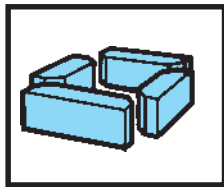

For large volume OEM requirements, it is often possible to customise the moulding of a standard product to meet the OEM's specific needs. Provided the mould is a sophisticated multiple slide mould, any enclosure side may be customised without requiring an entirely new mould. It is important that the OEM consult with Fibox early in your design process to determine what, if any, mould change restrictions exist.

Altering an existing Fibox mould can be a very cost effective alternative to creating a custom mould. In essence, you lease a high volume, standard product mould with minimal initial tooling cost. This can shorten product development times and permit customising even those products with projected short life cycles. Your new product reaches the market sooner.

### COLOURED PLASTIC ENCLOSURES

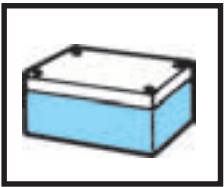

Fibox offers custom moulding of standard enclosures in customer specified colours. Standard colour specifications are based upon the RAL system, however custom colour matching is possible. The type of plastic has significant impact on colour match, colour consistency and cost. Please consult your Fibox representative for guidance.

Custom colour molding becomes economical in volumes over 1000 pieces, but lower volumes are possible. Cost adders are based upon increased raw material costs, plus the cost to prepare moulds prior to production and then clean the moulds after production. These mould preparation costs are highly volume dependent.

### PAINTED ENCLOSURES

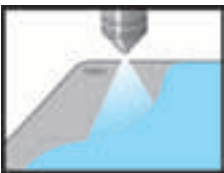

Painting enclosures is recommended for plastic enclosures when volumes do not justify custom moulding. Critical colour matching, if required, is also easier to accomplish with paint. Paint type is dependent upon the choice of enclosure material. Please consult your Fibox representative for guidance.

### EMC - PLASTIC ENCLOSURES

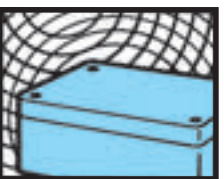

Plastic enclosures can be prepared to provide EMC shielding. Various methods are available, but painting the internal surface with Ni conductive paint is the preferred method. This coating, combined with a conductive gasket material such as CHO-SEAL 1350, can provide significant shielding levels. Proper selection of materials is very application specific. Please consult your Fibox representative for guidance.

### PRINTED ENCLOSURES



Silk screen printing is recommended for enclosure batches of less than 1000 pieces. This method is mainly suitable for flat surfaces, and can be used for large areas.

Tampo printing is the best solution for volumes greater than 1000 pieces. It is suitable for printing on both flat and curved surfaces of limited size. Tampo printing is also ideal for tight spots like the inside surface of the enclosure.

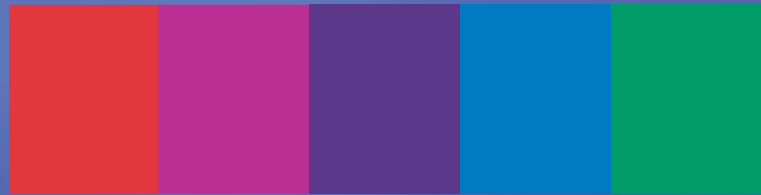

# FIBOX PICCOLO

FIBOX PICCOLO





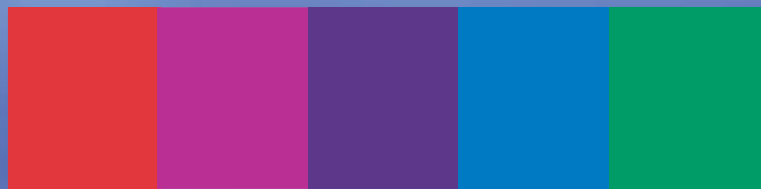



The FIBOX PICCOLO range of enclosures is specifically designed for housing push buttons, terminal blocks, motor starters and electronic devices. They are also ideal for mounting and protecting process control sensors and switches. There are six basic sizes and a choice of two cover depths. Push Button configurations are available as standard. FIBOX PICCOLO is available in polycarbonate or ABS.  
The enclosures are rated EN 60529 IP66/IP67.





# FIBOX PICCOLO

FIBOX PICCOLO PC: IP66 / IP67, IK 08 ABS: IP66 / IP67, IK 07	Z mm	C mm	Including: Enclosure base, cover with PUR gasket, 4 cover screws, and mounting screws.				B x A
			ORDER SYMBOL		ORDER SYMBOL		L x S
			Grey cover		Transparent cover		mm
<b>PICCOLO B</b> Y x X 110 mm 80 mm 	65	52	PC B 65 G		PC B 65 T	B	
	85	72	PC B 85 G		PC B 85 T	75	
	65	52	ABS B 65 G		ABS B 65 T	L x S	
	85	72	ABS B 85 G		ABS B 85 T	90 x 60	
<b>PICCOLO C</b> Y x X 140 mm 80 mm 	65	52	PC C 65 G		PC C 65 T	B	
	85	72	PC C 85 G		PC C 85 T	105	
	65	52	ABS C 65 G		ABS C 65 T	L x S	
	85	72	ABS C 85 G		ABS C 85 T	120 x 60	
<b>PICCOLO D</b> Y x X 170 mm 80 mm 	65	52	PC D 65 G		PC D 65 T	B	
	85	72	PC D 85 G		PC D 85 T	135	
	65	52	ABS D 65 G		ABS D 65 T	L x S	
	85	72	ABS D 85 G		ABS D 85 T	150 x 60	
<b>PICCOLO F</b> Y x X 230 mm 80 mm 	65	52	PC F 65 G		PC F 65 T	B	
	85	72	PC F 85 G		PC F 85 T	195	
	65	52	ABS F 65 G		ABS F 65 T	L x S	
	85	72	ABS F 85 G		ABS F 85 T	210 x 60	
<b>PICCOLO H</b> Y x X 170 mm 140 mm 	95	81.7	PC H 95 G		PC H 95 T	B x A	
	95	81.7	ABS H 95 G		ABS H 95 T	130 x 100	
						L x S	
						152 x 122	
<b>PICCOLO M</b> Y x X 230 mm 140 mm 	95	81.7	PC M 95 G		PC M 95 T	B x A	
	95	81.7	ABS M 95 G		ABS M 95 T	190 x 100	
	125	111.7	PC MH 125 G		PC MH 125 T	S x L	
	125	111.7	ABS MH 125 G		ABS MH 125 T	212 x 122	

External height **Y**    External width **X**    External depth **Z**    Free internal mounting height **C**    Mounting plate assembly **B** x **A**    Wall mounting **L** x **S**

# FIBOX PICCOLO

**Y** External height

**X** External width

**Z** External depth

**C** Free internal mounting height

**B** Mounting plate assembly

**A** Mounting plate assembly

**L** Wall mounting

**S** Wall mounting

FP 22040 fastening lug measures

SYMBOLS AND ABBREVIATIONS

**PC B 65 T**

- Cover G = Grey
- T = Smoked grey
- Y = colour of the enclosure
- Total height = base + cover
- Enclosure size
- Enclosure range/type

PC polycarbonate smooth sides  
 ABS ABS grey, smooth sides  
 SABS ABS signal Y=yellow smooth sides

EMC polycarbonate, painted for EMC-shielding, smooth sides  
 PBPC polycarbonate, push buttons in cover 1 = one hole  
 1M = one hole miniature size

**FIBOX PICCOLO**

## PICCOLO EMC, PICCOLO YELLOW AND PICCOLO PUSH BUTTONS

FIBOX PICCOLO EMC POLYCARBONATE ENCLOSURE					
ORDER SYMBOL		DIMENSIONS mm			
EMC PC B 65 G		110 x 80 x 65	<b>REMOVING PRODUCT</b>		
EMC PC C 65 G		140 x 80 x 65			
EMC PC D 65 G		170 x 80 x 65			
EMC PC F 65 G		230 x 80 x 65			
EMC PC H 95 G		170 x 140 x 95			
EMC PC M 95 G		230 x 140 x 95			
FIBOX PICCOLO BUSH BUTTON ENCLOSURES					
PBPC B 85 G 1	∅ 30.5 MM	110 x 80 x 85	<b>REMOVING PRODUCT</b>		
PBPC D 85 G 2		170 x 80 x 85			
PBPC F 85 G 3		230 x 80 x 85			
PBPC H 95 G 4		170 x 140 x 95			
PBPC M 95 G 6		230 x 140 x 95			
PBPC B 85 G 1M		∅ 22.5 MM		110 x 80 x 85	
PBPC C 85 G 2M	140 x 80 x 85				
PBPC D 85 G 3M	170 x 80 x 85				
PBPC F 85 G 4M	230 x 80 x 85				
FIBOX PICCOLO SIGNAL ABS ENCLOSURE					
SABS B 65 Y				110 x 80 x 65	<b>REMOVING PRODUCT</b>
SABS C 65 Y		140 x 80 x 65			
SABS D 65 Y		170 x 80 x 65			
SABS F 65 Y		230 x 80 x 65			
SABS H 95 Y		170 x 140 x 95			
SABS M 95 Y		230 x 140 x 95			

A standard PICCOLO EMC shielded plastic enclosure family for fulfilling the newest European regulations of electromagnetic compatibility. Five different standard sizes available ex stock with 40 to 60 db attenuation through reliable Ni-coating inside the enclosure.



Choose PICCOLO PB Polycarbonate enclosures to house 30.5 mm or 22.5 mm pushbuttons in corrosive environments. Piccolo PB enclosures feature high impact resistance, stylish design, and light grey colour.

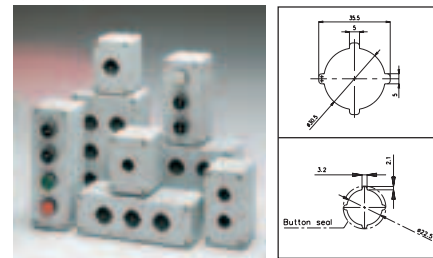

Bright Yellow PICCOLO enclosure with black cover screws for places where visible safety is needed.













Data subject to change without notice.

## TECHNICAL INFORMATION

PROPERTY	POLYCARBONATE (PC)	ABS	CONFORMITY TO STANDARDS (UL, CSA, CE, Lloyds, BV, FI)
Ingress Protection (EN 60529)	IP66/IP67	IP66/67	<b>USA</b> Enclosures for Electrical Equipment PC: UL Type 1, 4X, 6, 12 and 13 (UL 50/508) ABS: NEMA 1, 4, 4X, 6, 12 and 13
Impact Resistance (EN 50102)	IK 08	IK 07	<b>Canada</b> Industrial Control Equipment Enclosures for Electrical Equipment/ULc
Temperature Range (short term)	Celsius: -40°...120°C Fahrenheit: -40°...250°F	-40°...80°C -40°...175°F	<b>Europe</b> Enclosures for Switch Gear and Control Gear Assemblies EN 50298:1998
Temperature Range (continuous)	Celsius: -40°...80°C Fahrenheit: -40°...175°F	-40°...60°C -40°...140°F	<b>Europe</b> Safety of Information Technology Equipment EN 60950
Electrical Insulation	Totally insulated <input type="checkbox"/>	Totally insulated <input type="checkbox"/>	<b>Australia</b> Enclosures for switch gear and control gear AS 3132-1991
Light Grey Parts Colour	RAL 7035 Industry Grey	RAL 7035 Industry Grey	
Transparent Clear PC Cover	Clear Transparent	Clear Transparent	
Cover Screws	RAL 7035	RAL 7035	
Cover Screws	Polyamide (PA)	Polyamide (PA)	
Gasket	PUR	PUR	
Enclosure Flammability Rating	UL94-5V	UL94HB	UL 746 C 5 in. vertical flame test
Glow Wire Test	960°C	650°C	IEC 695-2-1, Self-extinguishing
Non-toxicity	Halogen Free	Halogen Free	
UV resistance	UL 508 720 hours in "Weatherometer"		
Chemical Resistance *	Good	Good	

Data subject to change without notice. \*Consult separate raw material data for more detailed information

## ACCESSORIES

Product	Order symbol	Size mm		
Mounting plate 	B-MP C-MP D-MP F-MP H-MP M-MP	80 x 54 110 x 54 140 x 54 200 x 54 125 x 94 185 x 94		
Mounting rail DIN 35 	B-3 CHM-3 DH-3 FM-3	35 x 80 35 x 110 35 x 140 35 x 200		
Inspection windows 	L02 L04 L06 L08 L10	60 x 77 96 x 77 130 x 77 162 x 77 199 x 77		
Ventilation device 	MB 10631			
Hinges 	TH A			
Hinges, 1 pair incl. screws 	PA 22039			
Mounting foot kit, 2 pcs incl. screws 	FP 22040			
Mounting foot kit, 4 pcs incl. screws 	FP 22046			
Screw sets 	MB S-20 KN MB S-40 KN MB S-20 BKN MB S-40 BKN			
Cover screws 	Grey S-20 S-40 Black S-20B S-40B	0.8 1.6 0.8 1.6	20 40 20 40	
Mounting screw 	KN 3.9 x 9.5			

## CUSTOMISATION

Enclosures can be machined, painted, screen printed and preassembled to meet your customisation requirements. Fibox's service centre offers complete CNC machining, hinge mounting, screen printing, assembly and much more. Our wide selection of enclosures and accessories can be customised to create a unique enclosure meeting your application requirements.

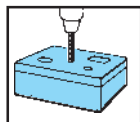



# FIBOX

## EURONORD

FIBOX EURONORD















The FIBOX EURONORD range of enclosures is specifically designed for housing DIN-rail mounted terminal blocks. Additionally, these enclosures are excellent for packaging sensors for process control applications. FIBOX EURONORD enclosures are available moulded from polycarbonate, ABS or polyester (GRP). FIBOX EURONORD enclosures are also available in cast aluminium. The enclosures are rated EN 60529 IP 66/67.





# FIBOX EURONORD II

FIBOX EURONORD

FIBOX EURONORD II PC: IP66 / IP67, IK 08/IK 07 ABS: IP66 / IP67, IK 07	Z x C	GREY COVER AND TRANSPARENT COVER		FIBOX EURONORD II PC: IP66 / IP67, IK 08/IK 07 ABS: IP66 / IP67, IK 07	Z x C	GREY COVER AND TRANSPARENT COVER	
	B x A	ORDER SYMBOL			B x A	ORDER SYMBOL	
	L x S mm				L x S mm		
050504 Y x X 52 mm 50 mm 	Z / C 40 x 30 B 16.4 L x S 40 x 38	PC 050504 AB 050504		121207 Y x X 122 mm 120 mm 	Z / C 65 x 54 B x A 98 x 83.5 L x S 110 x 90	PCT 121207 PC 121207 AB 121207	
050705 Y x X 65 mm 50 mm 	Z / C 45 x 35 B 38 L x S 53 x 38	PCT 050705 PC 050705 AB 050705		121210 Y x X 122 mm 120 mm 	Z / C 95 x 84 B x A 98 x 83.5 L x S 110 x 90	PCT 121210 PC 121210 AB 121210	
080807 Y x X 82 mm 80 mm 	Z / C 65 x 53.5 B x A 58 x 43.5 L x S 70 x 50	PCT 080807 PC 080807 AB 080807		121609 Y x X 160 mm 120 mm 	Z / C 90 x 78 B x A 90.5 x 120 L x S 148 x 88	PCT 121609 PC 121609 AB 121609	
081206 Y x X 120 mm 80 mm 	Z / C 55 x 42 B x A 81.5 x 58.0 L x S 108 x 50	PCT 081206 PC 081206 AB 081206		122008 Y x X 200 mm 120 mm 	Z / C 75 x 62 B x A 160.5 x 90.5 L x S 188 x 89	PCT 122008 PC 122008 AB 122008	
081607 Y x X 160 mm 80 mm 	Z / C 65 x 54 B x A 121.5 x 58 L x S 148 x 50	PCT 081607 PC 081607 AB 081607		152008 Y x X 201 mm 151 mm 	Z / C 80 x 68.5 B x A 160 x 118 L x S 189 x 118	PCT 152008 PC 152008 AB 152008	
081610 Y x X 160 mm 80 mm 	Z / C 95 x 84 B x A 121.5 x 58 L x S 148 x 50	PCT 081610 PC 081610 AB 081610		162509 Y x X 250 mm 160 mm 	Z / C 90 x 78 B x A 201.5 x 138.5 L x S 238 x 130	PCT 162509 PC 162509 AB 162509	



External height **Y** External width **X** External depth **Z** Free internal mounting height **C** Mounting plate assembly **B** x **A** Wall mounting **L** x **S**

Including: Enclosure body, cover with PUR gasket, cover screws, and mounting screws. T= smoked transparent cover G= grey cover

# FIBOX EURONORD II

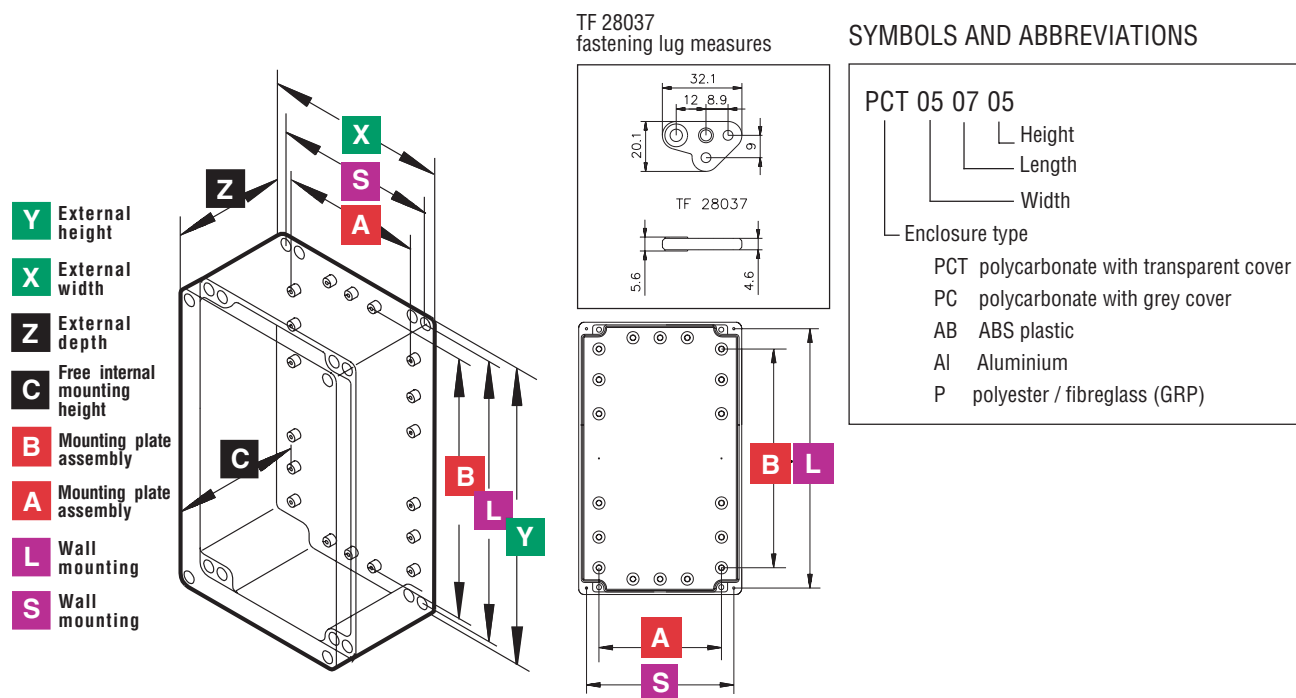
**FIBOX EURONORD**



FIBOX EURONORD II PC: IP66 / IP67, IK 08/IK 07 ABS: IP66 / IP67, IK 07	Z x C	GREY COVER AND TRANSPARENT COVER
	B x A	ORDER SYMBOL
	L x S mm	
162513 Y x X 250 mm 160 mm 	Z / C 125 x 113 B x A 201.5 x 138.5 L x S 238 x 130	PCT 162513 PC 162513 AB 162513
233009 Y x X 300 mm 230 mm 	Z / C 87 x 75 B x A 255 x 198 L x S 288 x 200	PCT 233009 PC 233009 AB 233009
233011 Y x X 300 mm 230 mm 	Z / C 110 x 98 B x A 255 x 198 L x S 288 x 200	PCT 233011 PC 233011 AB 233011

### CIRCUIT BOARD BRACKET

Printed circuit boards and mounting plates often need special mounting supports that offer flexibility in positioning the boards across the enclosure body. Mounting supports also raise the board above the enclosure bottom, especially effective when using two sided boards. This circuit board bracket has a standard E1 (IEC 297-3, DIN 41494) Eurocard screw mounting distance of 89 mm (3.5") accepting M2,5 to M4 screws. The bracket can also be used for nonstandard boards by separating the ends of the bracket (a) from the connector bridge (b). If the bracket is not needed, the adapter parts for each individual mounting pod size can be used only for raising the board above the enclosure body level.

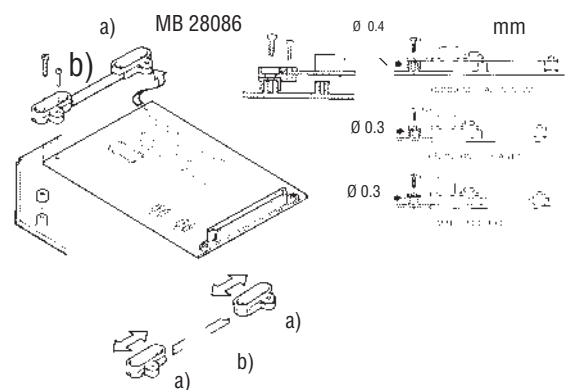

CIRCUIT BOARD BRACKET		
ORDER SYMBOL	Standard Mounting Distance	Remarks
MB 28086	89 mm	Adapter for EURONORD, PICCOLO, MINI. Direct mount to EK, SOLID, EKI.

## FIBOX EURONORD II

### POLYCARBONATE AND ABS ENCLOSURES

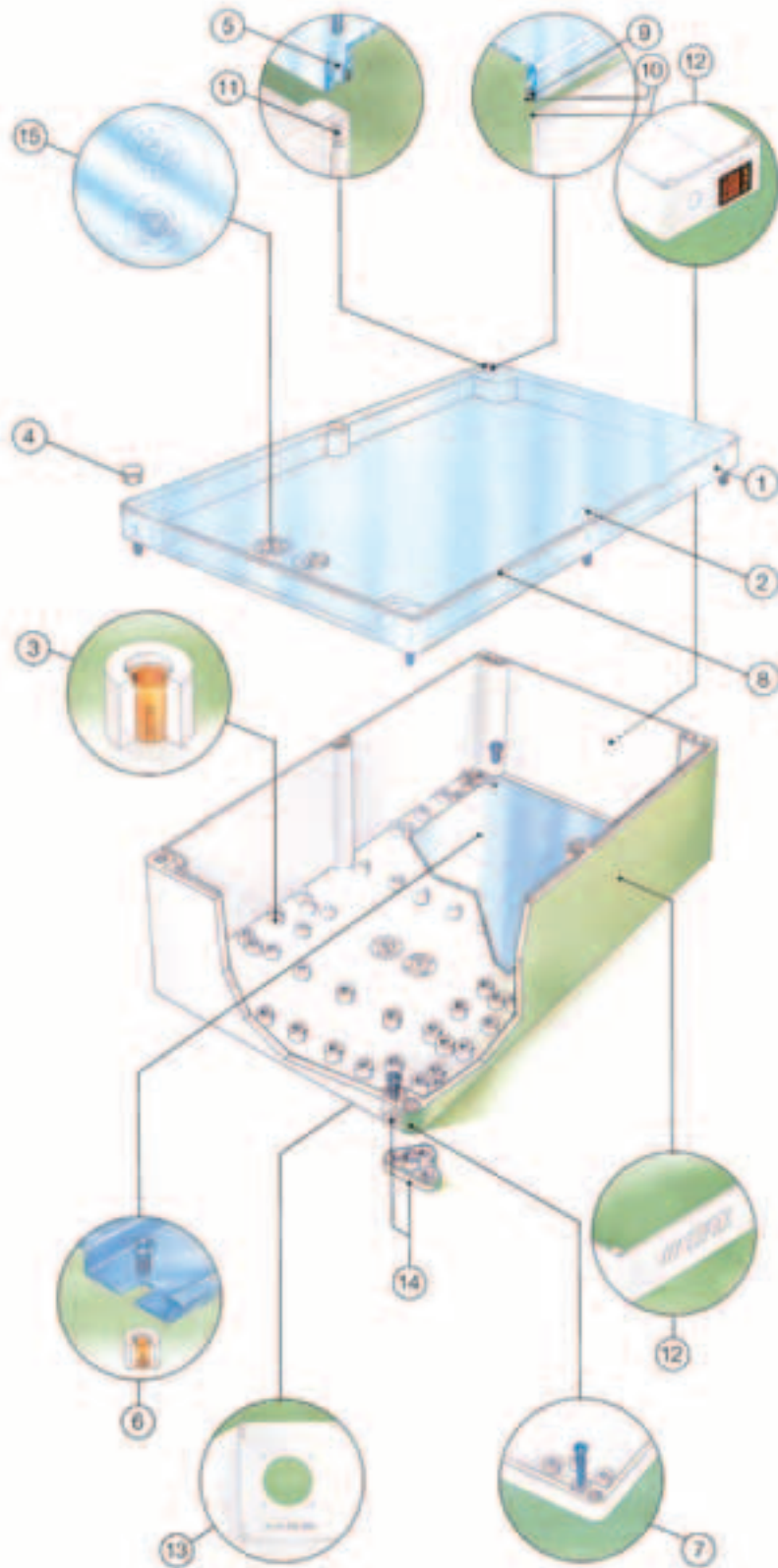

1. Enclosure covers are moulded with state of the art technology. Depending upon size, covers are injection moulded from the edge or the inside surface. The outer surface is free of "gate marks" creating a smooth area for labels, decals or screen printing.
2. Cover screws are designed for automatic assembly using normal tools or PosiDrive Phillips screwdrivers. Slightly ferrite, F1 stainless screws work with magnetised drivers. Screws fully tighten in 4 revolutions.
3. Fibox Euronorm II enclosures feature more mounting points than the competitors' products. F1 style screws are provided for mounting inner panels and Din rails. Enclosures feature low height mounting pods, thus maximising internal usable depth. Brass M3 inserts are also available.
4. Decorative cover plugs create a smooth finished appearance.
5. Cover screws are held captive, but are still removable.
6. Assorted mounting plates and Din rails are available.
7. Enclosures can be wall mounted through the base holes. This reduces both mounting area and possible vandalism. Mounting holes are outside the gasket area maintaining water tight protection.
8. The Euronorm II features a slightly bevelled edge design creating a modern look.
9. Robotically applied, foamed in place PUR gaskets are moulded into the unique designed gasket groove. The tight adhesion and low compression set of PUR gasket material ensures protection ratings of NEMA 4 and IP 66/67.
10. An extension strip structure reinforces the inner gasket groove edge, protecting against side impact.
11. Special injection moulded plastic threads allow the cover screws to fasten quickly, while preventing sticking and corrosion.
12. The enclosure sides have space for mounting switches, sensors, or cable glands. Smooth sides allow decals or screen printing of logos. Fibox can customise enclosures with cut-outs, drilled or machined holes, and knock-out openings to the customers specifications.
13. Customisation of the back and sides of the enclosure can be supplied by Fibox.
14. Optional wall mounting brackets (feet) allow 4 external mounting points for hanging the enclosure, even when the cover is in place.
15. Fibox is an ISO 9001 manufacturer. Each enclosure part (cover and base) bears a code number, indication of manufacturing date and type of plastic, i.e. PC, ABS, etc. These indications are moulded into the part for quality control purposes and for compliance with European recycling regulations.















## FIBOX EURONORD II

### TECHNICAL INFORMATION FOR EURONORD PC AND ABS







PROPERTY	POLYCARBONATE (PC)	ABS	CONFORMITY TO STANDARDS (UL, CSA, CE, Lloyds, BV, FI)
Ingress Protection (EN 60529)	IP66/IP67	IP66/67	<b>USA</b> Enclosures for Electrical Equipment PC: UL Type 1, 4, 4X, 12 and 13 (UL 50/508) ABS: NEMA 1, 4, 4X, 12 and 13
Impact Resistance (EN 50102)	IK 08/IK 07	IK 07	<b>Canada</b> Industrial Control Equipment Enclosures for Electrical Equipment/ULc
Temperature Range (short term)	Celsius 40°...120°C Fahrenheit 40°...250°F	-40°...80°C -40°...175°F	<b>Europe</b> Enclosures for Switch Gear and Control Gear Assemblies EN 50298:1998
Temperature Range (continuous)	Celsius -40°...80°C Fahrenheit -40°...175°F	-40°...60°C -40°...140°F	<b>Europe</b> Safety of Information Technology Equipment EN 60950
Electrical Insulation	Totally insulated ☐	Totally insulated ☐	<b>Australia</b> Enclosures for switch gear and control gear AS 3132-1991
Light Grey Parts Colour	RAL 7035 Industry Grey	RAL 7035 Industry Grey	
Transparent Clear PC Cover	Clear Transparent	Clear Transparent	
Cover Screws	Stainless steel	Stainless steel	
Gasket	PUR	PUR	
Enclosure Flammability Rating	UL94-5V	UL94HB	UL 746 C 5 in. vertical flame test
Glow Wire Test	960°C	650°C	IEC 695-2-1, Self-extinguishing
Non-toxicity	Halogen Free	Halogen Free	
UV resistance	UL 508 720 hours in "Weatherometer"		
Chemical Resistance *	Good	Good	

Data subject to change without notice. \*Consult separate raw material data for more detailed information

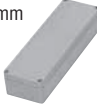
### ACCESSORIES FOR EURONORD PC AND ABS

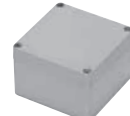
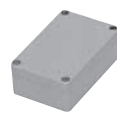
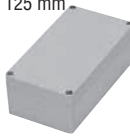
Product	Order symbol	Size mm		
 Mounting plate	TM 0505	26 x 48		
	TM 0507	26 x 57		
	TM 0808	56 x 71		
	TM 0812	71 x 94		
	TM 0816	71 x 134		
	TM 1212	96 x 111		
	TM 1216	111 x 134		
	TM 1220	111 x 174		
	TM 1520	141 x 174		
	TM 1625	151 x 214		
TM 2330	221 x 274			
 Mounting rail DIN 15	TRM 0507	15 x 48		
	TRM 0808	15 x 68		
	TRM 0812	15 x 106		
	TRM 0816	15 x 146		
	TRM 1212	15 x 110		
 Mounting rail DIN 35	TRH 1212	35 x 110		
	TRH 1216	35 x 146		
	TRH 1220	35 x 186		
	TRH 1520	35 x 170		
	TRH 24	35 x 226		
	TRH 2330	35 x 285		
 Plastic hinges (2 pcs)	TH A			
 Wall fastening lug set	TF 28037			
 Inspection windows	L02	60 x 77		
	L04	96 x 77		
	L06	130 x 77		
	L08	162 x 77		
	L10	199 x 77		
 Brass insert M3 for PC, PCT and ABS enclosures, set of 4 pcs	MRS 28084 set	M3		
	 Mounting screw	MR 28036EU	4.5 x 8.0	
		MR 28036EU		
	 Sealing pin	SB 28088		
		SB 28088		
	 Decoration plug for PC, PCT and ABS enclosures	MB 28018		
		MB 28018		
	 Water plug	MB 12189		
		MB 12189		
	 Cover screw	MR 28005EU		
MR 28036EU				
 Mounting screw	MR 28036EU			
	MR 28036EU			
 Cover screw set, incl. 2 x MR 28005 EU and 2 x MR 28036	MRS 38036			
	MRS 38036			
 Cover screw set, incl. 4 x MR 28005 EU and 4 x MR 28036	MRS 38005			
	MRS 38005			



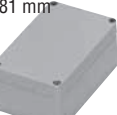
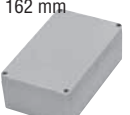
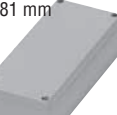
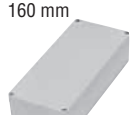







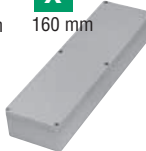

# FIBOX EURONORD II

FIBOX EURONORD II ALUMINIUM IP66 / IP67, IK 08		Z X C			FIBOX EURONORD II ALUMINIUM IP66 / IP67, IK 08		Z X C		
		B X A	ORDER SYMBOL				B X A	ORDER SYMBOL	
		L X S mm					L X S mm		
AL 050503 Y X X 50 mm 45 mm 	Z / C 31.5 x 20.5 B x A - L x S 40 x 35		AL 050503		AL 082506 Y X X 252 mm 81 mm 	Z / C 56.5 x 45.5 B x A 231 x 39 L x S 238 x 52		AL 082506	
AL 060605 Y X X 60 mm 66 mm 	Z / C 46 x 35 B x A 46 L x S 46 x 36		AL 060605		AL 121208 Y X X 125 mm 124 mm 	Z / C 81 x 64 B x A 95 x 52 L x S 104,6 x 82		AL 121208	
AL 061005 Y X X 100 mm 66 mm 	Z / C 46 x 35 B x A 45 x 50 L x S 86 x 36		AL 061005		AL 122208 Y X X 222 mm 125 mm 	Z / C 81 x 64 B x A 193 x 52 L x S 202,6 x 82		AL 122208	
AL 061505 Y X X 152 mm 66 mm 	Z / C 46 x 35 B x A 100 x 46 L x S 138 x 36		AL 061505		AL 123608 Y X X 362 mm 125 mm 	Z / C 81 x 64 B x A 333 x 52 L x S 342,6 x 82		AL 123608	
AL 080806 Y X X 82 mm 77 mm 	Z / C 56.5 x 45.5 B x A 56 x 39 L x S 63 x 52		AL 080806		AL 161609 Y X X 163 mm 162 mm 	Z / C 91 x 74 B x A 130 x 76 L x S 140 x 110		AL 161609	
AL 081306 Y X X 127 mm 81 mm 	Z / C 56.5 x 45.5 B x A 50 x 62 L x S 113 x 52		AL 081306		AL 162609 Y X X 263 mm 162 mm 	Z / C 91 x 74 B x A 230 x 76 L x S 240 x 110		AL 162609	
AL 081806 Y X X 177 mm 81 mm 	Z / C 56.5 x 45.5 B x A 100 x 62 L x S 163 x 52		AL 081806		AL 163609 Y X X 360 mm 160 mm 	Z / C 90 x 72 B x A 330 x 76 L x S 340 x 110		AL 163609	

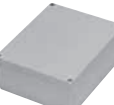
External height **Y** External width **X** External depth **Z** Free internal mounting height **C** Mounting plate assembly **B X A** Wall mounting **L X S**



# FIBOX EURONORD II

FIBOX EURONORD II ALUMINIUM IP66 / IP67, IK 08		Z x C	B x A	L x S mm	ORDER SYMBOL	FIBOX EURONORD II ALUMINIUM IP66 / IP67, IK 08		Z x C	B x A	L x S mm	ORDER SYMBOL
AL 165609 Y x X 560 mm 160 mm 	Z x C 90 x 72 B x A 530 x 76 L x S 540 x 110	AL 165609				AL 236011 Y x X 600 mm 230 mm 	Z x C 110 x 90 B x A 570 x 144 L x S 580 x 180	AL 236011			
AL 232011 Y x X 230 mm 200 mm 	Z x C 110 x 93 B x A 144 x 170 L x S 180 x 180	AL 232011				AL 314011 Y x X 402 mm 310 mm 	Z x C 110 x 90 B x A 372.5 x 223.5 L x S 382.5 x 261	AL 314011			
AL 232018 Y x X 230 mm 200 mm 	Z x C 180 x 162 B x A 144 x 170 L x S 180 x 180	AL 232018				AL 314018 Y x X 402 mm 310 mm 	Z x C 180 x 162 B x A 372.5 x 223.5 L x S 382.5 x 261	AL 314018			
AL 232811 Y x X 280 mm 230 mm 	Z x C 110 x 93 B x A 250 x 144 L x S 260 x 180	AL 232811				AL 316011 Y x X 600 mm 310 mm 	Z x C 110 x 92 B x A 570 x 223.5 L x S 580 x 261	AL 316011			
AL 233311 Y x X 330 mm 230 mm 	Z x C 110 x 93 B x A 300 x 144 L x S 310 x 180	AL 233311				AL 316018 Y x X 600 mm 310 mm 	Z x C 180 x 162 B x A 570 x 223.5 L x S 580 x 261	AL 316018			
AL 233318 Y x X 330 mm 230 mm 	Z x C 180 x 162 B x A 300 x 144 L x S 310 x 180	AL 233318									
AL 234011 Y x X 401 mm 230 mm 	Z x C 110 x 92 B x A 373 x 144 L x S 381 x 180	AL 234011									

External height **Y** External width **X** External depth **Z** Free internal mounting height **C** Mounting plate assembly **B** x **A** Wall mounting **L** x **S**

**FIBOX EURONORD**





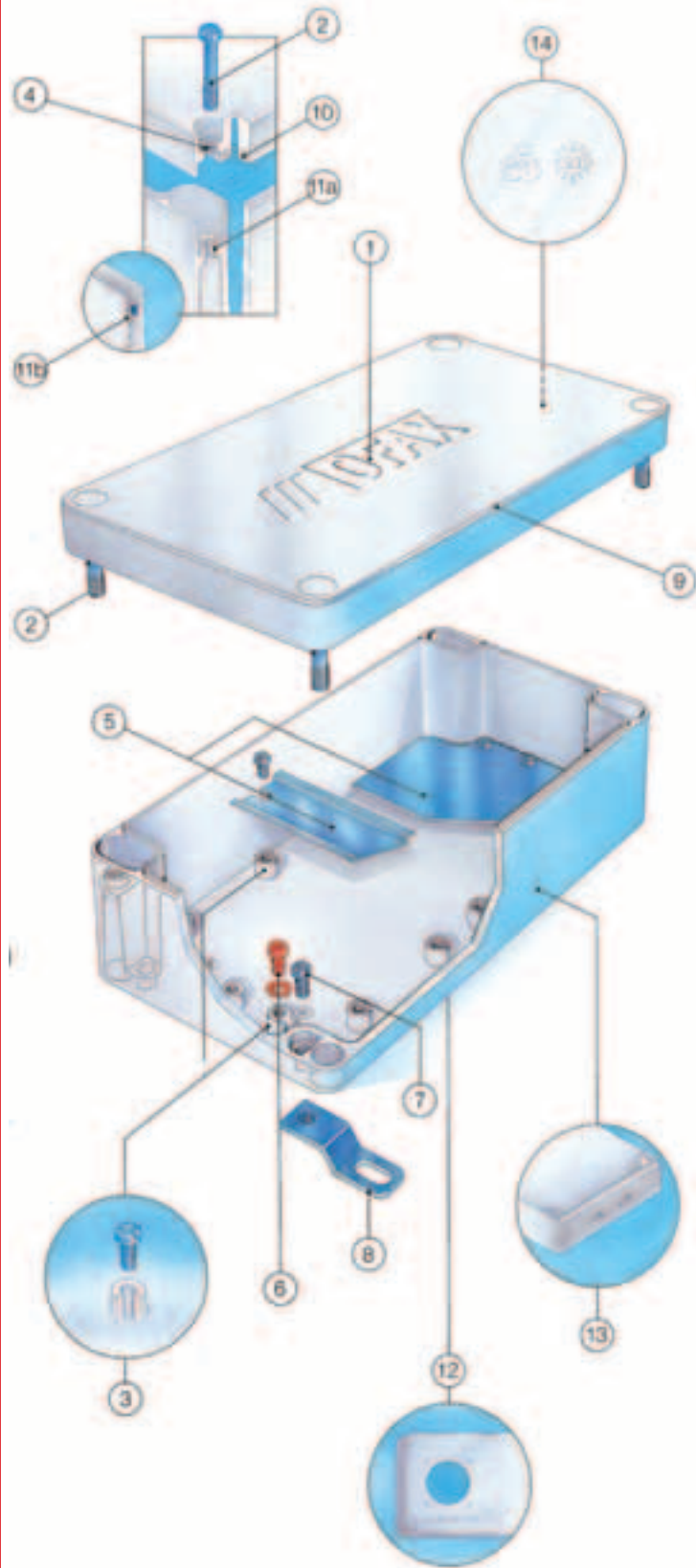







## FIBOX EURONORD II

### ALUMINIUM ENCLOSURES



1. Enclosure covers can be custom designed. Modifications include holes, cutouts, flanges, and frames. Even external changes such as cooling ribs (heat sinks) are possible. OEMs receive the enclosure ready for assembly.
2. Cover screws are designed for automatic assembly using normal tools or PosiDrive Phillips screwdrivers. Slightly ferrite, FI stainless screws work with magnetised drivers.
3. This enclosure has more internal mounting points than other enclosures on the market. There are threaded M4 or M6 mounting pods at both interior ends of the bases. Along the interior sides, the enclosure bases have rows of pods ready for M3 Taptite (smaller enclosures) and M5 Taptite (larger enclosures). Alternatively, pods can be machined for M4 or M5 mounting screws. Helicoil inserts are available in English thread sizes.  
  
The large number of mounting pods, especially in the bigger enclosures, creates many alternatives for mounting components. Various sized mounting plates are easily installed. DIN rails can be mounted either vertically or horizontally permitting high density terminal block installation.  
  
Usable internal depth is maximised as Euronorm II has the lowest height mounting pods on the market.
4. A special retainer keeps cover screws captive. No more lost hardware.
5. A variety of mounting plate sizes are available, plus TS35 and TS15 DIN rail cut to size.
6. Proper electrical earthing is ensured with copper plated screws and paint free grounding pods.
7. The enclosures can be mounted through the base. The mounting holes are outside the gasket area; maintaining the water tight seal. Oval shaped mounting holes accommodate mounting centre variations.
8. Optional stainless steel wall mounting plates permit mounting without opening the enclosure.
9. The Euronorm II features a slightly bevelled edge design creating a modern look.
10. Robotically applied, foamed in place PUR gaskets are into the unique designed gasket groove. The tight adhesion and low compression set of PUR gasket material insures protection ratings of NEMA 4 and IP 66/67.
11. Enclosure bases are tapped to receive cover screws, either M4 or M6, depending upon enclosure size. Optional special thread types are available, as are Helicoil special steel thread inserts which prevent cover screws from corroding even in saltwater environments.
12. Customisation of the back and sides of the enclosure can be supplied by Fibox.
13. Larger enclosures have lots of space for mounting instruments, switches, sensors, indicators and connectors. Smooth sides permit easy machining and allow decal and screen printing. Fibox can customise the enclosure with openings, cut-outs, holes and tapped holes. Changes can add unique options, for example, conduit hub openings or cooling fins.
14. Manufactured using unique techniques. These enclosures have straight sides (no draft angle) which means conduit and cable fitting are at right angles, insuring stress free connections. Further, straight sides mean that enclosures can be securely "ganged" together without gaps.

# FIBOX EURONORD II

FIBOX EURONORD II POLYESTER (GRP) IP65, IK 08		Z x C	B x A	L x S mm	ORDER SYMBOL	FIBOX EURONORD II POLYESTER (GRP) IP65, IK 08		Z x C	B x A	L x S mm	ORDER SYMBOL
P 080806		Z x C 55 x 47 B 59 L x S 68 x 45			P 080806	P 162609		Z x C 92 x 75 B x A 233 x 76 L x S 240 x 110			P 162609
P 081106		Z x C 55 x 47 B 89 L x S 98 x 45			P 081106	P 163609		Z x C 91 x 74.5 B x A 333 x 76 L x S 340 x 110			P 163609
P 081606		Z x C 55 x 47 B 139 L x S 148 x 45			P 081606	P 252612		Z x C 121 x 105 B x A 227.5 x 100 L x S 236 x 200.5			P 252612
P 081906		Z x C 55 x 47 B 169 L x S 178 x 45			P 081906	P 254012		Z x C 120 x 104.5 B x A 372.5 x 100 L x S 381.5 x 201			P 254012
P 121209		Z x C 90 x 75 B x A 95 x 52 L x S 106 x 82			P 121209	P 404012		Z x C 120 x 105 B x A 373.5 x 250.5 L x S 381.5 x 356			P 404012
P 122209		Z x C 90 x 75 B x A 193 x 52 L x S 204 x 82			P 122209						
P 161609		Z x C 91 x 75 B x A 132 x 76 L x S 140 x 110			P 161609						

External height **Y** External width **X** External depth **Z** Free internal mounting height **C** Mounting plate assembly **B** x **A** Wall mounting **L** x **S**

**FIBOX EURONORD**

# FIBOX EURONORD II



## TECHNICAL INFORMATION FOR EURONORD ALUMINIUM- AND POLYESTER ENCLOSURES

PROPERTY	AISI Cast ALUMINIUM	CONFORMITY TO STANDARDS (UL, CSA, CE, Lloyds, BV, FI)
Ingress Protection (EN 60529)	IP66/67	<b>USA</b> Enclosures for Electrical Equipment UL Type 1, 4, 4X, 6, 12 and 13 (50/508)
Impact Resistance (EN 50102)	IK 08	<b>Canada</b> Industrial Control Equipment Enclosures for Electrical Equipment/ULc
Temperature Range (short term) Celsius	-50° .. 140°C	<b>Europe</b> Safety of Information Technology Equipment EN 60950
Temperature Range (short term) Fahrenheit	-60° .. 285°F	
Temperature Range (continuous) Celsius	-50° .. 80°C	
Temperature Range (continuous) Fahrenheit	-60° .. 175°F	
Polyester Powder Paint Colour	RAL 7001	
Cover Screws	Stainless Steel	
Gasket	PUR/Neoprene	
Chemical Resistance *	Good	

PROPERTY	FIBERGLASS	CONFORMITY TO STANDARDS (UL, CSA, CE, Lloyds, BV, FI)
Ingress Protection (EN 60529)	IP65	<b>USA</b> Enclosures for Electrical Equipment NEMA 1, 4, 4X, 6, 12 and 13
Impact Resistance (EN 50102)	IK 08	<b>Canada</b> Industrial Control Equipment Enclosures for Electrical Equipment/ULc
Temperature Range (short term) Celsius	-50° .. 120°C	<b>Europe</b> Safety of Information Technology Equipment EN 60950
Temperature Range (short term) Fahrenheit	-60° .. 250°F	
Temperature Range (continuous) Celsius	-40° .. 80°C	<b>Australia</b> Enclosures for switch gear and control gear
Temperature Range (continuous) Fahrenheit	-40° .. 175°F	AS 3132-1991
Electrical Insulation	Totally insulated <input type="checkbox"/>	UL 746 C 5 in. vertical flame test
Colour	RAL 7001, grey	IEC 695-2-1, Self-extinguishing
Enclosure Flammability Rating	UL94-5V	
Glow Wire test	960°C	
Cover Screws	Stainless Steel	
Gasket	EPDM	
Chemical Resistance *	Good	

Data subject to change without notice. \*Consult separate raw material data for more detailed information

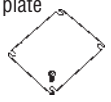
## ACCESSORIES FOR EURONORD ALUMINIUM ENCLOSURES

Product	Order symbol	Size mm	
 Mounting plate	AM 0808	69 x 64	
	AM 0813	69 x 114	
	AM 0818	69 x 164	
	AM 0825	69 x 240	
	AM 1212	107 x 110	
	AM 1222	107 x 207	
	AM 1236	107 x 347	
	AM 1616	146 x 146	
	AM 1626	146 x 244	
	AM 1636	146 x 346	
	AM 1656	146 x 545	
	AM 2320	215 x 184	
	AM 2328	215 x 264	
	AM 2333	215 x 315	
	AM 2340	215 x 385	
	AM 2360	215 x 586	
	AM 3140	294 x 387	
AM 3160	293 x 585		
 Mounting rail DIN 15	ARM 0610	15 x 88	
	ARM 0615	15 x 140	
	ARM 0808	15 x 65	
	ARM 0813	15 x 115	
	ARM 0818	15 x 165	
	ARM 0825	15 x 240	
 Mounting rail DIN 35	ARH 12	35 x 105	
	ARH 22	35 x 203	
	ARH 36	35 x 343	
	ARH 16	35 x 140	
	ARH 26	35 x 240	
	ARH 1636	35 x 340	
	ARH 1656	35 x 540	
	ARH 2320	35 x 180	
	ARH 2328	35 x 260	
	ARH 2333	35 x 310	
	ARH 40	35 x 383	
	ARH 60	35 x 580	
	Earth screw	MR 28550M	M4 x 6
Earth screw	MR 28546CU	M4 x 6	
Mounting screw Screw set	MR 28548ZN	M4 x 6	
	MRS 38546		
Ground screw	MR 28547CU	M6 x 8	

Product	Order symbol	Size mm	
Mounting screw Screw set	MR 28549ZN		
	MRS 38547		
Cover screw	MR 10425	M4 x 20	
	MR 10635	M6 x 30	
Mounting foot kit	MRS 28540	11 x 42	
	MRS 28541	15 x 50	
 Mounting screw	MR 28550	M4 x 6	
	MR 28546CU	M4 x 6	
	MR 28548ZN		
	MRS 38546		
	MR 28547CU	M6 x 8	
	MR 28549ZN	M6 x 8	
	MRS 38547		
	MR 75003	M3	
	MR 75005	M5	
	MRHC 406	M4	
MRHC 609	M6		
Cover screw	MRS 28544A4	M6 x 30	
	MRS 28545WH	M6 x 30	

## ACCESSORIES FOR EURONORD POLYESTER

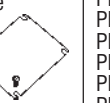
Product	Order symbol	Size mm	
 Mounting plate	PM 0808	64 x 69	
	PM 0811	64 x 99	
	PM 0816	64 x 149	
	PM 0819	64 x 179	
	PM 1616	146 x 146	
	PM 1626	146 x 244	
	PM 2526	231 x 240	
	PM 2540	231 x 383	
	PM 4040	390 x 385	
	Mounting rail DIN 15	PRM 0811	15 x 99
PRM 0816		15 x 149	
PRM 0819		15 x 179	
Mounting rail DIN 35	PRH 2526	35 x 238	
Hinge kit 1 pair includes screws	AH A/B		
	PH A		
Mounting lug kit	MRS 28540	11x42	
	MRS 28541	15x50	

# FIBOX

MCE

MCE CONTROL, MCE FEM, MCE ISO



- MCE CONTROL
- MCE FEM
- MCE ISO

The FIBOX MCE modular component enclosures offer a practical and modern design to automation, control and switch gear applications from IP 55 (MCE FEM and MCE ISO) to IP 65 (MCE CONTROL). In MCE CONTROL and MCE FEM unique features include multiple membrane cable glands (Multi-FEM).

In larger (14+) sizes a variety of flange plates is available for the standard size 2 knock-out. All cable entry knock-outs in Fibox MCE are in metric dimensions to reflect modern trends. Application specific wiring can be achieved from any direction, easily, quickly and securely.









# FIBOX MCE CONTROL

FIBOX MCE CONTROL Polycarbonate: IP 65, IK 08		L x S mm	Including: Multi-FEM (one for 5 and 9, two for 14 and three for 28 and 42), FEM 10-14/25 and/or FEM 14-20 membrane cable glands, two PEN 10mm <sup>2</sup> bars in plastic support, DIN 35 rail pre-mounted, wall mount cover plugs, module marking stripe and -pocket, mounting instructions.	ORDER SYMBOL	Endplates
MCE PC 5 Y x X x Z 200 mm x 116 mm x 105 mm	5			L/S 155/60	MCE PC 5 MF/M
MCE PC 9 Y x X x Z 200 mm x 190 mm x 105 mm	9	L/S 155/120	MCE PC 9 MF/M	MCE 9 MF 	MCE 9 M 
MCE PC 14 Y x X x Z 280 mm x 306 mm x 145 mm	14	L/S 236/220	MCE PC 14 MF/FL MCE PC 14 MF/M	MCE 14 FL (for sizes 14, 28 and 42) 	MCE 14 M (for sizes 14, 28 and 42) 
MCE PC 28 Y x X x Z 430 mm x 306 mm x 145 mm	28	L/S 386/220	MCE PC 28 MF/FL MCE PC 28 MF/M	MCE 14 MF (for sizes 14, 28 and 42) 	
MCE PC 42 Y x X x Z 580 mm x 306 mm x 145 mm	42	L/S 536/220	MCE PC 42 MF/FL MCE PC 42 MF/M		

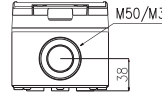
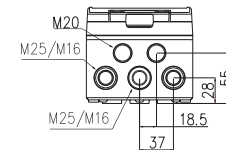
External height **Y**    External width **X**    External depth **Z**    Wall mounting trough the base **L x S**

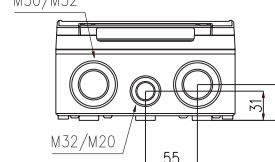
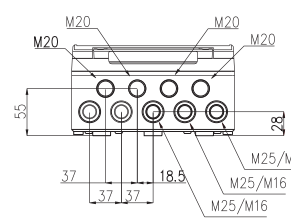
# FIBOX MCE FEM

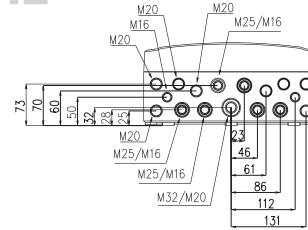
## FIBOX MCE FEM

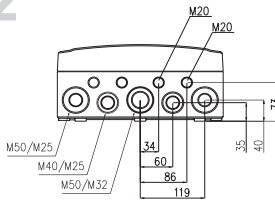
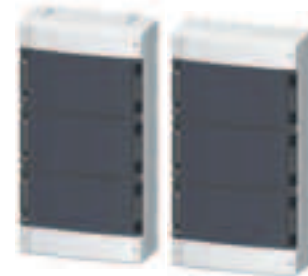
FIBOX MCE FEM Polystyrene: IP 55, IK 07		L x S mm	ORDER SYMBOL	Endplates
<b>MCE FEM 5</b> Y x X x Z 200 mm x 116 mm x 105 mm 	5	L/S 155/60	MCE FEM 5 MF/M	<b>MCE 5 MF</b> 
				<b>MCE 5 M</b> 
<b>MCE FEM 9</b> Y x X x Z 200 mm x 190 mm x 105 mm 	9	L/S 155/120	MCE FEM 9 MF/M	<b>MCE 9 MF</b> 
				<b>MCE 9 M</b> 
<b>MCE FEM 14</b> Y x X x Z 280 mm x 306 mm x 145 mm 	14	L/S 236/220	MCE FEM 14 MF/FL MCE FEM 14 MF/M	<b>MCE 14 FL (for sizes 14, 28 and 42)</b> 
				<b>MCE 14 M (for sizes 14, 28 and 42)</b> 
<b>MCE FEM 28</b> Y x X x Z 430 mm x 306 mm x 145 mm 	28	L/S 386/220	MCE FEM 28 MF/FL MCE FEM 28 MF/M	<b>MCE 14 MF (for sizes 14, 28 and 42)</b> 
<b>MCE FEM 42</b> Y x X x Z 580 mm x 306 mm x 145 mm 	42	L/S 536/220	MCE FEM 42 MF/FL MCE FEM 42 MF/M	

External height **Y**    External width **X**    External depth **Z**    Wall mounting trough the base **L** **X** **S**

Including: Multi-FEM (one for 5 and 9, two for 14 and three for 28 and 42), FEM 10-14/25 and/or FEM 14-20 membrane cable glands, two PEN 10mm<sup>2</sup> bars in plastic support, DIN 35 rail pre-mounted, wall mount cover plugs, module marking stripe and -pocket, mounting instructions.

# FIBOX MCE ISO

FIBOX MCE ISO Polystyrene: IP 55, IK 07		Including: Modular component enclosure with TPE gaskets, mounted DIN 35-rail, wall mount cover plugs and mounting instructions.		
L x S mm		ORDER SYMBOL		Endplates
<b>MCE ISO 5</b> <b>Y</b> x <b>X</b> x <b>Z</b> 200 mm x 116 mm x 105 mm 	<b>5</b> L/S 155/60	MCE ISO 5 P/P		<b>MCE 5 P</b> <b>5</b> 
<b>MCE ISO 9</b> <b>Y</b> x <b>X</b> x <b>Z</b> 200 mm x 190 mm x 105 mm 	<b>9</b> L/S 155/120	MCE ISO 9 P/P		<b>MCE 9 P</b> <b>9</b> 
<b>MCE ISO 14</b> <b>Y</b> x <b>X</b> x <b>Z</b> 280 mm x 306 mm x 145 mm 	<b>14</b> L/S 236/220	MCE ISO 14 P/P		<b>MCE 14 P</b> <b>14</b> 
<b>MCE ISO 28</b> <b>Y</b> x <b>X</b> x <b>Z</b> 430 mm x 306 mm x 145 mm 	<b>28</b> L/S 386/220	MCE ISO 28 P/P		<b>MCE 28 P</b> <b>28</b> 
<b>MCE ISO 42</b> <b>Y</b> x <b>X</b> x <b>Z</b> 580 mm x 306 mm x 145 mm 	<b>42</b> L/S 536/220	MCE ISO 42 P/P		<b>MCE 42 P</b> <b>42</b> 

External height **Y** External width **X** External depth **Z** Wall mounting trough the base **L** x **S**

# FIBOX MCE

## SYMBOLS AND ABBREVIATIONS

- Y** External height
- X** External width
- Z** External depth
- L** Wall mounting trough the base
- S** Wall mounting trough the base

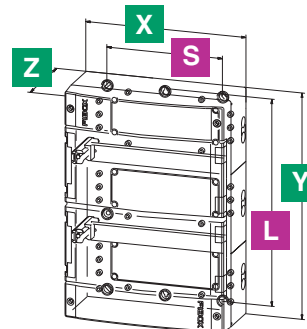

## ASSEMBLY HEIGHTS

Dimensions for sizes 5 and 9

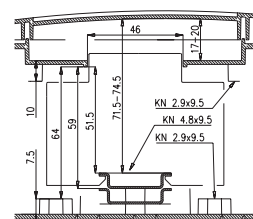

Dimensions for sizes 14, 28 and 42

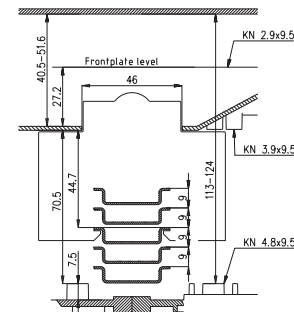

## TECHNICAL INFORMATION FOR MCE CONTROL

PROPERTY	POLYCARBONATE (PC)	CONFORMITY TO STANDARDS
Ingress Protection (EN 60529)	IP 65	<b>Europe</b> Enclosures for Switch Gear and Control Gear Assemblies EN 50298:1998
Impact Resistance (EN 50102)	IK 08	<b>Europe</b> Safety of Information Technology Equipment EN 60950
Temperature Range (short term)	Celsius: -40°-120°C Fahrenheit: -40°-250°F	<b>Australia</b> Enclosures for switch gear and control gear AS 3132-1991
Temperature Range (continuous)	Celsius: -40°-80°C Fahrenheit: -40°-175°F	
Insulation	Totally insulated <input type="checkbox"/>	
Light Grey Parts Colour	RAL 7035	
Transparent PC Cover	Industry Grey	
Cover Screws	Smoked Grey	
Gasket	Grey, Polyamide (PA)	
Enclosure Flammability Rating	TPE Thermo Plastic Elastomer	
Glow Wire Test	UL-94 5V	UL 746 C 5 in. Vertical flame test
Non-toxicity	960°C	IEC 695-2-1, Self-extinguishing
UV resistance	Halogen Free	DIN/VDE 0472, Part 815
Chemical Resistance *	UL 508	
	720 hours in "Weatherometer"	
	Good	

## TECHNICAL INFORMATION FOR MCE FEM AND MCE ISO

PROPERTY	VALUE
Ingress Protection (EN 60529)	IP 55
Impact Resistance (EN 50102)	IK 07
Temperature Range (short term)	-40°...80°C
Temperature Range (continuous)	-40°...60°C
Electrical Insulation	Totally insulated <input type="checkbox"/>
Light Industry Grey Parts Colour	RAL 7035
Transparent PC Cover	Smoked Grey
Cover Screws, Polyamide (PA)	Grey
Gasket	TPE
Material Flammability Rating	UL-94HB
Glow Wire Test (IEC 695-2-1)	750°C
Glow Wire Test/Current carrying parts	960°C
Non-toxicity (DIN/VDE 0472, Part 815)	Halogen Free
Chemical Resistance *	Good

Data subject to change without notice. \*Consult separate raw material data for more detailed information

## FIBOX MCE CONTROL PC / FEM / ISO

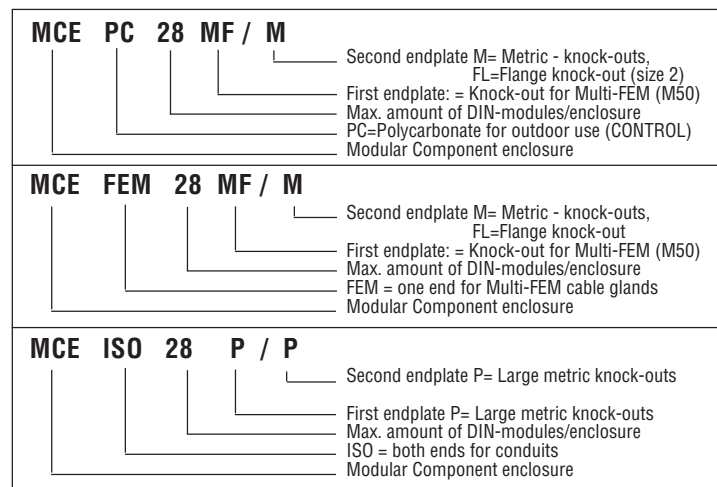

## WHY POLYCARBONATE (PC)?

Polycarbonate, trade names Lexan, Makrolon etc., is known as high tech engineering thermoplastic with high levels of mechanical, optical, electrical and thermal properties. But why are Fibox Polycarbonate types so well suited for enclosures in power distribution applications?



### It can be used outdoors

Polycarbonates FIBOX use are all UV tested for outdoor use, are highly corrosion resistant and make enclosures IP 65 (EN 60529 4:1992) weather resistant. One quality of enclosure for all environments.



### It is safe in fire

Polycarbonates FIBOX use are 960 (C glow wire (IEC 695-2-1) and UL 94 V-0 tested. Self-extinguishing, non-igniting with no potentially hazardous halogen additives.



### It does not break

Hard knocks and rough handling pose no problems. Polycarbonates that Fibox uses insure that our enclosures meet IK 08 (EN 50102) or better impact resistance.

Interested in more information? Order Fibox "The Future is Plastic" information sheet.

MCE CONTROL, MCE FEM, MCE ISO

# FIBOX

## MCE CONTROL

### SPACIOUS AND EASY TO WIRE

PEN supports are positioned to allow optimum wiring space inside the enclosure. Their position also makes wiring as easy as possible. DIN rails are mounted away from the base of the enclosure and on units of 14+ modules the position is adjustable. Large knockouts are provided in the base of the enclosure to accommodate the entry of flush wiring.

### EVERY WIRING CONFIGURATION MADE POSSIBLE

"MULTI FEM", multi-cable membrane glands, size M50, enable quick and effective entry of 3 x Ø 6-10 mm, 3 x Ø 10-14 mm through one single membrane while maintaining IP65. In sizes for 14 modules and above many gland plate options are available including blind, metric, PG, threaded, NPT and membrane versions. There are cable entries on five sides of every MCE enclosure and all of them are to the metric standard.

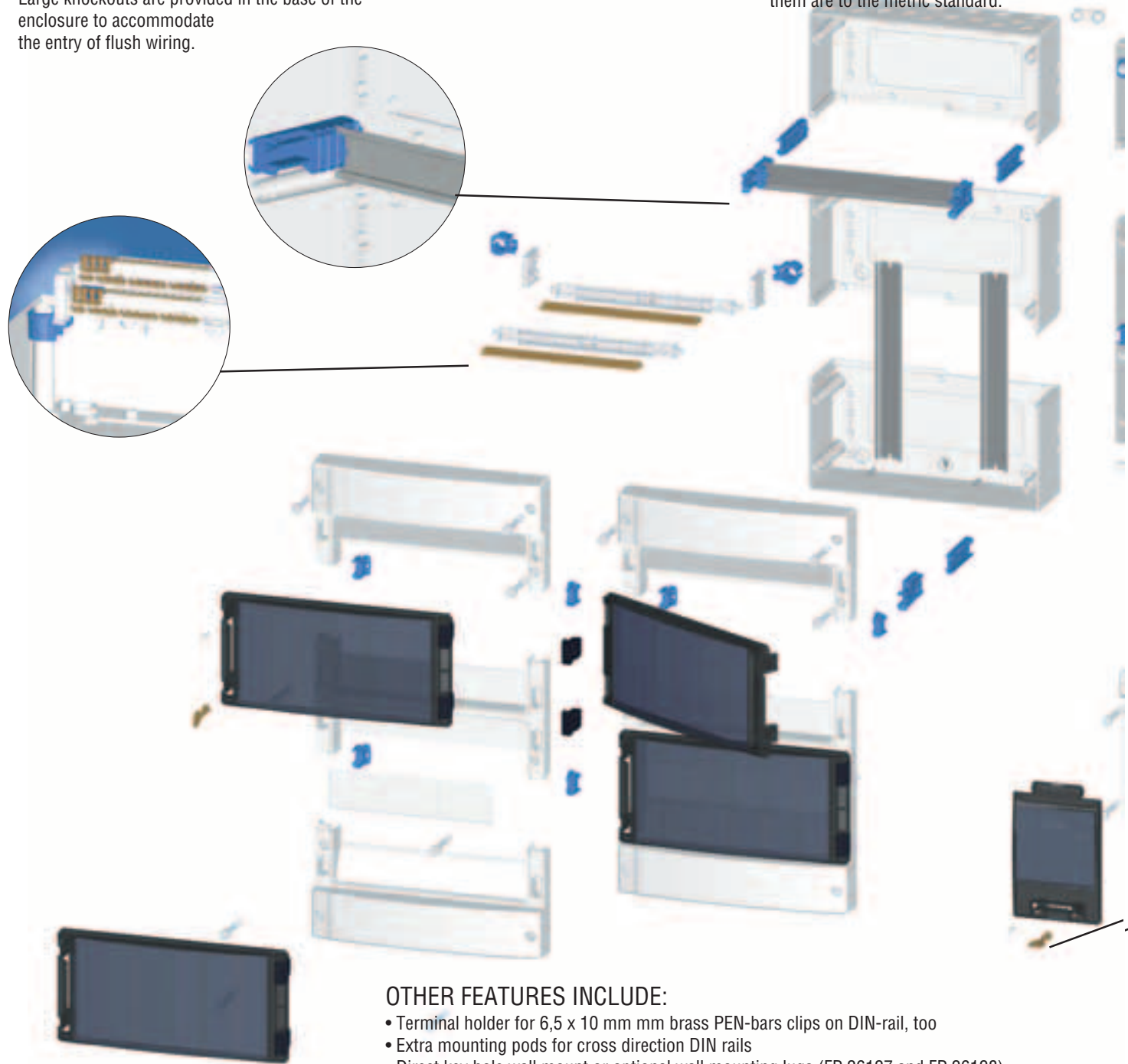









### OTHER FEATURES INCLUDE:

- Terminal holder for 6,5 x 10 mm mm brass PEN-bars clips on DIN-rail, too
- Extra mounting pods for cross direction DIN rails
- Direct key hole wall mount or optional wall mounting lugs (FP 26127 and FP 26128)
- Size 2/FL 21 knock-out for standard gland plates
- Front aperture can be covered with plates (mounting screw holes provided)
- Window can be replaced with instrumentation cover (14+ sizes)
- Enclosures can be connected to each other in all four directions due to the smooth sides and M20 knock-outs
- Enclosure can be mounted directly on flush mounted junction boxes via purpose designed knock-outs in the bottom of the enclosure

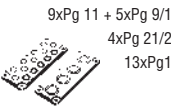

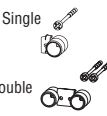

ACCESSORIES FOR FIBOX MCE CONTROL AND FEM

Product	Order symbol	Size mm	EAN-code
<b>Multi-FEM</b> Multi-FEM membrane cable glands allow entry of several cables through one gland. IP 65. 	MFM 8-12	M50	
<b>Membrane cable glands</b> Easy and fast assembly, security, high protection rating (IP 65) and cable strain relief are standard features. 	FEM 3-5 FEM 5-7 FEM 7-10 FEM 10-14/23 FEM 10-14/25 FEM 14-20 FEM 20-26 FEM 26-35 FEM 30-45	M12 M16 M20 M23/PG16 M25 M32 M40 M50 M60	
<b>Membrane flange plates</b> Time and space saving membrane flange plates are made of light grey EPDM rubber. They offer up to three times the capacity of a traditional cable gland. 	FMB 5 FMC 3 FMC 25 FMC 35	Flange  size 2 (EK) size 2 (EK)	
<b>Flange plate (PC)</b> Cover plate (Metric) knockout plate, 4xM12 + 4xM12/M20 + 4xM16/M25 Glass fibre reinforced polycarbonate flange plates are completely halogen free. EPDM-gaskets ensure high IP 67 protection rating. Smooth cover plate provides easy and safe machining.	MB 10546 MB 10857	Flange size 2 (EK) size 2 (EK)	
<b>Knock-out plate (PC)</b> These PG-knock-out plates feature the same material properties, and strength as MB 10546 and MB 10857. 	9xPg 11 + 5xPg 9/16 4xPg 21/29 13xPg16	MB 10593 MB 10594 MB 10595	Flange size 2 (EK) size 2 (EK) size 2 (EK)
<b>Key lock set</b> One key lock set includes two keys. No mounting required: simply insert the lock with the key, turn clockwise and remove the key. To unlock just reverse the procedure. 	MR 26065		
<b>Wall fastening lug</b> FIBOX MCE enclosures can be mounted to wall or rails either through the base of the enclosure or with wall fastening lugs. Single lug allows fastening of an enclosure without piercing the base. Double lug can be used for wallmounting of a single enclosure or for conjunction of two enclosures. 	Single Double	FP 26128  FP 26127	
<b>PEN bus-bar holder</b> for MCE 5 for MCE 9 for MCE 14-42		PEN H 26135 PEN H 26136 PEN H 26140	
<b>Multiadapter for PEN-bars</b> 	MU 26138		
<b>PEN-bar Earth/neutral terminal busbar</b> 	6x10 mm <sup>2</sup> 10x10 mm <sup>2</sup> 16x10 mm <sup>2</sup> 35x10 mm <sup>2</sup>	PEN 6x10 PEN 10x10 PEN 16x10 PEN 35x10	
<b>Marking stripe for MCE 5</b> Marking stripe pocket for MCE 5 Marking stripe for MCE 9 Marking stripe pocket for MCE 9 Marking stripe for MCE 14+ Marking stripe pocket for MCE 14+		MB 26061 MB 26062 MB 26063 MB 26064 MB 26065 MB 26066	
<b>Cover Stripe</b>	MB 26050		

MCE CONTROL, MCE FEM



UNAUTHORISED ACCESS STOPS HERE

Stylish, but impact proof window can be secured easily with a clasp, MR 26065 key lock (optional) or screw. Pad lock set MR 26146 SET for three MCE 14+ windows is also available. Secured windows cover the screws used for the mounting of frame part of the enclosure and thus the components and the wall mountings remain inaccessible. Cover screws and windows can be wire sealed, too.

## MODULAR SERVICES FOR YOUR BEST

Fibox introduces surface mounting aid and multitude of earth-neutral solutions for all MCE sizes and a pad locking system for MCE 14+ sizes. All these products affirm the modularity of MCE enclosures and emphasise the characteristics of the range.

FIBOX MCE PE/N/PEN -bar -sets are complete packages, that include Phase Earth and Neutral bars and all necessary holders needed for assembly to FIBOX MCE enclosures. The same parts follow with standard delivery of MCE CONTROL and MCE FEM enclosures.

Note! All FIBOX MCE PE/N/PEN holders can also be mounted straight on DIN-rails. Then they take about one modular width, depending on the type of the wire used.

This feature together with well designed knock-outs on five sides of the MCE-enclosures enables the use of solitary enclosures even only for earthing purposes, whilst components are on neighbouring enclosures. Use of double wall fastening/conjunction lugs FP 26127 is useful on these occasions.

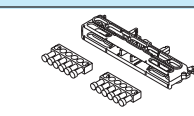
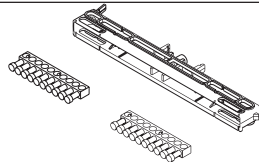
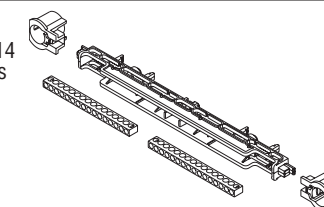
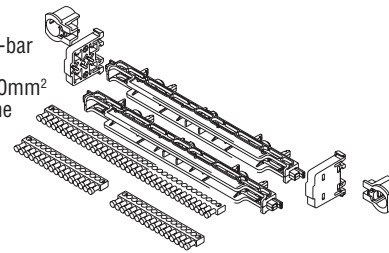
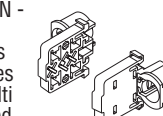
Product	Order symbol	
Ready to fit set includes PEN-bar holder for MCE 5 with two 6x10mm <sup>2</sup> brass bars.	MCE 5 PEN SET	
Ready to fit set includes PEN-bar holder for MCE 9 with two 10x10mm <sup>2</sup> brass bars.	MCE 9 PEN SET	
Ready to fit set includes PEN-bar holder for MCE 14 with two 16x10mm <sup>2</sup> brass bars.	MCE 14 PEN SET	
Ready to fit set includes two PEN-bar holders for MCE 14 with two 16x10mm <sup>2</sup> brass bars and one 35x10mm <sup>2</sup> brass bar and a multi adapter for easier mounting.	MCE 14 MU PEN SET	
Multi adapter set accepts a variety of PE/N/PEN -bars: brass or copper, profiles of 6,5x10mm (1 position in 4 placements), 5x5mm (2 positions in 3 placements), 2x12mm (12 placements). Naturally the MCE 14+ PE/N/PEN -bar holder fits into multi adapter. It can be mounted on DIN 35 -rail or to internal towers of MCE 14 and larger enclosures. Set includes a pair of tower mounting pieces and two multi adapters. PE/N/PEN -bars need to be acquired separately.	MCE MU PEN SET	
Terminal bus-bar clamp, 25 mm <sup>2</sup> .	MS BAR CLAMP	
Terminal bus-bar clamp, 35 mm <sup>2</sup> .	MR 26145	

## ALUMINUM FRONT PLATE FOR MCE 14+ ENCLOSURES

**FP A 26133** broadens the spectrum of control and measurement equipment that can be assembled into MCE 14 and larger enclosures. It is:

- rigid: Use for switches.
- even: ideal for membrane keypads
- flat: good for variety of displays
- light in weight, as all FIBOX MCEs
- easy to tool, as FIBOX MCE in the whole.
- easy to mount with just four screws.

(**KN 2.9x9.5**, please order separately, if applicable).

## SURFACE MOUNTING ON MCE 5 AND MCE 9 ENCLOSURES

Flat surface of the two smallest MCE enclosures allow mounting of displays, membrane keyboards, etc. directly under the window. To open the inner cover for modular components, please use screwdriver and hammer or a knife.

## PAD LOCKING SET FOR MCE 14+ ENCLOSURES

Pad locking set **MR 26146 SET**, which provides double locking safety for three MCE 14+ windows. Six 25mm x 25mm pad locks mounted into three holder parts keeps max. 42 modular components protected.

## WALL MOUNTING RAIL FOR MCE 14+ ENCLOSURES

Wall mounting rail set **FP AL 26148** contains two rails and mounting instructions. Rail is mounted horizontally to the back of the enclosure with two M5 12-14 mm screws. These holes on the rail are threaded. The wall mounting holes at the end of the rail are of 10 mm diameter. Please acquire the screws separately.

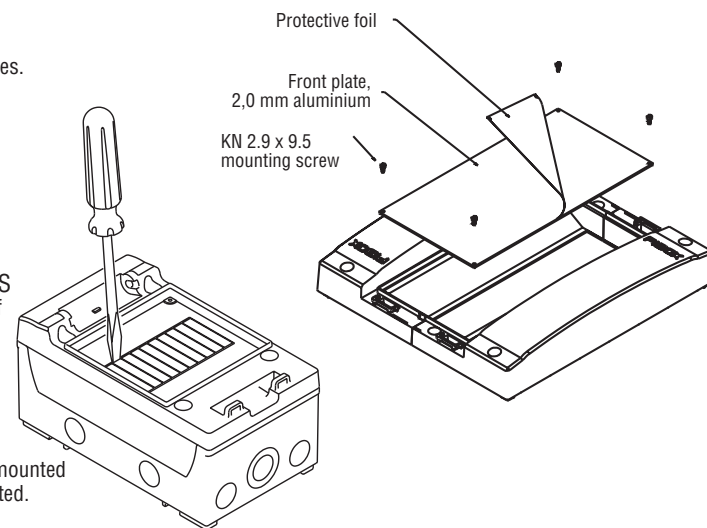

## FIBOX CUSTOMISATION SERVICES FOR MCE -ENCLOSURES

More than 30 years of know-how with injection moulded plastic enclosures has taught FIBOX few tricks of the trade. Therefore we are able to provide a comprehensive range of enclosure customising options in affordable price and short lead times. Machining and tooling can be done with experience and expertise. Customised moulding is also available for larger orders in very economical price. Printing or colouring can give your product the needed edge. And we are proud to offer it to you.

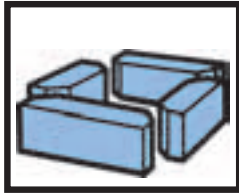

### FIBOX CUSTOMISATION SERVICES FOR MCE ENCLOSURES.

More than 30 years of know-how in injection moulding plastic enclosures has taught FIBOX a few tricks of the trade. Therefore we are able to provide a comprehensive range of affordable enclosure customizing options with short lead times. Machining is carried out by highly experienced personnel who know their jobs inside out. Economically priced customised moulding is also available on larger orders. Printing and special colours add the finishing touch to your customized product and give you a competitive edge.

#### CUSTOMISED TOOLING

Our customized tooling service offers you a low cost method of producing "tailor-made" enclosures to your own exact specification. The required investment is often minimal, especially when existing interchangeable tool slides can be utilized. A typical lead time using this option can be as short as 5 to 8 weeks. As an example, the end plates of Fibox MCE enclosures can be easily modified. This means the mount, shape and number of knock-outs can be changed. We can even provide no knock-outs at all.

The flexible modular design of the Fibox MCE range means that to achieve large scale customization it may be only necessary to modify a small number of tools, therefore keeping the expense aspects under control. In addition to physical modifications the colour of the enclosure can be customized by using colour pigmented plastic granules. In the case of a customized mould run the colour change represents only a nominal extra cost.

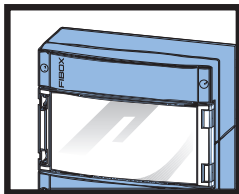

#### COLOURED PLASTIC ENCLOSURES

Fibox offers plastic enclosures in various customized RAL colours by using pre-coloured plastic raw material granules. The best result is achieved on non glass reinforced fibre materials. Colouring can be used as an efficient and relatively low cost method of promoting your company's corporate identity. This process becomes economical for batches of more than 500 pieces, then the surcharge is about 50%. For batches of 2000 pieces the surcharge is only about 10%. The additional cost involved when colouring enclosure raw material is incurred in cleaning and preparing moulds both before and after the production run. Painting of an MCE enclosure is not recommended due to the modular nature and design features.

As all Fibox MCE enclosures are constructed from various parts all these parts must be coloured separately. This allows for a variety of colour combinations. For example the cover screws, the enclosure body and the front frame can all be different colours. When designing a customized product it is important to remember that each coloured mould run increases the total enclosure price.

#### PRINTED ENCLOSURES

Silk screen printing and Tampo printing are recommended methods of adding logos, text or imagery to Fibox enclosures. Both methods can be used on flat surfaces and tampo printing is suitable for curved areas such as the cover. It is also recommended for areas where access is restricted, for example the area underneath the viewing window on Fibox MCE enclosures. Silk screen printing is an economical option for production batches of say 100, and Tampo printing is cost effective when the run is say 1000 pieces. Both methods, silk screen printing and Tampo printing, can accommodate one to three colours to RAL or PMS specifications. A quality end result is assured with both processes.

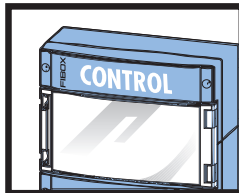

#### MACHINED ENCLOSURES

The Fibox machining service offers a peace of mind, value for money solution to your customizing requirement. Years of experience mean we can create the exact specification your drawings demand. Because we know our products and materials intimately we can advise you on the most efficient means of meeting your customizing needs quickly and efficiently. Fibox can machine enclosures to drawing with either metric or imperial dimensions. To attain a satisfactory result time and again we request that correct customizing drawings are provided. Our CAD/CAM system helps both Fibox and your designer to create drawings for CNC machining. Drawings of enclosures are available at [www.fibox.com](http://www.fibox.com) to be either printed out or copied c/w dimensions in PDF and GIF format or in DWG, IGES and DXF for downloading onto your CAD system for further modifications. Several enclosure drawings are also available in 3D format upon request.

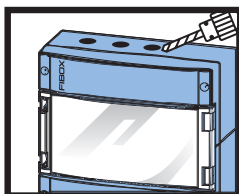

Although machining a standard Fibox MCE enclosure is possible, a better result will be achieved if totally smooth end plates are utilized at the outset. These options can be viewed in our range brochure – FIBOX MCE PANEL or by visiting [www.fibox.com](http://www.fibox.com).



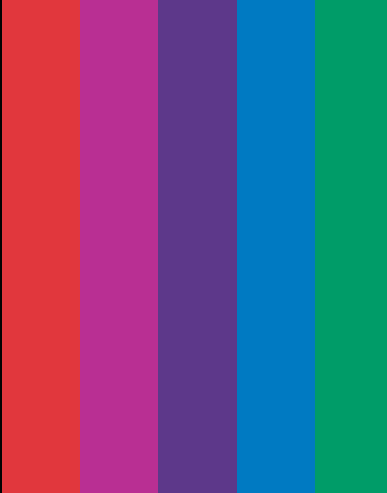

# FIBOX<sup>®</sup>

TESTED SYSTEMS

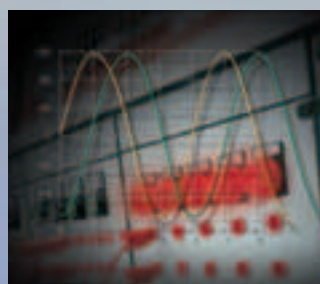

# FIBOX

SOLID

FIBOX SOLID



PC  
ABS  
SM  
HINGED COVER



FIBOX SOLID SC II



FIBOX SOLID METRIC KNOCK-OUTS





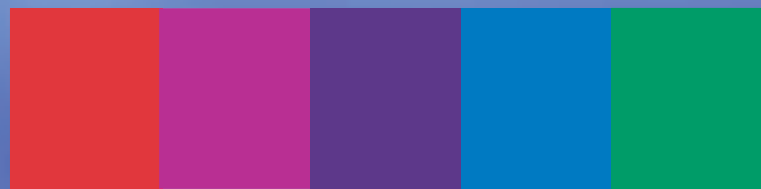

FIBOX SOLID HINGED COVER  
Cover with hinges, more information page 44.

The FIBOX SOLID SC II range, SM range and SOLID Hinged Cover range offer a clear alternative to polyester enclosures. Moulded with impact resistant polycarbonate or ABS plastic, the FIBOX SOLID range is available as a screw cover enclosure or as a hinged cover enclosure.  
The enclosures are rated EN 60529 IP66 / IP67.





# FIBOX SOLID

FIBOX SOLID PC: IP66 / IP67, IK 08 ABS: IP66 / IP67, IK 08	<b>Z</b> mm	<b>C</b> mm	Including: Enclosure base, 4 cross head cover screws, and mounting screws.		<b>B</b> x <b>A</b>  <b>L</b> x <b>S</b> mm
			ORDER SYMBOL	ORDER SYMBOL	
			Grey cover	Transparent cover	
PC 1919 ABS 1919 <b>Y</b> x <b>X</b> 190 mm 190 mm 	130	115	Cover 30 mm PC 1919 13 G	Cover 30 mm PC 1919 13 T	B x A 120 x 120
	130	115	Cover 80 mm PC 1919 18 G	Cover 80 mm PC 1919 18 T	L x S 164 x 164
PC 2819 ABS 2819 <b>Y</b> x <b>X</b> 280 mm 190 mm 	180	165	Cover 30 mm PC 2819 13 G	Cover 30 mm PC 2819 13 T	B x A 210 x 120
	180	165	Cover 80 mm PC 2819 18 G	Cover 80 mm PC 2819 18 T	L x S 254 x 164
PC 3819 ABS 3819 <b>Y</b> x <b>X</b> 380 mm 190 mm 	130	115	Cover 30 mm PC 3819 13 G	Cover 30 mm PC 3819 13 T	B x A 310 x 120
	130	115	Cover 80 mm PC 3819 18 G	Cover 80 mm PC 3819 18 T	L x S 354 x 164
PC 2828 ABS 2828 <b>Y</b> x <b>X</b> 280 mm 280 mm 	180	165	Cover 30 mm PC 2828 13 G	Cover 30 mm PC 2828 13 T	B x A 210 x 210
	180	165	Cover 80 mm PC 2828 18 G	Cover 80 mm PC 2828 18 T	L x S 254 x 254
PC 3828 ABS 3828 <b>Y</b> x <b>X</b> 380 mm 280 mm 	130	115	Cover 30 mm PC 3828 13 G	Cover 30 mm PC 3828 13 T	B x A 310 x 210
	130	115	Cover 80 mm PC 3828 18 G	Cover 80 mm PC 3828 18 T	L x S 354 x 254

External height **Y**    External width **X**    External depth **Z**    Free internal mounting height **C**    Mounting plate assembly **B** x **A**    Wall mounting **L** x **S**

# FIBOX SOLID

FIBOX SOLID

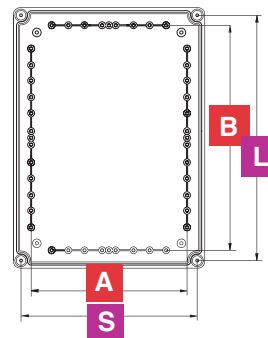
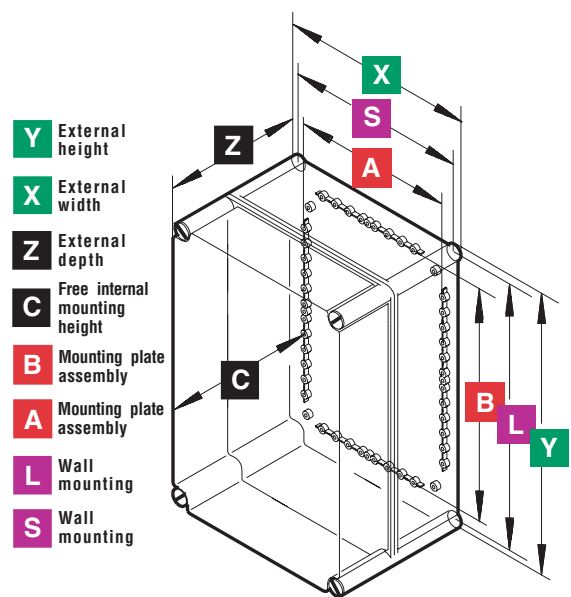



### SYMBOLS AND ABBREVIATIONS





PC 19 19 13 T

- └ Cover G= Grey  
T= Smoked grey
- └ Height
- └ Length
- └ Width
- └ Enclosure type

PC polycarbonate smooth sides  
 ABS ABS grey, smooth sides  
 SP polycarbonate with SM knock-outs

FIBOX SOLID PC: IP66 / IP67, IK 08 ABS: IP66 / IP67, IK 08	Z mm	C mm	Including: Enclosure base, 6 cross head cover screws, and mounting screws.		B x A L x S mm
			ORDER SYMBOL Grey cover	ORDER SYMBOL Transparent cover	
PC 5628 ABS 5628 Y x X 560 mm 280 mm 	130 130	115 115	Cover 30 mm PC 5628 13 G ABS 5628 13 G	Cover 30 mm PC 5628 13 T ABS 5628 13 T	B x A 489 x 210 L x S 534 x 254
PC 5638 ABS 5638 Y x X 560 mm 380 mm 	180 180	165 165	Cover 30 mm PC 5638 18 G ABS 5638 18 G	Cover 30 mm PC 5638 18 T ABS 5638 18 T	B x A 489 x 310 L x S 534 x 354





## FIBOX SOLID SM WITH METRIC KNOCK-OUTS

FIBOX SOLID SM PC: IP66 / IP67, IK 08 ABS: IP66 / IP67, IK 08	Z mm	C mm	Including: Enclosure base, 4 slotted cover screws, and mounting screws.		B X A L X S mm
			ORDER SYMBOL	ORDER SYMBOL	
			Grey cover	Transparent cover	
<b>SM 1928</b> <b>Y</b> x <b>X</b> 280 mm 190 mm 	130 180	115 165	SM 1928 13 G SM 1928 18 G	SM 1928 13 T SM 1928 18 T	B x A 210 x 120  L x S 254 x 164
<b>SM 2819</b> <b>Y</b> x <b>X</b> 190 mm 280 mm 	130 180	115 165	SM 2819 13 G SM 2819 18 G	SM 2819 13 T SM 2819 18 T	B x A 210 x 120  L x S 254 x 164
<b>SM 2828</b> <b>Y</b> x <b>X</b> 280 mm 280 mm 	130 180	115 165	SM 2828 13 G SM 2828 18 G	SM 2828 13 T SM 2828 18 T	B x A 210 x 210  L x S 254 x 254
<b>SM 2838</b> <b>Y</b> x <b>X</b> 380 mm 280 mm 	130 180	115 165	SM 2838 13 G SM 2838 18 G	SM 2838 13 T SM 2838 18 T	B x A 310 x 210  L x S 354 x 254

External height **Y** External width **X** External depth **Z** Free internal mounting height **C** Mounting plate assembly **B** X **A** Wall mounting **L** X **S**



**ACCESSORIES**

Product	Order symbol	Size mm
 Spacers	MR 10726	15, M6 (inner)
	MR 10727	20, M6 (inner)
	MR 10728	30, M6 (inner)
	MR 10729	54, M6 (inner)
	HR 10	10, M6/M6
	HR 15	15, M6/M6
	HR 20	20, M6/M6
	HR 30	30, M6/M6
	FA 12052	14, M5 (inner)
	FA 12053	42, M5 (inner)
 Mounting feet	MB 10686	15/34
	FX 20 set	
 Lock	MB FP88	88
	MB FP882	88
 Triangular key	MB 10674	
	MB 10673 set	
 Front plates for Solid SM enclosures	FP12-2819	
	FP12-2828	
	FP12x2-2828	
	FP12x2-2838	
	FP12x3-2838	
	FP12x3-2856	

Product	Order symbol	Size mm	Order symbol
 FIBOX SOLID HINGED COVER	EKH 30-G-2FSH	190 x 190 x 30	EKH 30-T-2FSH
	EKJ 30-G-FSH19	190 x 280 x 30	EKJ 30-T-FSH19
	EKJ 30-G-2FSH	280 x 190 x 30	EKJ 30-T-2FSH
	EKM 30-G-2FSH	380 x 190 x 30	EKM 30-T-2FSH
	EKO 30-G-2FSH	280 x 280 x 30	EKO 30-T-2FSH
	EKP 30-G-2FSH	380 x 280 x 30	EKP 30-T-2FSH
	EKT 30-G-3FSH	560 x 280 x 30	EKT 30-T-3FSH
	EKU 30-G-3FSH	560 x 380 x 30	EKU 30-T-3FSH
	EKH 80-G-2FSH	190 x 190 x 80	EKH 80-T-2FSH
	EKJ 80-G-2FSH	280 x 190 x 80	EKJ 80-T-2FSH
	EKM 80-G-2FSH	380 x 190 x 80	EKM 80-T-2FSH
	EKO 80-G-2FSH	280 x 280 x 80	EKO 80-T-2FSH
	EKP 80-G-2FSH	380 x 280 x 80	EKP 80-T-2FSH
	ABS 2819 30-G-2FSH	280 x 190 x 30	
	ABS 3819 30-G-2FSH	380 x 190 x 30	
	ABS 2828 30-G-2FSH	280 x 280 x 30	
	ABS 3828 30-G-2FSH	380 x 280 x 30	
	ABS 2819 80-G-2FSH	280 x 190 x 80	
ABS 3819 80-G-2FSH	380 x 190 x 80		
ABS 2828 80-G-2FSH	280 x 280 x 80		
ABS 3828 80-G-2FSH	380 x 280 x 80		

**FIBOX SOLID HINGED COVER**

**FULL OPENING ANGLE**  
 The hinged cover opening exceeds 180 degrees allowing complete access to the interior of the enclosure.  $>180^\circ$



**REVERSABLE LEFT / RIGHT OPENING**  
 The the hinged cover may be mounted on the left side or on the right side. Hinging is field reversible and easily accomplished.

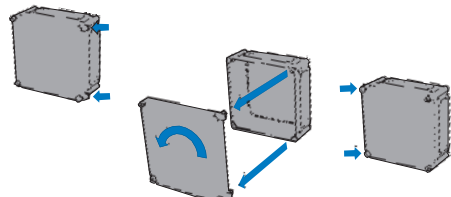

**FIBOX SOLID SC II ENCLOSURES**

These cabinets, are made from high impact resistant polycarbonate material, and will withstand harsh industrial environments. They have ready mounted hinges and quick lock screws. Protection to IP65 is maintained when fastened. The enclosure base features many internal mounting pods for various assembly requirements. SOLID SC enclosures offer a large number of accessories. Transparent cover options allow visual inspection of equipment installed inside the enclosure.

Approvals: IP65

Order symbol		Size mm
Grey cover	Transparent cover	
SC 281913 G II	SC 281913 T II	280 x 190 x 130
SC 281918 G II	SC 281918 T II	280 x 190 x 180
SC 381913 G II	SC 381913 T II	380 x 190 x 130
SC 381918 G II	SC 381918 T II	380 x 190 x 180
SC 282813 G II	SC 282813 T II	280 x 280 x 130
SC 282818 G II	SC 282818 T II	280 x 280 x 180
SC 382813 G II	SC 382813 T II	380 x 280 x 130
SC 382818 G II	SC 382818 T II	380 x 280 x 180
SC 562813 G II	SC 562813 T II	560 x 280 x 130
SC 563818 G II	SC 563818 T II	560 x 380 x 180





# FIBOX<sup>EK</sup>

FOUR EASY STEPS TO BUILD A DISTRIBUTION PANEL THAT WORKS

BASE

FURNISH

CLAD

ROOF

FIBOX EK



Medium to large size enclosures manufactured using impact resistant polycarbonate.

Available with one or more flange openings. The flange openings allow modular assembly of several enclosures and the addition of various size cable glands and knockout flanges. Select from a large selection of standard flanges or request flanges machined separately to customer specifications. The EK bases feature multiple mounting pods.

A large range of accessories is available.

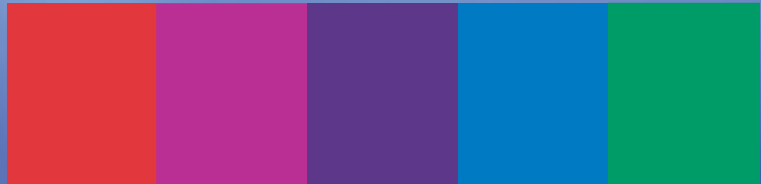

BASE

ENCLOSURE BASES

Impact-resistant, medium to large size polycarbonate enclosure with a high protection rating (IP 67). Pre-pressed flange panels can accept a variety of flange plates from the EK accessory range.

ORDER SYMBOL	SIZE mm
EKHA	190x190x100
EKHS	190x190x100
EKJB	280x190x100
EKMB	380x190x100
EKMR	380x190x100
EKOE	280x280x100
EKPE	380x280x100
EKPG	380x280x100
EKPK	380x280x150
EKPL	380x280x150
EKTH	560x280x100
EKUH	560x380x150
EKUM	560x380x150
EKUN	560x380x150
EKWH	760x560x150



THE THIRD LETTER OF THE ORDER SYMBOL INDICATES THE SIZE OF THE ENCLOSURE:  
For example the letter J in the order symbol EKJB stands for the size 280x190 mm

- H = 190x190 mm
- J = 280x190 "
- M = 380x190 "
- O = 280x280 "
- P = 380x280 "
- T = 560x280 "
- U = 560x380 "
- W = 760x560 "

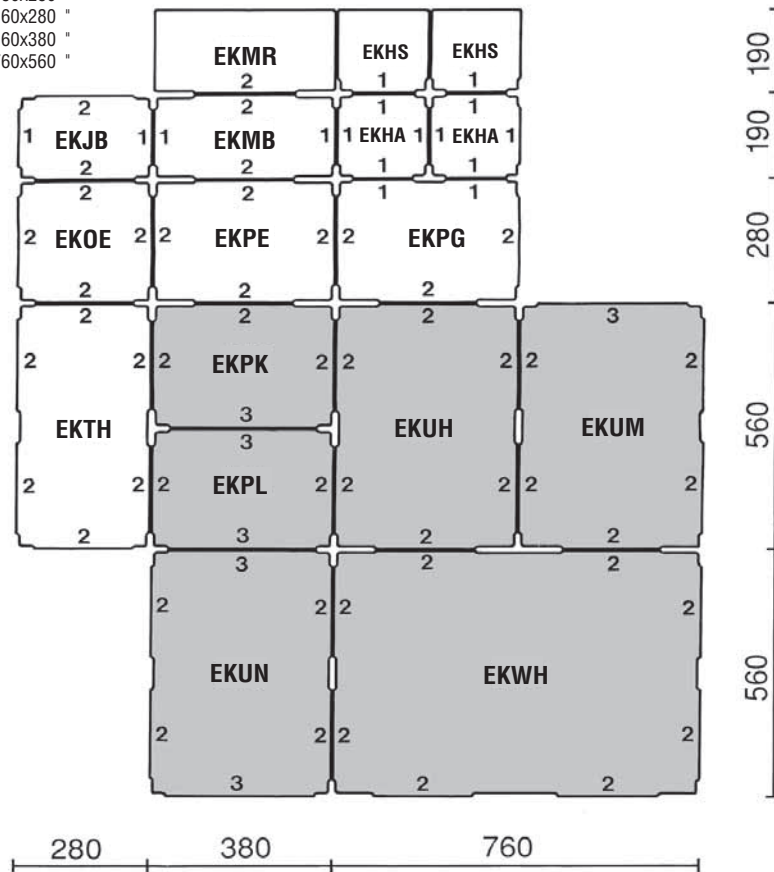

The bases marked with the grey colour have a depth of 150 mm, the others are 100 mm. The number on the bases indicates the size of the flange plate.

**BASE**

**EXAMPLE OF THE ASSEMBLY OF ONE ENCLOSURE**

 THE SIZE OF THE WHOLE ENCLOSURE ACCORDING TO THE LETTER:  
The enclosure sized (280x190x230) can be assembled as follows:

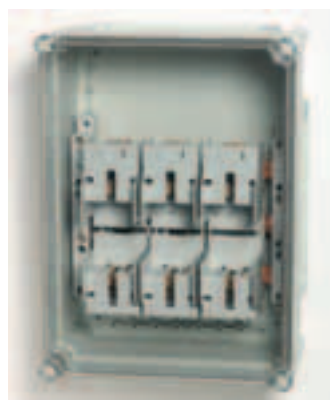
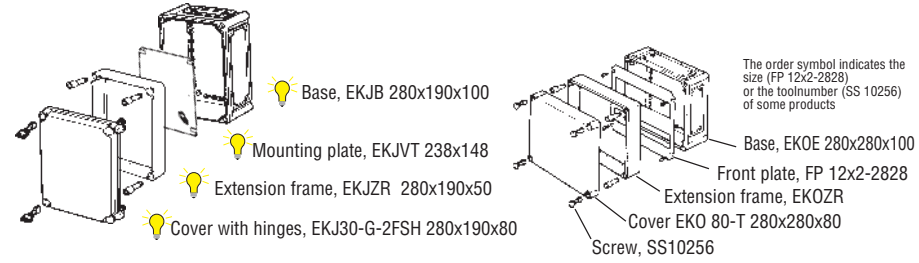

**ASSEMBLING ENCLOSURES**



The plate connectors can be used to assemble bases or flanges and bases



Plastic head screw

	ORDER SYMBOL	SIZE
Connector set + 4 screws	MB 10671	1
Connector set + 4 screws	MB 10670	2
Connector set + 4 screws	MB 10672	3
Plastic head screw for the assembly of bases with size 1 opening	MB 10472	M6x30
Plastic head screw for the assembly of bases with size 2 openings	MB 10474	M8x30
Lock nuts for plastic head screws	M6	M6
	M8	M8

**EXTENSION FRAMES**

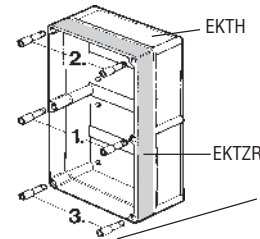

Extension frame 50 mm, between base and cover.

ORDER SYMBOL	SIZE mm
EKJZR	280x190x50
EKMZR	380x190x50
EKOZR	280x280x50
EKPZR	380x280x50
EKTZR	560x280x50
EKUZR	560x380x50

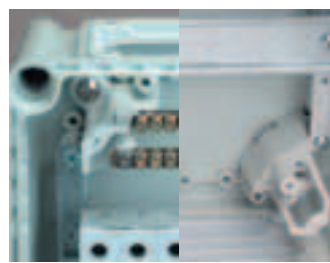

**SUPPORT FLANGES**



	ORDER SYMBOL	SIZE
Support flange	MB 10025	2
Support flange	MB 10026	1

**WALL FASTENING LUG**

Separate enclosures and small distribution panels (2-4 enclosures) can be assembled straight to the wall with screws or with wall fastening lugs.

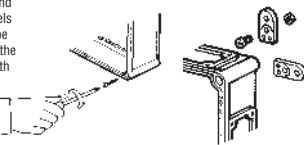

	ORDER SYMBOL
Wall fastening lug set, 4 pcs incl. screws	MB 10674

**FASTENING OF BIG SYSTEMS**

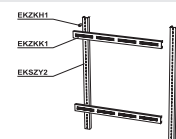

	ORDER SYMBOL
Connecting rail, standard length 2000 mm	EKZKK1
Stud rail, standard length 2000 mm	EKSZY2
Lock for connecting rail	EKZKH1

**THE BASE CONNECTORS**

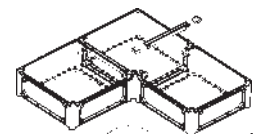

	ORDER SYMBOL	SIZE
Connection bridge and gasket	MB 10717	2
Connection bridge and gasket	MB 10718	3

The plate connectors can be used for assembling bases together or flanges to bases.

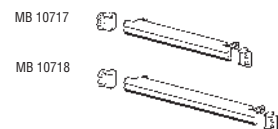

FURNISH

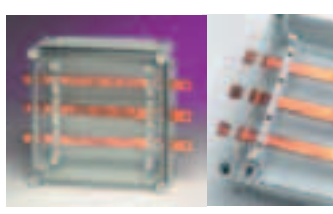
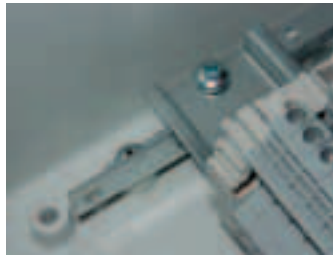

**MOUNTING PLATES**

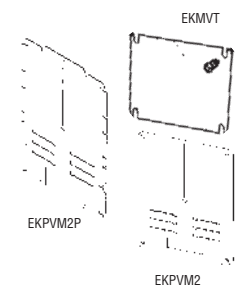

Mounting plate, metal  
 Mounting plate, metal  
 Mounting plate, metal  
 Mounting plate, metal  
 Mounting plate, metal  
 Mounting plate, metal  
 Mounting plate, metal

ORDER SYMBOL	SIZE mm
EKHVT	148x148
EKJVT	238x148
EKMVT	338x148
EKVVT	238x238
EKPVT	338x238
EKTVT	518x238
EKUVT	518x338

**Note!**  
 EK-mounting plates also for Solid-enclosure.

KWh-mounting plate, metal  
 KWh-mounting plate, plastic  
 Accessory screws for mounting the KWh meter

EKPVM2	338x238
EKPVM2P	338x238
M6x16	6x16

**DIN RAILS**

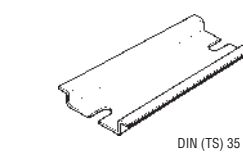

DIN-rail  
 DIN-rail  
 DIN-rail  
 DIN-rail  
 Self-cutting mounting screw

ORDER SYMBOL	SIZE mm
EKV 12	35x160
EKV 22	35x235
EKV 32	35x335
EKV 50	35x500
MSM PT 5x10	4.8x9.5

**DIN RAIL FRAME**



DIN frame profile  
 DIN frame profile  
 DIN frame profile  
 DIN frame profile

ORDER SYMBOL	SIZE mm
MS PROF 19	87
MS PROF 28	166
MS PROF 38	266
MS PROF 56	444

Screws for DIN-rail (terminal) assembly order MSM PT 5x10

**FX FP FRONT PLATES FX20 SET -CORNER STUDS**

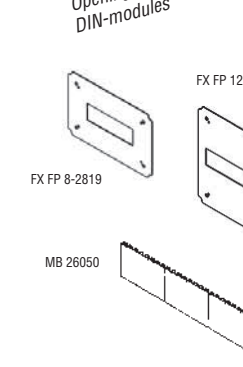

Blue 2 mm PC front plate  
 Blue 2 mm PC front plate  
 Blue 2 mm PC front plate  
 Blue 2 mm PC front plate

ORDER SYMBOL	SIZE mm
FX FP 8-2819	280x190
FX FP 12-2828	280x280
FX FP 2*12-2838	280x380
FX FP 3*12-2856	280x560

Cover plate (12 mod.)

MB 26050	
----------	--

**CORNER STUD FX 2000**

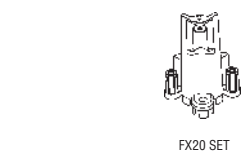

Set of corner studs FX 2000  
 Corner stud FX 2000 (separate)  
 Front plate screw FX 2000  
 PE/N brass bar  
 Screws for mounting PE/N brass bar

ORDER SYMBOL	SIZE mm
FX20 SET	
MB 10791	
MB 10792	
MS BAR 2+18	10x6.5x187
MR 28005EU	40x18



## FURNISH

### MB FP FRONT PLATES FOR MB 60MM BUS-BAR HOLDES

	ORDER SYMBOL	SIZE mm
 MB FP 2828 Blue 2 mm PC front plate	MB FP 2828	280x280
 MB FP 3828 Blue 2 mm PC front plate	MB FP 3828	380x280
 MB FP 5628 Blue 2 mm PC front plate	MB FP 5628	560x280

### 60 MM BUS-BAR

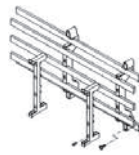

Bus-bar support set  
incl. screws and support

ORDER SYMBOL

MB 60MM

For assembling to middle of the enclosure use screws KN4.8x13

RATED CURRENT	250 A	400 A
Bus-bar sizes	L1, L2, L3 20 x 5 mm	20 x 10 mm
	PE/N 15 x 5 mm	15 x 5 mm

### SOLID FRAME COVERS

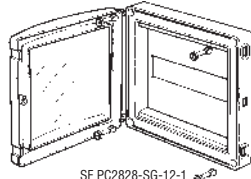

SF PC2828-SG-12-1



MB 10686

	ORDER SYMBOL	SIZE mm
Solid Frame covers		
With opening 1x12 mod.	SF PC2828-SG-12-1	280x280x54
With opening 2x12 mod.	SF PC2828-SG-12-2	280x280x54

DIN-rail









EKV 22

35x235









Note!  
SOLIDFRAME cover fits to  
EKOE and SOLID 2828 bases

Extension for DIN rail/mbc MB 10686 15/34

### SPACERS

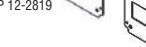
	ORDER SYMBOL	SIZE mm
 M6 spacers, self-cutting for corners of the base	MR 10726	15
 M6 spacers, self-cutting for corners of the base	MR 10727	20
 M6 spacers, self-cutting for corners of the base	MR 10728	30
 M6 spacers, self-cutting for corners of the base	MR 10729	54
 M6/M6 extension for MR spacer	HR 10	10
 M6/M6 extension for MR spacer	HR 15	15
 M6/M6 extension for MR spacer	HR 20	20
 M6/M6 extension for MR spacer	HR 30	30
 M5 spacers, self-cutting for middle mounting pods	FA 12052	42
	FA 12053	14

### FP FRONT PLATES FOR FB88 AND FP882 SPACERS

	ORDER SYMBOL	SIZE mm
 MB FP88 Distance spacer for front plates, 1set, 2 pcs	MB FP88	88
 MB FP882 Distance spacer for front plates, 1set, 2 pcs	MB FP882	88
 FP 12-2819 FP front plate with DIN-openings	FP12-2819	280x190
 FP 12-2828 FP front plate with DIN-openings	FP12-2828	280x280
 FP 12x2-2828 FP front plate with DIN-openings	FP12x2-2828	280x280
 FP 12x2-2838 FP front plate with DIN-openings	FP12x2-2838	280x380
 FP 12x3-2838 FP front plate with DIN-openings	FP12x3-2838	280x380
 FP 12x3-2856 FP front plate with DIN-openings	FP12x3-2856	280x560
N/PE-terminal bracket, incl. 2 pcs of MR 26100 terminals (16-holes)	MB 26069SET	
Terminal bus-bar clamp, 25 mm <sup>2</sup>	MS BAR CLAMP	
Terminal bus-bar clamp, 35 mm <sup>2</sup>	MR 26145	





**GLAD**

**PLATES**

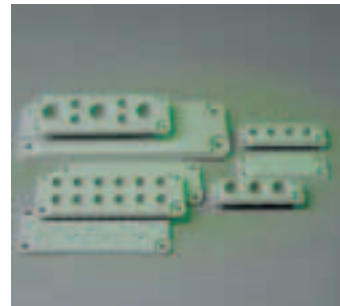

ORDER SYMBOL	SIZE
MB 10215	1
MB 10546	2
MB 10324	3
MB 10151	1
MB 10149	1
MB 10214	1
MB 10537	1
MB 10892	1
MB 10014	2
MB 10015	2
MB 10016	2
MB 10017	2
MB 10019	2
MB 10891	2
MB 10593	2
MB 10594	2
MB 10595	2
MB 10596	2
MB 10856	2
MB 10857	2
MB 10889	2
MB 10890	2
MK 10437	1
MK 10438	2
MK 10439	3
MK 10440	1
MK 10441	2
MB 10671	1
MB 10670	2
MB 10672	3
EKZA 7	1
EKZA 8	2
EKZA 9	3
MB 10345	M6x25
MB 10346	M8x25
MB 10347	M10x30
M6	M6
M8	M8
M10	M10

The plate connectors can be used to assemble flanges and bases



Plastic head screw

**MEMBRANE FLANGE PLATE**

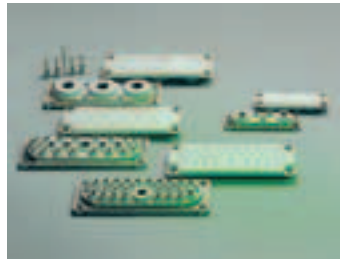

ORDER SYMBOL	SIZE
FMB 5	1
FMC 3	2
FMC 25	2
FMC 35	2

FMB 5 assembly: order MB 10671 connector set  
FMC 3, -25, -35: "fast" connectors incl. delivery

**PLATE EXTENSION**



ORDER SYMBOL	SIZE
MB 10391	2
MB 10392	

**WATER PLUG VENTILATOR**



ORDER SYMBOL	SIZE
MB 12189	
MB 10894	
MB 10631	
MB 10564 II	
MB 10858 II	
MB 10859 II	

GLAD

CABLE ENTRY BOXES

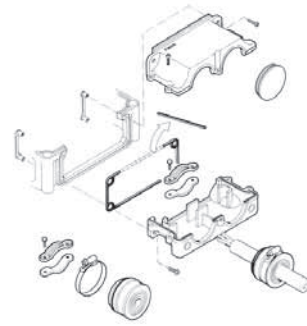

ORDER SYMBOL

Including: base, cover, cover screws, 1 blind plug, 1 pull-off, hose clamp with screws, membrane cable gland, and plate connector set.

MB 2260

Accessory set  
Including: membrane cable gland, pull-off, and hose clamp with screws.

MB 2260A



Use plastic head screws for assembly

CABLE ENTRY

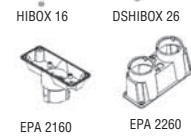
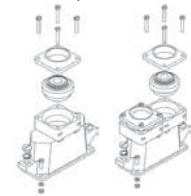

ORDER SYMBOL

FLANGE SIZE

Cable entry, 1 cable (incl. rubber gasket)  
Cable entry, 2 cables (incl. rubber gasket)

HIBOX 16

2

DSHIBOX 26

2

Cable entry (1 cable)  
Cable entry (2 cables)  
Cable entry (1 cable)  
Cable entry (2 cables)

EPA 1130

1

EPA 1230

1

EPA 2160

2

EPA 2260

2

Rubber gasket for cable entry EPA 1130-1230  
Rubber gasket for cable entry EPA 2160-2260

MK 10426

SIZE MM  
10-31

MK 10428

28-60



CABLE GLANDS

METRIC!



Metric Cable gland, PA

ORDER SYMBOL

FOR CABLE

METRIC SIZE

CLEARANCE HOLE Ø mm

mm

mm

PA=cable glands in polyamide

Grey RAL 7035

Temperature range  
-40° (-+100°)

New metric dimensions EN 60423!

GPA M12

3-6

M12x1,5

12,5

GPA M16

5-10

M16x1,5

16,5

GPA M20

8-13

M20x1,5

20,5

GPA M25

11-17

M25x1,5

25,5

GPA M32

15-21

M32x1,5

32,5

GPA M40

19-28

M40x1,5

40,5

GPA M50

27-35

M50x1,5

50,5

GPA M63

32-42

M63x1,5

60,5



Metric Hexagonal lock nut PA

GPA M12-B

M12x1,5

GPA M16-B

M16x1,5

B=lock nuts for cable gland, polyamide

GPA M20-B

M20x1,5

GPA M25-B

M25x1,5

GPA M32-B

M32x1,5

GPA M40-B

M40x1,5

GPA M50-B

M50x1,5

GPA M63-B

M63x1,5



Membrane cable glands

EPDM

IP 65 (EN 60529)

Wall thickness (C) 1,5 -5 mm

FEM 3-5

3-5

M12

12,5

FEM 5-7

5-7

M16

16,5

FEM 7-10

7-10

M20

20,5

FEM 10-14/23

10-14

M23/PG16

23,5

FEM 10-14/25

10-14

M25

25,5

FEM 14-20

14-20

M32

32,5

FEM 20-26

20-26

M40

40,5

FEM 26-35

26-35

M50

50,5

FEM 30-45

30-45

M60

60,5



Multifem

MFM 8-12

3x6-10, 3x10-14

M50

50,5

ORDER SYMBOL

FOR CABLE

CLEARANCE HOLE, PG

mm

mm

Membrane cable glands

Flame resistance UL 96-V2

Grey RAL 7035

Temperature range

-50°C -+70°C

Fet 5-7 for cables 5-7 ø

Fet 7-10 for cables 7-10 ø etc.

FET 5-7

5-7

PG 9

FET 7-10

7-10

PG 11

FET 8-14

8-14

PG 16

FET 14-20

14-20

PG 21

FET 20-26

20-26

PG 29

FET 26-35

26-35

PG 36



ROOF



Cover = EKH 30 T (G)



Cover = EKJ 30 T (G)



Cover = EKM 30 T (G)



Cover = EKO 30 G (T)



Cover = EKP 30 T (G)



Cover = EKP 30 T (G)



Cover = EKT 30 G (T)



Cover = EKT 30 T (G)



Cover = EKW 100 G

**COVERS**

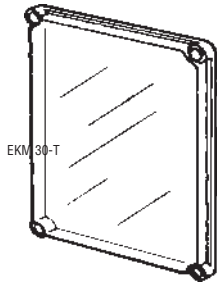

Eight sizes of base and cover.  
Three depths for cover 30, 80, 100 mm.  
Note! (EKW only with grey colour)  
Note! Order cover screws against the cover height.

EK-covers (PC)  
G=grey cover RAL 7035  
T=transparent cover  
Height 30 mm.

ORDER SYMBOL	SIZE mm
EKH 30-T	190x190x30
EKH 30-G	190x190x30
EKJ 30-T	280x190x30
EKJ 30-G	280x190x30
EKM 30-T	380x190x30
EKM 30-G	380x190x30
EKO 30-T	280x280x30
EKO 30-G	280x280x30
EKP 30-T	380x280x30
EKP 30-G	380x280x30
EKT 30-T	560x280x30
EKT 30-G	560x280x30
EKU 30-T	560x380x30
EKU 30-G	560x380x30

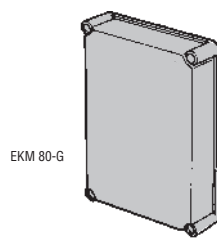

EK-covers (PC)  
G=grey cover RAL 7035  
T=transparent cover  
Height 80 mm.

More space with extension frames

ORDER SYMBOL	SIZE mm
EKH 80-T	190x190x80
EKH 80-G	190x190x80
EKJ 80-T	280x190x80
EKJ 80-G	280x190x80
EKM 80-T	380x190x80
EKM 80-G	380x190x80
EKO 80-T	280x280x80
EKO 80-G	280x280x80
EKP 80-T	380x280x80
EKP 80-G	380x280x80
EKW 100-G	760x560x100

**HINGED COVER**

FIBOX COVERS WITH READY ASSEMBLED FSH HINGES

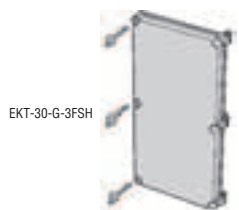

EKT-30-G-3FSH

Low cover 30 mm.  
G=grey cover RAL 7035  
T=transparent cover



Incl. cover and 2 pcs or 3 pcs HS-wing head (2FSH/3FSH) screws.



High cover 80 mm.  
G=grey cover RAL 7035  
T=transparent cover

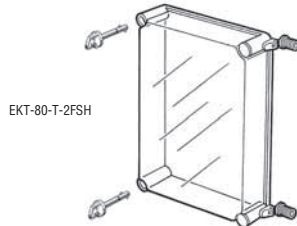

EKT-80-T-2FSH

ORDER SYMBOL	SIZE mm
EKH 30-G-2FSH	190x190x30
EKH 30-T-2FSH	190x190x30
EKJ 30-G-FSH19	190x280x30
EKJ 30-T-FSH19	190x280x30
EKJ 30-G-2FSH	280x190x30
EKJ 30-T-2FSH	280x190x30
EKM 30-G-2FSH	380x190x30
EKM 30-T-2FSH	380x190x30
EKO 30-G-2FSH	280x280x30
EKO 30-T-2FSH	280x280x30
EKP 30-G-2FSH	380x280x30
EKP 30-T-2FSH	380x280x30
EKT 30-G-3FSH	560x280x30
EKT 30-T-3FSH	560x280x30
EKU 30-G-3FSH	560x380x30
EKU 30-T-3FSH	560x380x30
EKH 80-G-2FSH	190x190x80
EKH 80-T-2FSH	190x190x80
EKJ 80-G-2FSH	280x190x80
EKJ 80-T-2FSH	280x190x80
EKM 80-G-2FSH	380x190x80
EKM 80-T-2FSH	380x190x80
EKO 80-G-2FSH	280x280x80
EKO 80-T-2FSH	280x280x80
EKP 80-G-2FSH	380x280x80
EKP 80-T-2FSH	380x280x80

**HINGES, BLIND PLUG**

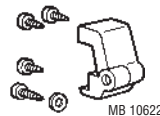

MB 10622



MB 10523

PC hinge set, 1 pair, incl. screws and drill template  
PA hinge set, 1 pair, incl. screws  
Template for MB 10547 in plastic  
Blind plug for cover corner on hinged side when cover screws are not used

ORDER SYMBOL	SIZE mm
MB 10622	30/80
MB 10547	30/80
PA 10547	
MB 10523	

ROOF

COVERS SCREWS

	ORDER SYMBOL	FOR COVERS
Wing head screw	HS 10255	30
Slotted head screw, sealable	SS 10535	30
Triangle head screw	DS 10581	30/80/100
Cross head screw	CS 10256	30/100
Slotted head screw, quick-lock, *)	SS 10544	30/100
Wing head screw, quick-lock, *)	HS 10533	30
Quick-locking wing head screw, hinged, *)	HS 10532	30
*) Threaded bushing	MB 10534	
*) Threaded bushing (needed for quick-locking screws)		
Cross head screw	SS 10563	80
Wing head screw	HS 10562	80
Noryl slotted head screw (good chemical resistance)	SS 10256N	30
Noryl wing head screw (good chemical resistance)	HS 10255N	30
Set of four cross head screws	SS 10256-4	30/100
Set of six cross head screws	SS 10256-6	30/100
Set of four cross head screws	SS 10563-4	80

SOLID FRAME

	ORDER SYMBOL	SIZE mm
Frame, with opening	Cover 28/28-0	280x280
Front plate aluminium	FP 28/28	
Frame, no opening	Cover 28/28-D	280x280
Key lock set	MR 26065	

*Solid Frames also fit EKOE and SOLID 2828 bases.*

KEY-LOCK SET

	ORDER SYMBOL
Key-lock set incl., lock and 2 keys for 30 mm covers	MB 10597

INSPECTION WINDOWS

The order symbol indicates the amount of the DIN modules for example L08=8 modules.

	ORDER SYMBOL	SIZE mm
Windows, IP 65	L12 II	248x128
Windows, IP 65	L24 II	248x128
Windows, IP 65	L12	248x128
Windows, IP 65	L24	248x128
Windows, IP 65	L13	257x108
Windows, IP 54	L10	199x77
Windows, IP 54	L08	162x77
Windows, IP 54	L06	130x77
Windows, IP 54	L04	96x77
Windows, IP 54	L02	60x77
Front plates for L 12 windows	B 12 10621-45	
Front plates for L 24 windows	B 24 10620-45	
Large size windows, IP 65,	L44 II	377x331
for enclosure EKW 100-G	L43 II	331x277



L 12 clear

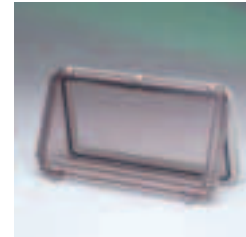

L 12 II transparent smoked grey



L 13 clear



SOLID FRAME application

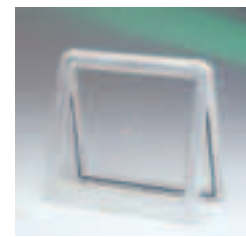

L 24 clear



L 44 II transparent smoked grey



L 43 II transparent smoked grey



**DIMENSIONAL DRAWINGS**

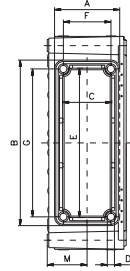

FLANGE OPENINGS								
Plate size	Dimensions							
	A	B	C	D	E	F	G	M
1	48	138	33	7	121	30	120	31
2	86	217	63	9,5	195	62	193	52
3	127	332	101	11,5	306	80	292	71

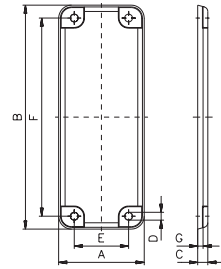

COVER PLATES								
Order symbol	Plate size	Dimensions						
		A	B	C	D	E	F	G
MB 10215	1	49	140,5	10	7	30	120	5
MB 10546	2	85	217	10	9,5	62	193	5
MB 10324	3	127	332	15	11,5	80	292	8

**TECHNICAL INFORMATION**

PROPERTY	POLYCARBONATE (PC)	CONFORMITY TO STANDARDS
Ingress Protection (EN 60529)	IP66/IP67	<b>USA</b> Enclosures for Electrical Equipment PC: UL Type 1, 3, 3S, 4, 4X, 6, 6P and 12 (UL 50/508)
Impact Resistance (EN 50102)	IK 08	<b>Canada</b> Industrial Control Equipment Enclosures for Electrical Equipment/ULc
Temperature Range (short term)	Celsius: -40°...120°C Fahrenheit: -40°...250°F	<b>Europe</b> Enclosures for Switch Gear and Control Gear Assemblies EN 50298:1998
Temperature Range (continuous)	Celsius: -40°...80°C Fahrenheit: -40°...175°F	<b>Europe</b> Safety of Information Technology Equipment EN 60950
Electrical Insulation	Totally insulated <input checked="" type="checkbox"/>	<b>Australia</b> Enclosures for switch gear and control gear AS 3132-1991
Light Grey Parts Colour	RAL 7035 Industry Grey	<b>DNV</b> PC: DNV Rules for Classification of Ships and Mobile Offshore Units
Transparent Clear PC Cover	Clear Transparent	<b>GL</b> PC: GL Regulations for the Performance of Type Test, Part 1
Cover Screws	RAL 7035	
Cover Screws	Polyamide (PA)	<b>LR</b> Marine offshore and industrial installations
Gasket	PUR	<b>BV</b> BV Rules
Enclosure Flammability Rating	UL94-5V	UL 746 C 5 in. vertical flame test
Glow Wire Test	960°C	IEC 695-2-1, Self-extinguishing
Non-toxicity	Halogen Free	DIN/VDE 0472, Part 815
UV resistance	UL 508 720 hours in "Weatherometer"	<b>CE, FI</b> -mark
Chemical Resistance *	Good	

Data subject to change without notice. \*Consult separate raw material data for more detailed information

**NEW!**

**EK enclosure sets**

Some most popular EK sizes are now available as complete enclosures with just one order symbol.

Sets include base, cover and cover screws. Naturally same wide SOLID/EK accessory range allows you to customise these "easy-to-order" sets to your needs.

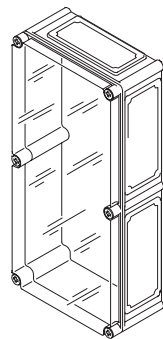

EKTH 130 T

ORDER SYMBOL	SIZE mm
EKHA 130 G	190x190x130
EKJB 130 G	280x190x130
EKMB 130 G	380x190x130
EKOE 130 G	280x280x130
EKPE 130 G	380x280x130
EKTH 130 G	560x280x130
EKUH 180 G	560x380x180
EKWH 250 G	760x560x250
EKHA 130 T	190x190x130
EKJB 130 T	280x190x130
EKMB 130 T	380x190x130
EKOE 130 T	280x280x130
EKPE 130 T	380x280x130
EKTH 130 T	560x280x130
EKUH 180 T	560x380x180





# FIBOX

## CAB QUICK



FIBOX CAB HINGED DOOR WITH KEY LOCK OR LATCH

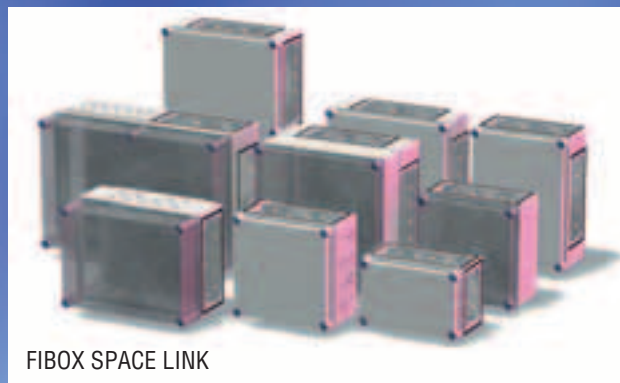

FIBOX SPACE LINK

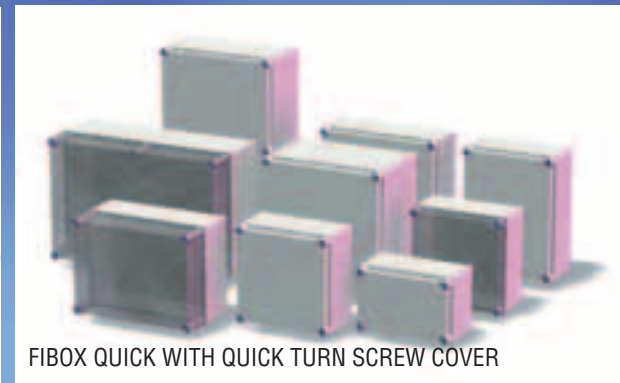





FIBOX QUICK WITH QUICK TURN SCREW COVER

FIBOX CAB PC/ABS wall mounting cabinets are manufactured using high impact resistant polycarbonate or ABS material, withstanding harsh, hostile industrial environments. The FIBOX QUICK lock system allows easy access to the enclosure, while still ensuring tight sealing. The enclosure is rated EN 60529 IP66/IP67. The cabinet base features numerous internal mounting pods, allowing ease in component assembly and installation. FIBOX CAB PC/ABS (hinged one), FIBOX QUICK PC/ABS (screw cover). Transparent "smoked grey" cover options allows easy viewing of installed control equipment and indicators.

**FIBOX CAB, FIBOX QUICK, FIBOX SPACE LINK**



# FIBOX CAB PC/ABS





CAB ENCLOSURE WITH KEY LOCKS PC: IP 65, IK 08 ABS: IP 65, IK 08	Z mm	C mm	Including: Cabinet base, door with EPDM gasket, 3 mm double bit lock(s) with key, hinges, mounting plate screws, and corner plugs.		B X A L X S mm
			ORDER SYMBOL Grey door 3 mm double bit key	ORDER SYMBOL Smoked transparent cover 3 mm double bit key	
CAB PC/ABS 302018 G3B CAB PC/ABS 302018 T3B <b>Y</b> X <b>X</b> 300 mm 200 mm 	180 180	168 168	CAB PC 302018 G3B CAB ABS 302018 G3B	CAB PC 302018 T3B CAB ABS 302018 T3B	B x A 260 x 160  L x S 272 x 172
CAB PC/ABS 303018 G3B CAB PC/ABS 303018 T3B <b>Y</b> X <b>X</b> 300 mm 300 mm 	180 180	168 168	CAB PC 303018 G3B CAB ABS 303018 G3B	CAB PC 303018 T3B CAB ABS 303018 T3B	B x A 260 x 260  L x S 272 X 272
CAB PC/ABS 403018 G3B CAB PC/ABS 403018 T3B <b>Y</b> X <b>X</b> 400 mm 300 mm 	180 180	167 167	CAB PC 403018 G3B CAB ABS 403018 G3B	CAB PC 403018 T3B CAB ABS 403018 T3B	B x A 260 x 360  L x S 372 x 272
CAB PC/ABS 504020 G3B CAB PC/ABS 504020 T3B <b>Y</b> X <b>X</b> 500 mm 400 mm 	200 200	185 185	CAB PC 504020 G3B CAB ABS 504020 G3B	CAB PC 504020 T3B CAB ABS 504020 T3B	B x A 360 x 460  L x S 472 x 372
CAB PC/ABS 604022 G3B CAB PC/ABS 604022 T3B <b>Y</b> X <b>X</b> 600 mm 400 mm 	220 220	207 207	CAB PC 604022 G3B CAB ABS 604022 G3B	CAB PC 604022 T3B CAB ABS 604022 T3B	B x A 360 x 560  L x S 572 x 372

External height **Y** External width **X** External depth **Z** Free internal mounting height **C** Mounting plate assembly **B** X **A** Wall mounting **L** X **S**

T= smoked transparent cover G= grey cover

# FIBOX CAB PC/ABS

FIBOX CAB

CAB ENCLOSURE WITH LATCHES PC: IP 65, IK 08 ABS: IP 65, IK 08	Z mm	C mm	Including: Cabinet base, door with EPDM gasket, hinges, latches, mounting plate screws, and corner plugs.		B x A L x S mm
			ORDER SYMBOL	ORDER SYMBOL	
			Grey door Hinges on short sides	Smoked transparent cover Hinges on long side	
<b>CAB PC/ABS 203018</b> <b>CAB PC/ABS 302018</b> <b>Y</b> x <b>X</b> 300 mm 200 mm 	180 180 180 180	168 168 168 168	CAB PC 203018 G CAB PC 203018 T CAB ABS 203018 G CAB ABS 203018 T	CAB PC 302018 G CAB PC 302018 T CAB ABS 302018 G CAB ABS 302018 T	B x A 260 x 160  L x S 272 x 172
<b>CAB PC/ABS 303018</b> <b>Y</b> x <b>X</b> 300 mm 300 mm 	180 180 180 180	168 168 168 168	CAB PC 303018 G CAB PC 303018 T CAB ABS 303018 G CAB ABS 303018 T		B x A 260 x 260  L x S 272 x 272
<b>CAB PC/ABS 304018</b> <b>CAB PC/ABS 403018</b> <b>Y</b> x <b>X</b> 400 mm 300 mm 	180 180 180 180	167 167 167 167	CAB PC 304018 G CAB PC 304018 T CAB ABS 304018 G CAB ABS 304018 T	CAB PC 403018 G CAB PC 403018 T CAB ABS 403018 G CAB ABS 403018 T	B x A 260 x 360  L x S 372 x 272
<b>CAB PC/ABS 405020</b> <b>CAB PC/ABS 504020</b> <b>Y</b> x <b>X</b> 500 mm 400 mm 	200 200 200 200	185 185 185 185	CAB PC 405020 G CAB PC 405020 T CAB ABS 405020 G CAB ABS 405020 T	CAB PC 504020 G CAB PC 504020 T CAB ABS 504020 G CAB ABS 504020 T	B x A 360 x 460  L x S 472 x 372
<b>CAB PC/ABS 604022</b> <b>Y</b> x <b>X</b> 600 mm 400 mm 	220 220 220 220	207 207 207 207		CAB PC 604022 G CAB PC 604022 T CAB ABS 604022 G CAB ABS 604022 T	B x A 560 x 360  L x S 572 x 372

External height **Y** External width **X** External depth **Z** Free internal mounting height **C** Mounting plate assembly **B** x **A** Wall mounting **L** x **S**

T= smoked transparent cover G= grey cover

# FIBOX CAB PC/ABS

## SYMBOLS AND ABBREVIATIONS

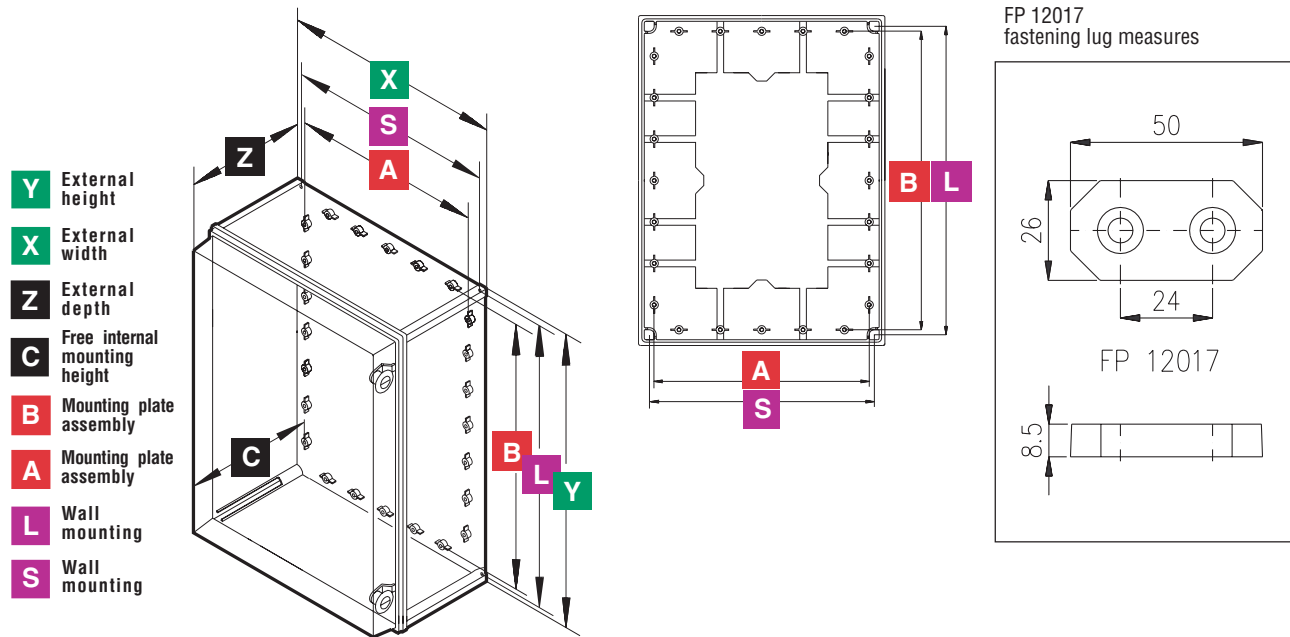
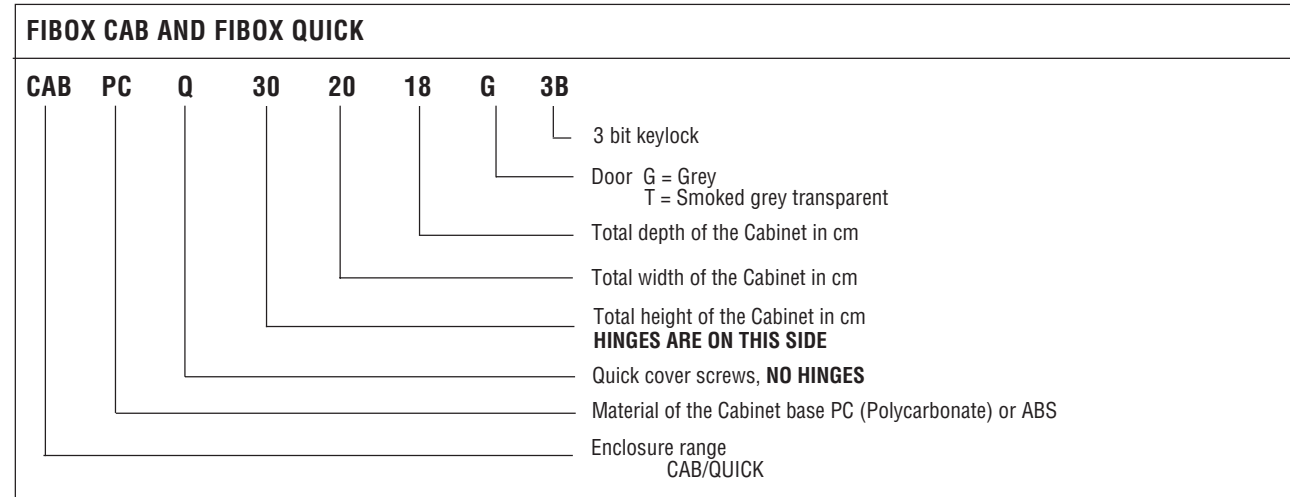

## TECHNICAL INFORMATION FOR CAB ENCLOSURES

PROPERTY	POLYCARBONATE (PC)	ABS	CONFORMITY TO STANDARDS (UL, CSA, CE, Lloyds, BV, FI)
Ingress Protection (EN 60529)	IP65	IP65	<b>USA</b> Enclosures for Electrical Equipment PC: UL Type 1, 4, 4X, 12 and 13 (UL 50/508) ABS: NEMA 1, 4, 4X, 12 and 13
Impact Resistance (EN 50102)	IK 08	IK 08	<b>Canada</b> Industrial Control Equipment Enclosures for Electrical Equipment/ULc
Temperature Range (short term)	Celsius: -40°...120°C Fahrenheit: -40°...250°F	-40°...80°C -40°...175°F	<b>Europe</b> Enclosures for Switch Gear and Control Gear Assemblies EN 50298:1998
Temperature Range (continuous)	Celsius: -40°...80°C Fahrenheit: -40°...175°F	-40°...60°C -40°...140°F	<b>Europe</b> Safety of Information Technology Equipment EN 60950
Electrical Insulation	Totally insulated <input type="checkbox"/>	Totally insulated <input type="checkbox"/>	<b>Australia</b> Enclosures for switch gear and control gear AS 3132-1991
Light Grey Parts Colour	RAL 7035 Industry Grey	RAL 7035 Industry Grey	
Transparent Clear PC Cover	Smoked Grey	Smoked Grey	
Hinges and Latches (PC)	RAL 7035	RAL 7035	
Gasket	PUR/EPDM	PUR/EPDM	
Enclosure Flammability Rating	UL94-5V	UL94HB	UL 746 C 5 in. vertical flame test
Glow Wire Test	960°C	650°C	IEC 695-2-1, Self-extinguishing
Non-toxicity	Halogen Free	Halogen Free	
UV resistance	UL 508		
Chemical Resistance *	720 hours in "Weatherometer" Good	Good	

Data subject to change without notice. \*Consult separate raw material data for more detailed information

# FIBOX CAB PC/ABS

## POLYCARBONATE AND ABS CABINETS WITH KEY LOCKS OR WITH LATCHES

POLYCARBONATE AND ABS CAB PC / ABS enclosures feature innovative design and unique latch and locking options. Optional smoked transparent covers provide excellent visibility plus UV protection for internal components.

### HINGED INNER PANEL (SWING DOOR)

For instrumentation mounting, aluminium inner panels can be hinged right or left. Panels swing a full 90 degrees permitting total access to components mounted inside the cabinet.

**SWING DOOR**

Pat.Reg. 400865

**WALL FASTENING FEET**  
Wall mounting is achieved directly through the enclosure or by using optional wall mounting feet for hanging the enclosure.

### ADJUSTABLE DEPTH

Unique brackets allow inner panels to be mounted at different depths. Panels can be mounted either as hinged or fixed.

MOUNTING FRAMES







**PADLOCKABLE LATCH**  
Enclosures are available hinged either on the long or short side. Quick release latches feature a built-in provision for padlocking.

**KEY LOCK**  
CAB enclosures are available with a 1/4 turn DIN lock supplied with a standard 3mm double bit plastic key.

**FIBOX CAB**



# FIBOX QUICK

FIBOX QUICK PC AND ABS ENCLOSURE PC and ABS: IP 66/IP 67, IK 08	Z mm	C mm	Including: Enclosure base, cover, screws 4x CS12137, and mounting screws.			B x A mm
			ORDER SYMBOL Grey cover		ORDER SYMBOL Smoked transparent cover	
CAB PCQ 23 CAB ABSQ 23  Y x X 300 mm x 200 mm	170 170	158 158	CAB PCQ 302017 G CAB ABSQ 302017 G		CAB PCQ 302017 T CAB ABSQ 302017 T	B x A 260 x 160  L x S 272 x 172
CAB PCQ 33 CAB ABSQ 33  Y x X 300 mm x 300 mm	170 170	158 158	CAB PCQ 303017 G CAB ABSQ 303017 G		CAB PCQ 303017 T CAB ABSQ 303017 T	B x A 260 x 260  L x S 272 x 272
CAB PCQ 43 CAB ABSQ 43  Y x X 400 mm x 300 mm	170 170	158 158	CAB PCQ 403017 G CAB ABSQ 403017 G		CAB PCQ 403017 T CAB ABSQ 403017 T	B x A 360 x 260  L x S 372 x 272
CAB PCQ 44 CAB ABSQ 44  Y x X 400 mm x 400 mm	170 170	158 158	CAB PCQ 404017 G CAB ABSQ 404017 G	+100 +100 EKI EXT 44 Extension frame for multi- times additional 100 mm	CAB PCQ 404017 T CAB ABSQ 404017 T  EKI EXT 44	B x A 360 x 360  L x S 372 x 372
CAB PCQ 63  Y x X 600 mm x 300 mm	170	158	CAB PCQ 603017 G		CAB PCQ 603017 T	B x A 560 x 260  L x S 572 x 272
CAB PCQ 64 CAB ABSQ 64  Y x X 600 mm x 400 mm	210 210	198 198	CAB PCQ 604021 G CAB ABSQ 604021 G		CAB PCQ 604021 T CAB ABSQ 604021 T	B x A 560 x 360  L x S 572 x 372
	270 270	258 258	CAB PCQ 604027 G CAB ABSQ 604027 G		CAB PCQ 604027 T CAB ABSQ 604027 T	

External height **Y** External width **X** External depth **Z** Free internal mounting height **C** Mounting plate assembly **B** x **A** Wall mounting **L** x **S**

FIBOX QUICK – QUICK TURN COVER SCREW

**HINGED INNER PANEL (SWING DOOR)**

For instrumentation mounting, aluminium and insulated plastic inner panels can be hinged right or left. Panels swing a full 90 degrees permitting total access to components mounted inside the cabinet.

**ADJUSTABLE DEPTH**

Unique brackets allow panels to be mounted at different depths. Panels can be mounted either as hinged or fixed.

**NEW DESIGN WITH STYLE**

- Increased wall thickness adds strength and rigidity
- Smoked grey transparent cover provides excellent component visibility
- More flexibility in component mounting with large number of mounting pods
- Lower weight when compared with fibreglass or metal
- Smooth surfaces for nomenclature, decals and overlays

**QUICK LOCK SCREWS**

Quarter turn screws have optional head designs.

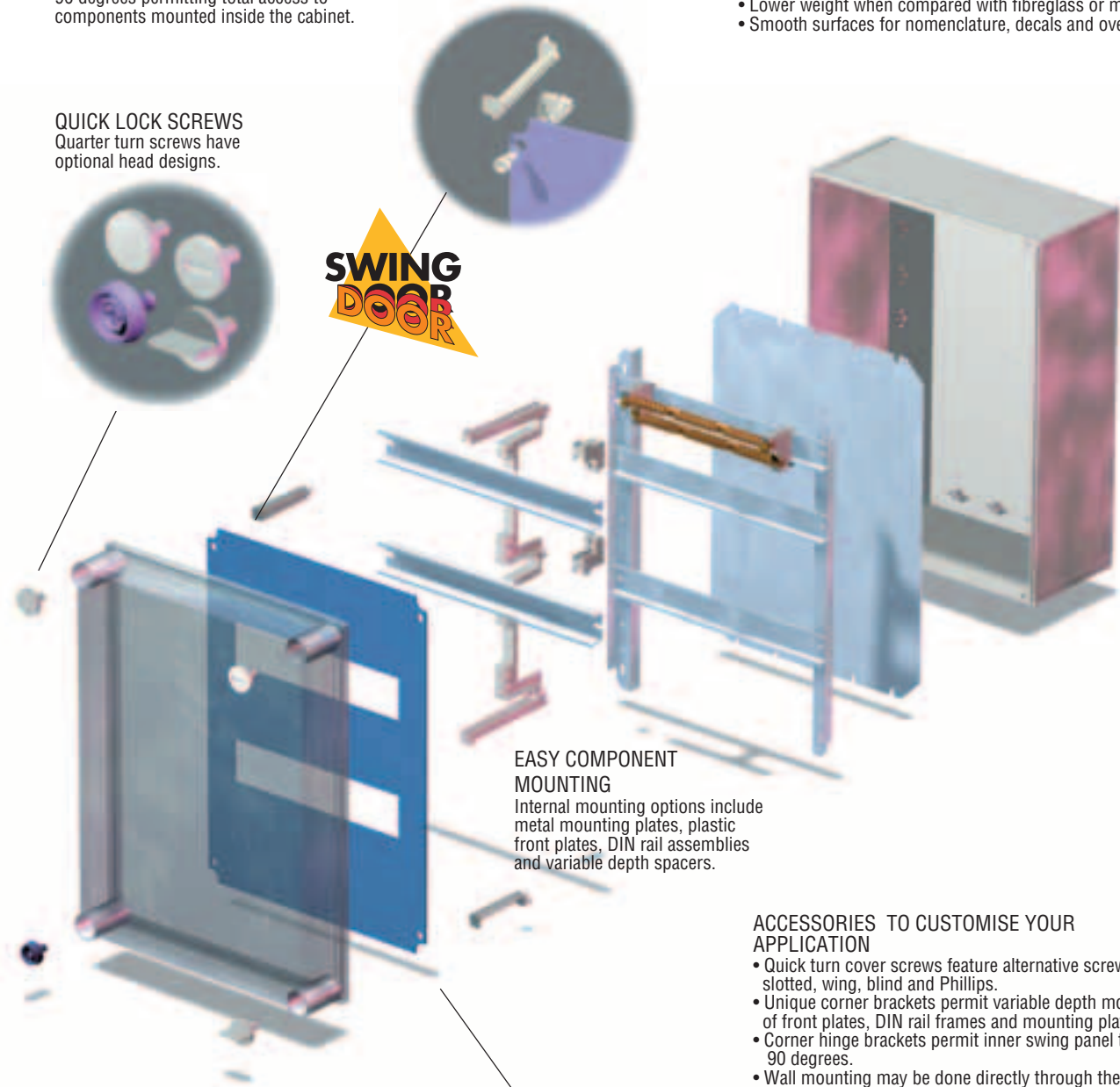

**EASY COMPONENT MOUNTING**

Internal mounting options include metal mounting plates, plastic front plates, DIN rail assemblies and variable depth spacers.

**ACCESSORIES TO CUSTOMISE YOUR APPLICATION**

- Quick turn cover screws feature alternative screw heads: slotted, wing, blind and Phillips.
- Unique corner brackets permit variable depth mounting of front plates, DIN rail frames and mounting plates
- Corner hinge brackets permit inner swing panel to open 90 degrees.
- Wall mounting may be done directly through the rear of an enclosure. Sealing plugs maintain the NEMA rating. Alternatively, optional wall mounting feet may be added using the brass mounting inserts on the rear of the enclosure.
- Inspection windows provide access to components, yet maintain IP ratings.

**SPACE AND MORE SPACE**

Unique corner pod design leaves maximum mounting space without limiting accessories.







Moulded in place, perimeter gasket allows full enclosure base opening (no door return to reduce opening.)

Depth increase with enclosure size. Two optional 100mm high covers increase overall usable depth.

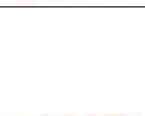

Pat.Reg. 400865

# FIBOX SPACE LINK

FIBOX SPACE LINK PC: IP 65		Z	C	Please order separately: Enclosure base, cover and screws QUICK SET. (see page 60), for EKI 63 and EKI 64, 2 x QUICK SET.		B x A
		mm	mm	ORDER SYMBOL	ORDER SYMBOL	L x S
				Grey cover	Smoked transparent cover	mm
EKI 23		170	158	Base: EKI 23-2 EKI 23-4 Cover: EKI 23/40G	Base: EKI 23-2 EKI 23-4 Cover: EKI 23/40T	B x A 260 x 160  L x S 272 x 172
EKI 33		170	158	Base: EKI 33-2 EKI 33-4 Cover: EKI 33/40G	Base: EKI 33-2 EKI 33-4 Cover: EKI 33/40T	B x A 260 x 260  L x S 272 x 272
EKI 43		170 230	158 218	Base: EKI 43-5A EKI 43-4 Cover: EKI 43/40G EKI 43/100G	Base: EKI 43-5A EKI 43-4 Cover: EKI 43/40T EKI 43/100T	B x A 360 x 260  L x S 372 x 272
EKI 44		170 +100	158 +100	Base: EKI 44-4 Cover: EKI 44/40G EKI EXT 44 Extension frame adds 100 mm depth, use many. See page 64.	Base: 44-4 Cover: EKI 44/40T EKI EXT 44	B x A 360 x 360  L x S 372 x 372
EKI 63		170	158	Base: EKI 63-6 Cover: EKI 63/40G	Base: EKI 63-6 Cover: EKI 63/40T	B x A 560 x 260  L x S 572 x 272
EKI 64		210 270	198 258	Base: EKI 64H - 4EPA EKI 64H - 6 Cover: EKI 64/40G EKI 64/100G	Base: EKI 64H - 4EPA EKI 64H - 6 Cover: EKI 64/40T EKI 64/100T	B x A 560 x 360  L x S 572 x 372

External height **Y** External width **X** External depth **Z** Free internal mounting height **C** Mounting plate assembly **B** x **A** Wall mounting **L** x **S**

# FIBOX SPACE LINK

## FIBOX SPACE LINK - LARGE FLANGE OPENINGS FOR EASY ASSEMBLY

### COMPREHENSIVE ASSEMBLY SYSTEM

- New quick-link system plus a more rugged flange opening design making it easier to connect enclosure assemblies together.
- Flange support system works with popular bus bar systems (ABB, Wohner, Weber, etc.) designed for 5 x 20 and 10 x 30 mm copper bars.
- New DIN rail frames ease DIN module mounting and feature front plate corner brackets.
- Inspection windows with standard DIN 17.5/45 mm openings. New sizes include 377 x 331 mm and 331 x 277 mm.

### EXTENSION FRAMES

Available in 400 x 400 mm and when stacked create additional depth in 100mm increments., for example, 170mm, 270mm, 370mm, etc.

### QUICK-LINK SYSTEM

Assembly of the enclosures faster than ever.

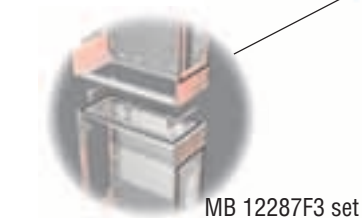

### 60 MM BUS-BAR SYSTEM

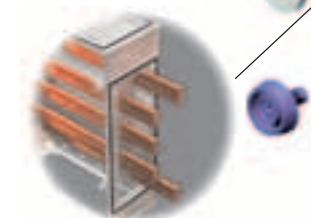

### ACCESSORIES TO CUSTOMIZE YOUR APPLICATION

- Quick turn cover screws feature alternative screw heads: slotted, wing, blind and Phillips.
- Unique corner brackets permit variable depth mounting of front plates, DIN rail frames and mounting plates
- Corner hinge brackets permit inner swing panel to open 90 degrees.
- Wall mounting may be done directly through rear of enclosure. Sealing plugs maintain the NEMA rating. Alternatively, optional wall mounting feet may be added using the brass mounting inserts on the rear of the enclosure.
- Inspection windows provide access to components, while maintaining NEMA ratings.
- Hinges, spacers, ventilators, etc.
- Flange plates with knockouts or blank.
- Variety of cable glands, strain relief and conduit fittings.



Pat.Reg. 400865

### MOUNTING RAILS AND PLATES

Internal mounting options include metal mounting panels, blue polycarbonate front plates, DIN rail assemblies with variable depth spacers.

### SNAP-IN SYSTEM

Fastest way to assemble the flanges.

FIBOX SPACE LINK



# FIBOX SPACE LINK

## SYMBOLS AND ABBREVIATIONS

- Y** External height
- X** External width
- Z** External depth
- C** Free internal mounting height
- B** Mounting plate assembly
- A** Mounting plate assembly
- L** Wall mounting
- S** Wall mounting

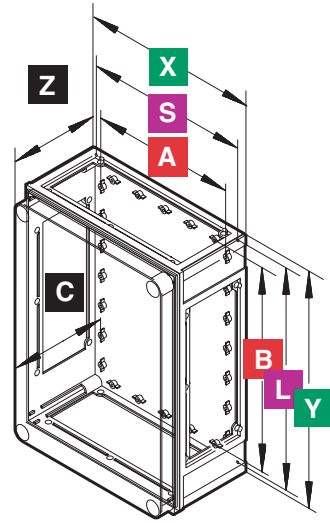

FP 12017 fastening lug measures

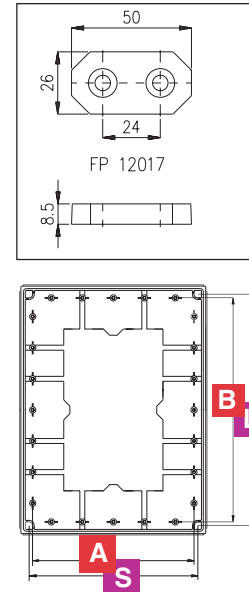

## QUICK SET

Screw set for Space Link and Quick includes:

- 4 x CS 12137 cover screws head, blue
- 4 x MSM PT 5x10 mounting plate screw
- 4 x SP 12087 internal corner plug, red

(4 x) CS 12137

(4 x) MSM PT 5x10

(4 x) SP 12087

Please order one QUICK SET for each SPACE LINK enclosure except 2 for EKI 63 and EKI 64.

## ASSEMBLY OF SPACE LINK ENCLOSURES

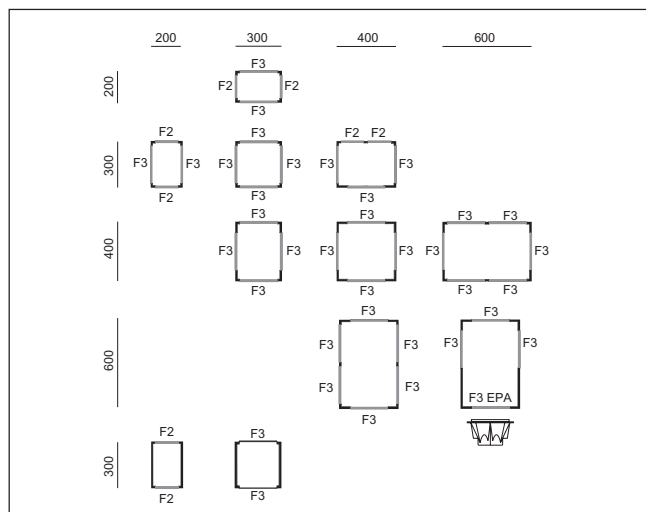

## POLYCARBONATE FLANGES

Ordering symbol	Size	Openings
F3/12014	F3	no opening
F3/12022	F3	12xPg16/9 + 7xPg16
F3/12088	F3	4xPg36/29 + 4xPg16
F3/12028	F3	4xPg21 + 9xPg16 = for plate size 2 in EK range
F3/12187	F3	6 x M20/M25, 4 x M25/M32
F3/12023	F3	C-opening (SFS)
F3/EPA	F3/EPA	C-opening (SFS) incl. MB 12288 plate + 2xFA 12114
F2/12015	F2	no opening
F2/12042	F2	6xPg16/9 + 5xPg16
F2/12041	F2	4xPg16 + 3xPg21
F2/12089	F2	4xPg 16+3xPg 29
F2/12069	F2	2xPg 36+1xPg 16

**EXTENSION FRAME**  
In size 400 x 400 mm  
allow unlimited depth  
170mm,  
270mm,  
370mm  
470 mm etc...

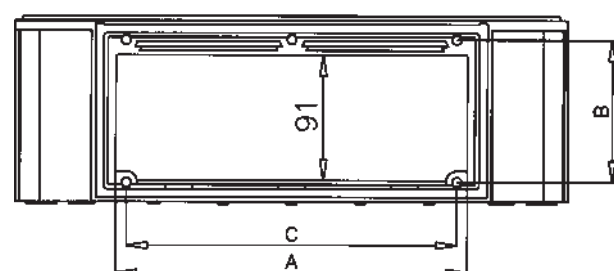
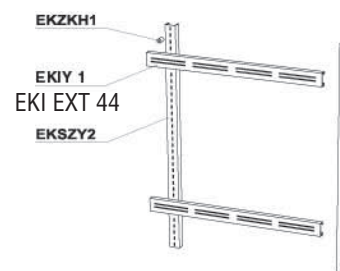

DIMENSIONAL DRAWINGS OF THE FIBOX EKI FLANGE OPENINGS F2 AND F3

TYPE	A	B	C
F2	155	102	140
F3	255	102	240

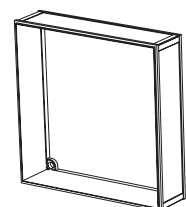



## TECHNICAL INFORMATION FOR SPACE LINK ENCLOSURES

PROPERTY	POLYCARBONATE (PC)	CONFORMITY TO STANDARDS
Ingress Protection (EN 60529)	IP65	<b>USA</b> Enclosures for Electrical Equipment PC: UL Type 1, 3R (UL 50/508) NEMA 1, 4, 4X, 12 and 13
Impact Resistance (EN 50102)	IK 08	<b>Canada</b> Industrial Control Equipment Enclosures for Electrical Equipment/ULc
Temperature Range (short term)	Celsius: -40° .. 120°C Fahrenheit: -40° .. 250°F	<b>Europe</b> Enclosures for Switch Gear and Control Gear Assemblies EN 50298:1998
Temperature Range (continuous)	Celsius: -40° .. 80°C Fahrenheit: -40° .. 175°F	<b>Europe</b> Safety of Information Technology Equipment EN 60950
Electrical Insulation	Totally insulated <input type="checkbox"/>	<b>Australia</b> Enclosures for switch gear and control gear AS 3132-1991
Light Grey Parts Color	RAL 7035	
Transparent Clear PC Cover	Industry Grey	
Screws Head CS (PC)	Smoked Grey	
Gasket	RAL 5023 Blue	
Enclosure Flammability Rating	PUR/EPDM	
Glow Wire Test	UL94-5V	UL 746 C 5 in. vertical flame test
Non-toxicity	960°C	IEC 695-2-1, Self-extinguishing
UV resistance	Halogen Free	DIN/VDE 0472, Part 815
Chemical Resistance *	UL 508 720 hours in "Weatherometer" Good	

## TECHNICAL INFORMATION FOR QUICK ENCLOSURES







PROPERTY	POLYCARBONATE (PC)	ABS	CONFORMITY TO STANDARDS
Ingress Protection (EN 60529)	IP 66/IP67	IP 66/IP67	<b>USA</b> Enclosures for Electrical Equipment PC: UL Type 1, 3R (UL 50/508) NEMA 1, 4, 4X, 12 and 13
Impact Resistance (EN 50102)	IK 08	IK 08	<b>Canada</b> Industrial Control Equipment Enclosures for Electrical Equipment/ULc
Temperature Range (short term)	Celsius: -40° .. 120°C Fahrenheit: -40° .. 250°F	-40° .. 80°C -40° .. 175°F	<b>Europe</b> Enclosures for Switch Gear and Control Gear Assemblies EN 50298:1998
Temperature Range (continuous)	Celsius: -40° .. 80°C Fahrenheit: -40° .. 175°F	-40° .. 60°C -40° .. 140°F	<b>Europe</b> Safety of Information Technology Equipment EN 60950
Electrical Insulation	Totally insulated <input type="checkbox"/>	Totally insulated <input type="checkbox"/>	<b>Australia</b> Enclosures for switch gear and control gear AS 3132-1991
Light Grey Parts Color	RAL 7035	RAL 7035	
Transparent Clear PC Cover	Industry Grey	Industry Grey	
Screws Head CS (PC)	Smoked Grey	Smoked Grey	
Gasket	RAL 5023 Blue	RAL 5023 Blue	
Enclosure Flammability Rating	PUR/EPDM	PUR/EPDM	
Glow Wire Test	UL94-5V	UL94HB	UL 746 C 5 in. vertical flame test
Non-toxicity	960°C	650°C	IEC 695-2-1, Self-extinguishing
UV resistance	Halogen Free	Halogen Free	DIN/VDE 0472, Part 815
Chemical Resistance *	UL 508 720 hours in "Weatherometer" Good	Good	

Data subject to change without notice. \*Consult separate raw material data for more detailed information

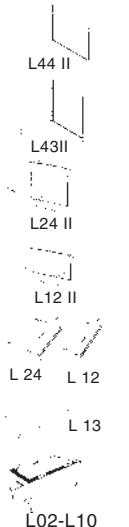
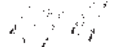
## ACCESSORIES FOR CAB -, QUICK AND SPACE LINK ENCLOSURES

Product	Order symbol	Size mm	
Swing door/ front plates (aluminium)	FP A 23 FP A 33 FP A 43 FP A 44 FP A 54 FP A 63 FP A 64	168x268 268x268 368x268 368x368 468x368 568x268 568x368	
Front plates	FP 12-23 FP 12-33 FP 12x2-33 FP 12x2-43 FP 12x2-43 FP* FP 12x3-43 FP 18x2-54 FP 12x3-63 FP 18x3-64	178 x 278 278 x 278 278 x 278 378 x 278 378 x 278 378 x 278 478 x 378 578 x 378 578 x 378	
Front plates, black (ABS)	FP 23 FP 33 FP 43 FP 44 FP 54 FP 63 FP 64	268 x 176 276 x 268 376 x 268 376 x 368 476 x 368 576 x 268 576 x 368	
*) Swing door kit for front plates and swing door	MB 12225 MB 12225 AL*)		*) Use with FP A front plates
DIN rail frame Incl. A pair of metal profile bar and moun- ting screws and front plate holders	DRF 23 DRF 33 DRF 43/44 DRF 54 DRF 63/64	170 270 370 470 570	
DIN-rails/Banks DIN 35	EKIV 17 EKIV 27 EKIV 37 EKIV 47	166 266 366 466	
Mounting plates (Zinc plates metal)	EKIV 23 EKIV 33 EKIV 43 EKIV 44 EKIV 54 EKIV 63 EKIV 64	170 x 270 270 x 270 370 x 270 370 x 370 470 x 370 570 x 270 570 x 370	

## ACCESSORIES FOR CAB - AND QUICK ENCLOSURES

Product	Order symbol	Size mm	
Inspection windows 	L44 II	377 x 331	
	L43 II	331 x 277	
	L24 II	248 x 218	
	L12 II	248 x 128	
	L24	248 x 218	
	L12	248 x 128	
	L13	257 x 108	
	L10	199 x 77	
	L08	162 x 77	
	L06	130 x 77	
	L04	96 x 77	
	L02-L10	L02	60 x 77
Front plates for windows L12 and L24 	B12 10621-45 B24 10620-45	12 modules 24 modules 1 module = 17,5 mm	
Cover screws heads 	Blue CS 12137		
	Grey SS 12136		
	Grey HS 12112		
	Grey BS 12138		
Hinge set <i>Only to CAB</i>	MB CH SET		
Latch set <i>Only to CAB</i>	MB CL SET		
Hinge set <i>Only to QUICK</i>	PAT 12040		
Wall fastening lug  Set of four, incl screws M6x10	FP 12017		
Corner plug 	SP 12087		
Key 	MB 12235		
DIN rail support	FP 12190		
Spacers	FA 12053 FA 12052 MB 10686 set		
Mounting screws	MSM PT 5x10		
Ventilation device	MB 10564 II MB 10631		
Water plug	MB 12189		
Pole mount set 	PM 60 PM 120		

Product	Order symbol	Size mm	
Bush-bar support flange	BBSF		
Support flanges 	F2/12291 F3/12290		
PE bus-bar, DIN-rail clip-on, blue	MS BAR 7 B		
N bus-bar, DIN-rail clip-on, green/yellow	MS BAR 7 GY		
Terminal support, DIN-rail clip-on	MS TS		
Mounting screw for MS TS. Order separately.	KN 2.9x9.5		
PE/N terminal bus-bar 25+ 10 mm <sup>2</sup>	MS BAR 2+18		
PE/N terminal bus-bar 35+ 10 mm <sup>2</sup>	MS BAR 3+24		
PE/N terminal bus-bar 10 mm <sup>2</sup>	MS BAR 96		
Terminal bus-bar clamp, 25 mm <sup>2</sup>	MS BAR CLAMP		
Terminal bus-bar clamp, 35 mm <sup>2</sup>	MR 26145		

## Cable entry direct mount to flange opening

Product	Order symbol	Size mm	
For F3-size flange open.	F3/12101	2 x 30-60 mm cables	
For F2-size flange open.	F2/12102	1 x 30-60 mm cables	
Connect. kit	MB F3F2	For F2/12101 and F3/12101	
Cable gasket	MK 10428	28-60 mm cables	

## Cable entry with cable gasket for gland plate F3/EPA

Product	Order symbol	Size mm	
Cable entry with cable gasket	HIBOX 16	1 x 37-62 mm cables	
Cable entry with two cable gasket	DSHIBOX 26	2 x 37-62 mm cables	
Cable entry kit	F3/EPA	Connecting HIBOX/DSHIBOX to EKI bases	

## Cable entry for gland plate F3/EPA

Product	Order symbol	Size mm	
Cable entry	EPA 2160	1 x 28-60 mm	
Cable entry	EPA 2260	2 x 28-60 mm	
Connector set	MB 10670	Size 2 flange opening	
Gland plate gasket	MK 10438	Size 2 flange opening	
Cable gasket 	MK 10428	28-60 mm cables	



# FIBOX

## CARDMASTER

FIBOX CARDMASTER

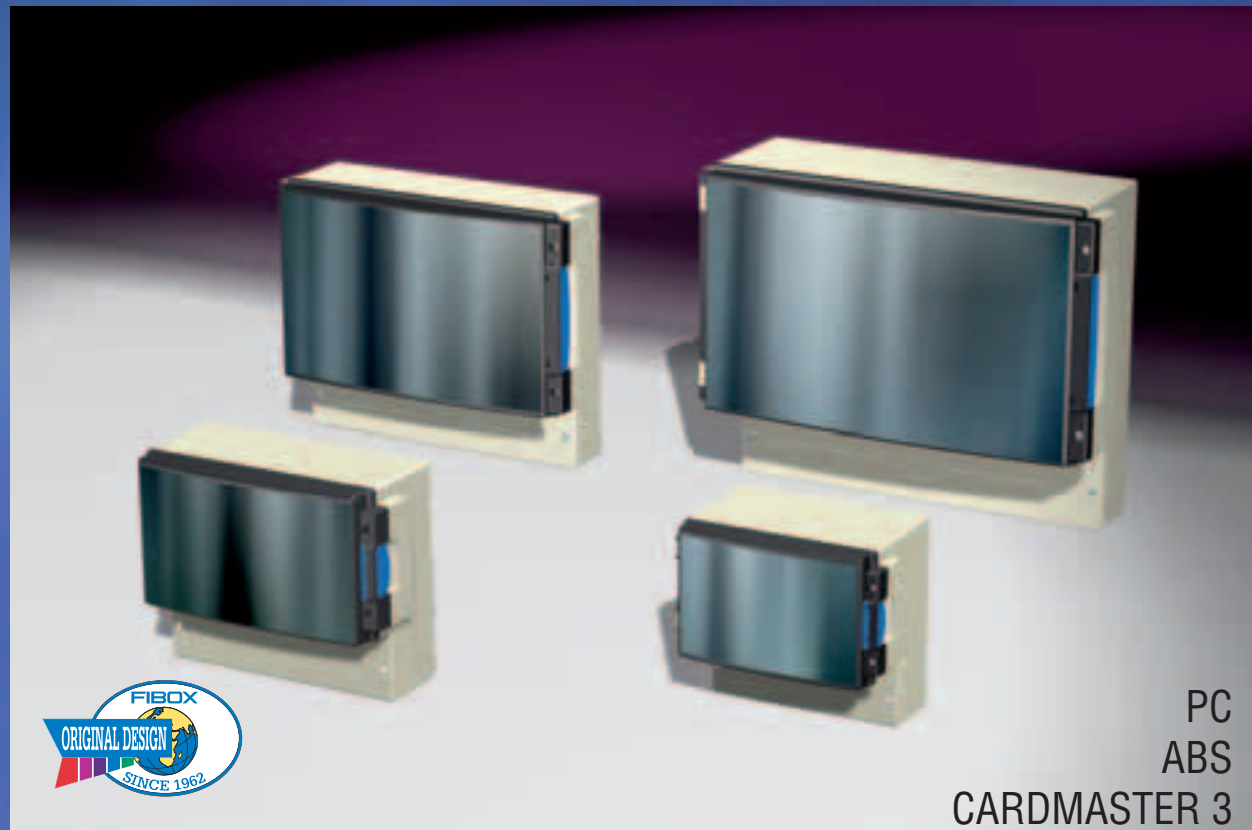

A new generation of FIBOX CARDMASTER enclosures, featuring improved design and colours, is available in polycarbonate and ABS. Designed for use with modular components, the FIBOX CARDMASTER 3 range is ideal for packaging instrumentation, measurement, monitoring and process control equipment. The enclosure has built in PCB card guides and a separate terminal wiring compartment. Hinged transparent covers have quick release latches. All sizes available in either impact resistant polycarbonate or ABS. New accessory front plate frame also available.



# FIBOX CARDMASTER 3

Features

**Ecology also in design**  
more mounting pods and no brass inserts for better recycling

**50 % bigger opening**  
between two compartments

**More usable mounting space**  
in all corners for better utilisation of PCB's

**Instrumentation compartment**  
Smoked grey transparent cover with textured sides

**Quick release latch**  
Ergonomical, easy to operate quick release latch with improved operation. Degree of protection IP 65. Additional locking possible with self-cutting screws

**Terminal compartment**  
Knock-outs for easy wiring from both below and back of the enclosures

**50 % more space for terminals**  
Standard terminals can be used

Three wall mounting alternatives

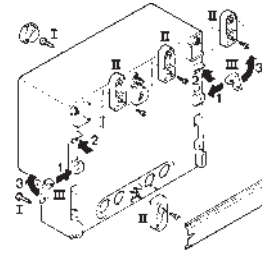

For 17/16 and 21/18 3

CARDMASTER 3 PC AND ABS ENCLOSURE PC: IP 65, IK08/IK07 ABS: IP 65, IK07	Z mm	C mm	Including: Enclosure base, transparent cover, termination compartment cover, polyamide hinges, locking devices, and 8 mounting screws		Including: Enclosure base, terminal compartment cover, and 8 mounting screws. (A transparent cover and hinges are not included.)		B X A L X S mm
			ORDER SYMBOL	ORDER SYMBOL	ORDER SYMBOL	ORDER SYMBOL	
17/16-LC3 17/16-L3 Y X X 166 mm 160 mm	80	58			PC 17/16-LC3		See www.Fibox.com for dimensional drawings.
	80	58			ABS 17/16-LC3		
	104	58			PC 17/16-LFC3		
	106	84	PC 17/16-L3				
17/16-C3 17/16-3 Y X X 166 mm 160 mm	105	86			PC 17/16-C3		
	105	86			ABS 17/16-C3		
	119,5	86,7			PC 17/16-FC3		
	134	113	PC 17/16-3				
21/18-C3 21/18-3 Y X X 213 mm 185 mm	87	71			PC 21/18-C3		
	87	71			ABS 21/18-C3		
	102	71			PC 21/18-FC3		
	118	97	PC 21/18-3				
28/28-0 II 28/28-D II Y X X 280 mm 280 mm	153	150	PC 28/28-0 II				See www.Fibox.com for dimensional drawings.
	153	150	ABS 28/28-0 II				
	154	84			PC 28/28-D II		
	154	84			ABS 28/28-D II		
			Remarks: Size 28/28-0 II including: Enclosure base, (PC with knock-outs), <b>open</b> smoked transparent cover (SOLID FRAME), cover screws, 4 mounting screws, and 4 mounting screws for mounting plate.	Remarks: Size 28/28-D II including: Enclosure base, (PC with knock-outs), <b>closed</b> smoked transparent cover (SOLID FRAME), cover screws, 4 mounting screws, and 4 mounting screws for mounting plate.			

External height **Y** External width **X** External depth **Z** Free internal mounting height **C** Mounting plate assembly **B X A** Wall mounting **L X S**

REMOVING PRODUCT

# FIBOX CARDMASTER 3

## SYMBOLS AND ABBREVIATIONS

- Y** External height
- X** External width
- Z** External depth
- C** Free internal mounting height
- B** Mounting plate assembly
- A** Mounting plate assembly
- L** Wall mounting
- S** Wall mounting

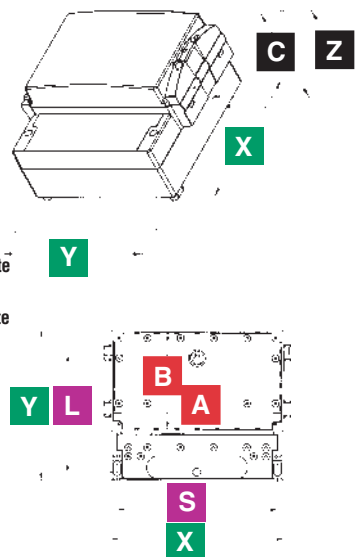

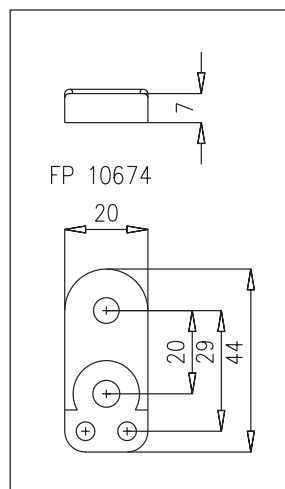

FP 10674 fastening lug measures

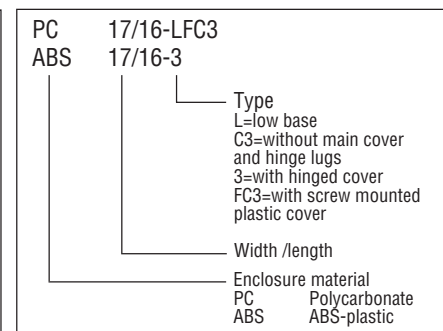

CARDMASTER 3

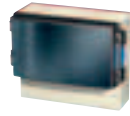
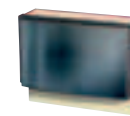

CARDMASTER PC AND ABS ENCLOSURE PC: IP 65, IK08/IK07 ABS: IP 65, IK07	Z mm	C mm	Including: Enclosure base, transparent cover, termination compartment cover, polyamide hinges, locking devices, and 6 mounting screws		Including: Enclosure base, termination compartment cover, front plate, and 6 mounting screws	
			ORDER SYMBOL		ORDER SYMBOL	
			Transparent cover		No main cover	
						B X A L X S mm
21/18-1  Y X X 185 mm 213 mm  Remarks: USA: Incl. FP 21/18 and PC with 3 x 0.85" knock-outs.	113	91	PC 21/18-3 USA			See www.Fibox.com for dimensional drawings.
30/25-3 30/25-C3  Y X X 256 mm 296 mm  Remarks: USA: Incl. FP 30/25 and PC with 5 x 0.85" knock-outs.	123 123 123	103 103 103	PC 30/25-3 ABS 30/25-3 PC 30/25-3 USA		PC 30/25-C3 ABS 30/25-C3	See www.Fibox.com for dimensional drawings.
36/31-3 36/31-C3  Y X X 316 mm 363 mm  Remarks: USA: Incl. FP 36/31 and PC with 2 x 0.85" and 2 x 1.09" knock-outs.	162 162 162	139 139 139	PC 36/31-3 ABS 36/31-3 PC 36/31-3 USA		PC 36/31-C3 ABS 36/31-C3	See www.Fibox.com for dimensional drawings.

FIBOX CARDMASTER



# FIBOX CARDMASTER

## TECHNICAL INFORMATION FOR CARDMASTER 3

PROPERTY	POLYCARBONATE (PC)	ABS	CONFORMITY TO STANDARDS (UL, CSA, CE, Lloyds, BV, FI)
Ingress Protection (EN 60529)	IP65	IP65	<b>USA</b> Enclosures for Electrical Equipment PC: UL Type 1 and 12K (UL 50/508) PC/ABS: NEMA 1, 4, 4X, 6, 12 and 13
Impact Resistance (EN 50102)	IK 08/IK 07	IK 07	<b>Canada</b> Industrial Control Equipment Enclosures for Electrical Equipment/ULc
Temperature Range (short term)	Celsius: -40°...120°C Fahrenheit: -40°...250°F	-40°...80°C -40°...175°F	<b>Europe</b> Enclosures for Switch Gear and Control Gear Assemblies EN 50298:1998
Temperature Range (continuous)	Celsius: -40°...80°C Fahrenheit: -40°...175°F	-40°...60°C -40°...140°F	<b>Europe</b> Safety of Information Technology Equipment EN 60950
Electrical Insulation	Totally insulated <input type="checkbox"/>	Totally insulated <input type="checkbox"/>	<b>Australia</b> Enclosures for switch gear and control gear AS 3132-1991
Light Grey Parts Colour	RAL 7035 Industry Grey	RAL 7035 Industry Grey	
Transparent Clear PC Cover	Smoked Grey	Smoked Grey	
Latches (PA)	RAL 5023 Blue	RAL 5023 Blue	
Gasket	PUR/EPDM	PUR/EPDM	
Enclosure Flammability Rating	UL94-5V	UL94HB	UL 746 C 5 in. vertical flame test
Glow Wire Test	960°C	650°C	IEC 695-2-1, Self-extinguishing
Non-toxicity	Halogen Free	Halogen Free	
UV resistance	UL 508 720 hours in "Weatherometer"		
Chemical Resistance *	Good	Good	

Data subject to change without notice. \*Consult separate raw material data for more detailed information

## ACCESSORIES

Product/size	Order symbol	Size mm		Product/size	Order symbol	Size mm	
Front plate	FP 17/16 FP 21/18 FP 28/28 FP 30/25 FP 36/31	160 x 100 207 x 119 254 x 254 290 x 190 351 x 225		Set of hinges & latches	SET 17/16-21/18-3 SET 30/25-3 SET 36/31-3		
Back panels	MP 17/16 MP 21/18 MP 30/25 MP 36/31	136 x 133 200 x 142 282 x 215 345 x 258		DIN-rail support	MB 20064 SET		
Cover	CM 17/16-3T CM 21/18-3T CM 30/25-3T CM 36/31-3T	166 x 106 x 29 213 x 125 x 30 296 x 196 x 36 363 x 271 x 36		Frame front plate, closed IP 65	FC PC 17/16 FC PC 21/18	160 x 100 203 x 115	
Wall mounting lug 17/16-21/18	FP 10674						



# FIBOX<sub>EX</sub>

FIBOX EX

FIBOX ALX  
ENCLOSURES

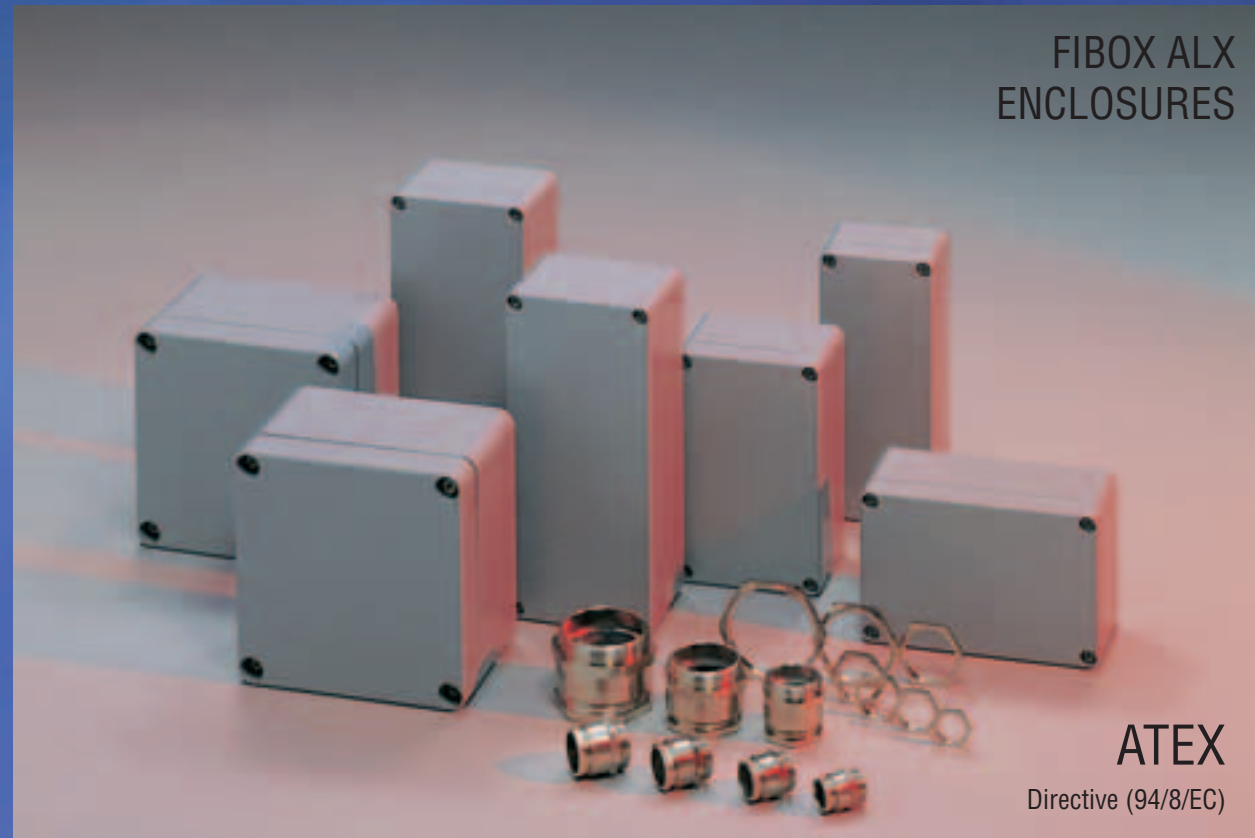

ATEX  
Directive (94/8/EC)

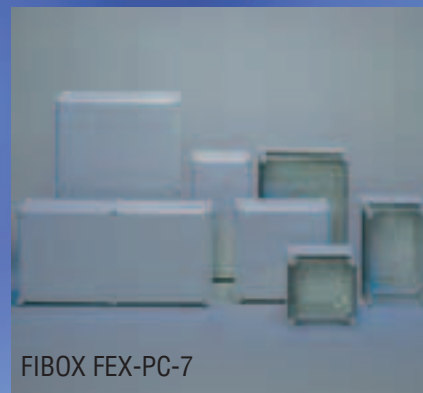

FIBOX FEX-PC-7



FIBOX PEX



Fibox EX enclosures are made for use in hazardous areas. They are designed, tested and manufactured to international standards. The certificates are issued by the manufacturer under licence from a test authority.

All certified products are labelled clearly in compliance with the certification.

An enclosure with Component Certification will achieve the specified degree of safety in use when selected, assembled and installed correctly. The Component Certification establishes the acceptability of the empty enclosure for use as a component part of equipment which is certified by a Certificate of Conformity. Only equipment with a Certificate of Conformity should be installed in hazardous areas.

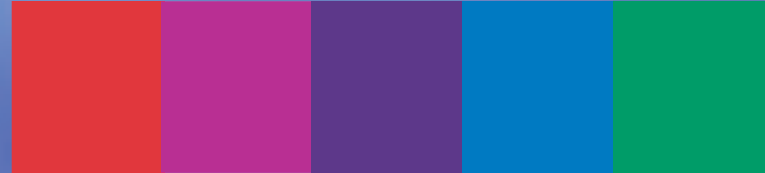

## FIBOX ALX

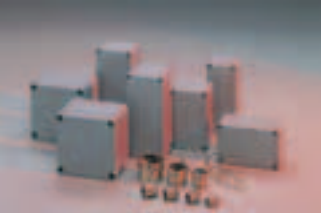
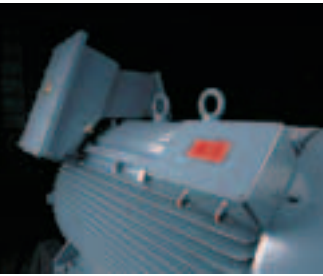
FIBOX ALX ALUMINIUM ENCLOSURE At least IP 54, IK 08	Y mm	X mm	Including: Enclosure base, cover, cover screws, mounting screws, earth screws and earth terminal.			ACCESSORIES
			ORDER SYMBOL	Z mm	C mm	
			Grey cover			
 <p>FIBOX ALX aluminium enclosures for housing terminal blocks, electronic devices and other industrial components. These enclosures are made from high quality, non corrosive aluminium.</p>  <p><b>ATEX</b> VTT 03 ATEX Q 002 VTT 03 ATEX 044U (II 2 G, EEx e II) VTT 03 ATEX 137U (II 3 D) Supplement 1 to VTT 03 ATEX 044U and VTT 03 ATEX 137U</p>	50	45	ALX 050503	32	20	Order symbol   Size mm
	60	66	ALX 060605	46	35	<i>Mounting plate</i> AM 0808   69 x 64 AM 0813   69 x 114 AM 0818   69 x 164 AM 0825   69 x 240 AM 1212   107 x 110 AM 1222   107 x 207 AM 1236   107 x 347 AM 1616   146 x 146 AM 1626   146 x 244 AM 1636   146 x 346 AM 1656   146 x 545 AM 2320   215 x 184 AM 2328   215 x 264 AM 2333   215 x 315 AM 2340   215 x 385 AM 2360   215 x 586 AM 3140   294 x 387 AM 3160   293 x 585
	100	66	ALX 061005	46	35	
	152	65	ALX 061505	46	35	
	82	77	ALX 080806	57	45	
	127	81	ALX 081306	57	45	
	177	81	ALX 081806	57	45	
	252	81	ALX 082506	57	45	<i>Mounting rail DIN 15</i> ARM 0610   15 x 88 ARM 0615   15 x 140 ARM 0808   15 x 65 ARM 0813   15 x 115 ARM 0818   15 x 165 ARM 0825   15 x 240
	125	124	ALX 121208	81	64	
	222	125	ALX 122208	81	64	<i>Mounting rail DIN 35</i> ARH 12   35 x 105 ARH 22   35 x 203 ARH 36   35 x 343 ARH 16   35 x 140 ARH 26   35 x 240 ARH 1636   35 x 340 ARH 1656   35 x 540 ARH 2320   35 x 180 ARH 2328   35 x 260 ARH 2333   35 x 310 ARH 40   35 x 383 ARH 60   35 x 580
	362	125	ALX 123608	81	74	
	163	162	ALX 161609	91	74	<i>Wall mounting lugs</i> MRS 28540 MRS 28541
	263	162	ALX 162609	91	74	

More accessories and dimensions; see page 28.

## TECHNICAL INFORMATION



PROPERTY	AISI CAST ALUMINIUM	CONFORMITY TO STANDARDS
Ingress Protection (EN 60529)	At least IP 54 IP66/IP67	<b>USA</b> Enclosures for Electrical Equipment NEMA 1, 4, 4X, 6 12 and 13 (50/508)
Impact Resistance (EN 50014)	7J	<b>Europe</b> Electrical apparatus for potentially explosive atmospheres <b>EN 50014: 1997 + A1.....A5, General requirements</b> <b>EN 50019: 1997 + A1.....A5, Increased safety "e"</b>
ALX 050503 to ALX 082506		
Temperature Range Celsius (short term)	-50°...140°C	
Temperature Range Fahrenheit (short term)	-60°...285°F	
Temperature Range Celsius (continuous)	-10°...80°C	
Temperature Range Fahrenheit (continuous)	14°...175°F	
Gasket	Silicone	
ALX 121208 to ALX 162609		
Temperature Range Celsius (short term)	-50°...140°C	
Temperature Range Fahrenheit (short term)	-60°...285°F	
Temperature Range Celsius (continuous)	-25°...80°C	
Temperature Range Fahrenheit (continuous)	-13°...175°F	
Gasket	PUR	
Polyester Powder Paint Colour	RAL 7001 grey	
Cover Screws	Stainless Steel	
Chemical Resistance *	Good	

Data subject to change without notice. \*Consult separate raw material data for more detailed information. Also bigger Ex sizes available.

External height **Y** External width **X** External depth **Z** Free internal mounting height **C**

## FIBOX FEX-PC-7

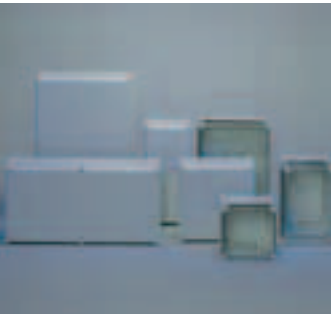
FIBOX FEX-PC-7

FIBOX FEX-PC-7 POLYCARBONATE ENCLOSURE At least IP 54	Y mm	X mm	Including: Enclosure base, cover, cover screws, and mounting screws.			Z x C mm
			ORDER SYMBOL	EAN-code	ORDER SYMBOL	
 <p>The FEX-PC-7 range is suitable for enclosing terminals and other equipment in harsh environmental conditions such as petrochemical sites or off-shore platforms.</p>  <p>CERTIFICATES:            - VTT 03 ATEX Q 002            - VTT 03 ATEX 043U (II 2 G, EEx e II)            - VTT 03 ATEX 136U (II 3 D)            - FIMKO: IP67 to IEC529            - Germanischer Lloyd</p>	190	190	FEX 1919 13 G		FEX 1919 13 T	130 x 115
	190	190	FEX 1919 18 G		FEX 1919 18 T	180 x 165
	280	190	FEX 2819 13 G		FEX 2819 13 T	130 x 115
	280	190	FEX 2819 18 G		FEX 2819 18 T	180 x 165
	380	190	FEX 3819 13 G		FEX 3819 13 T	130 x 115
	380	190	FEX 3819 18 G		FEX 3819 18 T	180 x 165
	280	280	FEX 2828 13 G		FEX 2828 13 T	130 x 115
	280	280	FEX 2828 18 G		FEX 2828 18 T	180 x 165
	380	280	FEX 3828 13 G		FEX 3828 13 T	130 x 115
	380	280	FEX 3828 18 G		FEX 3828 18 T	180 x 165
	560	280	FEX 5628 13 G		FEX 5628 13 T	130 x 115
	560	380	FEX 5638 18 G		FEX 5638 18 T	180 x 165
	Accessories, see pages 43-44.					



## TECHNICAL INFORMATION

PROPERTY	POLYCARBONATE (PC)	CONFORMITY TO STANDARDS
Ingress Protectionat (EN 60529)	At least IP 54 IP66/IP67	<b>Europe</b> Electrical apparatus for potentially explosive atmospheres <b>EN 50014: 1977 + A1...A5, General requirements</b> <b>EN 50019: 1997 + A1...A5, Increased safety "e"</b>
Impact Resistance (EN 50014)	4J	
Temperature Range Celsius (short term) Fahrenheit	-40°...120°C -40°...250°F	
Temperature Range Celsius (continuous) Fahrenheit	-10°...80°C 14°...175°F	
Electrical Insulation	Totally insulated <input checked="" type="checkbox"/>	
Light Grey Parts Colour	RAL 7035	
Industry Grey		
Transparent Clear PC Cover	Clear Transparent	
Cover Screws	RAL 7035	
Cover Screws	Polyamide (PA)	
Gasket	Silicone	
Enclosure Flammability Rating	UL94-V0	UL 746 C 5 in. vertical flame test
Glow Wire Test	960°C	IEC 695-2-1, Self-extinguishing
Non-toxicity	Halogen Free	
UV resistance	UL 508, 720 hours in "Weatherometer"	
Chemical Resistance *	Good	

Data subject to change without notice. \*Consult separate raw material data for more detailed information

External height **Y** External width **X** External depth **Z** Free internal mounting height **C**

**FIBOX PEX**

FIBOX PEX POLYESTER ENCLOSURE At least IP 54	X mm	Y mm	Including: Enclosure base, cover, cover screws, and mounting screws.				ACCESSORIES																																																		
			ORDER SYMBOL		Z mm	C mm																																																			
			Grey cover																																																						
 <p>The FIBOX PEX product family is suitable for enclosing terminals and other electrical equipment in the most demanding environments such as mining or chemical industries.</p>  <p>CERTIFICATES: - PTB: EEx e II</p>	75	80	PEX 080806	55	47	<table border="1"> <thead> <tr> <th>Order symbol</th> <th>Size mm</th> </tr> </thead> <tbody> <tr> <td colspan="2"><i>Mounting plate</i></td> </tr> <tr> <td>PM 0808</td> <td>64 x 69</td> </tr> <tr> <td>PM 0811</td> <td>64 x 99</td> </tr> <tr> <td>PM 0816</td> <td>64 x 149</td> </tr> <tr> <td>PM 0819</td> <td>64 x 179</td> </tr> <tr> <td>PM 1616</td> <td>146 x 146</td> </tr> <tr> <td>PM 1626</td> <td>146 x 244</td> </tr> <tr> <td>PM 2526</td> <td>231 x 240</td> </tr> <tr> <td>PM 2540</td> <td>231 x 383</td> </tr> <tr> <td>PM 4040</td> <td>390 x 385</td> </tr> <tr> <td colspan="2"><i>Mounting rail DIN 15</i></td> </tr> <tr> <td>PRM 0811</td> <td>15 x 99</td> </tr> <tr> <td>PRM 0816</td> <td>15 x 149</td> </tr> <tr> <td>PRM 0819</td> <td>15 x 179</td> </tr> <tr> <td colspan="2"><i>Mounting rail DIN 35</i></td> </tr> <tr> <td>PRH 2526</td> <td>35 x 238</td> </tr> <tr> <td colspan="2"><i>Hinge kit</i> 1 pair includes screws</td> </tr> <tr> <td colspan="2">AH A/B PH A</td> </tr> <tr> <td colspan="2"><i>Mounting foot kit</i></td> </tr> <tr> <td colspan="2">MRS 28540 MRS 28541</td> </tr> <tr> <td colspan="2">11x42 15x50</td> </tr> <tr> <td colspan="2">More accessories and dimensions; see page 28.</td> </tr> </tbody> </table>	Order symbol	Size mm	<i>Mounting plate</i>		PM 0808	64 x 69	PM 0811	64 x 99	PM 0816	64 x 149	PM 0819	64 x 179	PM 1616	146 x 146	PM 1626	146 x 244	PM 2526	231 x 240	PM 2540	231 x 383	PM 4040	390 x 385	<i>Mounting rail DIN 15</i>		PRM 0811	15 x 99	PRM 0816	15 x 149	PRM 0819	15 x 179	<i>Mounting rail DIN 35</i>		PRH 2526	35 x 238	<i>Hinge kit</i> 1 pair includes screws		AH A/B PH A		<i>Mounting foot kit</i>		MRS 28540 MRS 28541		11x42 15x50		More accessories and dimensions; see page 28.		75	110	PEX 081106	55	47
	Order symbol	Size mm																																																							
	<i>Mounting plate</i>																																																								
	PM 0808	64 x 69																																																							
	PM 0811	64 x 99																																																							
	PM 0816	64 x 149																																																							
	PM 0819	64 x 179																																																							
	PM 1616	146 x 146																																																							
	PM 1626	146 x 244																																																							
	PM 2526	231 x 240																																																							
	PM 2540	231 x 383																																																							
	PM 4040	390 x 385																																																							
	<i>Mounting rail DIN 15</i>																																																								
	PRM 0811	15 x 99																																																							
	PRM 0816	15 x 149																																																							
PRM 0819	15 x 179																																																								
<i>Mounting rail DIN 35</i>																																																									
PRH 2526	35 x 238																																																								
<i>Hinge kit</i> 1 pair includes screws																																																									
AH A/B PH A																																																									
<i>Mounting foot kit</i>																																																									
MRS 28540 MRS 28541																																																									
11x42 15x50																																																									
More accessories and dimensions; see page 28.																																																									
75	160	PEX 081606	55	47																																																					
75	190	PEX 081906	55	47																																																					
120	122	PEX 121209	90	75																																																					
120	220	PEX 122209	90	75																																																					
160	160	PEX 161609	90	75																																																					
160	260	PEX 162609	90	75																																																					
160	360	PEX 163609	90	75																																																					
250	255	PEX 252612	120	105																																																					
250	400	PEX 254012	120	105																																																					
405	400	PEX 404012	120	105																																																					

**TECHNICAL INFORMATION**

PROPERTY	POLYESTER	CONFORMITY TO STANDARDS
Ingress Protection (EN 60529)	IP 65 At least IP 54	<b>USA</b> Enclosures for Electrical Equipment NEMA 1, 4, 4X, 6 12 and 13
Impact Resistance (EN 50014)	7J	UL 746 C 5 in. vertical flame test IEC 695-2-1, Self-extinguishing
Temperature Range (short term)	Celsius: -40°...120°C Fahrenheit: -40°...250°F	
Temperature Range (continuous)	Celsius: -10°...80°C Fahrenheit: 14°...175°F	
Electrical Insulation	Totally insulation <input type="checkbox"/>	
Enclosure Flammability Rating	UL94-5V	UL 746 C 5 in. vertical flame test
Glow Wire Test	960°C	IEC 695-2-1, Self-extinguishing
Cover screws	Stainless Steel	
Gasket	EPDM	
Chemical Resistance *	Good	

Data subject to change without notice. \*Consult separate raw material data for more detailed information

External height **Y** External width **X** External depth **Z** Free internal mounting height **C**



**EX CERTIFICATION OF ENCLOSURES**

Fibox EX enclosures are made for use in hazardous areas. They are designed, tested and manufactured to international standards. The certificates are issued by the manufacturer under licence from a test authority. All certified products are labelled clearly in compliance with the certification.

An enclosure with Component Certification will achieve the specified degree of safety in use when selected, assembled and installed correctly. The Component Certification establishes the acceptability of the empty enclosure for use as a component part of equipment which is certified by a Certificate of Conformity. Only equipment with a Certificate of Conformity should be installed in hazardous areas.

Hazardous areas are referred to as they are classified under CENELEC European Norms:

- Zone 0 = Zone in which an explosive gas/air mixture is continuously present or present for long periods.
- Zone 1 = Zone in which an explosive gas/air mixture is likely to occur in normal operation.
- Zone 2 = Zone in which an explosive gas/air mixture is not likely to occur in normal operation and if arises, will only last for a short period.

**EXPLANATION OF CERTIFICATE SYMBOLS**

The following tables can be used as practical quick guides. For more detailed information please contact your local Fibox representative.

**The different EX protection types specified are:**

Protection typ	Symbol	Test Standard
Increased safety	e	EN 50019
Non-sparking	n	-
Flameproof	d	EN 50018
Intrinsically safe	i	EN 50020
Special protection	s	-
Encapsulation	m	EN 50028
Oil immersion	o	EN 50015
Pressurisation	p	EN 50016
Sand or powder filled	q	EN 50017

**Classification of gas groups to IEC standards:**

Gas Group	Representative Gas
I	Methane
II A	Prophane
II B	Ethylene
II C	Acetylene and Hydrogen

**Temperature classification to EN standards of the maximum surface temperature allowed for any part of an apparatus:**

Temperature Class	Max. Surface Temperature
T1	450 °C
T2	300 °C
T3	200 °C
T4	135 °C
T5	100 °C
T6	85 °C

These temperature classifications are applicable only to mounted enclosures which have a Certificate of Conformity.

**CIRCUIT BOARD BRACKET**

Printed circuit boards and mounting plates often need special mounting supports that offer flexibility in positioning the boards across the enclosure body. Mounting supports also raise the board above the enclosure bottom, especially effective when using two sided boards. This circuit board bracket has a standard E1 (IEC 297-3, DIN 41494) Eurocard screw mounting distance of 89 mm (3.5") accepting M2,5 to M4 screws. The bracket can also be used for nonstandard boards by separating the ends of the bracket (a) from the connector bridge (b). If the bracket is not needed, the adapter parts for each individual mounting pod size can be used only for raising the board above the enclosure base level.

CIRCUIT BOARD BRACKET			
ORDER SYMBOL	Standard Mounting Distance mm	inches	Remarks
MB 28086	89	3.5	Adapter for EURONORD, PICCOLO, MINI. Direct mount to EK, SOLID, EKI, ALX, PC-7, PEX.

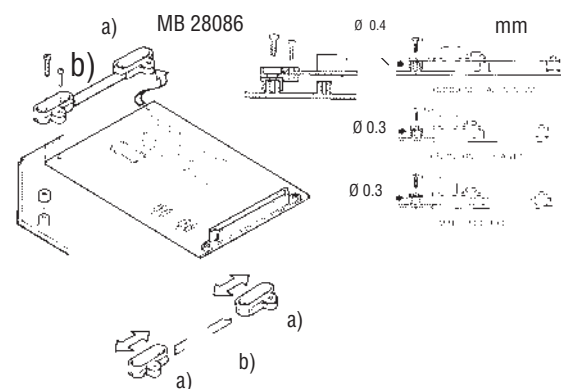

**CUSTOMISATION**

Enclosures can be machined, painted, screen printed and preassembled to meet your customisation requirements. Fibox's service center offers complete CNC machining, hinge mounting, screen printing, assembly and much more. Our wide selection of enclosures and accessories can be customised to create a unique enclosure meeting your application requirements.

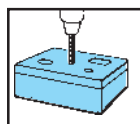



**FIBOX**<sup>®</sup>  
CONTRACT MANUFACTURING





# FIBOX

## WINDOWS

Simple to mount.  
Self-extinguishing,  
impact resistant polycarbonate.

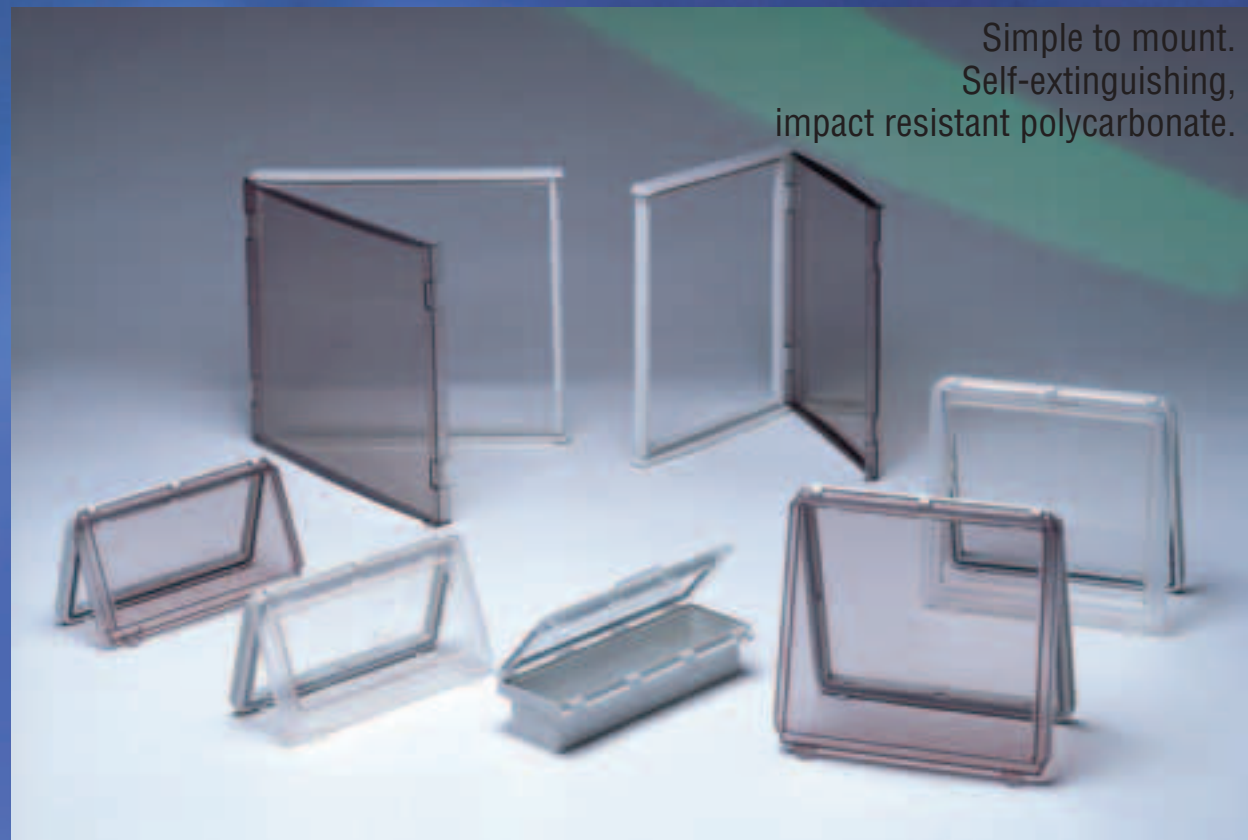

FIBOX SOLID FRAME

FIBOX Inspection Windows permit both viewing and access to IP rating and controls which are surface mounted on plastic or metal enclosures. While providing access, when cover closed, these inspection windows maintain enclosure environmental ratings up to IP 65. Four new second generation windows L12 II, L24 II, L43 II and L44 II, feature transparent smoked grey polycarbonate with textured sides and stylish design.

FIBOX WINDOWS



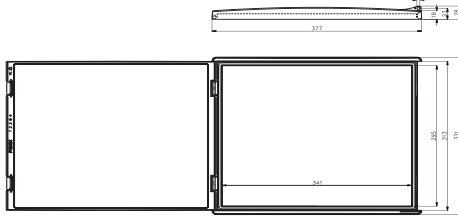
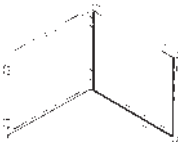
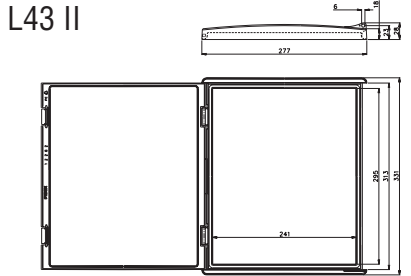
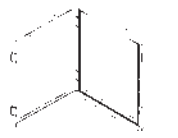
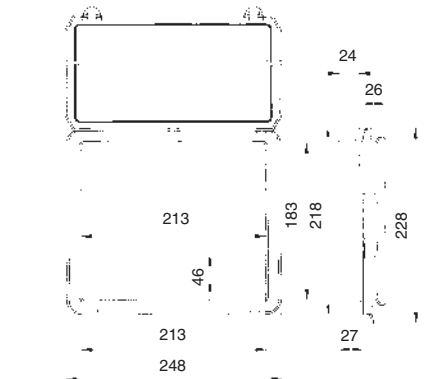
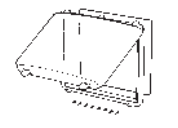
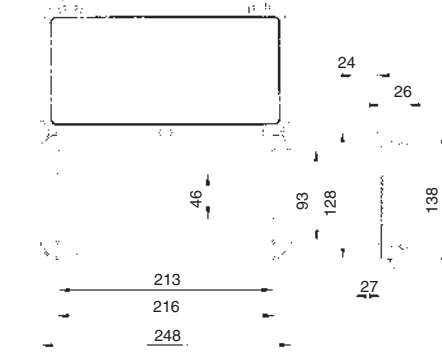
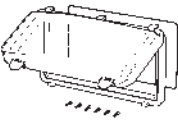
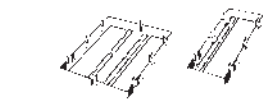

FIBOX INSPECTION WINDOWS	Remarks	IP	Size mm	ORDER SYMBOL	
<p>L44 II</p> 	<p>For 36 modules (1 module = 17,5 mm)</p>  <p>Smoked transparent cover</p>	65	377 x 331	L44 II	
<p>L43 II</p> 	<p>For 26 modules</p>  <p>Smoked transparent cover</p>	65	331 x 277	L43 II	
<p>L24 II</p> 	<p>For 24 modules</p> <p>High cover</p>  <p>Smoked transparent cover</p>	65	248 x 218	L24 II	
<p>L12 II</p> <p>Pat.Reg. 383990</p> 	<p>For 12 modules</p> <p>High cover</p>  <p>Smoked transparent cover</p>	65	248 x 128	L12 II	
<p>FRONT PLATES FOR WINDOWS L12, L 24, L12 II and L24 II</p> 	<p>12 modules 2 x 12 modules</p>	65		B12 10621-45 B24 10620-45	

FIBOX INSPECTION WINDOWS	Remarks	IP	Size mm	ORDER SYMBOL																																			
<p><b>L24</b></p>	<p>For 24 modules</p> <p>Low clear cover</p>	65	248 x 218	L24																																			
<p><b>L12</b></p>	<p>For 12 modules</p> <p>Low clear cover</p>	65	248 x 128	L12																																			
<p><b>L13</b></p>	<p>For 13 modules</p> <p>Clear cover</p>	65	257 x 108	L13																																			
<p><b>L02-L10</b></p> <table border="1"> <thead> <tr> <th rowspan="2">TYPE</th> <th colspan="2">A</th> <th colspan="2">B</th> </tr> <tr> <th>mm</th> <th>in.</th> <th>mm</th> <th>in.</th> </tr> </thead> <tbody> <tr> <td>L02</td> <td>59</td> <td>2.3</td> <td>44</td> <td>1.7</td> </tr> <tr> <td>L04</td> <td>94.5</td> <td>3.7</td> <td>78</td> <td>3.1</td> </tr> <tr> <td>L06</td> <td>129.5</td> <td>5.1</td> <td>114</td> <td>4.5</td> </tr> <tr> <td>L08</td> <td>163</td> <td>6.4</td> <td>146</td> <td>5.7</td> </tr> <tr> <td>L10</td> <td>200</td> <td>7.9</td> <td>183</td> <td>7.2</td> </tr> </tbody> </table>	TYPE	A		B		mm	in.	mm	in.	L02	59	2.3	44	1.7	L04	94.5	3.7	78	3.1	L06	129.5	5.1	114	4.5	L08	163	6.4	146	5.7	L10	200	7.9	183	7.2	<p>For 10 modules</p> <p>For 8 modules</p> <p>For 6 modules</p> <p>For 4 modules</p> <p>For 2 modules</p> <p>Clear cover</p>	54	199 x 77 162 x 77 130 x 77 96 x 77 60 x 77	L10 L08 L06 L04 L02	
TYPE		A		B																																			
	mm	in.	mm	in.																																			
L02	59	2.3	44	1.7																																			
L04	94.5	3.7	78	3.1																																			
L06	129.5	5.1	114	4.5																																			
L08	163	6.4	146	5.7																																			
L10	200	7.9	183	7.2																																			

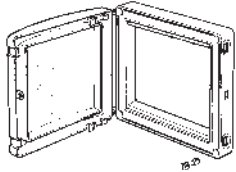
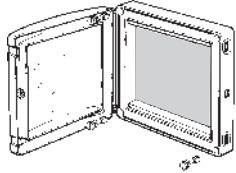
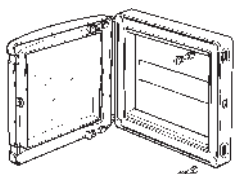
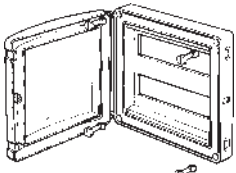

FIBOX SOLID FRAMES	Remarks	Size mm	ORDER SYMBOL	
	Frame, with opening Smoked transparent cover	280 x 280	Cover 28/28-0	
	Frame, no opening Smoked transparent cover	280 x 280	Cover 28/28-D	
	Frame with one DIN opening Smoked transparent cover	280 x 280 x 54	SF PC2828-SG-12-1	
	Frame with two DIN openings Smoked transparent cover	280 x 280 x 54	SF PC2828-SG-12-2	

Data subject to change without notice.

## FEATURES YOU'VE NEVER SEEN BEFORE

Ingress protection: IP 54-IP 65

Temperature range: - 40°C – +120°C

- Chemical resistance to concentrated mineral acids, organic acid, oxidants, deducing agents, neutral /acid salt solutions, grease & oil
- Resistance to U.V. radiation
- Self-extinguishing to UL94
- Non-hygroscopic

Data subject to change without notice.

## CUSTOMISATION

Enclosures can be machined, painted, screen printed and preassembled to meet your customisation requirements. Fibox's service centre offers complete CNC machining, hinge mounting, screen printing, assembly and much more. Our wide selection of enclosures and accessories can be customised to create a unique enclosure meeting your application requirements.

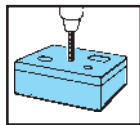

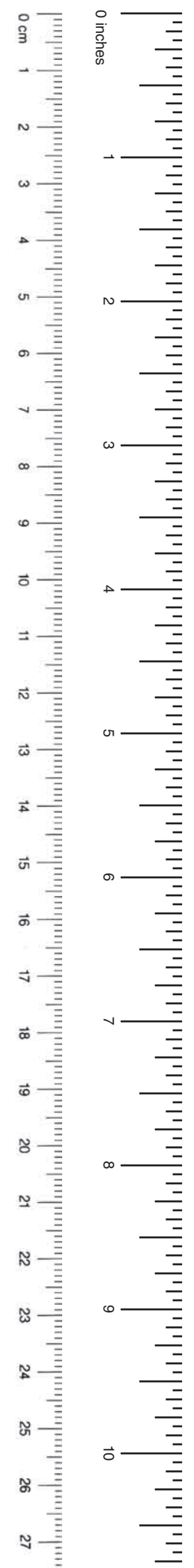

# FIBOX®

www.fibox.com

## Production

Fibox Oy Ab  
Jorvaksenniitty, P.O. Box 16  
FIN-02421 JORVAS, Finland  
Tél. +358 9 2955 31 - Fax +358 9 2955 3200  
E-mail : info@fibox.fi, sales@fibox.fi

Fibox Ltd. Korea  
1381-2, Juan-Dong, Nam-Gu  
Incheon, Post No 402-853  
Republic of Korea  
Tél. +82 32 81 46 742 - Fax +82 32 81 46 077  
E-mail : fibox@kornet.net

## Customer service

FIBOX Ltd.  
3 Primrose Hill Industrial Park  
Orde Wingate Way, Stockton on Tees  
Cleveland TS19 0BJ, England  
Tél. +44 1642 6044 00 - Fax +44 1642 6046 00  
E-mail : sales@fibox.co.uk

Fibox Oy Ab  
Jorvaksenniitty, P O Box 16  
FIN-02421 JORVAS, Finland  
Tél. +358 9 2955 351 - Fax +358 9 2955 3500  
E-mail : info@fibox.fi, sales@fibox.fi

Fibox Inc.  
810 Cromwell Park Drive  
Suite R, Glen Burnie  
MD 21061, USA  
Tél. +1 410 760 9696 - Fax +1 410 760 8686  
Call toll-free  
USA 1 888 342 6987 / 1888 FIBOX US  
E-mail : sales@fiboxusa.com

FIBOX FRANCE Sarl  
28 rue Paul Henri Spaak  
Parc de l'Esplanade  
F-77400 Saint Thibault Des Vignes  
Tél. +33-1-60 21 17 17 - Fax +33-1-60 21 17 18  
E-mail : service.client@fibox.fr

FIBOX GmbH - FSC Germany  
Möllberger strasse 18  
D-32602 Vlotho, Germany  
Tél. +49 5733 87 160 - Fax +49 5733 87 1610  
E-mail : info@fibox.de

FIBOX GmbH - Switzerland  
Industrieareal Jenny  
CH-8866 Ziegelbrücke  
Tél. +41 55 617 2080 - Fax +41 55 617 2089  
E-mail : info@fibox.ch

Fibox Ltd. Korea  
1381-2, Juan-Dong, Nam-Gu  
Incheon, Post No 402-853  
Republic of Korea  
Tél. +82 32 81 46 742 - Fax +82 32 81 46 077  
E-mail : fibox@kornet.net

Fibox Shanghai Ltd.  
2A, 2. etage, Block No. 55-56, 461 Hongcao Road  
Shanghai 200233, China  
Tél. +86 216 495 9922 - Fax +86 216 495 9667  
E-mail : fibox@kornet.net

FIBOX Sp. z.o.o.  
ul. Dzieciola 19  
04-988 Warsaw, Poland  
Tél. +48 22 872 9498 - Fax +48 22 872 9698  
E-mail : info@fibox.pl

# FIBOX®

## ENCLOSURE CATALOGUE Version 3.5 GB



**WEB GUIDE**  
DESIGNERS HELP TOOL

## X-ON Electronics

Largest Supplier of Electrical and Electronic Components

*Click to view similar products for [Racks & Rack Cabinet Accessories](#) category:*

*Click to view products by [Fibox](#) manufacturer:*

Other Similar products are found below :

[M00-PLN](#) [F2420](#) [F2424](#) [8310-1032-SS](#) [9104](#) [PLFF2000](#) [PLFF6000](#) [GP216](#) [PTFA60000LG](#) [H-9163-B](#) [HEH050BA](#) [1427C3](#) [BAS-5104](#) [N-700-2](#) [190-002](#) [HTL10](#) [HTS10](#) [PC-118](#) [PC-780L](#) [PC-79](#) [PC-800](#) [SC4-28](#) [F3024](#) [AKWAMT](#) [PLFF1000](#) [CG3-340S/12](#) [2CWDP36](#) [2CWDP48](#) [2SSHINGE](#) [CP-001BK](#) [CPL19431LG1](#) [R570-004-107](#) [M6123-4007-SS](#) [TS170](#) [531300535](#) [BRX-12290](#) [C4BD3077SBK1](#) [UPS](#) [7-17-14 PLAIN](#) [LP40](#) [5261304-07](#) [CCA26-44-01](#) [706-102](#) [CG3-160G](#) [7112C-PLN ALUM](#) [CM10](#) [TS81](#) [7142](#) [GP134](#) [M6127-4007-SS](#) [PBCOVER](#)